

# POLL PAD

V-2.5.0

user  
guide

STATE OF CALIFORNIA



Humboldt County Office of Elections  
Revised January 2020

 **knowink**  
Innovative Election Solutions

# TABLE OF CONTENTS

<b>Opening Procedures</b>	5
Printer Setup	5
Poll Pad Setup	6
Poll Pad Icons	10
<b>Processing Voters</b>	11
Voter Search	12
Advanced Search	14
Provisional Process	19
Vote By Mail Ballot Sent	21
Vote By Mail Ballot Received	22
Inactive	23
Wrong Polling Place	24
Curbside Voting	25
Assistance Required	26
<b>Closing Procedures</b>	31
Secure Poll Pad Supplies	32
<b>Troubleshooting</b>	34
Charging Poll Pad	35
iOS Software Update	35
Voter Not Found	36
Printer Not Printing	36
Lost Printer Bluetooth Connection	37
<b>Advanced Functions</b>	39
Summary Report	40
<b>Lead Judge Scenarios</b>	41
Cancel Voter Check-in	42
Reprint Receipt	44

meet the

# POLL PAD<sup>®</sup>



- 1 Power Button
- 2 Home Button
- 3 Poll Pad & Plastic Shell
- 4 Stand Arm
- 5 Poll Pad Base
- 6 Camera



- ① Green Case
- ② Poll Pad
- ③ Poll Pad Base
- ④ Lightning to USB Cable & USB Power Adapter
- ⑤ (2) Stylus
- ⑥ Printer
- ⑦ Screen Cloth

## OPENING PROCEDURES | POLL PAD SETUP

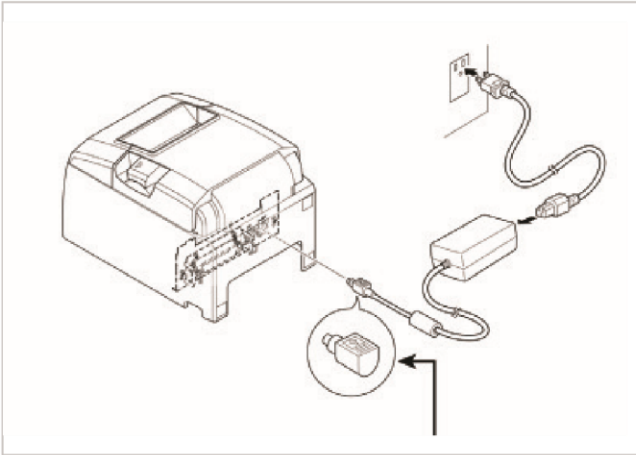

### 1) LOCATE PRINTER

Open the transport case and remove printer, adapter, and power cord.



### 2) CONNECT TO POWER ADAPTER

Connect the power cord to the power adapter.  
NOTE: Ensure secure connection.



### 3) CONNECT TO PRINTER

Plug the connector into the back of the printer.

NOTE: Ensure secure connection.

## OPENING PROCEDURES | POLL PAD SETUP



### 4) PLUG PRINTER INTO OUTLET

Plug the printer into a wall outlet.

NOTE: Make sure your check-in table is close to the wall outlet or you have an extension cord available.



### 5) TURN PRINTER ON

The ON/OFF switch is located on the left side of the printer. If you do not see a green power light on the front panel, check the power cord connections and make sure the outlet has power.



### 6) STAND ARM

To attach the stand arm to the Poll Pad shell, press the buttons on the side of the arm and place in circular opening. Release buttons and rotate the arm until it clicks.



### **7) CONNECT ARM TO BASE**

Place stand arm into Poll Pad base. Once attached, rotate Poll Pad making sure the camera is on top, oriented in a landscape position.



### **8) POWER ON POLL PAD**

Press the power button on the top left edge of the unit until you see the Apple icon, then release. The Poll Pad will power on, and the Poll Pad application will launch automatically. NOTE: Poll Pad will automatically power on if connected to AC power.

## OPENING PROCEDURES | POLL PAD SETUP



### 9) APPLICATION LAUNCHES

Press the application icon at the bottom of the screen.

When the application launches, you will be directed to your county's homepage.



### 10) HOME SCREEN CHECKLIST

- Name of jurisdiction
- Election name and date
- IMPORTANT: Verify polling place is correct
- Checkin Count = 0
- Battery life is close to full (90% or greater)

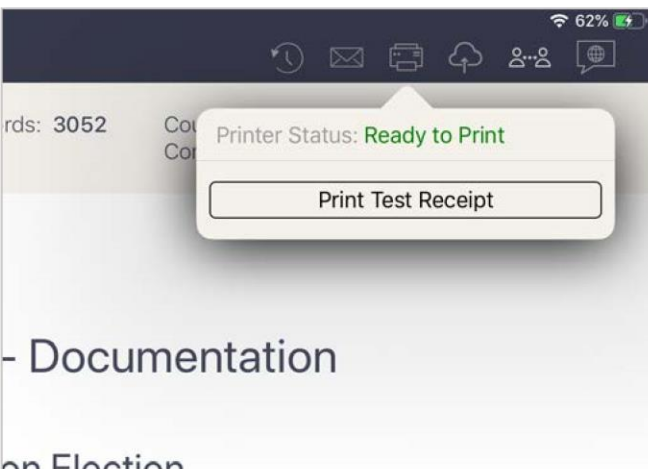

### 11) CONNECT & TEST PRINT

A green printer icon on the Poll Pad means you are connected to the printer.

Press the green printer icon and press Print Test Receipt and a sample receipt will print.

# OPENING PROCEDURES | POLL PAD SETUP



## 12) GET STARTED

At the bottom of the home screen, press GET STARTED.

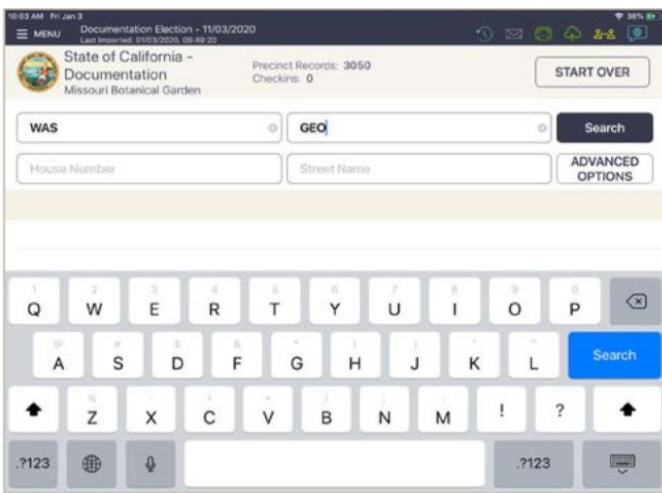



## 13) READY TO PROCESS VOTERS

You are now ready to begin processing voters.

# OPENING PROCEDURES | POLL PAD ICONS



## PRINTER ICONS & COLORS

-  Poll Pad is paired with the printer. A receipt will print out for checked-in voters and those who are in the wrong precinct.
-  Poll Pad recognizes the printer and is currently in the process of pairing with the device.
-  Poll Pad is not paired with the printer. Select the printer icon, followed by Pair and Connect.

# PROCESSING VOTERS

# PROCESSING VOTERS | VOTER SEARCH

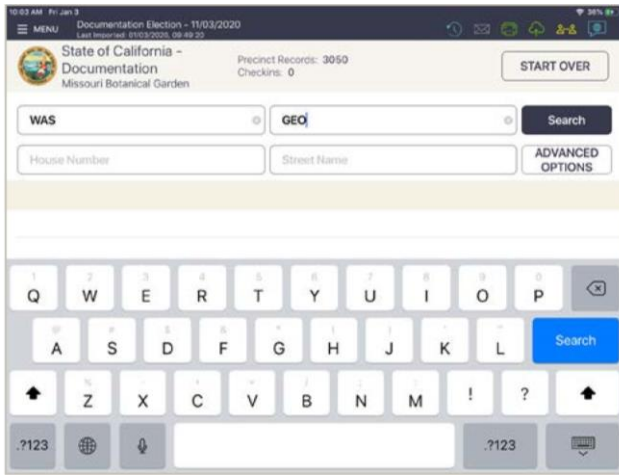

## 1) ENTER VOTER'S NAME

Use the on-screen keyboard to enter the first three (3) letters of the voter's last and first name, then press Search.

To narrow search results, use House Number and Street Name fields in combination with First Name and Last Name fields.

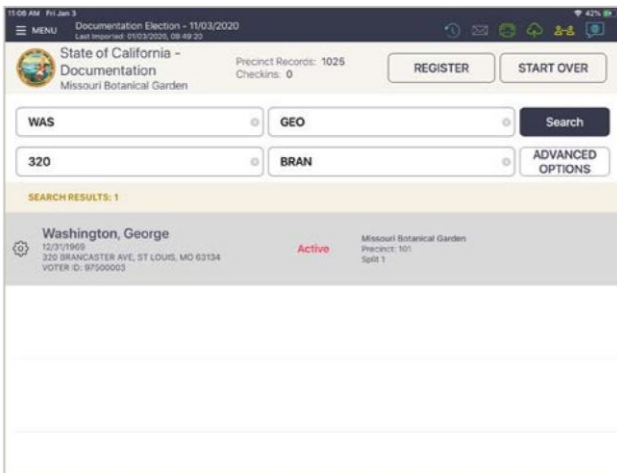

## 2) SELECT VOTER'S RECORD

Records matching the search criteria display onscreen.

Locate the voter's record and verify it does not contain any exceptions, then select the voter by touching their record.

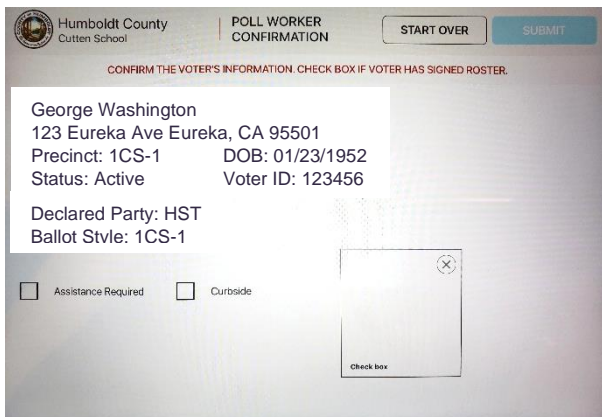

## 3) VOTER CONFIRMATION

The voter's information is displayed on-screen.

Verify the information is correct.

## PROCESSING VOTERS | VOTER SEARCH

Humboldt County  
Cutten School

POLL WORKER  
CONFIRMATION

START OVER SUBMIT

CONFIRM THE VOTER'S INFORMATION. CHECK BOX IF VOTER HAS SIGNED ROSTER.

George Washington  
123 Eureka Ave Eureka, CA 95501  
Precinct: 1CS-1 DOB: 01/23/1952  
Status: Active Voter ID: 123456

Declared Party: HST  
Ballot Style: 1CS-1

Assistance Required  Curbside

 Check box

### 4) SIGNATURE CONFIRMATION

Verify the voter signed the roster.

Check the box.

Press SUBMIT.



### 5) PROCESSED VOTER

Good job! You successfully processed the voter.

Direct the voter to the ballot handling table or Touch Writer.

# PROCESSING VOTERS | **ADVANCED SEARCH**

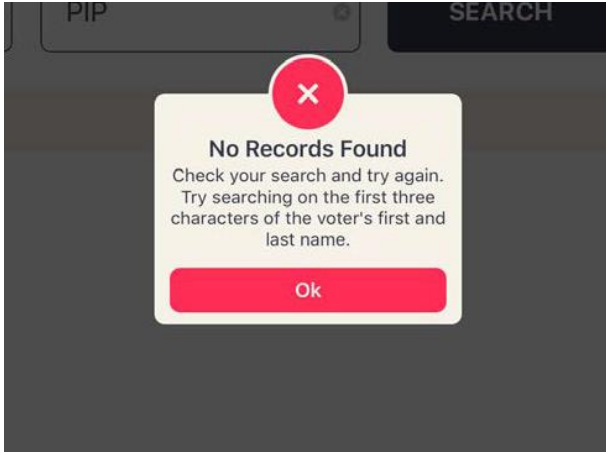

## 1) **VOTER NOT FOUND**

If the voter cannot be found, a pop-up displays:

No Records Found.

Press Ok to go back to VOTER LOOKUP.

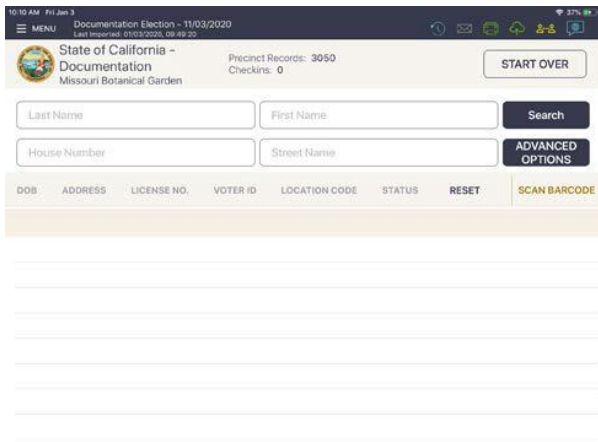

## 2) **ADVANCED SEARCH**

From the VOTER LOOKUP screen, press the **ADVANCED SEARCH** button.

**NOTE:** **ADVANCED SEARCH** options can be combined along with voter's name and address entry fields when searching for a voter's record.

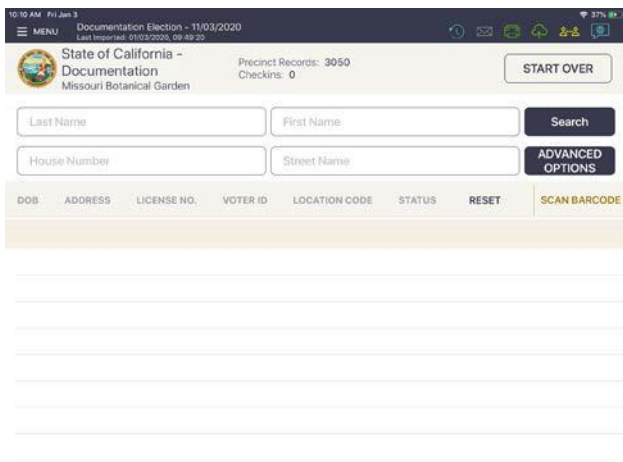

## 3) **SEARCH BY**

Look up the voter by using **DOB (DATE OF BIRTH)**, **ADDRESS**, **LICENSE NUMBER**, **LOCATION CODE**, or **STATUS**. Press **DONE** on the keyboard, then **Search**.

If voter is found using **ADVANCED SEARCH**, follow same protocol as scan barcode/manual entry to process voter.

# PROCESSING VOTERS | ADVANCED SEARCH

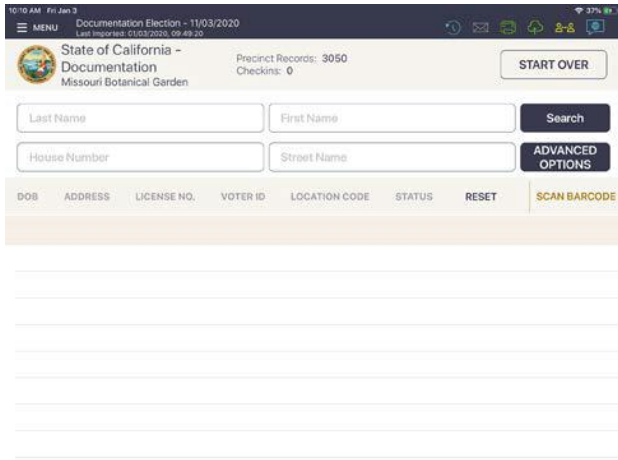

## 1) DOB ADVANCED SEARCH

Press the ADVANCED SEARCH button. The ADVANCED SEARCH option bar will display.

Press DOB.

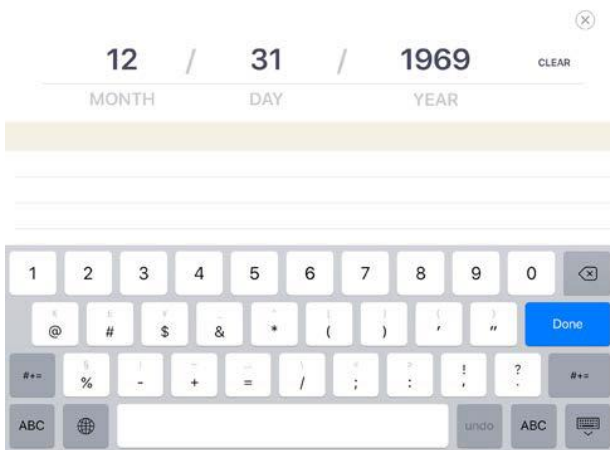

## 2) ENTER DATE OF BIRTH

Enter the voter's Date of Birth.

Press Done, then press Search.

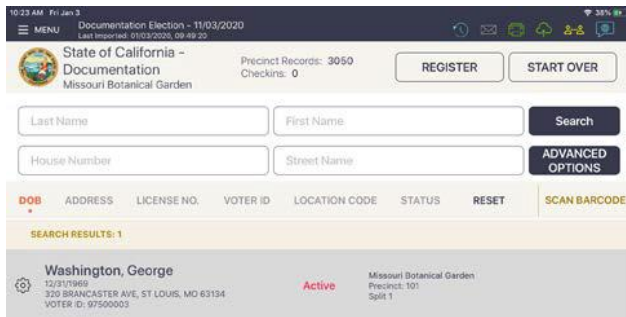

## 3) SELECT VOTER RECORD

Voter records matching the DOB will display. Select the correct voter's record to proceed.

# PROCESSING VOTERS | ADVANCED SEARCH

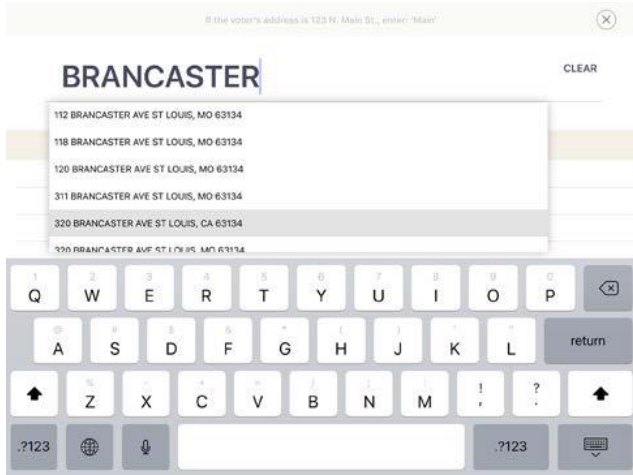

## 1) ADDRESS ADVANCED SEARCH

Press ADDRESS on the ADVANCED SEARCH option bar.

The STREET NAME\* field will display. Begin entering the voter's address street name. Matching entries will display in a list below.

Select the correct address.

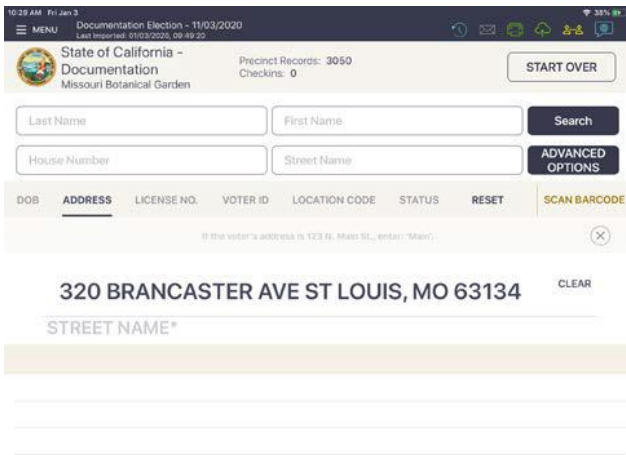

## 2) ENTER ADDRESS

The entire address will populate in the STREET NAME\* field.

Press Search.

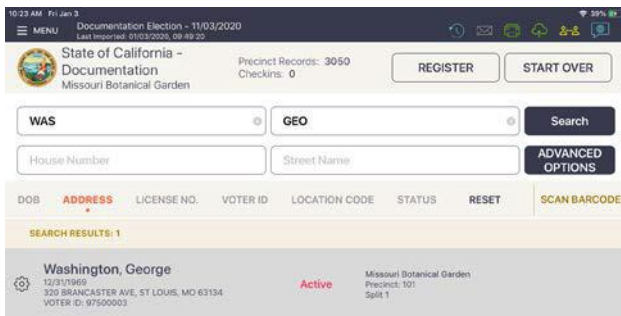

## 3) SELECT VOTER RECORD

The matching voter record will display. Press the voter's record to proceed.

# PROCESSING VOTERS | ADVANCED SEARCH



## 1) LOCATION CODE ADVANCED SEARCH

Press LOCATION CODE on the ADVANCED SEARCH option bar.

Enter the precinct in the GROUP field and the split in the SUBGROUP field.

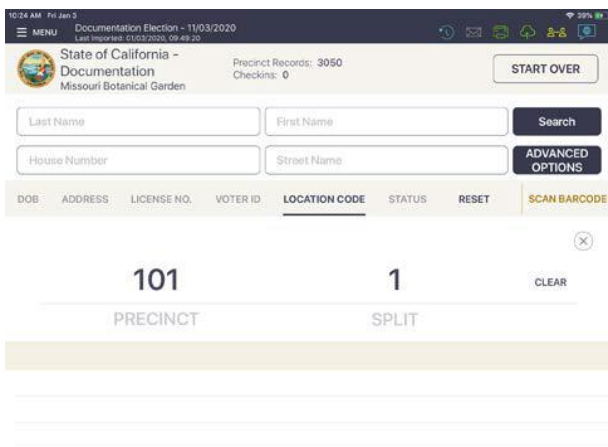

## 2) LOCATION CODE ADVANCED SEARCH

Press Search.

Voter records matching the criteria will display below.

Select the correct voter's record to proceed.

# PROCESSING VOTERS | ADVANCED SEARCH

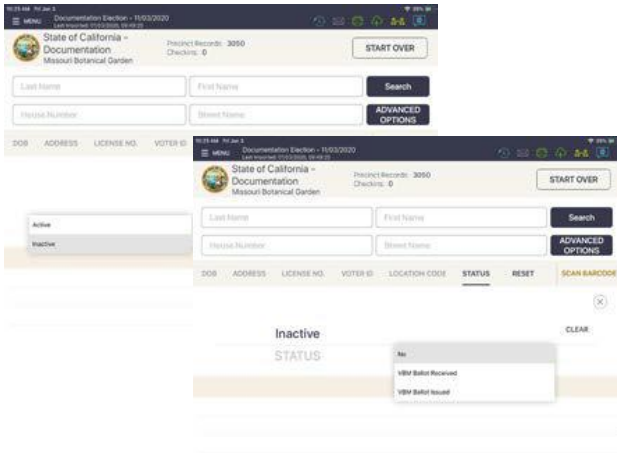

## 1) STATUS ADVANCED SEARCH

Press STATUS on the ADVANCED SEARCH option bar.

Select a STATUS and/or ABSENTEE STATUS.

Press Search.

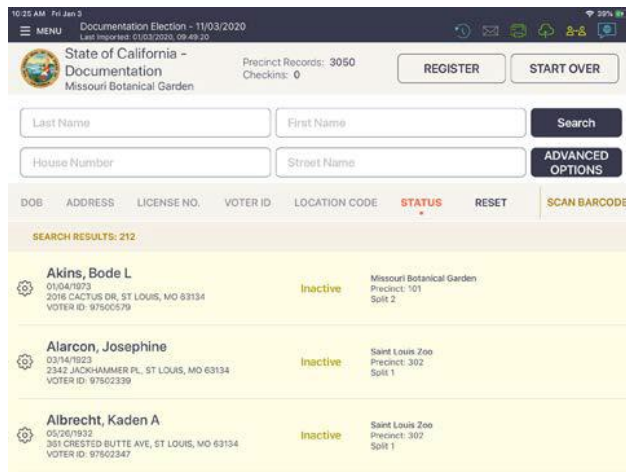

## 2) STATUS ADVANCED SEARCH

Voter records matching the criteria will display below.

Select the correct voter's record to proceed.

# PROCESSING VOTERS | PROVISIONAL PROCESS

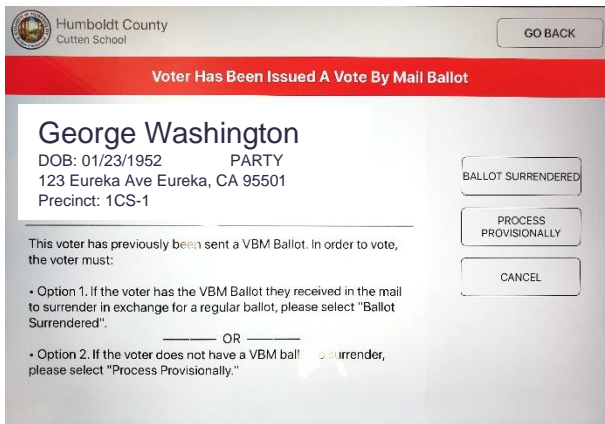

## 1) LOOK UP VOTER

Look up the voter's record. The election worker will confirm all information on the screen.

If the voter fails to meet requirements to be processed, they must vote a special ballot.

Press Process Provisionally.

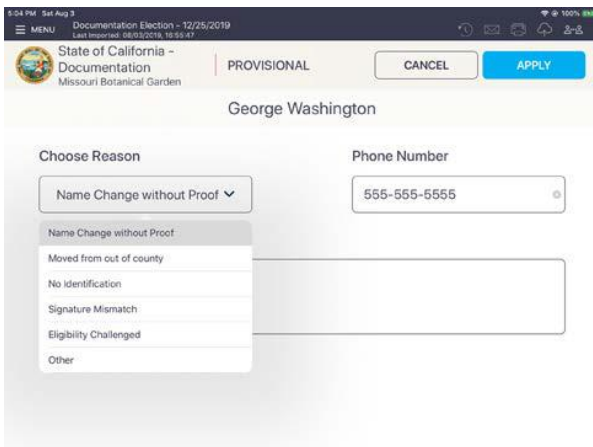

## 2) PROCESS AS PROVISIONAL

Select a reason from the drop-down.

When finished, press APPLY.

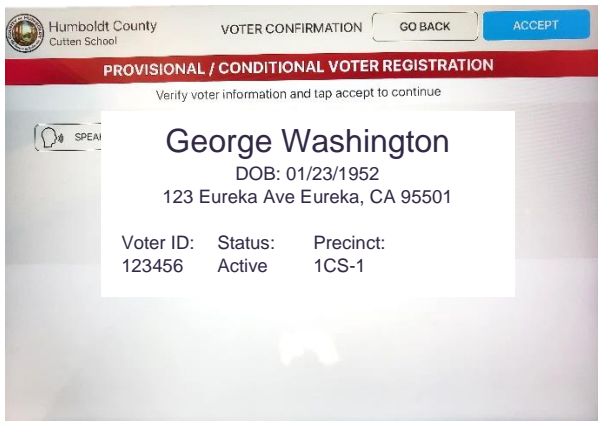

## 3) VOTER CONFIRMATION

A new screen will display with a PROVISIONAL red banner. The election worker will confirm all information on the screen.

Press ACCEPT to continue voter checkin.

## PROCESSING VOTERS | PROVISIONAL PROCESS

Humboldt County  
Curten School

POLL WORKER  
CONFIRMATION

START OVER SUBMIT

**PROVISIONAL / CONDITIONAL VOTER REGISTRATION**

CONFIRM THE VOTER'S INFORMATION. CHECK BOX IF VOTER HAS SIGNED ROSTER.

George Washington  
123 Eureka Ave Eureka, CA 95501  
Precinct: 1CS-1 DOB: 01/23/1952  
Status: Active Voter ID: 123456

Declared Party: HST  
Ballot Style: 1CS-1

Assistance Required  Curbside

Check box

### 4) SIGNATURE CONFIRMATION

Verify the voter signed the roster.

Check the box.

Press SUBMIT.



### 5) PROCESSED VOTER

Good job! You successfully processed the voter.

Direct the voter to the ballot handling table or Touch Writer.

# PROCESSING VOTERS | VOTE BY MAIL SENT

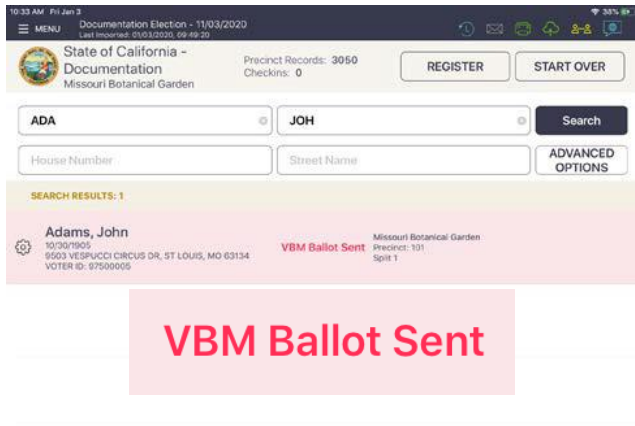

## 1) LOOK UP VOTER

Look up the voter's record. Records matching the search criteria display onscreen.

The voter's record contains a status that reads VBM Ballot Sent.

Press voter record.

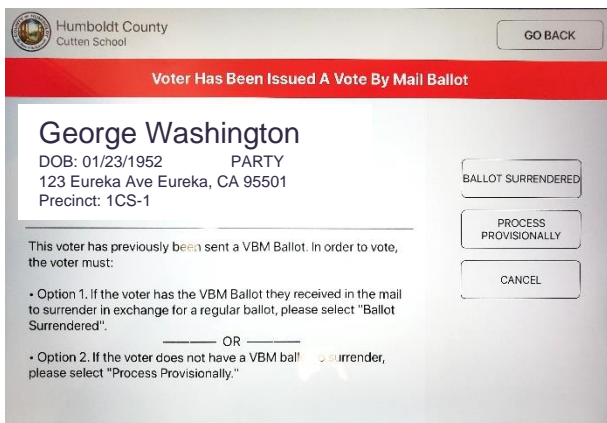

## 2) FOLLOW PROMPT

A prompt will display with instructions on how to process the voter. Select the appropriate button option to proceed.

# PROCESSING VOTERS | VOTE BY MAIL RECEIVED

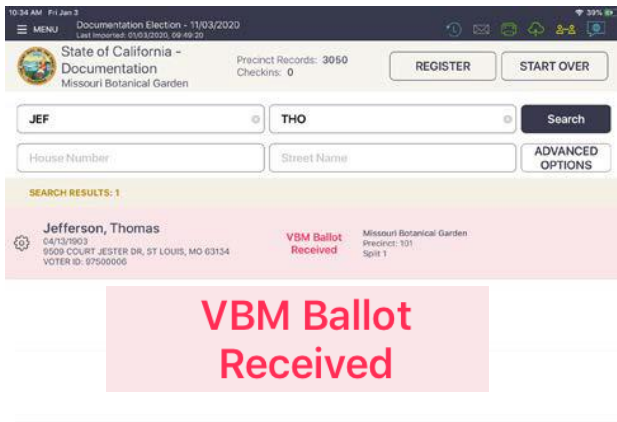

## 1) LOOK UP VOTER

Look up the voter's record. Records matching the search criteria display onscreen.

The voter's record contains a status that reads VBM Ballot Received.

Press voter record.

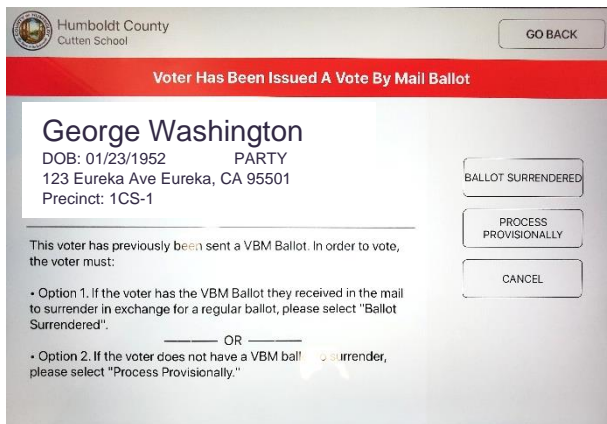

## 2) FOLLOW PROMPT

A prompt will display with instructions on how to process the voter. Select the appropriate button option to proceed.

# PROCESSING VOTERS | INACTIVE

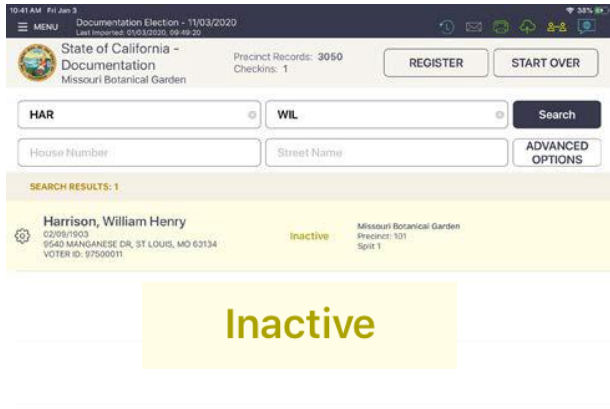

## 1) LOOK UP VOTER

Look up the voter's record. Records matching the search criteria display onscreen.

The voter's record contains a status that reads Inactive.

Press voter record.

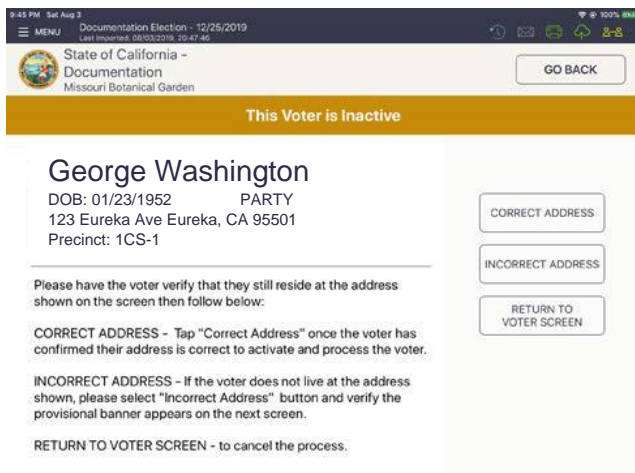

## 2) FOLLOW PROMPT

A prompt will display with instructions on how to process the voter. Select the appropriate button option to proceed.

# PROCESSING VOTERS | WRONG POLLING PLACE



Wrong Location

## 1) LOOK UP VOTER

Look up the voter's record. Records matching the search criteria display onscreen.

The voter's record contains a status that reads Wrong Location.

Press voter record.

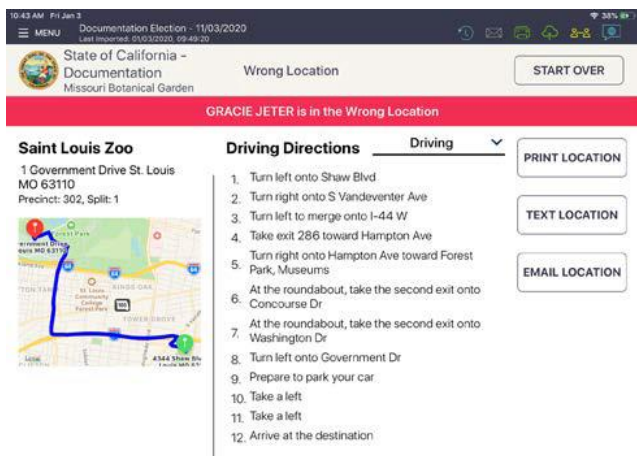

## 2) FOLLOW PROMPT

A prompt will display with the name and location of the voter's correct polling place.

If the voter wants to vote at their assigned polling place, print the polling place information.

If the voter wants to vote at this polling place, process them as a provisional voter.

# PROCESSING VOTERS | CURBSIDE VOTING

**DO NOT TAKE THE POLL PAD OUT OF THE VOTING AREA.**

**USE PAPER ROSTER FOR CURBSIDE VOTING.  
SEE PRECINCT BOARD HANDBOOK FOR CURBSIDE VOTING PROCEDURES.**

**POLL WORKERS WILL USE THE BELOW PROCEDURES TO UPDATE THE POLL PAD WITH CURBSIDE VOTER INFORMATION.**

The screenshot shows the 'Documentation Election - 11/03/2020' app interface. At the top, it displays 'State of California - Documentation Missouri Botanical Garden' and 'Precinct Records: 1025 Checks: 1'. There are 'REGISTER' and 'START OVER' buttons. Below, there are input fields for 'JET' and 'GRA', a 'Search' button, and fields for 'House Number' and 'Street Name' with an 'ADVANCED OPTIONS' button. The search results section shows one result for 'Jeter, Gracie' with details: '09/28/1933', '216 CONNER AVE, ST LOUIS, MO 63134', 'VOTER ID: 97502137', 'Active', 'Saint Louis Zoo Precinct: 332 Split: 1', and a red 'Wrong Location' warning.

## 1) LOOK UP VOTER

Look up the voter's record. Records matching the search criteria display onscreen.

Press voter record.

The screenshot shows the 'Documentation Election - 12/25/2019' app interface. It displays 'State of California - Documentation Missouri Botanical Garden' and 'POLL WORKER CONFIRMATION' with 'START OVER' and 'SUBMIT' buttons. A red instruction reads 'CONFIRM THE VOTER'S INFORMATION'. The voter details for 'George Washington' are shown: '9769 CHELLS DR, ST LOUIS, MO 63134', 'Precinct: 101 DOB: 12/31/1969', 'Split: 1 Voter ID: 97500003', and 'Status: Active'. There is a signature field with a handwritten signature and a 'Signature on Election Day' label. Below, there are checkboxes for 'Assistance Required' (unchecked) and 'Curbside' (checked). A large 'Curbside' button with a checkmark is also present. To the right, there is a box for 'Initial' with an 'X' icon.

## 2) CURBSIDE VOTING

If a voter must vote curbside, a Curbside checkbox is found on the ELECTION WORKER CONFIRMATION screen.

Press the Curbside checkbox. Continue voter checkin.

# PROCESSING VOTERS | ASSISTANCE REQUIRED



## 1) LOOK UP VOTER

Look up the voter's record. Records matching the search criteria display onscreen.

Press voter record.

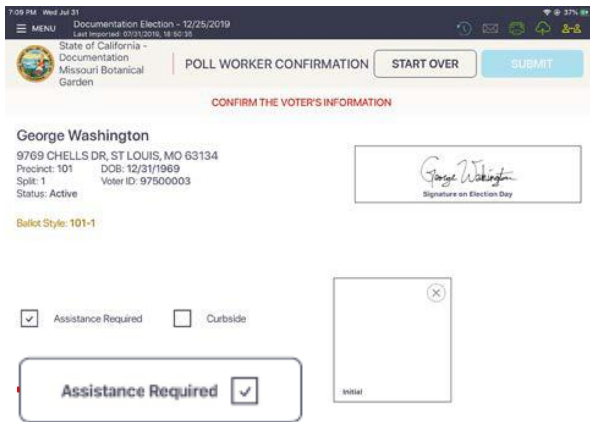

## 2) VOTER ASSISTANCE

If a voter requires assistance, an Assistance Required checkbox is found on the ELECTION WORKER CONFIRMATION screen.

Press the Assistance Required checkbox.

# CLOSING PROCEDURES



### 1 POWER OFF & UNPLUG PRINTER

Power off the printer and unplug from outlet. Disconnect printer cable from adapter box and printer.

**NOTE:** Keep Poll Pad powered on.



### 2 FOLD STAND ARM

After disconnecting hardware from the Poll Pad, place components back in carrying case. Once the stand arm has been removed from the Poll Pad and stand base, fold the stand arm backwards to fit in the case.

**NOTE:** Keep Poll Pad powered on.

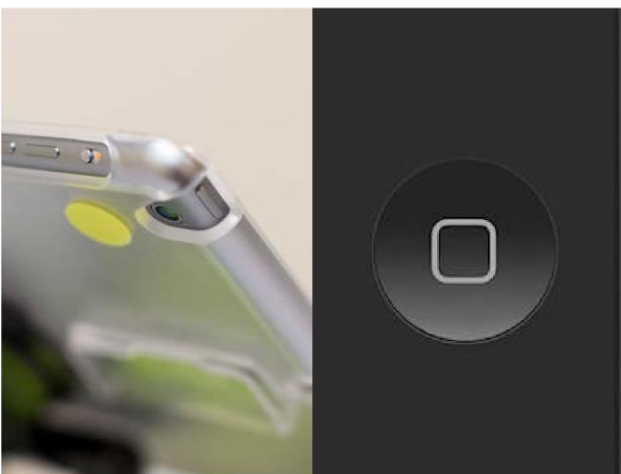

### 3 POWER OFF POLL PAD

Turn off Poll Pad by holding the power button and the home button (pictured) simultaneously until the screen goes black. Place Poll Pad in the carrying case.



## 4 PACK POLL PAD CASE

Disassemble the Poll Pad and return the supplies to the Poll Pad case. Close the lid and secure.

- 1 Green Case
- 2 Poll Pad
- 3 Poll Pad Base
- 4 Stand Arm
- 5 Power Cube and Cord
- 6 (2) Stylus
- 7 Photo ID Tray
- 8 Poll Pad Screen Cloth
- 9 Printer and Cords



## 5 RETURN SUPPLIES

Return Poll Pad case to the election's office on election night, along with other precinct supplies.

**NOTE:** To ensure accuracy, remember to place the Poll Pad supplies in the appropriate case/tote.

# TROUBLESHOOTING

# TROUBLESHOOTING

## CHARGING POLL PAD

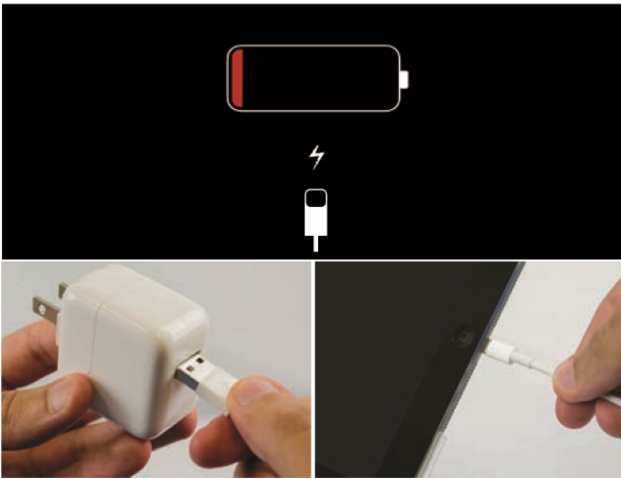

- 1 Plug USB end of power cable into power cube.
- 2 Plug power cube into an AC wall outlet.
- 3 Plug power cable into lightning connector on Poll Pad.
- 4 Wait about five minutes for the Poll Pad to charge.
- 5 With sufficient power, Poll Pad will auto power on.
- 6 Resume normal operations.

**NOTE:** To confirm your unit is charging, verify battery icon is green and lightning bolt is displayed. 57%

## POLL PAD CHARGING ICON

If the battery indicator is not green or a charge icon does not appear, verify the following:

- 1 Power cable is connected to the Poll Pad.
- 2 Power cube is plugged into the surge protector.
- 3 Surge protector is plugged into a wall outlet.
- 4 Power switch on the surge protector is set to the on position.

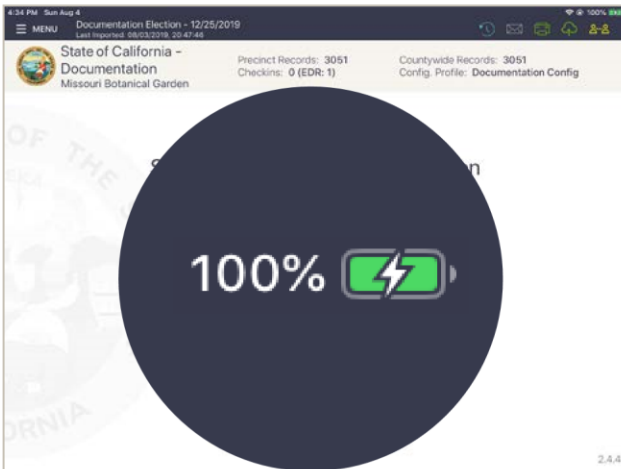

## iOS SOFTWARE UPDATE

**DO NOT** perform a software update on the Poll Pad. In the unlikely event that an iOS update prompt displays on the device, perform the following steps:

- 1 From the list of on-screen options, select **Later**.
- 2 Press the Home button and verify Poll Pad app remains open.

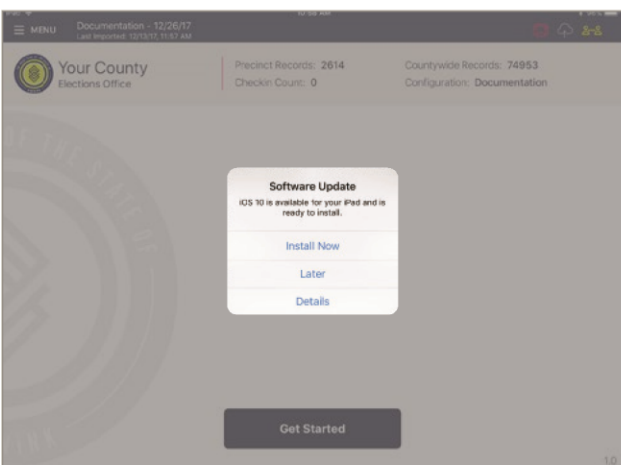

# TROUBLESHOOTING

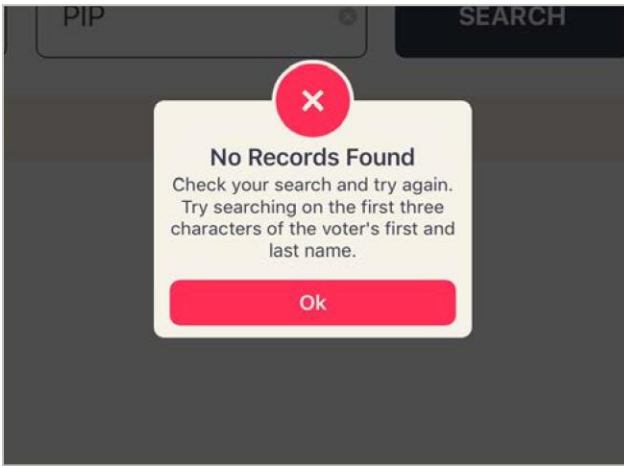

## VOTER NOT FOUND

- 1 Record does not match the Registration record (example: Bill/William).
- 2 Check that names are typed correctly. Use fewer letters of the Voter's name, or search by First or Last name only.

**Still having trouble?** Refer voter to the Specialist within the polling place or call the Election office.

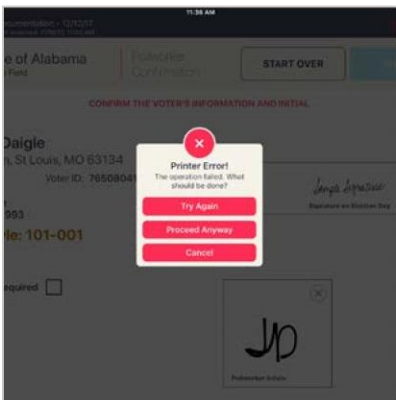

## NOT PRINTING / STOPS PRINTING

- 1 Make sure the printer is turned on.
- 2 Confirm the printer is plugged into outlet and cords are securely connected.
- 3 Verify paper is installed correctly.
- 4 Confirm connection with Poll Pad (green icon).



## CHANGING PAPER

- 1 Open printer.
- 2 Reload paper with the paper flap toward you, feeding from the bottom/underneath roll.
- 3 Close and **Print Test Receipt**.

# TROUBLESHOOTING

## LOST PRINTER CONNECTION



Printer icon will turn red if printer has lost connection to Poll Pad. Press the printer icon, a status box will display, **Printer Status: Not Connected**.

❶ Close and reopen Poll Pad app, by double clicking the Home button and swiping the app up or by navigating to **Exit Application** on the **MENU** screen.

## PRINTER BLUETOOTH CONNECTION



If previous troubleshooting steps do not reestablish printer connection, check Bluetooth settings.

❶ Navigate to the Home screen and select the **Settings** app.

**Note:** If Poll Pad is in guided access mode you will need to end guided access mode in order to access home screen.

## PRINTER BLUETOOTH CONNECTION

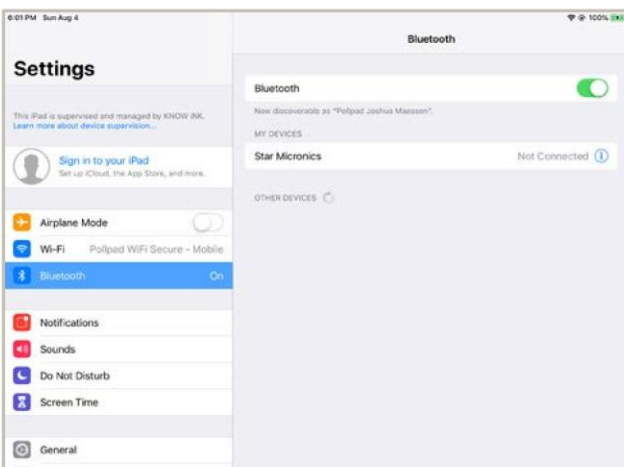

❷ Select **Bluetooth** from the left, verify Bluetooth toggle switch is on. Turn on if toggle switch is off.

❸ Check the status of the **Star Micronics** printer. If Not Connected, press on **Star Micronics** to attempt reestablishing bluetooth connection to printer.

## TROUBLESHOOTING



### PRINTER BLUETOOTH CONNECTION

4 On the back of the printer, PRESS and HOLD the **"Pair"** button for approximately **six (6)** seconds. The green LED will flash. Release the Pair button; the LED will continue to flash green, then change to flashing blue.

5 From the **Bluetooth** settings, select the **Star Micronics** printer. The light will change to solid blue when connection is successful.

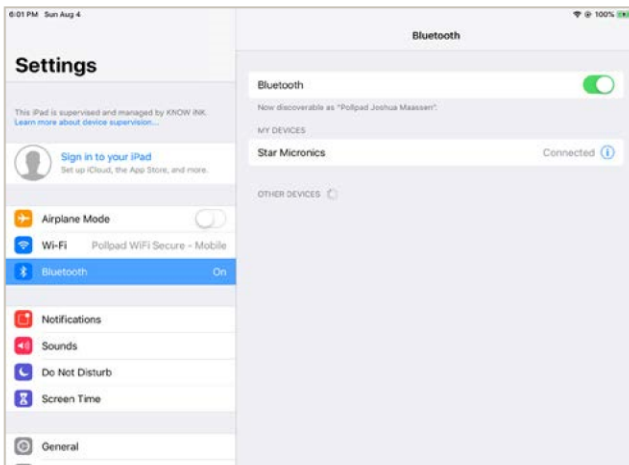

### PRINTER BLUETOOTH CONNECTION

6 In the **Bluetooth** settings the **Star Micronics** printer will now display **Connected**.

7 Open the Poll Pad app and verify printer icon is green. Complete a **Test Print** to ensure printer is working.

# ADVANCED FUNCTIONS

# POLL PAD | SUMMARY REPORT



## 1 LOCATE SUMMARY REPORT

To access **Summary Report** on Poll Pad, press **MENU** then **Summary Report**.

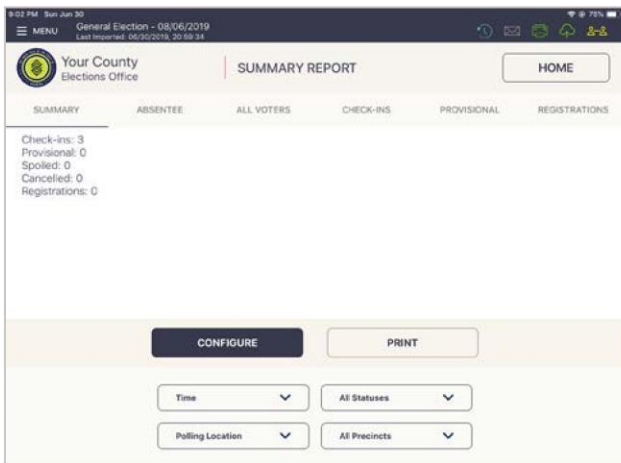

## 2 SUMMARY REPORT

**SUMMARY REPORT** data can be filtered by type using the headers across the top of the screen. Headers:

- SUMMARY
- ABSENTEE
- ALL VOTERS
- CHECK-INS
- PROVISIONAL
- REGISTRATIONS

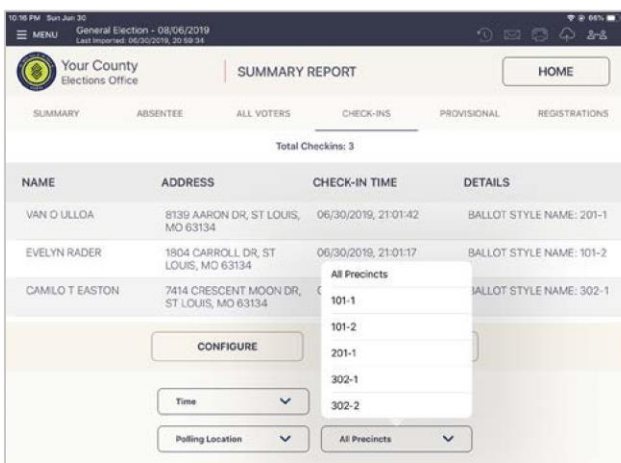

## 3 CONFIGURE SUMMARY REPORT

Use the **CONFIGURE** button at the bottom of the screen to sort and print the desired information.

# **LEAD JUDGE SCENARIOS**

## LEAD JUDGE SCENARIOS | CANCEL VOTER CHECK-IN

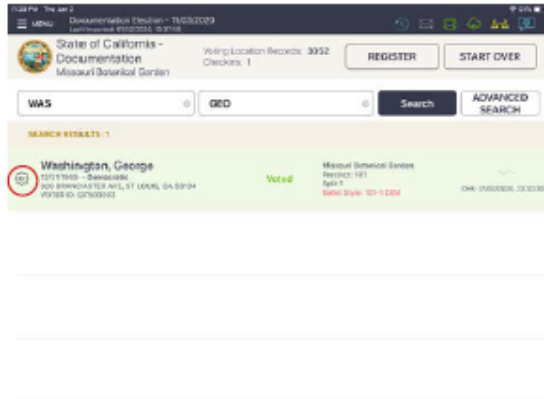

### 1 LOOK UP VOTER

Look up the voter checkin record that need to be canceled by **MANUAL ENTRY** instructions.

Press the **Settings** icon next to the voter's name.

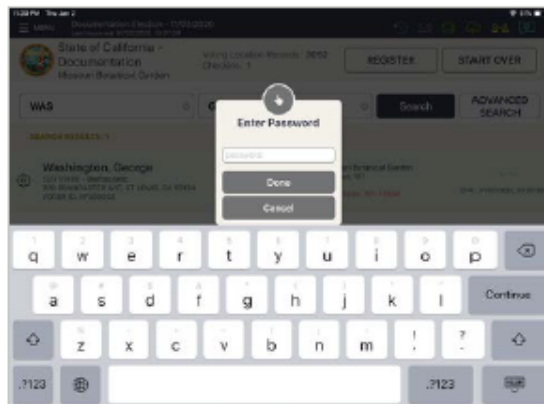

### 2 ENTER PASSWORD

Enter the **Extra Functions Password** (password will be provided by the election authority).

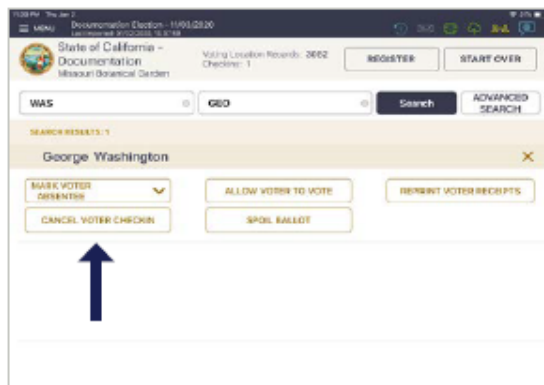

### 3 CANCEL THE CHECK-IN

The **Extra Functions** menu will display in place of voter's record.

Press **CANCEL VOTER CHECKIN**.

## LEAD JUDGE SCENARIOS | CANCEL VOTER CHECK-IN

Cancel Voter Check-In

JANE JUDGE

Type Details

SELECT REASON

- Voted Previously
- Voter Left without voting
- Voter Selected Wrong Party
- Wrong Voter Processed
- Other

### 4 ELECTION WORKER NAME & REASON

The Election Judge Authority canceling the voter check-in should enter their name. From the drop-down menu, select the reason for canceling the check-in. If you choose **Other** for reason, you must type details in the box provided to proceed.

Press **NEXT**.

Cancel Voter Check-In

Voter Information: Jane, James - 03/18/2001  
9408 Court Jester Dr  
St Louis, MO 63134

Cancellation Reason: Wrong Voter Processed

Jane Judge

CLEAR SIGNATURE

### 5 REVIEW, SIGN & SUBMIT

Election Judge must sign using their **FULL NAME** then press **SUBMIT**.

Documentation Election - 11/03/2020

State of California - Documentation

Missouri Botanical Garden

Missung Location Records: 3032

Check-ins: 0

START OVER

WAS GEO Search ADVANCED SEARCH

SEARCH RESULTS: 1

Washington, George

10/01/2020 - Benavente

125-26 ANCHUTER AVE, ST LOUIS, CA 93114

Voter ID: 81100003

Action

MISSOURI BOTANICAL GARDEN

RECTOR 101

Site 1

### 6 CHECK-IN CANCELED

Voter will be removed from check-in count.

**Voted** status will be removed.

# LEAD JUDGE SCENARIOS | REPRINT RECEIPTS

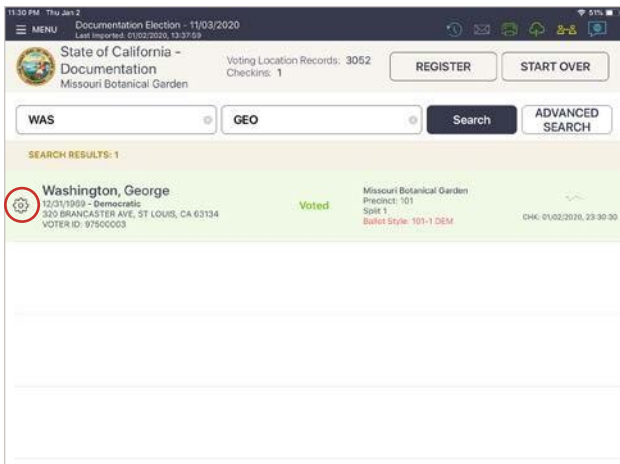

## 1 LOOK UP VOTER

Lookup the voter's record using **MANUAL ENTRY** instructions.

Press the **Settings** icon next to the voter's name and enter the password.

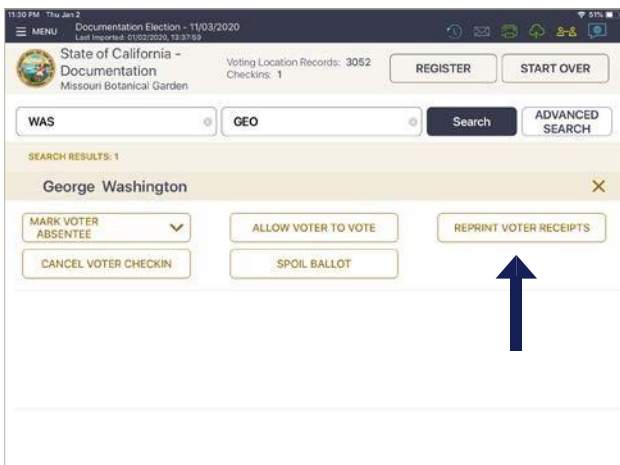

## 2 REPRINT VOTER RECEIPT

The **Extra Functions** menu will display in place of voter's record.

Select **REPRINT VOTER RECEIPTS**

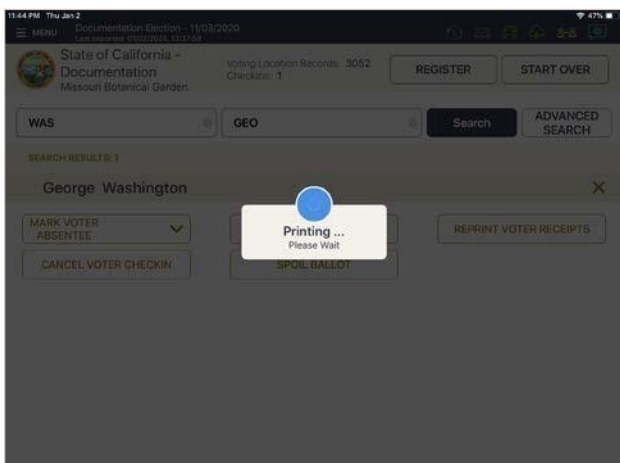

## 3 CONFIRM

A pop-up will display **"Printing... Please Wait"**.

A duplicate receipt will automatically print.

**NOTE:** Printed receipt will be marked **"DUPLICATE"**.

