



Book 1

Humboldt County Sheriff's Office Supplemental Report

Case #: 200703162

Date: 12/18/07

Location of occurrence: Bloody Camp Rd. at Hostler Ranch-Hoopa, Ca.

Charge(s): 664/187(a) p.c., attempted murder; Officer Involved Shooting

[REDACTED]

Description: IMA 5'-11" 160 Brn Brn

[REDACTED]

[REDACTED] Hoopa Valley Police Department Sergeant Ed K. Guyer #2503
Address: Hoopa Valley Police Department, SR 96-Hoopa, Ca.

[REDACTED] Hoopa Valley Police Department Officer [REDACTED] F. Spallino #2504
Address: Hoopa Valley Police Department, SR 96-Hoopa, Ca.

[REDACTED] California Highway Patrol Officer Mike W. Nolan #11310
Address: California Highway Patrol-255 West Samoa Blvd. Arcata, Ca.

[REDACTED] Humboldt County Sheriff's Office Deputy Greg A. Berry #1055
Address: 826 4th St.-Eureka, Ca.

[REDACTED] Yurok Tribal Police Officer Heather M. Landreneaux #1554
Address: 247 Salmon Ave.-Klamath, Ca.

[REDACTED]

██████████ Humboldt County Sheriff's Office Deputy Jason S. Daniel #1191
Address: 826 4th St.-Eureka, Ca.
██████████

██████████ Eureka Police Department Sergeant Bill Nova #L-64
Address: 604 C St.-Eureka, Ca.
██████████

██████████ Eureka Police Department Officer Tim Jones #3B67
Address: 604 C St.-Eureka, Ca.
██████████

██████████ Eureka Police Department Officer Louis Altic #3B89
Address: 604 C St.-Eureka, Ca.
██████████

██████████ Humboldt County Sheriff's Officer Sergeant Bryan J. Quenell #0872
Address: 826 4th St.-Eureka, Ca.
██████████

██████████ Humboldt County Sheriff's Office Deputy Brian M. Taylor #1377
Address: 826 4th St.-Eureka, Ca.
██████████

██████████ 1
██████████ Humboldt County Sheriff's Office Sergeant Mike A. Fridley #0837
Address: 826 4th St.-Eureka, Ca.
██████████

Narrative: On 6/3/07 at about 1620 hrs, I spoke to Lieutenant George Cavinta via telephone at my residence. Lieutenant Cavinta advised me that Deputies had responded to a residence in the area of Pine Creek Rd. and Bald Hills Rd. in Hoopa, Ca. When the Deputies arrived at the residence, they met with a male ██████████ who brandished a firearm at them. The male was now barricaded in the residence and other Deputies and Hoopa Valley Tribal Police Officers were on scene and had set up a perimeter around the residence. Lieutenant Cavinta advised me that the Sheriff's Office SET (Special Enforcement Team) team had been called out and were to respond to the residence.

Lieutenant Cavinta advised me to respond to the scene. At about 1639 hrs, I left my residence en route to the Pine Creek Rd. and Bald Hills Rd. area. I transported Tactical Dispatcher ██████████ with me who had also been called out by Lieutenant Cavinta.

At about 1824 hrs, Dispatcher ██████████ and I arrived on scene. The road that we had actually been directed to was known as Bloody Camp Rd. and the residence that the male ██████████ had barricaded himself in was off Bloody Camp Rd. on the Hostler Ranch.

At about 1825 hrs, I was standing near my vehicle when I heard two to three gunshots and I then heard radio traffic that shots had been fired. I heard further radio traffic that the ██████████ had shot at patrol units and a Deputy had returned fire. After this had occurred several Sheriff's Office patrol units that had just arrived on scene drove down a gravel driveway that was identified as the driveway that led to the residence where the barricaded ██████████ was.

I noticed Deputy Darrell Mabry standing at the intersection of Bloody Camp Rd. and the driveway to the residence. Deputy Mabry was speaking to several people who were later identified as the parents to the male that had barricaded himself in the residence. In the area where Deputy Mabry was standing, I noticed two white wooden poles on each side of the driveway. On the pole to the north or to the right of the driveway, there was an "H" on this pole. Dispatcher [REDACTED] then advised me that the barricaded male's name was [REDACTED]

At about 1839 hrs, I telephoned Sergeant Wayne Hanson at his residence via my cellular phone. I advised Sergeant Hanson that a search warrant was going to be needed eventually for the residence [REDACTED] had barricaded himself in. Sergeant Hanson advised me to contact him at his residence when I thought a search warrant should start being prepared.

I next met with Lieutenant Cavinta who was standing at his vehicle about 100 yards down the gravel driveway. We discussed that we would need to get the CIRT (Critical Incident Response Team) team involved because we now had an Officer involved shooting. Lieutenant Cavinta advised me that he would telephone the District Attorney's Office Chief Investigator Mike Hislop and have Investigator Hislop make the notifications for CIRT team personnel to respond to assist in the investigation.

I returned to the intersection of the gravel driveway and Bloody Camp Rd. and met with Deputy Mabry. Deputy Mabry pointed out to me [REDACTED] father, [REDACTED] and [REDACTED] mother [REDACTED] who were on scene. I met with [REDACTED] and asked him if I could speak to him at my vehicle, which he agreed to do.

On 6/3/07 at about 1845 hrs, I interviewed [REDACTED] outside of my vehicle. The interview was digitally recorded and later placed onto CD. The following is a brief summary of the interview conducted with [REDACTED] Refer to the CD or transcript for further details.

I asked [REDACTED] how he heard what was occurring with his son [REDACTED] [REDACTED] said that he stopped by Ray's Food Place in Hoopa and met with his other son, [REDACTED] and [REDACTED] advised [REDACTED] that [REDACTED] was at [REDACTED] and [REDACTED] had pulled a gun on Officers.

I asked [REDACTED] if he knew anything about [REDACTED] [REDACTED] said that he heard about this but that was all he knew. [REDACTED] said that he and [REDACTED] mother, [REDACTED] were not close and [REDACTED] did not communicate with [REDACTED] about their four sons. [REDACTED] added that he and [REDACTED] had been divorced since 1996. Since that time, [REDACTED] had tried to turn their sons against him.

I asked [REDACTED] when the last time that he had spoken with [REDACTED] was. [REDACTED] believed it was about one week ago and [REDACTED] was with [REDACTED] who [REDACTED] believed was not a very good "character". [REDACTED] were at the 76 gas station in Hoopa and

██████ was carrying a lunch pail with him. ██████ asked ██████ what was up and ██████ told ██████ that he was just getting some lunch and ██████ replied by holding up the lunch pail and said, "Tuna."

██████ told me that ██████ looked "scraggly" and had lost a lot of weight.

I asked ██████ about ██████ ██████ told me that he believed that ██████ ██████ said that he had never seen ██████ but ██████ had used ██████ in the past and knows the effects of it. ██████ stated that he was unsure if it was the ██████ affecting ██████ or ██████ was not taking his ██████

I asked ██████ if he knew what ██████ had been ██████ with as far as ██████ ██████ believed ██████ was ██████ ██████ added that he felt ██████ was in the situation he was now in because ██████ realized that he needed help and ██████

██████ told me from what he knew ██████ had gotten into a fight with ██████ earlier in the day and ██████ ended up at the ██████ Ranch.

██████ was unsure of why ██████ came to the residence he was currently barricaded in. ██████ said that ██████ at one time resided in the Bloody Camp Rd. area. ██████ said that he had never himself been at the residence ██████ was currently at. ██████ said that ██████ and ██████ were the people that actually lived at the residence. I asked ██████ if he had any idea, why ██████ would have come to ██████ and ██████ residence. ██████ said that he did not know why.

I asked ██████ if ██████ got violent when he gets into a state of mind, such as he was now. ██████ said that ██████ had never been violent toward him but ██████ believed ██████ had been violent toward ██████.

██████ told me recently that he had seen a decline in ██████ ██████ physical health. ██████ added that when ██████ was ██████ ██████ was pretty much a normal person. This concluded my interview with ██████

After speaking to ██████ I noticed about 150 yards to the south of the intersection of Bloody Camp Rd. and the driveway there was a large two-story residence. I had no idea how far away the residence was that ██████ had barricaded himself in. I went to this residence to see if the occupants would be willing to leave their residence to keep out of harms way. I went to the residence and knocked on several doors and windows; there was no response so I returned to Bloody Camp Rd.

On 6/3/07 at about 1911 hrs, I met with ██████ ██████ at my vehicle. ██████ was ██████ mother. I conducted an interview with ██████ which was digitally recorded and later placed onto CD. The following is a brief summary of the interview. Refer to the CD or transcript for further details.

I explained to [REDACTED] that I did not have all of the details about what had occurred with [REDACTED] and asked [REDACTED] to explain to me how this all began. [REDACTED] told me that it began about two months ago when [REDACTED]

[REDACTED] told me that she was also the payee [REDACTED]. [REDACTED] began coming to [REDACTED] and wanting his money. [REDACTED]

[REDACTED] said just recently that she had been contacting Hoopa Valley Tribal Police Chief Willie Hostler in regards to [REDACTED]. Chief Hostler advised [REDACTED] that certain criteria needed to be met for [REDACTED] to be transported to [REDACTED]. [REDACTED] said that she understood this but continued to call Chief Hostler in an attempt to have [REDACTED].

[REDACTED] said that [REDACTED] was eventually taken to [REDACTED]. On 5/25/07 at about 2200 hrs, [REDACTED] showed up at [REDACTED] residence and was loud but not too obnoxious. [REDACTED] said she met with [REDACTED] and told [REDACTED] that he needed to be quiet because there was a baby sleeping in the residence. [REDACTED] told [REDACTED] that he could fix something to eat and stay the night.

On 5/26/07 at about 0400 hrs, [REDACTED] said that [REDACTED] went "berserk" and started telling [REDACTED] that all he wanted was some sleep. [REDACTED] became very loud and obnoxious and [REDACTED] felt that [REDACTED] met the criteria for [REDACTED]. [REDACTED] called for the Tribal Police Department and Tribal Police Sergeant Ed Guyer responded with ambulance personnel. [REDACTED] said that [REDACTED] met with Sergeant Guyer and [REDACTED] asked Sergeant Guyer to take him away. [REDACTED]

[REDACTED] told me that while [REDACTED] was at [REDACTED] he damaged some items [REDACTED]. Eureka Police Department Sergeant Armstrong took a report regarding the vandalism that [REDACTED] had done. [REDACTED] said that she had spoken to Sergeant Armstrong and he advised her that he had taken [REDACTED] to the Humboldt County Correctional Facility. [REDACTED] told me that [REDACTED] was in the Correctional Facility from 5/26/07 to 5/29/07. [REDACTED] told me that she made several phone calls to try to get [REDACTED]. [REDACTED] said on 5/29/07, [REDACTED]

[REDACTED] said from what she understood [REDACTED] was released from [REDACTED] on 6/1/07. [REDACTED] told me on 6/2/07, in the evening hrs, she went to [REDACTED] residence, which was located on Masten Flat in Hoopa. [REDACTED] had moved a trailer to Masten Flat because this was where [REDACTED] wanted to live. [REDACTED] said when she met with [REDACTED]

██████████ told me that her other son, ██████████ also came to ██████████ residence. ██████████ said that she and ██████████ told ██████████ that he needed to get dressed and that they were going to take him to one of their residences. ██████████ said that ██████████ began putting on a large amount of clothing ██████████ ██████████ tried to tell ██████████ to take some of the clothing off but ██████████ was worried that someone was going to steal the clothing.

██████████ said that she drove ██████████ to ██████████ residence and asked ██████████ if he could watch over ██████████ for the night. ██████████ agreed to do this.

██████████ said on 6/3/07 at about 1000 hrs, ██████████ brought ██████████ to ██████████ residence. ██████████ told ██████████ that ██████████ was at his house cutting up ██████████ clothing and some of his other belongings. ██████████ told ██████████ that he was unable to care for ██████████ due to his current condition.

██████████ said that at first ██████████ was telling her that he loved her and the next moment ██████████ became angry and was asking ██████████ for his money. ██████████ told ██████████ that he could not be around ██████████ three-year-old granddaughter because of the way he was acting. ██████████ took her granddaughter into another room and again met with ██████████. ██████████ said when she met with ██████████ he was going to try and spit on her and ██████████ intervened and took ██████████ away from ██████████ residence.

██████████ said that ██████████ dropped ██████████ off at an unknown location. ██████████ said that she telephoned the Tribal Police Department and advised the person that she was talking to that ██████████ ██████████

██████████ said shortly after the telephone call Officer Mike Roberts arrived at her residence. Officer Roberts attempted to locate ██████████ but was unsuccessful.

██████████ said on 6/3/07 at about 1200 hrs, she received a telephone call at her residence from ██████████. ██████████ told ██████████ that ██████████ had come to her house and ██████████ was trying to get ██████████ to take off some of his clothing because it had appeared to her that ██████████ had walked to her house. ██████████ added that she used to live in the Bloody Camp Rd. area and ██████████ used to haul hay for ██████████ who lived near ██████████ and ██████████. ██████████ believed that ██████████ went to ██████████ house because he felt it was a safe place.

██████████ went on to tell ██████████ that ██████████ was telling her that he just wanted to sleep and that ██████████ was not acting himself. ██████████ said that she again telephoned the Tribal Police Department and spoke to a dispatcher. ██████████ advised the dispatcher that ██████████ needed to be taken to ██████████ and to have an ambulance respond to ██████████ residence.

I advised Sergeant Guyer that I would need to interview him along with the other Officers involved and Sergeant Guyer told me he would relay the message to the other Officers.

After meeting with Sergeant Guyer, I met with Lieutenant Cavinta to confirm that the CIRT team was en route because there were multiple persons that needed to be interviewed. Lieutenant Cavinta advised me that he had made the notifications.

On 6/3/07 at about 2013 hrs, I walked up to the second Tribal Police patrol unit that had been shot at by [REDACTED]. At this patrol unit, Sergeant Mike Fridley and Deputy Jason Daniels were attempting negotiations with [REDACTED] by utilizing the unit's public address system. I went to this location to obtain a description of the residence [REDACTED] had barricaded himself in. From this location, I could only see the south side of the residence. I could see that there were two windows on the side of the residence and the residence appeared to be a wooden type of structure but I had also received information that it was a trailer with a wooden add on. I could see that this residence had a black colored roof and the house and/or trailer was painted green with brown trim.

I walked back to the intersection of the driveway and Bloody Camp Rd. and met with a male [REDACTED] who was standing in the area. The male identified himself as [REDACTED] [REDACTED] brother. I asked [REDACTED] if I could speak to him in my vehicle and he agreed to do so. I interviewed [REDACTED] at my vehicle and the interview was digitally recorded and later placed onto CD. The following is a brief summary of the interview I conducted with [REDACTED]. Refer to the CD or transcript for further details.

I explained to [REDACTED] that I was speaking to him to try to find out why [REDACTED] was in the situation he was currently in. I told [REDACTED] that I had recently spoke to his mother and she advised me that he had recently seen [REDACTED]. [REDACTED] told me that he last saw [REDACTED] on 6/3/07 between the hrs of 1000 and 1100.

[REDACTED] said he was at his mother, [REDACTED] residence where [REDACTED] also resided. [REDACTED] said that he was sleeping in his bedroom when [REDACTED] came into the room and woke [REDACTED] up. [REDACTED] asked [REDACTED] what had been going on and [REDACTED] told [REDACTED] that he was looking for his guitar. [REDACTED] told [REDACTED] that his guitar was in [REDACTED] closet where he had left it. [REDACTED] told [REDACTED] that he had cleaned his closet so the guitar was now on the other side of the closet. [REDACTED] told [REDACTED] that was okay because he wanted [REDACTED] to give the guitar to [REDACTED] daughter. [REDACTED] told me that he was going to tell [REDACTED] to take the guitar because it belonged to him but [REDACTED] did not tell [REDACTED] this. [REDACTED] left [REDACTED] room and [REDACTED] said he fell back to sleep and woke up around noon.

I asked [REDACTED] how [REDACTED] was acting when he spoke to him. [REDACTED] said that [REDACTED] seemed fine to him but they only spoke a short time.

I asked [REDACTED] if he heard [REDACTED] and [REDACTED] arguing. [REDACTED] told me he did not because he was sleeping. [REDACTED] added that [REDACTED] frequently yelled at [REDACTED] who was [REDACTED] payee, because [REDACTED] wanted his money from her so he can go party.

I asked [REDACTED] if he was aware of [REDACTED] and [REDACTED] said he was and was aware of [REDACTED] [REDACTED] believed that [REDACTED]

I asked [REDACTED] what he thought about the situation with [REDACTED] being armed with a gun. [REDACTED] told me that the situation just escalated because of the [REDACTED] [REDACTED] was in.

I asked [REDACTED] if [REDACTED] was ever suicidal and [REDACTED] told me that [REDACTED] used to be suicidal. [REDACTED] now just did whatever he wanted to do.

I asked [REDACTED] why [REDACTED] would have come to [REDACTED] and [REDACTED] residence. [REDACTED] said that [REDACTED] was a friend of [REDACTED] and [REDACTED] when [REDACTED] was [REDACTED] but when [REDACTED] was [REDACTED] people did not want to hang out with him.

I asked [REDACTED] if [REDACTED] was [REDACTED] or if he just got "pissed off". [REDACTED] said [REDACTED] just got "pissed off". [REDACTED] added that [REDACTED] had never been violent toward him.

[REDACTED] said that he had tried to talk to [REDACTED] about his [REDACTED] but [REDACTED] said that he himself had also [REDACTED] so [REDACTED] would just put it back on [REDACTED] telling [REDACTED]

I asked [REDACTED] why [REDACTED] would shoot at law enforcement. [REDACTED] said that [REDACTED] probably did not even know he was shooting at law enforcement and [REDACTED] was probably scared. [REDACTED] told me when [REDACTED] becomes scared he "goes off".

I asked [REDACTED] if he ever saw [REDACTED] with any guns and [REDACTED] told me that [REDACTED] had a shotgun that was stolen from him about a year ago. This concluded my interview with [REDACTED]

On 6/30/07 at about 2057 hrs, I walked back down the driveway and met with Sergeant Guyer, Officer Spallino, Chief Hostler, [REDACTED] and Officer Nolan. I was meeting with these Officers to advise them that I needed to interview each of them. At this time, I heard a fluttering noise overhead and someone yelled, "He's shooting."

All of us that were in the area dropped down to the gravel driveway and I heard four to five gunshots. I heard radio traffic from the portable radios that the Officers around me had. The radio traffic stated that [REDACTED] had again fired at the Officers who were at the two Tribal units that were fired upon earlier that were about 50 yards west of my location.

Myself and the other Officers that were at my location returned to Lieutenant Cavinta's location that was closer to the intersection of the driveway and Bloody Camp Rd. I met

with Lieutenant Cavinta and he advised me that the Deputies that returned fire were Sergeant Bryan Quenell, Deputy Jamie Barney and Deputy Tony Gomes.

After meeting with Lieutenant Cavinta, I asked Sergeant Guyer to return to my vehicle so I could interview him, which he agreed to do. On 6/3/07 at about 2106 hrs, I interviewed Sergeant Guyer in my vehicle. The interview was digitally recorded and later placed onto CD. The following is a brief summary of the interview I conducted with Sergeant Guyer. Refer to the CD or transcript for further details.

I asked Sergeant Guyer if he had ever had any police contacts with [REDACTED] [REDACTED] in the past. Sergeant Guyer told me on 5/2/07, sometime after midnight, Sergeant Guyer was dispatched to [REDACTED] [REDACTED] residence that was located in Campbell Field Housing. Sergeant Guyer was dispatched to the residence to evaluate [REDACTED] well being. Sergeant Guyer [REDACTED] [REDACTED] [REDACTED] I asked Sergeant Guyer why [REDACTED] was [REDACTED]. Sergeant Guyer said that [REDACTED] was saying that he could not be hurt and that people were pointing lasers at his head. [REDACTED] also told Sergeant Guyer that he was indestructible and he could drink gasoline. [REDACTED] also wanted to be called by the name, [REDACTED]

I asked Sergeant Guyer if [REDACTED] was violent toward them. Sergeant Guyer said that [REDACTED] was aggressive but he did not fight Sergeant Guyer or the other Officers on scene. Sergeant Guyer added that [REDACTED] did have a sharpened butter knife on his person.

Sergeant Guyer said when [REDACTED] was placed into a patrol unit [REDACTED] began striking the windows of the patrol unit with his head. [REDACTED] [REDACTED]

I asked Sergeant Guyer if he had any other contacts with [REDACTED] Sergeant Guyer told me earlier in the week [REDACTED] had been cited for trespassing at the local casino.

I asked Sergeant Guyer what time he started to shift on 6/3/07, Sergeant Guyer told me that he was at his residence and at about 1520 hrs, Sergeant Guyer was called out of his residence by his dispatch. Dispatch advised Sergeant Guyer that [REDACTED] had barricaded himself in [REDACTED] residence and was armed with a gun and brandished a gun at Officers. Sergeant Guyer said that he responded from his residence and arrived on scene at about 1538 hrs.

Sergeant Guyer said when he arrived on scene he parked his patrol unit directly behind Chief Hostler's patrol unit, which was on the gravel driveway to the southeast of the south side of the residence. Sergeant Guyer said that he was advised that Deputy Greg Berry and Yurok Tribal Police Officer Heather Landreaneux were on the north side of the residence.

Sergeant Guyer told me that the patrol units were parked a distance away from the residence because of the information that [REDACTED] was armed. Sergeant Guyer said at one point after arriving on scene he saw [REDACTED] look out of a window on the southeast corner of

the residence. [REDACTED] went back into the residence and Sergeant Guyer could no longer see him.

Sergeant Guyer told me that he took a position of cover between the driver's side door and entrance into his vehicle. Sergeant Guyer had armed himself with his shotgun and covered the residence. Chief Hostler was in the same position as Sergeant Guyer but Chief Hostler was taking up a position at his patrol unit, which was in front of Sergeant Guyer's patrol unit.

Sergeant Guyer said that he and Chief Hostler stood by in these positions waiting for back up to arrive. Shortly after this, CHP Officer Nolan arrived on scene and took up a position at Sergeant Guyer's patrol unit. Shortly after Officer Nolan arrived on scene Sheriff's Office Sergeant Kevin Miller and Tribal Officer [REDACTED] Spallino arrived.

Sergeant Guyer said that he did not see any movement on the south side of the residence but he heard radio traffic from Deputy Berry that [REDACTED] was in and out of the north side of the residence and was armed with a firearm.

I asked Sergeant Guyer where the other patrol units were parked. Sergeant Guyer told me that Officer Nolan's patrol unit was behind his and Sergeant Miller's patrol unit was behind Officer Nolan's and Officer Spallino's patrol unit was behind Sergeant Miller's. Sergeant Guyer said the last Officer to arrive on scene was Deputy Brian Taylor and he parked his patrol unit behind Sergeant Miller's patrol unit.

Sergeant Guyer added that when [REDACTED] looked out of the residence he would be able to see the marked patrol units and Sergeant Guyer said when he first arrived on scene he also had his emergency lights activated.

Sergeant Guyer said that all of the patrol units had to park one behind the other due to the driveway being so narrow.

Sergeant Guyer said that Sergeant Miller contacted Deputy Taylor and had Deputy Taylor take over Chief Hostler's position at the front patrol unit since Deputy Taylor was a member of the Sheriff's Office SET team. Sergeant Guyer said that Deputy Taylor took the position at the first patrol unit on the driver's side and Officer Spallino was now on the passenger side of this patrol unit. Sergeant Guyer was now positioned on the passenger side of the second patrol unit and Officer Nolan was on the driver's side of this unit. All of the Officers had their weapons drawn and were covering the residence.

Sergeant Guyer said for about five minutes nothing went on at the residence until [REDACTED] came to the window on the left side and yelled out to the Officers, "You guys better back off I got my M-16 and I'm going to take you all out."

Sergeant Guyer said that [REDACTED] then walked away from the window and he lost sight of [REDACTED]. Sergeant Guyer said about two to three minutes later he saw the black barrel of a gun come out of the same window [REDACTED] was just yelling out. Sergeant Guyer said the

barrel pointed toward he and the other Officers' direction and the Officers notified each other by stating "gun, gun". Sergeant Guyer said after this was said Sergeant Guyer said he heard two gunshots and retreated to the rear of the patrol unit he was positioned at and Sergeant Guyer said he heard a third gunshot at that point. Sergeant Guyer said the Officers on scene made a quick check to make sure no one had been shot and everyone was okay. Sergeant Guyer returned to the driver's side of the patrol unit and he noticed that the windshield to his patrol unit had been hit. Sergeant Guyer said that the Officers radioed that shots had been fired and the Officers stayed positioned at the patrol units. Sergeant Guyer said that he no longer saw the barrel of the gun sticking out of the window when he returned to his position.

Sergeant Guyer said other Officers arrived on scene and Sergeant Guyer and the other Officers were relieved of their position.

I asked Sergeant Guyer how long he and the other Officers were positioned at the two Tribal Police units and Sergeant Guyer estimated it was about two and a half to three hours.

I asked Sergeant Guyer where his shotgun was at this time and he told me that he had secured it in Deputy Mabry's patrol unit. I asked Sergeant Guyer if he had shot any rounds and Sergeant Guyer said he had not. I asked Sergeant Guyer if he knew who had returned fire at [REDACTED] Sergeant Guyer said after he had asked if everyone was okay Sergeant Miller asked who returned fire and Deputy Taylor had stated that he had shot one round.

I asked Sergeant Guyer if he had heard anything else coming from the residence. Sergeant Guyer told me since the standoff had begun he had heard yelling coming from the residence but he could not make out what was being said.

Sergeant Guyer stated since the first shots had been fired there had been other shots fired also, which I was present for with Sergeant Guyer before I interviewed him.

I asked Sergeant Guyer when he saw the barrel the gun if he could tell what type of firearm it was. Sergeant Guyer said all he could tell was that the firearm was a rifle. This concluded my interview with Sergeant Guyer.

After speaking with Sergeant Guyer, I made a weapons check of Sergeant Guyer's duty weapon. Sergeant Guyer was carrying a Glock 22, 40 caliber, semi-automatic handgun with a serial number of [REDACTED]. Sergeant Guyer had 1 round in the chamber and 15 rounds in the magazine. On Sergeant Guyer's duty belt he had two additional magazines with 15 rounds each for a total of 46 rounds. Sergeant Guyer advised me that he would retrieve his shotgun from Deputy Mabry's patrol unit and return to my location so the rounds could be counted for that firearm. I digitally photographed Sergeant Guyer and his duty weapon. The photographs were later placed onto CD and booked into evidence at the Sheriff's Office.

I next met with Tribal Police Officer [REDACTED] Spallino who was standing near my vehicle. I asked Officer Spallino to enter my vehicle so I could interview him, which he did. The interview with Officer Spallino was digitally recorded and later placed onto CD. The following is a brief summary of the interview I conducted with Officer Spallino. Refer to the CD or transcript for further details.

Officer Spallino told me that on 6/30/07 at about 1600 hrs, he was telephoned at his residence in McKinleyville, Ca. by Tribal Police dispatch and requested to respond to the Bloody Camp Rd. area. Dispatch advised Officer Spallino that [REDACTED] [REDACTED] was barricaded inside of a residence and was armed with a gun. Officer Spallino responded from his residence and arrived on scene. Officer Spallino could not recall what time he had arrived.

Officer Spallino said when he arrived on scene he drove down the driveway and parked behind the other patrol units that had already arrived. Officers Spallino met with Chief Hostler, Sergeant Guyer, Sergeant Miller and Officer Nolan. Officer Spallino said that Deputy Taylor arrived on scene shortly after himself.

Officer Spallino said that he was advised by the other Officers on scene that before his arrival [REDACTED] had come to a window and was yelling toward the Officers but Officer Spallino did not know what [REDACTED] said. Officer Spallino was advised that Deputy Berry and Officer Landreneaux were pinned down on the other side of the residence.

Officer Spallino said that when he exited his patrol unit he armed himself with his AR-15 and positioned himself behind the first Tribal unit. When Deputy Taylor arrived on scene Sergeant Miller had Deputy Taylor take a position at the driver's side door of this patrol unit and had Officer Spallino hold a position at the passenger side door. Officer Spallino said that at that point he covered the south side of the residence by pointing his AR-15 in the direction of the residence.

Officer Spallino said that about 20 minutes past by and he did not see or hear anything coming from the residence. Officer Spallino said he then saw a [REDACTED] come to a window on the south side of the residence who was wearing a red shirt. Officer Spallino recognized this person as [REDACTED] [REDACTED]. I asked Officer Spallino how he knew it was [REDACTED] and Officer Spallino told me that about one week ago [REDACTED] [REDACTED]. Officer Spallino told me on this occasion he was called out of his residence to respond to [REDACTED] parent's residence. When Officer Spallino arrived on scene Sergeant Guyer already had [REDACTED] detained. Officer Spallino said that [REDACTED] was already in Sergeant Guyer's patrol unit but Officer Spallino spoke with [REDACTED] briefly. [REDACTED] told Officer Spallino that he was a [REDACTED] that he had lasers coming out of his head, and that people were trying to kill him. [REDACTED] was eventually transported by ambulance and Officer Spallino followed the ambulance to the Arcata area at which time the ambulance personnel notified Officer Spallino that he was no longer needed. [REDACTED] [REDACTED]
[REDACTED]

I asked Officer Spallino to go back to when he saw [REDACTED] standing in the window on today's incident. Officer Spallino said that [REDACTED] spit out the window and said that he was going to get his M-16 and cap all of the Officers if they did not leave.

Officer Spallino said that [REDACTED] walked away from the window and about five minutes later Officer Spallino was still covering the residence with his AR-15. Officer Spallino heard Deputy Taylor state "he has a gun" and Officer Spallino saw a black colored barrel sticking out of the window pointing in the Officers' direction. Officer Spallino said shortly after he saw the barrel, [REDACTED] fired two shots and Officer Spallino went to the ground behind the passenger side door. Officer Spallino said that Deputy Taylor returned fire by shooting one round from his AR-15. Officer Spallino said he stayed behind the passenger side door for a short time and then retreated behind the patrol unit. Officer Spallino said that he did not see Deputy Taylor fire his weapon but Officer Spallino did hear Deputy Taylor state that he had returned fire.

Officer Spallino said that he met with Deputy Taylor and Deputy Taylor advised Officer Spallino that [REDACTED] had shot the windshield to the patrol unit they were taking cover behind.

Officer Spallino said that he stayed behind the patrol unit for approximately 10 minutes until SET team members relieved him.

I asked Officer Spallino if he had fired any of his weapons and he advised me that he did not. Officer Spallino added that he did notice two bullet holes in the windshield of the patrol unit he was taking cover by and an additional bullet hole in the patrol unit that was parked directly behind the unit Officer Spallino was positioned.

Officer Spallino stated that he also heard shots fired later on when he was speaking to me. Officer Spallino did not observe any of these shots being fired. This concluded my interview with Officer Spallino.

After speaking with Officer Spallino I made a weapons check on the weapons he was carrying at the time of the incident. Officer Spallino provided me with his AR-15 that was a .223 caliber rifle. The make of the rifle was a Colt and had a serial number of [REDACTED]. Officer Spallino had one round in the chamber of the rifle and 27 rounds in the magazine. I asked Officer Spallino why he only had 27 rounds in a 30 round magazine and Officer Spallino said that he did not always make sure that his magazines were filled to capacity.

I next checked Officer Spallino's duty weapon, which was a Glock 22, 40 caliber semi-automatic handgun. The serial number to this handgun was [REDACTED]. Officer Spallino had one round in the chamber and there were 13 rounds in the magazine. The other two magazines that were on Officer Spallino's duty belt were filled to capacity with 15 rounds each. Officer Spallino told me that he did not know that he only had 13 rounds in the magazine of his Glock handgun.

After completing the check of Officer Spallino's weapons, I digitally photographed Officer Spallino and his weapons and later placed the photographs onto CD. The CD was then placed into evidence.

On 6/3/07 at about 2156 hrs, I met with Sergeant Guyer at my vehicle and he had retrieved the shotgun that he was armed with when he had arrived on scene. I made a check of the shotgun, which was a Remington 870 with a serial number of [REDACTED]. The shotgun was loaded with four slug rounds and had four 00 buck rounds in the stock. I also photographed the shotgun and later placed the photographs onto CD.

On 6/3/07 at about 2202 hrs, I met with CHP Officer Mike Nolan at my vehicle. At this time, I made a weapons check on the firearms that Officer Nolan was carrying with him when the first shots were fired. Officer Nolan provided me with a Colt Sportster, which was also known as an AR-15 rifle. This rifle was .223 and caliber and had a serial number of [REDACTED].

Officer Nolan had 1 round in the chamber and 20 rounds in a 20 round magazine. Officer Nolan also had two extra 20 round magazines that were fastened to the stock of the rifle both of these magazines were filled to capacity with 20 rounds each.

Officer Nolan then provided me with his duty weapon, which was a Smith & Wesson, 4006 TSW 40 caliber semi-automatic handgun with a serial number of [REDACTED]. The firearm was loaded with 1 round in the chamber and 11 rounds in the magazine. Officer Nolan also had two additional magazines on his duty belt that were also filled to capacity with 11 rounds each.

At about 2208 hrs, I interviewed Officer Nolan in my vehicle and the interview was digitally recorded and later placed onto CD. The following is a brief summary of the interview I conducted with Officer Nolan. Refer to the CD or transcript for further details.

Officer Nolan told me that he began his shift 6/3/07 at 1400 hrs and was to go off duty at 2230 hrs. At about 1530 hrs, Officer Nolan was contacted by his dispatch and was requested to respond to the Bloody Camp Rd. area to assist Sheriff's Deputies with a [REDACTED] that was in a residence brandishing a firearm at the Deputies.

Officer Nolan said that he responded and when he arrived on scene, he met with Chief Hostler, Sergeant Guyer and Officer Spallino. Officer Nolan said that he did not note the time that he arrived in the Bloody Camp Rd. area.

Officer Nolan said that he exited his patrol unit and took a position up at the driver's side door of the second Tribal patrol unit. Officer Nolan had armed himself with his AR-15 rifle and was covering the south side of the residence [REDACTED] [REDACTED] was located in.

Officer Nolan said that he could hear yelling coming from the residence but he could not make out what was being said. Officer Nolan said that he could not recall any of the Officers on scene yelling anything toward the residence.

Officer Nolan said by this time Deputy Taylor had arrived on scene and Deputy Taylor had taken a position at the driver's side of the first Tribal patrol unit. Officer Nolan said that he saw a male [REDACTED] in one of the windows on the south side of the residence and Officer Nolan believed the male was wearing something red on his head. Officer Nolan said that he could see something coming from the window but could not make out what it was except for hands that Officer Nolan could see. Officer Nolan said there were three to four "popping sounds", which he believed to be gunshots. Officer Nolan ducked and took cover behind the patrol unit door. Officer Nolan said when he took cover he could feel some type of particles falling on him from above the opened door. Officer Nolan stated that later he noticed that the patrol unit he was positioned at had a gunshot hole in the windshield.

Officer Nolan said after the shots were fired he retreated to the rear of the patrol unit he was at and met with Sergeant Guyer at this location. Officer Nolan stayed at the rear of the patrol unit until other Officers that had responded relieved him.

I asked Officer Nolan how long he was at the rear of the patrol unit until he was relieved. Officer Nolan said that it was not that long of a period but he did not know how many minutes.

Officer Nolan also stated that while he was on scene he had heard more gunfire in the area but was not present when this occurred. I confirmed with Officer Nolan if he was referring to the second time that shots were fired and he said that was correct. This concluded my interview with Officer Nolan.

On 6/3/07 at about 2025 hrs, I met with Deputy Greg Berry in my vehicle. The interview I conducted with Deputy Berry was digitally recorded and later placed onto CD. The following is a brief summary of the interview. Refer to the CD or transcript for further details.

Deputy Berry told me on 6/3/07 at about 0800 hrs, he began his shift and was to end his shift at 1700 hrs. Deputy Berry said that later in the day, he met with Yurok Tribal Police Officer Heather Landreneaux and they "doubled up" because Officer Landreneaux had just gotten a new patrol unit. Deputy Berry said that they drove to Orleans, Ca. so they could post some reward posters throughout the town for an arson that had occurred in the Orleans area.

Deputy Berry said that at about 1400 to 1430 hrs, he and Officer Landreneaux were dispatched to the Bloody Camp Rd. area for a welfare check of [REDACTED] [REDACTED]. Deputy Berry said that they were to respond because the Officer that was on for the Hoopa Tribal Police Department was en route to Eureka.

Deputy Berry said that as they were driving up Bloody Camp Rd. they met with [REDACTED] who was driving a [REDACTED] pickup truck. [REDACTED] asked Deputy Berry if he was bringing more people with him and Deputy Berry asked [REDACTED] why more people were needed. [REDACTED] told Deputy Berry that [REDACTED] had just shown up at her and [REDACTED] residence and they had not seen [REDACTED] for about four to five years. [REDACTED] was telling [REDACTED] and [REDACTED] that he just needed a place to sleep. [REDACTED] said that she telephoned [REDACTED] mother, [REDACTED] [REDACTED] and [REDACTED] told [REDACTED] that [REDACTED] was at her residence. [REDACTED] told [REDACTED] that someone needed to go to [REDACTED] residence because [REDACTED].

[REDACTED] told Deputy Berry that [REDACTED] told her that [REDACTED] had made threats of doing harm to [REDACTED] youngest daughter. I asked Deputy Berry if he had spoken to [REDACTED] and he told me he had over [REDACTED] cellular phone. Deputy Berry asked [REDACTED] why it was determined by her that [REDACTED] so that [REDACTED] did mention to Deputy Berry that [REDACTED] had threatened to do harm [REDACTED] and that [REDACTED] [REDACTED] was trying to help [REDACTED] out but [REDACTED] was talking about [REDACTED] property.

According to Deputy Berry, [REDACTED] told him that [REDACTED] gave [REDACTED] a ride to an unknown location and dropped him off. [REDACTED] assumed that was when [REDACTED] walked to [REDACTED] and [REDACTED] residence.

Deputy Berry asked [REDACTED] how [REDACTED] responded toward law enforcement. [REDACTED] told Deputy Berry that Officer Mike Roberts was aware of the situation with [REDACTED] Officer Roberts had dealt with [REDACTED] in the past and [REDACTED] was cooperative with Officer Roberts. Deputy Berry telephoned Officer Roberts via cellular phone and spoke to him in regards to [REDACTED].

Deputy Berry told [REDACTED] that he and Officer Landreneaux would respond to [REDACTED] residence to talk with [REDACTED] to determine if [REDACTED].

Deputy Berry and Officer Landreneaux followed [REDACTED] to the driveway of her residence. [REDACTED] stated that she was not going to go to the residence because she had her children with her. I asked Deputy Berry why [REDACTED] was so worried about [REDACTED] Deputy Berry said that [REDACTED] told him that [REDACTED] was talking to himself and acting strangely by stating that he did not want to be around anymore.

Deputy Berry said as he and Officer Landreneaux drove up to a [REDACTED] trailer with an add on Deputy Berry saw two male [REDACTED] standing on the front porch. Deputy Berry said that [REDACTED] [REDACTED] was standing near the porch on the ground and [REDACTED] was standing actually on the porch just outside the front door. Deputy Berry said that Officer Landreneaux was driving the patrol unit and he was in the passenger seat and Officer

Landreneaux pulled the patrol unit into the driveway so it was facing toward the front door of the residence and [REDACTED]

Deputy Berry said that he and Officer Landreneaux were parked about 30 to 40 feet away from [REDACTED] [REDACTED] walked over to the patrol unit and spoke to Deputy Berry at the passenger side of the vehicle. [REDACTED] asked [REDACTED] why law enforcement was at the residence and [REDACTED] told [REDACTED] that he thought that Deputy Berry and Officer Landreneaux should speak to him. [REDACTED] began to pull knives out from either his pant's pockets or waistband and [REDACTED] tucked about four to five knives into the front of his belt. [REDACTED] told [REDACTED] that he was "pissed off" and told Deputy Berry and Officer Landreneaux, "You mother fuckers get out of here I don't want you here."

Officer Landreneaux ordered [REDACTED] to drop the knives but he did not comply and stood on the porch for several more minutes but did not advance on Deputy Berry and Officer Landreneaux. [REDACTED] went into the residence and shut the front door.

Deputy Berry said that he lost sight of [REDACTED] and [REDACTED] walked over to the driver's side of the patrol unit and met with Officer Landreneaux. Deputy Berry said that about 15 feet from the driver's side of the patrol unit was a closed sliding glass window that he believed led to a bedroom. Deputy Berry heard [REDACTED] yell to Officer Landreneaux that [REDACTED] was pointing a gun at them. Deputy Berry said that he looked at this sliding glass window and he could not see into it because of the glare that was coming off it. Officer Landreneaux told Deputy Berry that she saw [REDACTED] with a gun in the window.

Deputy Berry said at this point, he radioed dispatch and advised them that [REDACTED] was inside of the residence pointing a firearm at them. Deputy Berry said that he went to the rear of the patrol unit to take cover and Officer Landreneaux and [REDACTED] followed. [REDACTED] told Deputy Berry that he did not have any idea how [REDACTED] got a gun because [REDACTED] had locked them up in his safe. Deputy Berry asked [REDACTED] what type of guns he had and [REDACTED] told Deputy Berry that he had a 22 caliber rifle with a scope, which [REDACTED] stated was what he thought [REDACTED] had armed himself with, an AK-47, AR-15 and a 45 caliber handgun. [REDACTED] added that he did not believe there was any ammunition outside of the gun safe.

Deputy Berry said that he and Officer Landreneaux had now switched positions at the rear of the patrol unit and he was at the rear passenger side and she was now at rear driver's side. Officer Landreneaux yelled out that [REDACTED] was now at the front door of the residence armed with a rifle and pointing the rifle toward the patrol unit. Deputy Berry was able to see [REDACTED] standing at the front door of the residence and he was pointing the rifle toward the patrol unit. Deputy Berry said that [REDACTED] did this for several moments and while [REDACTED] was standing at the front door, he was cocking the rifle. Deputy Berry was unsure what [REDACTED] cocking and/or clicking on the rifle. The next thing that [REDACTED] did was go back into the residence and shut the front door.

Deputy Berry said that he got onto the patrol units public address system and Deputy Berry was telling [REDACTED] that he was not going to go to jail that they only wanted to speak

to him. Deputy Berry said [REDACTED] came out of the front door and was still pointing the rifle toward the patrol unit and continued to "click" the rifle. [REDACTED] did this for several minutes, went back into the residence, and shut the front door.

Deputy Berry spoke to Officer Landreneaux and told her that they were in a bad tactical position. Deputy Berry told Officer Landreneaux that one of them was going to have to back the patrol unit away from the residence. Deputy Berry said that he was able to enter the patrol unit from the driver's side door and he ducked behind the dash of the patrol unit and he was able to back it up the driveway that led to [REDACTED] residence. Deputy Berry said as he did this Officer Landreneaux and [REDACTED] stayed at the rear of the patrol unit.

Deputy Berry said that he was able to get the patrol unit about 100 feet up the driveway to the north of the residence [REDACTED] was in at which time [REDACTED] again appeared at the front door of the residence. [REDACTED] was again pointing the rifle at the patrol unit and Deputy Berry stopped backing the patrol unit and went to the back of the patrol unit with Officer Landreneaux and [REDACTED]. At this point, Deputy Berry said Officer Landreneaux and [REDACTED] yelled out that [REDACTED] also had a handgun. Deputy Berry said that he did not see the handgun he only saw [REDACTED] with the rifle.

I asked Deputy Berry how [REDACTED] was holding the rifle when he was pointing it toward them. Deputy Berry said it looked like [REDACTED] was looking either into the sights on the rifle or into a scope.

Deputy Berry he said that [REDACTED] again went back into the residence shutting the front door. Deputy Berry again went into the patrol unit via the driver's side door and backed the patrol unit up about another hundred feet. Deputy Berry said that they were now about 250 to 300 feet away from the front door of the residence. Deputy Berry said from this distance he could still see the front door to the residence and radioed dispatch for more back up. Deputy Berry said that it was about 45 minutes to one hour before any of the back up units arrived on scene.

I asked Deputy Berry if he had seen [REDACTED] during the time that he was waiting for backup units to arrive. Deputy Berry said that he saw [REDACTED] numerous times but [REDACTED] could not see Deputy Berry, Officer Landreneaux and [REDACTED] because they were behind the patrol unit. Deputy Berry added that [REDACTED] would have been able to see the patrol unit from the front door of the residence.

I asked Deputy Berry during this time what [REDACTED] was doing and Deputy Berry said that he could see [REDACTED] aiming the rifle at the patrol unit and Deputy Berry could hear the clicking from the gun that he described earlier. Deputy Berry estimated that [REDACTED] had done this 8 to 10 times.

I asked Deputy Berry if he and Officer Landreneaux had their duty weapons drawn at anytime during this incident. Deputy Berry said that he had armed himself with his Glock 40 caliber handgun. Deputy Berry said that he had also later armed himself with

Officer Landreneaux's issued shotgun and a loaded it with slug rounds because of the distance that they were from [REDACTED] Deputy Berry said that he and Officer Landreneaux traded off with the shotgun while they were taking cover behind the patrol unit.

Deputy Berry said that neither he nor Officer Landreneaux exchanged gunfire with [REDACTED] Deputy Berry said that he did hear gunshots sometime after Deputy Taylor arrived on scene. Deputy Berry said he believed that Deputy Taylor was positioned somewhere east of the residence [REDACTED] was in and that two patrol units had been shot at that location. Deputy Berry said that the first time he heard gunshots he believed he heard four in total.

Deputy Berry said that he had also heard more gunshots later on. Deputy Berry said after SET team members arrived and relieved Deputy Berry and Officer Landreneaux. Deputy Berry said while he and Officer Landreneaux were walking to [REDACTED] residence they heard several more gunshots and Deputy Berry and Officer Landreneaux retreated to the cover of the patrol unit. Deputy Berry said that he believed this occurred around 2100 hrs, and he heard three gunshots in total.

I asked Deputy Berry if he or anyone else that he was around during this incident had fired a weapon. Deputy Berry said that neither he nor Officer Landreneaux had fired their weapons.

Deputy Berry told me that [REDACTED] had left the patrol unit before Deputy Berry and Officer Landreneaux to retreat to [REDACTED] residence because he was ill due to a spider bite.

I asked Deputy Berry what he thought when [REDACTED] was pointing the rifle at him and Officer Landreneaux. Deputy Berry said that he thought [REDACTED] was going to shoot himself and Officer Landreneaux. Deputy Berry recalled at one point he told [REDACTED] that he was going to back up the patrol unit and [REDACTED] replied by telling Deputy Berry that the patrol unit was now his and they needed to leave running.

Deputy Berry believed that [REDACTED] did meet the criteria for [REDACTED] because [REDACTED] was threatening the lives of himself, Officer Landreneaux and [REDACTED]

Deputy Berry told me that [REDACTED] had told him that [REDACTED] stated to [REDACTED] that he was not [REDACTED] alive. This concluded my interview with Deputy Berry.

After speaking with Deputy Berry, I made a weapons check of Deputy Berry's duty weapon. Deputy Berry provided me with a Glock 22, 40 caliber semi-automatic handgun. The serial number to the handgun was [REDACTED] The handgun was loaded with one round in the chamber and 15 rounds in the magazine. Deputy Berry had two additional magazines that were on his duty belt each magazine was filled to capacity with 15 rounds a piece.

On 6/30/07 at about 2320 hrs, Deputy Berry again met with me at my vehicle. He provided me with the shotgun that he and Officer Landreneaux had armed themselves

with. The shotgun was a Remington 870 with a serial number of [REDACTED]. The shotgun was loaded with one slug round in the chamber and three slug rounds in the tube. There were an additional three rounds in the stock of the shotgun. I photographed Deputy Berry; his duty weapon and the shotgun that he provided me. The photographs of these weapons were later placed onto CD.

On 6/3/07 at about 2325 hrs, I met with Yurok Tribal Police Officer Heather Landreneaux at my vehicle. I interviewed Officer Landreneaux in my vehicle and the interview was digitally recorded. I later placed the interview onto CD and the following is a brief summary of the interview I conducted with Officer Landreneaux. Refer to the CD or transcript for further details.

Officer Landreneaux told me that on 6/3/07 she began her shift at 0800 hrs and was to end her shift at 2200 hrs. Officer Landreneaux told me that she and Deputy Greg Berry were working as a doubled unit in the Orleans area. They received a dispatch call for a welfare check on Bloody Camp Rd. Officer Landreneaux said as they were responding to the residence a [REDACTED] pickup truck passed by them and Deputy Berry noticed that the truck was turning around and Officer Landreneaux pulled her patrol unit over so she and Deputy Berry could speak to the occupants. Officer Landreneaux and Deputy Berry met with [REDACTED] at the [REDACTED] pickup truck.

[REDACTED] told Officer Landreneaux and Deputy Berry that she was speaking to [REDACTED] mother via cellular phone. Deputy Berry was given the cellular phone and began speaking to [REDACTED] mother. While Deputy Berry was doing this, Officer Landreneaux said that she spoke with [REDACTED] told Officer Landreneaux that [REDACTED] had not seen [REDACTED] since he was a young child and [REDACTED] had just shown up at [REDACTED] residence.

[REDACTED] said that [REDACTED] mother, [REDACTED] had told [REDACTED] that [REDACTED] had been making threats toward her. [REDACTED] went on to tell Officer Landreneaux that [REDACTED] did not look right and was acting strangely. [REDACTED] said that she felt threatened by [REDACTED] so she took her children and left her residence.

[REDACTED] then drove her vehicle to a driveway and Officer Landreneaux and Deputy Berry followed. [REDACTED] told them that [REDACTED] and [REDACTED] were in a [REDACTED] colored residence down this driveway.

Officer Landreneaux and Deputy Berry drove down the driveway to a residence. Officer Landreneaux was driving and Deputy Berry was in the passenger seat. When they arrived at the front of the residence, [REDACTED] walked out of the residence and met with Officer Landreneaux and Deputy Berry. [REDACTED] followed behind [REDACTED] and stood on the front porch of the residence. Officer Landreneaux said that Deputy Berry was talking to [REDACTED] and Officer Landreneaux saw [REDACTED] pull two knives from his waistband, which Officer Landreneaux believed to be butter knives. When [REDACTED] pulled the knives, he began waving them around in his hands. Officer Landreneaux said when [REDACTED] was doing this her patrol unit was facing him.

Officer Landreneaux ordered [REDACTED] to put the knives down several times, which he did not do but he placed them into his waistband. Deputy Berry radioed dispatch and advised them of the situation.

[REDACTED] told Officer Landreneaux and Deputy Berry that [REDACTED] had just shown up at his residence unannounced and that [REDACTED] was talking to himself.

Officer Landreneaux noticed that [REDACTED] began stepping back into the front door of the residence and she ordered him to stay where they could see him. [REDACTED] did not comply and went back into the residence and shut the front door.

When [REDACTED] went into the residence [REDACTED] told Officer Landreneaux and Deputy Berry that [REDACTED] had all of his weapons in a safe except for a 22 caliber rifle and that the ammunition for the rifle was in a drawer in the residence. [REDACTED] said that he had a shotgun, a rifle, an AR-15 and an AK-47 that were locked in a safe with ammunition that was inside of the residence.

At this time, Officer Landreneaux noticed [REDACTED] standing in a window that was near the driver's side door of her patrol unit. Officer Landreneaux saw [REDACTED] pointing a rifle through the window at them. Officer Landreneaux and Deputy Berry both drew their handguns from their duty belts. Officer Landreneaux and Deputy Berry were ordering [REDACTED] to drop the weapon and to come outside.

I asked Officer Landreneaux if [REDACTED] was saying anything to them and Officer Landreneaux told me that [REDACTED] only interacted with them when he was first out on the front porch and was telling Officer Landreneaux and Deputy Berry to leave.

Officer Landreneaux said that [REDACTED] came to the window once or twice more brandishing the rifle as they were trying to figure out what to do. Officer Landreneaux said that she, Deputy Berry and [REDACTED] had taken a position of cover behind her patrol unit. When [REDACTED] had disappeared from the window Officer Landreneaux went up to the driver's side of her vehicle and was able to get inside and back her patrol unit up several feet. [REDACTED] appeared at the front door of the residence and pointed the rifle at them again and Officer Landreneaux stopped backing her patrol unit up at that time. Officer Landreneaux said that she and Deputy Berry had their weapons pointed at [REDACTED] and were telling [REDACTED] to drop the weapon, which [REDACTED] did not comply with and [REDACTED] went back into the residence. Shortly after this, [REDACTED] again came out the front door and was armed with a handgun [REDACTED] told Officer Landreneaux and Deputy Berry that he thought [REDACTED] was armed with a toy gun because [REDACTED] believed he did not own any handguns. Officer Landreneaux said that [REDACTED] pointed the handgun at them and was making hand gestures as if to say to Officer Landreneaux and Deputy Berry to shoot him. After [REDACTED] had done this, he went back into the residence and shut the front door.

Officer Landreneaux and Deputy Berry determined that they needed to back the patrol unit up even farther. Deputy Berry backed up the patrol unit on this occasion while

Officer Landreneaux and [REDACTED] took cover behind the patrol unit. Officer Landreneaux said that she covered the residence with her handgun as Deputy Berry backed the patrol unit.

Officer Landreneaux said that since they had taken up the new position farther from the residence she could see [REDACTED] go back and forth from the window she first saw him at to the front door of the residence. Each time [REDACTED] would move locations he would still point the rifle at the patrol unit. Officer Landreneaux did recall that on one of the occasions that [REDACTED] came out of the front door he was dancing around and yelling to Officer Landreneaux and Deputy Berry to come and get him. [REDACTED] also stated that he had killed people before and that he was not going to go back to [REDACTED]. Officer Landreneaux recalled that on several occasions when [REDACTED] came outside he would dry fire the rifle.

Officer Landreneaux told me that she, Deputy Berry and [REDACTED] stayed at the location of the patrol unit for about 30 minutes until backup units arrived. Officer Landreneaux said that she and Deputy Berry eventually retrieved her issued shotgun out of her patrol unit and took turns arming themselves with it.

I asked Officer Landreneaux if she ever heard any gunshots. Officer Landreneaux said that she did and it was shortly after the backup units arrived on scene. Officer Landreneaux said that she could not see anyone firing the gunshots but believed that she heard three shots fired. Officer Landreneaux said at about 2030 hrs, SET team members had arrived at Officer Landreneaux and Deputy Berry's location to relieve them. Officer Landreneaux said at that time she heard three more gunshots. Officer Landreneaux said that she did not see who fired the shots.

Officer Landreneaux said that when the SET team members relieved her and Deputy Berry they walked to [REDACTED] residence to see if [REDACTED] was with [REDACTED]. [REDACTED] had earlier left the cover of the patrol unit because he was not feeling well. [REDACTED] was not with [REDACTED]. [REDACTED] told Officer Landreneaux and Deputy Berry to keep walking up past his residence and they would come to the main road (Bloody Camp Rd.), so they would not be in harms way.

I asked Officer Landreneaux what the unit number of her patrol unit was and she said that it was 35.

I asked Officer Landreneaux what was going through her mind when [REDACTED] was pointing the rifle at her. Officer Landreneaux replied, "Holy shit."

Officer Landreneaux said that this was the first situation she had been in where she thought that she could be killed. I asked Officer Landreneaux why she and Deputy Berry did not shoot [REDACTED]. Officer Landreneaux said that she and Deputy Berry were armed with their handguns and close enough to shoot at [REDACTED]. It appeared to Officer Landreneaux that the rifle [REDACTED] had armed himself with did not have any ammunition in it so she did not fire her weapon. Officer Landreneaux also took into consideration that

█████ appeared to be █████. Officer Landreneaux believed what █████ had told her about the 22 caliber rifle not having ammunition and █████ continuing to just make the rifle click, which Officer Landreneaux believed █████ to be just dry firing the rifle. This concluded my interview with Officer Landreneaux.

After speaking with Officer Landreneaux, I made a weapons check of her issued handgun. Officer Landreneaux's handgun was a HK USP Compact, 9mm with a serial number of █████. Officer Landreneaux's handgun was loaded with one round in the chamber and 10 rounds in the magazine. She also had two magazines on her duty belts filled to capacity with 10 rounds a piece. I digitally photographed Officer Landreneaux and her duty weapon and later placed the photos onto CD.

On 6/4/07 at about 0005 hrs, I met with Deputy Greg Berry and ascertained from him the telephone number for █████. Deputy Berry provided me with █████ cellular phone number, which was █████. I telephoned this number, spoke with █████ and asked him if he could meet with me on Bloody Camp Rd. █████ said that he was no longer in that area but he could meet with me in several minutes.

On 6/4/07 at about 0019 hrs, I met with █████ on Bloody Camp Rd. I asked █████ if I could speak to him in my vehicle and he agreed to do so. I interviewed █████ and the interview was digitally recorded and later placed onto CD. The following is a brief summary of the interview I conducted with █████. Refer to the CD or transcript for further details.

I asked █████ how he knew █████ and █████ said that years ago █████ resided in this area. █████ said that █████ would come to his house from time to time and watch television.

█████ added that he felt █████ came to his residence because years ago █████ came to █████ residence after escaping from law enforcement and █████ was handcuffed. █████ estimated that this occurred about seven years ago. █████ said that when █████ arrived at his residence he sawed the handcuffs off █████. █████ said that █████ was on █████ on this occasion. █████ believed that because of this incident █████ felt he could come to █████ for help. █████ said that this was the last time that he had seen █████ at his residence until this day.

█████ said on 6/3/07, sometime after noon, he was lying in bed because he was not feeling well due to a spider bite. █████ said the next thing that he knew was that █████ just walked into his residence unannounced. █████ said that immediately he noticed that something was wrong with █████. When █████ met with █████ stated, █████

█████ said at first he did not recognize █████ and asked his girlfriend █████ who this person was. █████ then recognized █████ and █████ could see that █████ was clenching his jaws. █████ said that █████ was wearing a large amount of clothing and did not understand why since the weather was warm outside. █████ told █████ that

he had walked all the way to his residence. [REDACTED] said that he later learned that [REDACTED] received a ride from the [REDACTED] family and was dropped off at [REDACTED] and [REDACTED] driveway.

I asked [REDACTED] when he met with [REDACTED] what [REDACTED] was saying to him. [REDACTED] told [REDACTED] that he was "on the run", [REDACTED] asked [REDACTED] what he had done this time, and [REDACTED] said nothing. [REDACTED] told [REDACTED] that he was just tired and [REDACTED] got into bed with [REDACTED]. Before [REDACTED] got into bed with [REDACTED] [REDACTED] said that [REDACTED] called him "dad". [REDACTED] added that [REDACTED] was also calling [REDACTED] "mom".

[REDACTED] said that he got out of bed and asked [REDACTED] what was going on. [REDACTED] told [REDACTED] that he got into an altercation with his mother and "fucked up" his brother's residence. [REDACTED] told [REDACTED] that he was not going back alive. At about this time, [REDACTED] got out of [REDACTED] bed and [REDACTED] showed [REDACTED] a two-pronged knife. [REDACTED] then noticed that [REDACTED] had two kitchen knives in his belt near his belt buckle. [REDACTED] was also armed with a large knife and then pulled out to additional knives from his boots. [REDACTED] estimated that all together [REDACTED] was armed with six knives.

[REDACTED] said while he was speaking to [REDACTED] [REDACTED] telephoned [REDACTED] mother [REDACTED] [REDACTED] told [REDACTED] that [REDACTED] was now at her and [REDACTED] residence and [REDACTED] told [REDACTED] that she had been looking for [REDACTED]

[REDACTED] met with [REDACTED] and he told [REDACTED] to leave the residence with their son and [REDACTED] nephew and to go to the end of the driveway and call law enforcement and not come back.

[REDACTED] told me that he was in fear of his safety and the persons around him due to the way [REDACTED] was acting. [REDACTED] told me that he even thought about taking [REDACTED] out on his own but [REDACTED] was so [REDACTED] [REDACTED] felt he would have to do something like strike [REDACTED] with a shovel so he would be [REDACTED]

[REDACTED] said that after sometime past, [REDACTED] came back to the residence and met with [REDACTED] [REDACTED] told [REDACTED] under her breath that she had called law enforcement and that they were en route to the residence. [REDACTED] left the residence at this point.

[REDACTED] said that he stayed in his residence with [REDACTED] and was trying to calm [REDACTED] down as much as he could. [REDACTED] recalled at one point, [REDACTED] was pointing at some triangle tattoos that he had on him and [REDACTED] was telling [REDACTED] that the triangles stood for people that [REDACTED] had killed. [REDACTED] said that [REDACTED] went on telling him that he had killed people throughout the Hoopa Valley. [REDACTED] mentioned to [REDACTED] that he needed to kill some more people and at this point [REDACTED] wondered to himself where he fit into this equation.

[REDACTED] said that he was worried about his own safety and he knew law enforcement was en route to his home. [REDACTED] said that he had several firearms outside of his gun safe and knew that he needed to get the firearms into the safe. Not only was [REDACTED]

worried about the firearms that he had in his residence but the household utensils that were lying around. [REDACTED] said while [REDACTED] was not watching him, [REDACTED] would throw some of the utensils out of the windows of the residence.

[REDACTED] said [REDACTED] went back into [REDACTED] bedroom and [REDACTED] believed [REDACTED] was going to lie down on the bed. [REDACTED] said that he was able to put all of his firearms into his gun safe except for a 22 caliber rifle that [REDACTED] forgot about.

[REDACTED] said that he eventually walked into the bedroom and thought [REDACTED] would be lying down on the bed but [REDACTED] was looking out of the bedroom window and [REDACTED] was telling [REDACTED] that he felt something was going on.

[REDACTED] said that he was eventually able to get [REDACTED] to go into the kitchen of the residence. [REDACTED] tried to have [REDACTED] sit at the kitchen table so [REDACTED] could sit in a chair that looked out the kitchen window so he could see the law enforcement Officers arriving. [REDACTED] said that this did not work though because [REDACTED] sat in the chair that faced out the kitchen window toward the driveway.

[REDACTED] said that he and [REDACTED] sat at the kitchen for a while but [REDACTED] was becoming increasingly agitated. [REDACTED] said that [REDACTED] saw the patrol unit driving on the driveway to the residence and [REDACTED] looked down at the ground and seemed to [REDACTED] to be confused. [REDACTED] knew at this time that he needed to leave the residence and walked out the front door. [REDACTED] said as he was walking out the front door he could hear [REDACTED] calling him "dad" and asking [REDACTED] why he did this to him.

[REDACTED] said that he walked over to the patrol unit and [REDACTED] followed [REDACTED] but stopped at the doorway of the front door to the residence. [REDACTED] said that he met with Deputy Greg Berry and that Deputy Berry was out of the patrol unit and [REDACTED] was armed with two knives and was striking them together. Deputy Berry was armed with a tazer gun. [REDACTED] was asking Deputy Berry and Officer Heather Landreneaux what they were doing at the residence and to "get the fuck out of here ". [REDACTED] said at this point, Deputy Berry put away his tazer and pulled out his Glock handgun. [REDACTED] said that [REDACTED] started to walk down the steps from the porch and Deputy Berry and Officer Landreneaux told [REDACTED] not to come down the steps. [REDACTED] stopped and went back up on the porch and told Deputy Berry and Officer Landreneaux to leave the property because [REDACTED] was not going anywhere. [REDACTED] went back into the residence and closed the front door.

[REDACTED] said that he and the Officers were taking cover behind the patrol unit and Deputy Berry was asking [REDACTED] what firearms he had in the residence. [REDACTED] told Deputy Berry what weapons were in the residence and at this time was when [REDACTED] recalled forgetting to put the 22 caliber rifle in the gun safe. [REDACTED] told Deputy Berry that the 22 caliber rifle was left in a gun rack inside of the residence.

[REDACTED] said at about this time, they noticed [REDACTED] standing in [REDACTED] back bedroom window, which faces north and [REDACTED] was pointing the 22 caliber rifle at them. [REDACTED]

said that he, Deputy Berry and Officer Landreneaux took cover behind the patrol unit. [REDACTED] told Deputy Berry and Officer Landreneaux that he had a gun safe in his residence and there was an AK-47, AR-15, shotgun loaded with slugs and a 45 caliber handgun in the safe. [REDACTED] said that he was worried about getting in trouble for possessing the AK-47 and AR-15 but he thought that the Officers' safety was more important.

[REDACTED] went on to tell me that the gun safe was a brown colored Hallmack and that it had two locking mechanisms. [REDACTED] said that the bottom locking mechanism did not work. [REDACTED] believed it would be possible for [REDACTED] to pry open the bottom of the safe and get to the firearms.

I asked [REDACTED] to describe the firearms that he had in his residence. [REDACTED] said that the gun that he forgot to put in the safe was a Remington 22 caliber rifle with a three to nine variable scope mounted on it and according to [REDACTED] the rifle was very accurate. In the safe was an AK-47, AR-15; Mossberg 500 pump shotgun, 45 caliber tactical response handgun made by Springfield Armory and a Winchester 22 caliber 16 shot rifle.

I asked [REDACTED] to tell me what type of ammunition was inside of his residence. [REDACTED] said that there was no ammunition for the AK-47, there was 40 rounds for the AK-47. [REDACTED] had about 400 rounds of 22 ammunition and several other boxes of 22 ammunition in a dresser drawer just below the rack that [REDACTED] had the 22 caliber rifle sitting in, which [REDACTED] had armed himself with. [REDACTED] did add that the rifle [REDACTED] had armed himself with was extremely dirty and would usually jam after firing three to four rounds. [REDACTED] said that he had about 20 rounds for the 45 caliber handgun but these rounds were locked in the safe. [REDACTED] had about 20 to 25 shotgun slug rounds that were locked in the safe.

[REDACTED] told me that he did have a bulletproof vest that was regulation three without the trauma plate that was in the main bedroom under a pile of clothing. [REDACTED] did not think [REDACTED] would find the vest unless [REDACTED] went digging through the pile of clothing. [REDACTED] added that he had a fake grenade in his residence. The grenade looked like it was real but it had no powder or charge in it.

I asked [REDACTED] where the key was for the safe. [REDACTED] said that he hid the key where the water tank closet was located in his residence. [REDACTED] said the key to the gun safe had two prongs.

I asked [REDACTED] if he ever heard any gunshots. That he said that at one point after meeting with Deputy Berry and Officer Landreneaux he heard two to three gunshots but that he did not see who had fired the shots. [REDACTED] said just before it became dark outside he also heard three to four gunshots and [REDACTED] did not see who fired these rounds. [REDACTED] told me that he was worried that [REDACTED] might burn his house down.

I asked [REDACTED] when [REDACTED] would point the rifle at he, Deputy Berry and Officer Landreneaux did he ever hear a clicking noise. [REDACTED] said when [REDACTED] first pointed the

rifle at them through the window he did not hear anything because the window was closed. ██████ said as Deputy Berry and Officer Landreneaux backed the patrol unit up farther away from the residence ██████ came out the front door numerous times and pointed the rifle at them and this was when ██████ would hear a clicking noise. ██████ did not know what ██████ was clicking but stated that the rifle was semi-automatic. ██████ was not worried at this point about ██████ shooting at them because ██████ believed ██████ had not found the ammunition.

After some time had passed, ██████ left Deputy Berry and Officer Landreneaux at the patrol unit, went to ██████ residence, and met with him. ██████ said that Deputy Berry and Officer Landreneaux asked him to tell ██████ to secure his residence. After leaving ██████ residence ██████ said he was so ill from a spider bite that he slept for several hours along the side of the road near the location of the patrol unit. ██████ said that once he began hearing the gunshots he returned to ██████ residence and called ██████ to come and get him. ██████ said he walked out onto Bloody Camp Rd. and met with ██████ This concluded my interview with ██████

After speaking with ██████ I met with Lieutenant Cavinta in the Command Post. Lieutenant Cavinta advised me that the Eureka Police Department's SWAT team was en route to our location and was going to relieve Sheriff's Office SET team members when they arrived. The Sheriff's Office SET team members were going to attempt to get some rest while the Eureka Police Department SWAT team secured the area.

On 6/4/07 at about 0322 hrs, I met with Humboldt County Sheriff's Deputy Jason Daniels at the intersection of the driveway to the residence and Bloody Camp Rd. I was aware that Deputy Daniels had been attempting negotiations with ██████ ██████ I asked Deputy Daniels if I could speak to him regarding his attendance at negotiations and what he had observed. Deputy Daniels agreed to speak with me and I interviewed him in my vehicle. The interview was digitally recorded and later placed onto CD. The following is a brief summary of that interview. Refer to the CD or transcript for further details.

Deputy Daniels told me that he was a hostage negotiator for the Sheriff's Office SET team and had been in this position for just less than one year. Deputy Daniels told me on 6/3/07 at about 1600 hrs, he was telephoned at his home by dispatch. Dispatch advised Deputy Daniels to respond to Bloody Camp Rd. because he was needed as a negotiator. Deputy Daniels left his residence and arrived on scene at about 1825 hrs. Deputy Daniels told me that Sheriff's Office Sergeant Mike Fridley was also on scene and was a negotiator.

Deputy Daniels and Sergeant Fridley met with Lieutenant Cavinta and Lieutenant Cavinta advised Deputy Daniels and Sergeant Fridley to begin attempting to negotiate with ██████ ██████ Deputy Daniels advised me before he and Sergeant Fridley began attempting to negotiate Deputy Daniels was at the intersection of the driveway to the residence and Bloody Camp Rd. Deputy Daniels heard about three gunshots at that time. Deputy Daniels got into Sergeant Fridley's patrol unit and they drove down the driveway.

Deputy Daniels said that there were numerous patrol units parked on the driveway and that he and Sergeant Fridley took up a position at a Tribal Police unit. Deputy Daniels was aware that there was no telephone in the residence [REDACTED] was in. Deputy Daniels said that a throw phone could not be introduced into the residence because [REDACTED] was an "active shooter". Deputy Daniels and Sergeant Fridley decided to use a public address system on the patrol unit they were positioned at.

Deputy Daniels said that he and Sergeant Fridley began using the public address system at about 1903 hrs. Deputy Daniels said that Sergeant Fridley started the negotiations while Deputy Daniels assisted. Deputy Daniels advised me that due to the situation with [REDACTED] they could not technically negotiate with him so they had to go into a "surrender phase". Deputy Daniels explained this to me as giving orders to [REDACTED] to come outside peacefully and surrender.

Deputy Daniels said that Sergeant Fridley and he attempted numerous times to try and get [REDACTED] to come out of the residence peacefully but there was no response. Deputy Daniels said that he could hear [REDACTED] yelling inside of the residence but could not make out what [REDACTED] was saying.

Deputy Daniels and Sergeant Fridley would give [REDACTED] commands to come outside unarmed and to surrender. After giving these commands, Deputy Daniels and Sergeant Fridley would wait 10 to 15 seconds for [REDACTED] to respond, which he never did. Deputy Daniels advised me that their attempts to get [REDACTED] to surrender were audio taped by himself and Sergeant Fridley.

Deputy Daniels told me at about 2100 hrs, there were more gunshots fired. Deputy Daniels said there was one distinct round that was fired in the direction of him and the other Deputies and six to eight rounds believed to be returned by the SET team members.

Deputy Daniels told me that he and Sergeant Fridley met with Lieutenant Cavinta and Sergeant Bryan Quenell when it became dark outside. It was determined due to the darkness that the negotiations would be terminated because if [REDACTED] did decide to come outside of the residence it would be too difficult to see him.

Deputy Daniels advised me at this time, Eureka Police Department negotiators were standing by in case [REDACTED] came outside of the residence or wanted to speak to the negotiators. This concluded my interview with Deputy Daniels.

On 6/4/07 at about 0400 hrs, I met with Lieutenant Cavinta at the Command Post and he advised to leave the scene and attempt to get some rest while the Eureka Police Department's SWAT team secured the area. Lieutenant Cavinta said that the Sheriff's Office SET team would be returning to the scene at about 0600 hrs. The SET team members were going to respond to the Hoopa Station for some rest.

After speaking with Lieutenant Cavinta, Detective Quenell, Dispatcher [REDACTED] and I went to Willow Creek and returned to the scene at about 0644 hrs. While en route back to the

scene, I took the mileage from the intersection of Loop Rd. and Pine Creek Rd., which was 6.2 miles to the intersection of Bald Hills Rd. and Bloody Camp Rd. From the intersection of Bald Hills Rd. and Bloody Camp Rd. to the intersection of Bloody Camp Rd. and the driveway to the residence where [REDACTED] was located was [REDACTED]. The GPS of the intersection of the driveway and Bloody Camp Rd. was [REDACTED] and [REDACTED].

On 6/4/07 at about 0745 hrs, I noticed [REDACTED] [REDACTED] [REDACTED] colored sedan parked on Bloody Camp Rd. I needed to ask [REDACTED] several follow-up questions so I walked over to her vehicle and met with her outside of it. The interview I conducted with [REDACTED] was digitally recorded and later placed onto CD. The following is a brief summary of the interview I conducted with [REDACTED]. Refer to the CD or transcript for further details.

I asked [REDACTED] that on 6/3/07, when her son, [REDACTED] [REDACTED] was at her residence if [REDACTED] had threatened her at all. [REDACTED] said that after her son, [REDACTED] [REDACTED] dropped [REDACTED] off at [REDACTED] residence after [REDACTED] had cut up some of [REDACTED] [REDACTED] belongings.

[REDACTED] said that when she first met with [REDACTED] told her that he loved her and he was acting normal. [REDACTED] began asking [REDACTED] for some of his money and [REDACTED] told [REDACTED] that if he needed anything she would go and buy the items for him. [REDACTED] also wanted his money to go and get his guitar and amplifier from a house, which [REDACTED] [REDACTED]. [REDACTED] told [REDACTED] that she would go and get the guitar and amplifier for him.

[REDACTED] said after she told [REDACTED] this, [REDACTED] became loud and belligerent and called [REDACTED] a "fucking bitch". [REDACTED] began telling [REDACTED] to give him his money, [REDACTED] began to "hock up", and [REDACTED] yelled "hey" at [REDACTED]. [REDACTED] said that [REDACTED] was going to spit on her before [REDACTED] [REDACTED] had yelled at [REDACTED].

I asked [REDACTED] if she had a young daughter at her residence. [REDACTED] told me that she was helping her son, [REDACTED] [REDACTED] raise his young daughter [REDACTED] [REDACTED] who was three years old. I asked [REDACTED] what [REDACTED] had mentioned about [REDACTED] while he was at the residence. [REDACTED] said that [REDACTED] did not say anything about her and I asked [REDACTED] if [REDACTED] said that he was going to hurt [REDACTED] in some manner. [REDACTED] said that [REDACTED] did not do this.

[REDACTED] said that she did not know why [REDACTED] was so upset with her but [REDACTED] thought that [REDACTED] might have wanted the money [REDACTED] [REDACTED]. [REDACTED] told [REDACTED] to get into his vehicle and [REDACTED] [REDACTED] drove off with [REDACTED].

[REDACTED] said that she later spoke to Officer Roberts and advised Officer Roberts that [REDACTED] [REDACTED].

I told [REDACTED] that either Deputy Greg Berry or [REDACTED] had told me that [REDACTED] had made a threat toward [REDACTED]. [REDACTED] said that she never heard [REDACTED] make a threat toward [REDACTED]. This concluded my interview with [REDACTED].

On 6/4/07 at about 0745 hrs, I met with Sergeant Wayne Hanson who was now on scene and advised him that I needed to obtain a description of the residence [REDACTED] [REDACTED] had been residing in on Masten Flat in Hoopa. I requested Sergeant Hanson contact Humboldt County Sheriff's Office Detective Ben Nord in his office and provide Detective Nord with the description of the residence for a search warrant.

I telephoned Detective Nord in his office and provided him the information that I had obtained for a search warrant for [REDACTED] [REDACTED] and [REDACTED] residence. I advised Detective Nord that Sergeant Hanson would be telephoning him with a description of [REDACTED] residence.

At about 0820 hrs, I met with [REDACTED] [REDACTED] at her vehicle and asked her if she could meet with Sergeant Hanson and Humboldt County Sheriff's Office Detective Marvin Kirkpatrick at the Hoopa Station. I asked [REDACTED] if she could take Sergeant Hanson and Detective Kirkpatrick to [REDACTED] residence on Masten Flat. [REDACTED] agreed to assist Sergeant Hanson and Detective Kirkpatrick.

I telephoned Sergeant Hanson and Detective Kirkpatrick via cellular phone and advised them that [REDACTED] would be meeting with them at the Hoopa Station. I also asked them to attempt to obtain a statement from [REDACTED] brother, [REDACTED] [REDACTED] [REDACTED].

At about 0900 hrs, I telephoned (Evidence Technician) ET [REDACTED] ET [REDACTED] advised me that she was en route to my location.

At about 1001 hrs, Sergeant Mike Fridley began attempting negotiations with [REDACTED] [REDACTED]. At about 1005 hrs, I met with the assigned CIRT team members in the Command Post. At this time, I wrote out a list of persons that needed to be interviewed. The CIRT team was comprised of Detective Quenell, Sergeant Hanson, Detective Kirkpatrick, District Attorney's Office Investigators Mike Hislop and Steve Dunn. I assigned out assignments to the listed CIRT team members. Investigator Hislop advised me that he was assigning Investigator Dunn to me as the secondary investigator.

On 6/4/07 at about 1112 hrs, I met with Lieutenant Cavinta in the Command Post. Lieutenant Cavinta advised me that the Humboldt County Sheriff's Office SET team and the Eureka Police Department's SWAT team had a perimeter around the house that [REDACTED] [REDACTED] had barricaded himself in. **Lieutenant Cavinta told me that in several minutes he was going to give the order to introduce chemical agents into the residence by the SET team and Eureka Police Department's SWAT team.**

At about 1139 hrs, ET [REDACTED] arrived on scene and I briefed her on the situation and where evidence could possibly be located. I also advised ET [REDACTED] that I was waiting for Detective Nord to complete a search warrant for [REDACTED] [REDACTED] residence on Masten

DO NOT DUPLICATE
THIS DOCUMENT CONTAINS
RESTRICTED INFORMATION
DISTRIBUTION OF THIS INFORMATION IS PROHIBITED
HUMBOLDT COUNTY SHERIFF

Flat. I was going to have ET [REDACTED] Sergeant Hanson and Detective Kirkpatrick go to [REDACTED] residence once a judge signed the search warrant.

At about 1213 hrs, I was standing outside of the Command Post when Lieutenant Cavinta met with me and advised me that he had just received a telephone call from Detective Nord telling him that the search warrant for [REDACTED] residence and [REDACTED] and [REDACTED] residence had been signed. I immediately telephoned Detective Nord via cellular phone and he advised me that Superior Court Judge Cissna had signed the warrant at 1210 hrs. Detective Nord said that he also prepared a Ramey Warrant for [REDACTED] arrest for attempted murder, which was also signed by Judge Cissna. Detective Nord was going to fax a copy of the Ramey Warrant to the Hoopa Station.

On 6/4/07 at about 1323 hrs, I spoke to Chief Hostler. Chief Hostler told me that he had received information that [REDACTED] [REDACTED] had C-4 explosives and a tunnel under his residence. I immediately telephoned [REDACTED] and [REDACTED] cellular phone and spoke with [REDACTED] told me that [REDACTED] was not with her at this time and she would have [REDACTED] contact me when he returned.

At about 1331 hrs, ET [REDACTED] met with me outside of the Command Post and advised me that she was en route to [REDACTED] residence on Masten Flat to serve the search warrant on [REDACTED] residence. Detective Kirkpatrick and Sergeant Hanson were also en route to assist ET [REDACTED]

At about 1415 hrs, [REDACTED] [REDACTED] telephoned me on my cellular phone. [REDACTED] told me that there was no C-4 in his residence and there was no tunnel under his residence. By the time I had spoken to [REDACTED] I had also received information that one of the tactical teams had seen a revolver inside of the residence. I asked [REDACTED] about this revolver and [REDACTED] told me that he did not own a revolver the only handgun that [REDACTED] had was the 45 caliber semi-automatic handgun. [REDACTED] added that he had been hearing through the community that [REDACTED] [REDACTED]

At about 1509 hrs, I was now in the Command Post and I could hear radio traffic from one of the tactical team members that stated that rounds from inside of the residence were "cooking off" or shots were being fired from within the residence. At about 1519 hrs, there was further radio traffic that flames were seeing inside of the residence.

At about 1530 hrs, Lieutenant Dave Morey radioed the Command Post and advised that if fire personnel were going to respond to the residence the patrol units that had been shot would have to be moved. Lieutenant Morey was advised that if the units were to be moved to attempt to mark the locations of tires to the patrol units.

At about 1540 hrs, I walked ET [REDACTED] to the location where the two Tribal patrol units had been parked so she could begin taking photographs. Lieutenant Morey advised me that he had marked where the Tribal patrol units and the Sheriff's Office patrol unit had been parked. Lieutenant Morey utilized yellow spray paint to mark the tires. I also met

with Sergeant Phil Buihner who advised me that he had marked the Tribal patrol units' tires that were Ford Explorers with pink spray paint.

I noticed at this point that the south side of the residence [REDACTED] [REDACTED] was in was now fully engulfed in flames. ET [REDACTED] provided her camera to Deputy Blake Massaro to photograph the area around the residence. ET [REDACTED] also provided a video camera to Sergeant Quenell so he could videotape the area around the residence.

At about 1551 hrs, fire personnel from the Hoopa Volunteer Fire Department arrived on scene and began extinguishing the fire.

At about 1616 hrs, fire personnel were still putting out several hotspots on the residence. Lieutenant Cavinta called me over to the west side of the residence and advised me that the fire personnel had cut a hole in the west side of the residence. After the whole was cut, a male body, believed to be that of [REDACTED] [REDACTED] was located lying on the bathroom floor. ET [REDACTED] and I walked up to this hole and ET [REDACTED] photographed the body.

[REDACTED] was unclad and lying on his right side, and was in a semi-fetal position. [REDACTED] head was pointing east toward the bathroom door and his feet were pointing west toward the wall or what appeared to be the shower of the bathroom. [REDACTED] had what appeared to be soot on the top exposed portions of his skin.

The bathroom door was shut and there was a towel placed at the bottom of the door between the opening of the door and the floor. On the top of the filler bowl to the toilet was what appeared to be a semiautomatic handgun. I also noticed that there was water dripping from the top portion of where the fire personnel had cut the hole in the side of the residence. This area of the bathroom appeared to be the shower to the bathroom. I was unable to tell if the water coming from this area was from the fire personnel extinguishing the fire or the shower had been turned on at one time.

At about 1622 hrs, I met with Lieutenant Cavinta and he advised me that he had spoken to DOJ (Department of Justice) Chief Criminalist [REDACTED] who worked out of the Eureka office. Criminalist [REDACTED] advised Lieutenant Cavinta that Criminalist [REDACTED] had some expertise in fire investigations. Criminalist [REDACTED] said that he would have Criminalist [REDACTED] contact me via cellular phone.

Due to the length of time that all of the personnel involved with the standoff with [REDACTED] [REDACTED] and the plans to continue to process the scene for evidence the next day. Lieutenant Cavinta and I discussed the removal of [REDACTED] [REDACTED]. Lieutenant Cavinta advised me that he wanted the Coroner's Office notified and [REDACTED] body removed from the residence on this day.

At about 1655 hrs, I met with Detective Quenell, Investigator Hislop and District Attorney's Office Investigator Bill Honsal. I advised them to respond to the Hoopa Station and meet with SET members. I advised them that I had already spoken to Sergeant Quenell and he was going to advise the SET team members to respond to the

Hoopla Station. While at the Station they were to inspect the SET members' weapons and perform a round count. I also advised them that ET [REDACTED] would be en route to the Station to take photographs.

I next spoke with Sergeant Hanson and he advised me that he would get in touch with the Humboldt County Arson Task Force to set up a time for them to process the residence.

At about 1657 hrs, I met with Detective Kirkpatrick and he advised me that he had spoken to Deputy Coroner Charlie Van Buskirk at about 1653 hrs. Deputy Van Buskirk advised Detective Kirkpatrick that he would be en route to the scene.

At about 1701 hrs, Sergeant Hanson advised me that he had spoken to Humboldt County Sheriff's Office Deputy Dave Diemer of the Arson Task Force. Deputy Diemer advised Sergeant Hanson that the Arson Task Force would be at the residence on 6/5/07 at about 0800 hrs.

After speaking with Sergeant Hanson, I met with the fire personnel and requested that they widen the hole that they had previously cut where [REDACTED] was revealed. I was requesting this because it would assist in taking photographs and the removal of [REDACTED]

At about 1705 hrs, I spoke to Criminalist [REDACTED] via cellular phone. Criminalist [REDACTED] advised me that he did not believe his response was necessary. Criminalist [REDACTED] said that his expertise was in testing for accelerants not for cause and origin. I told Criminalist [REDACTED] that he did not need to respond.

After speaking with Criminalist [REDACTED], I met with Detective Kirkpatrick and Eureka Police Department Detective Kevin Lawson they advised me that they would respond back to the residence on 6/5/07 at 0800 hrs, to assist ET [REDACTED] and the Arson Task Force with the processing of the residence. Sergeant Hanson also advised me that at least he and Sergeant Buihner would stay the night at the scene so it remained secure.

On 6/4/07 at about 1745 hrs, I returned to the Command Post and met with Detective Quenell. Detective Quenell advised me that the SET team members' weapons were examined and rounds counted at the driveway. ET [REDACTED] had also photographed the SET team members at this location. I asked Detective Quenell why this was and Detective Quenell told me that Investigator Hislop had made the decision to have the weapons checked and the photographs taken at the driveway to the residence.

I met with the CIRT members that were not going to respond to Bloody Camp Rd. on 6/5/07 and advised these CIRT members to meet with me on 6/5/07 at 0800 hrs, at CID in the Sheriff's Office. On 6/4/07 at about 1815 hrs, I left the scene along with the other personnel that was not designated to stay and secure the residence.

It should be noted that after I left the scene, the Deputies that had discharged their weapons were transported to St. Joseph's Hospital for blood draws refer to Investigator Hislop's report for further details.

On 6/5/07 at about 0800 hrs, I met with the following CIRT team members in CID. Investigator Dunn, Investigator Honsal, District Attorney's Office Investigator Wayne Cox, Arcata Police Department Sergeant Bart Silvers, Fortuna Police Department Officer Matt Eberhardt and Detective Quenell. I made out assignments for follow-up interviews to be conducted by the above CIRT team members. Investigators Hislop and Cox were going to respond back to the scene to prepare a diagram utilizing a "Total Station".

At about 0945 hrs, the briefing with the CIRT team members concluded. Investigator Dunn was going to begin to contact Deputies and Officers that were involved in the incident on Bloody Camp Rd. Investigator Dunn was going to arrange to meet with the Deputies and Officers that we were assigned to interview.

On 6/5/07 at about 1443 hrs, Investigator Dunn and I met with Lieutenant Dave Morey in his office at the McKinleyville Station. Lieutenant Morey was one of the negotiators present during the incident with [REDACTED] [REDACTED]. The interview we conducted with Lieutenant Morey was digitally recorded and later placed onto CD. Refer to Investigator Dunn's report for further details regarding this interview.

On 6/5/07 at about 1526 hrs, Investigator Dunn and I met with Lieutenant Steve Knight in his office at the Humboldt County Sheriff's Office Animal Control Shelter. Lieutenant Knight was present on Bloody Camp Rd. on 6/3/07. The interview with Lieutenant Knight was digitally recorded and later placed onto CD. Refer to Investigator Dunn's report for further details regarding this interview.

On 6/5/07 at about 1824 hrs, Investigator Dunn and I met with Eureka Police Department Sergeant Bill Nova in an interview room at the Eureka Police Department. Sergeant Nova was the commander of the Eureka Police Department's SWAT team. The interview conducted with Sergeant Nova was digitally recorded and later placed onto CD. The following is a brief summary of the interview conducted with Sergeant Nova. Refer to the CD or transcript for further details.

Sergeant Nova had been employed by the Eureka Police Department for the past 21 years. Sergeant Nova added that he had been on the Eureka Police Department's SWAT team for the past 18 to 19 years.

I asked a Sergeant Nova to explain to me what had occurred on 6/3/07. Sergeant Nova told me that on the above date he received a page through his dispatch at about 1951 hrs. The page asked Sergeant Nova to contact Lieutenant Knight on his cellular phone. Sergeant Nova telephone Lieutenant Knight and ended up speaking to Lieutenant Cavinta who was in charge of the SWAT operation. Lieutenant Cavinta told Sergeant Nova that his SET team was located above the Hoopa area and it appeared to Lieutenant Cavinta that his team was going to have to spend the night. Lieutenant Cavinta requested mutual aid from Sergeant Nova because Lieutenant Cavinta's team had already been on scene for numerous hours.

Sergeant Nova said that he advised Lieutenant Cavinta that he would have to go up his chain of command to make sure that his team could respond and he would re-contact Lieutenant Cavinta. Sergeant Nova said that he got authorization and he contacted his dispatch to put a page out to the SWAT team members and the negotiation team.

Sergeant Nova contacted Lieutenant Cavinta and advised him that his team along with negotiators would be responding. Lieutenant Cavinta requested that Sergeant Nova have his team on scene by 0200 to 0300 hours on 6/4/07.

Sergeant Nova said that on 6/4/07 at about 0030 hrs, the SWAT team and the Crisis Negotiation Team all met at the Eureka Police Department. Sergeant Nova briefed the SWAT team and the negotiation team on the information that he had received from Lieutenant Cavinta. After the briefing concluded, the two teams responded to Bloody Camp Rd.

Sergeant Nova said that they arrived on scene at about 0215 hrs, Sergeant Nova's team prepared themselves and while they were doing this, Sergeant Nova went to the Command Post and met with Lieutenant Cavinta. Lieutenant Cavinta briefed Sergeant Nova on the locations of his team members. Sergeant Nova said that he met with his team and divided his team up into several different teams. At that point, Sergeant Nova inserted his team members into the perimeter to relieve the Sheriff's Office SET team members. Sergeant Nova believed by 0300 to 0400 hours, his SWAT team had completely relieved the SET team of their positions.

Sergeant Nova explained to me where he had positioned his team members. We provided a sketch of the area to Sergeant Nova and he showed us where his teams were positioned. The sketch was later attached to this case.

Sergeant Nova had most of his team members positioned on the number four side of the residence near the Tribal Police patrol units that were parked on the driveway to the residence. Sergeant Nova said that the other team had positioned themselves on the west side of the residence, which he referred to as the number one side. Sergeant Nova said that he had a third team positioned on the number three side of the residence, which would have been on the east side of the residence.

Sergeant Nova said that Lieutenant Cavinta gave their rules of engagement with [REDACTED] and it was a no fire situation unless [REDACTED] had presented himself as an immediate threat.

I asked a Sergeant Nova while his SWAT team was in position if his negotiators attempted to speak with [REDACTED] Sergeant Nova said that he did not have his negotiators attempt to contact [REDACTED]

I asked Sergeant Nova once his teams took the positions over from the SET team if he assumed command over the operation. Sergeant Nova said he did but Lieutenant Cavinta stayed on scene in the Command Post.

I asked Sergeant Nova during the time that he and his team were securing the residence if anything occurred with [REDACTED]. Sergeant Nova said that his team could see into the residence and could see [REDACTED] moving about the interior of the residence.

Sergeant Nova said at about 0455 hrs, it began to get lighter outside and the team that was positioned on the west side of the residence moved the Tribal Police patrol unit about 60 to 80 yards farther away from the residence up the driveway that led to [REDACTED] residence. Sergeant Nova said that Detective Ron Harpham and Officer Gary Cooper were the team members that were in this location.

Sergeant Nova said at about 0509 hrs, [REDACTED] had turned all of the lights in the residence off, which had been on the entire time that Sergeant Nova had his teams in their positions. Sergeant Nova said that once [REDACTED] turned off the lights they did not see him moving about the residence any further. The team members no longer could hear [REDACTED] moving about the residence after this occurred.

Sergeant Nova said at about 0730 hrs, the Sheriff's Office SET team members had arrived back on scene. The SET team members began inserting into the positions where Sergeant Nova had positioned his team members and the SET team members relieved Sergeant Nova's teams who met back at the Command Post. Sergeant Nova said that at this point Lieutenant Cavinta took back command of the operation.

Sergeant Nova said on 6/4/07 at about 1001 hrs, his SWAT team went back operational joining the SET team. Sergeant Nova said that he had sent his entire team at this point to the location of the two Tribal Police patrol units that were parked on the driveway. Sergeant Nova was also aware from speaking with Lieutenant Cavinta that if attempts to negotiate with [REDACTED] were once again unsuccessful chemical agents were going to be introduced into the residence.

Sergeant Nova said that he and Lieutenant Cavinta discussed options of how they were going to proceed tactically. They also discussed again attempting to contact [REDACTED] through the negotiation teams that were present. Sergeant Nova and Lieutenant Cavinta decided to have the negotiation teams attempt to contact [REDACTED] for the next two hours and if that was unsuccessful, they would begin the implementation of chemical agents.

Sergeant Nova recalled that at about 0900 hrs, he had released his negotiation team and Lieutenant Cavinta had requested a negotiation team from CDC (California Department of Corrections) out of Pelican Bay State Prison out of Crescent City, Ca. Sergeant Nova and Lieutenant Cavinta had discussed the utilization of a "throw phone" being introduced into the residence. Both Sergeant Nova and Lieutenant Cavinta felt that this would be impossible to introduce into the residence due to [REDACTED] already shooting at the Officers that were on scene earlier. Sergeant Nova added that CDC had several of their tactical response team members respond to the scene with the CDC negotiators.

Sergeant Nova and Lieutenant Cavinta decided to have Sergeant Mike Fridley attempt to contact [REDACTED] through the public address system on one of the patrol units that was parked on the driveway. Sergeant Fridley began giving [REDACTED] surrender orders and sounding the siren from one of the patrol units. Sergeant Nova said that this went on for sometime and as far as Sergeant Nova knew there was never any contact between [REDACTED] and any of the negotiators.

Sergeant Nova said that he and Lieutenant Cavinta also discussed making arrangements through CHP or the Coast Guard to have a helicopter on standby if needed for medical assistance. Sergeant Nova said that CHP was unable to assist due to weather and the Coast Guard advised them that if medical assistance was needed that they would respond.

Sergeant Nova said at about 1001 hrs, he sent his team back into the perimeter with the SET team to reinforce the perimeter. Sergeant Nova said at this point, Officer's Tim Jones and Louis Altic, who were assigned to the SWAT team as chemical agent deplorers, gathered the SWAT teams' chemical agents and brought them with them to the perimeter. Sergeant Nova said that his SWAT team had no pyrotechnic chemical agents. Sergeant Nova said that Officers Jones and Altic brought with them two 37 mm gas launchers and had no chemical agents that were hand thrown. Sergeant Nova said that these Officers also took shotgun rounds with them, which were CS chemical agent rounds.

I asked Sergeant Nova before Officers Jones and Altic left the Command Post if he and Lieutenant Cavinta discussed introducing chemical agents into the residence. Sergeant Nova said that they did and that if it came to introducing the chemical agents that they would be dispersed into the windows on the number four side of the residence. Sergeant Nova said that the reason the chemical agents would be deployed on this side was that this was the shortest distance to the residence. Sergeant Nova explained that the farther away from the residence that the chemical agents were dispersed the less effective they would be.

As time went on and no contact had been made with [REDACTED] Sergeant Nova said that Lieutenant Cavinta decided to introduce chemical agents into the residence. Sergeant Nova said at about 1114 hrs, SET team members began introducing chemical agents into the number four side of the residence.

Sergeant Nova said that he was in the Command Post and at about 1119 hrs, Sergeant Quenell radioed the Command Post and stated that 10 rounds of 37 mm munitions had been shot through the windows on the number four side. Sergeant Nova said that five rounds had been put into each window. Sergeant Nova said that the 37 mm rounds were shot into the residence from the number one location, which was where the original Tribal Police units were parked on the driveway.

At about 1126 hrs, Sergeant Quenell radioed the Command Post and advised that his team had shot a second volley of ten 37 mm rounds into the windows. Sergeant Quenell radioed that there was no movement from within the residence.

At about 1135 hrs, Lieutenant Cavinta advised over the radio to have chemical agents introduced into the number two side of the residence. Sergeant Nova said that his entire SWAT team was on the number three side of the residence so he had his team move to the number two side of the residence. Sergeant Nova said that on the number two side of the residence it was believed this was the location of the master bedroom.

Sergeant Nova said while his team was getting into position on the number two side of the residence, at about 1140 hrs, Sergeant Cavinta radioed and had Sergeant Fridley get on the public address system and put out another surrender order to [REDACTED]

When Sergeant Nova's team arrived on the number two side of the residence, Officers Jones and Altic were armed with single shot 37 mm launchers, and they began to introduce chemical agent munitions through this side of the residence. Sergeant Nova said that he believed that five 37 mm munitions were introduced into the residence at this time. Officers Jones and Altic introduced the chemical agents from 1203 to 1206 hrs. Sergeant Nova believed that ten 37 mm munitions were delivered into the number two side of the residence. From what Sergeant Nova understood, five rounds made it into the residence and five did not.

Sergeant Nova added that his team advised him that they had used a laser rangefinder and it was 84 yards from where they shot the 37 mm munitions. Due to this distance, Officers Jones and Altic were unsure if any of the munitions had made it into the residence. Sergeant Nova said that there was some radio traffic that there was some movement within the master bedroom.

I asked Sergeant Nova what type of munitions the 37 mm rounds were. Sergeant Nova said that they were CS, heavy barricade penetrating rounds.

Lieutenant Cavinta radioed Sergeant Quenell and advised him that after EPD's SWAT team concluded with their volley into the number two side to have the SET team introduce another volley into the number four side of the residence.

Sergeant Nova said that after the SET team completed their volley Sergeant Fridley began giving surrender orders once again.

I asked Sergeant Nova from the amount of chemical agents that had actually gotten into the residence if the chemical agents would have saturated the residence. Sergeant Nova said that it would have if the residence would have been sealed but due to the wind and the broken out windows the wind would have been blowing the chemical agents out of the residence. Sergeant Nova said that if [REDACTED] was able to seal himself into a room that the chemical agents would have had a minimal effect on him.

Sergeant Nova said that sometime around noon, he and Lieutenant Cavinta began discussing the deployment of chemical agents on the number three side of the residence.

The reason they were discussing this was because of how the wind was blowing through the residence.

Sergeant Nova said at this point, he split up his team and had Officer's Wilcox, Hill, Jones and Altic move to the number three side of the residence. Sergeant Nova said that at about 1258 hrs, Officer Wilcox radioed the Command Post and stated that the team was about five minutes away from a location on the number three side of the residence to deploy the chemical agents. Sergeant Nova said that he was communicating with his team on the number three side and Lieutenant Cavinta was communicating with his team that was on the number four side of the residence. Sergeant Nova and Lieutenant Cavinta planned on Sergeant Nova's team deploying 37 mm munitions into the number three side and Lieutenant Cavinta's team was going to deploy shotgun ferret rounds into the number four side.

At about 1309 hrs, Officer Jones radioed the Command Post that chemical agents were now being deployed into the number three side of the residence. At about 1311 hrs, Sergeant Quenell radioed the Command Post and advised that the ferret rounds had now ported the windows on the number four side. Also, at this same time, Officer Jones radioed the Command Post and advised that he believed four 37 mm munitions entered the number three side of the residence. Sergeant Nova said that he could not recall how many 37 mm munitions were deployed in total on the number three side of the residence but believed that his team had deployed five munitions at the number three side.

At about 1317 hrs, Lieutenant Cavinta had moved his team that was positioned at the Tribal Police units up to the number four side and this team deployed two handheld chemical agents into the windows. Sergeant Quenell notified the Command Post when he returned to the patrol units that a large possibly nickel-plated revolver was seen in the residence.

I asked Sergeant Nova if he knew what type of handheld chemical agent was thrown through the windows. Sergeant Nova said if it was anything like what his SWAT team utilized it would be a CS gas, which was a non-pyrotechnic. The canister would spray a CS gas throughout the room it was placed in.

Sergeant Nova said that after the SET team deployed the handheld chemical agents. The same team returned to the number four side and deployed two handheld CS smoke grenades and a sting ball into the two windows at about 1421 hrs. Sergeant Nova said that the SET team was given the CS smoke grenades by CDC's tactical team. Sergeant Nova said that the Command Post checked with the teams that were out on the perimeter for any noise or movement they could hear or see coming from the residence and the teams responded that neither was present.

Sergeant Nova said that he and Lieutenant Cavinta left the Command Post and walked up to the Tribal Police units that were parked on the driveway on the number four side of the residence. At about 1436 hrs, Sergeant Nova said that he noticed smoke coming from within the residence. Sergeant Nova said that the smoke appeared to be coming from the

number four side of the residence from the "A" window, which would have been the window to the left on the number four side. Sergeant Nova said that he radioed the Command Post to have the fire personnel that were on scene put on standby. Sergeant Nova also advised the Command Post that surrender orders were going to start to be given, which were given by Sergeant Fridley.

I asked Sergeant Nova if the smoke was from the canisters that were deployed into the residence and he said that it was not. The smoke that comes from the canisters would be a white color and the smoke he observed was dark gray in color. Sergeant Nova said at about 1450 hrs, he noticed that smoke was now coming out of both windows on number four side of the residence.

At about 1503 hrs, Sergeant Nova heard radio traffic from CDC's tactical team stating that smoke was now coming out of the number three side window. At this same point, Sergeant Nova said that he heard either firearm rounds being shot or "cooking off" in the residence. Sergeant Nova said that about 1509 hrs, smoke was now billowing out of the roof of the residence and he could see a small amount of flames within the residence.

At about 1515 hrs, Sergeant Nova said that on the number four side of the residence there were visible flames. At about 1524 hrs, Sergeant Nova said that the fire personnel were escorted up to the point where the Tribal Police patrol units were parked on the driveway to the residence. At about 1548 hrs, Sergeant Nova said from what he could see the house was fully engulfed in flames and fire personnel was escorted into area of the residence to extinguish the fire. Sergeant Nova said at about 1603 hrs, he radioed his SWAT team members and advised them to return to the Command Post.

I asked Sergeant Nova what was the rank structure for this incident. Sergeant Nova said that Lieutenant Cavinta was the incident commander and that he and Lieutenant Cavinta would speak to one another on decisions that were made during the incident. Sergeant Nova said that he did speak to his Lieutenant and Chief to keep them up to date on what was occurring. Sergeant Nova added that he also knew that Lieutenant Cavinta had made telephone calls to Undersheriff Downey updating him on the incident.

Sergeant Nova added that it was a mutual decision between him and Lieutenant Cavinta that their teams would not enter the residence [REDACTED] was in unless he surrendered.

I asked Sergeant Nova about the log that he had been referring to during our interview. Sergeant Nova said that the log was prepared by his Tactical Dispatcher [REDACTED] and that he would provide a copy of it to Investigator Dunn and I. I later attached this log to this case.

I asked Sergeant Nova how involved in the incident was CDC's tactical team. Sergeant Nova said that CDC had a first tactical team that arrived to assist in the morning and later on in the day, a second team arrived. Sergeant Nova said that he could not recall any of CDC's tactical team ever been deployed to the perimeter with the Police Department's or

Sheriff's Office's teams. Sergeant Nova said that for the most part the CDC teams maintained security around the Command Post.

I asked Sergeant Nova if he could explain to me the difference between pyrotechnic and non-pyrotechnic chemical agents. Sergeant Nova said that most if not all of his SWAT teams chemical agents were purchased from Def-Tech, which stood for Defense Technology. Sergeant Nova said that non-pyrotechnic chemical agents could be deployed into a pile of sawdust and it would not ignite the sawdust. A pyrotechnic canister could heat up as it was deploying whatever type of agent it was deploying and could cause a fire if deployed inside of a structure. Sergeant Nova said that the only type of chemical agents his team utilized in this incident were non-pyrotechnic. As far as the SET team, Sergeant Nova believed that only non-pyrotechnics were utilized by them when deploying the chemical agents. Sergeant Nova said that the advantage to using a pyrotechnic would be that when the chemical agents were heated up it would atomize the chemical agents causing it to stay in the air longer.

I asked Sergeant Nova if he and Lieutenant Cavinta ever discussed using pyrotechnics in the residence. Sergeant Nova said that they had discussed the use of pyrotechnics but decided against using them.

I asked Sergeant Nova based on his own opinion how he thought the fire started inside of the residence. Sergeant Nova said initially that he thought that [REDACTED] had set the house on fire but felt that there was an outside chance that one of the handheld chemical agents could have started the fire. Sergeant Nova felt this could have been the cause of the fire because the canisters do get warm to the touch. Sergeant Nova added that there was a chance if one of the canisters landed on something that was flammable the canister's warmth and the wind blowing through the residence could have possibly started the fire.

I asked Sergeant Nova if he felt that there was anything else they could have done or given [REDACTED] [REDACTED] anymore of an opportunity to come out of the residence. Sergeant Nova answered, "No, not at all."

Sergeant Nova said that from the intelligence, that he had [REDACTED] was armed with a 22 caliber rifle and had at least 50 to 100 rounds in his position and that was even if [REDACTED] was unable to get into the gun safe that was in the residence. Sergeant Nova added that he was not going to have his team enter the residence or even get too close to it. Sergeant Nova said that the only other option he could think of to get a team close to the residence was an armored vehicle, which his team or the SET team did not have.

Sergeant Nova said that before the fire started Lieutenant Cavinta had actually placed a call with FBI out of San Francisco, Ca. Lieutenant Cavinta requested that FBI SWAT respond to the scene the following day with their two armored vehicles. Sergeant Nova said that Lieutenant Cavinta said that at 1700 hrs, Eureka Police Department's SWAT team and the Sheriff's Office SET teams were going to be removed from the perimeter so that the team members could get some sleep. The CDC tactical teams were going to move into the perimeter and secure it until Eureka Police Department SWAT team and

the Sheriff's Office SET team returned. Sergeant Nova said hopefully by the time these teams returned at 0700 hrs the next day the FBI SWAT team would be on scene with the armored vehicles and further resources.

I asked Sergeant Nova in the 19 years that he had been a SWAT team member if he had ever been on a mission when chemical agents had been deployed into a residence and the person that was barricaded had not come out of the residence. Sergeant Nova said that in his experiences as a SWAT team member this had occurred and was not that uncommon.

Investigator Dunn asked Sergeant Nova what the difference was between a Eureka Police Department SWAT team member and a tactical rifleman. Sergeant Nova said that the SWAT team members go through training and were certified. Sergeant Nova said that he used riflemen to contain the inner perimeter and that they were not certified through POST (Peace Officers Standards and Training).

Investigator Dunn asked Sergeant Nova about his SWAT teams' grenadiers or gasmen who were Officers Jones and Altic. Sergeant Nova said that he actually had three SWAT team members that were certified through training as grenadiers but only Officers Jones and Altic were on scene.

Sergeant Nova added that he and Lieutenant Cavinta had decided together at no time were they going to send either of their teams into the residence due to [REDACTED] shooting at the Officers. Even when the fire started neither Sergeant Nova nor Lieutenant Cavinta were going to send either of their teams into the residence because doing so would be unsafe. This concluded our interview with Sergeant Nova.

On 6/6/07 at about 0937 hours, Investigator Dunn and I met with Eureka Police Department Officer Tim Jones at the Eureka Police Department. We interviewed Officer Jones in the SWAT team office at the Police Department. The interview was digitally recorded and later placed onto CD. The following is a brief summary of the interview. Refer to the CD or transcript for further details.

Officer Jones said that he had been in law enforcement for the past 11 years. The last 8 1/2 years he had been with the Eureka Police Department. Officer Jones was currently assigned as an FTO and had been a member of the SWAT team for almost 5 years. Officer Jones' positions on the SWAT team included entry, chemical agents deployment and sniper trainer.

I asked Officer Jones on 6/3/07, how he was notified of what was occurring in Hoopa. Officer Jones said sometime between the hours of 2015 and 2030 hrs, he received a page from his dispatch that advised him to telephone Sergeant Nova at his residence in regards to an agency assist SWAT callout. Officer Jones telephoned Sergeant Nova and Sergeant Nova advised Officer Jones that the Sheriff's Office was requesting their assistance and that shots had already been fired. Sergeant Nova told Officer Jones that they were going to meet at the Eureka Police Department and attempt to arrive on scene on 6/4/07 at about

0030 hrs. Officer Jones said that he responded to the Police Department and drove with the rest of the team to the scene.

Officer Jones said once arriving on scene the SWAT team was briefed. Officer Jones said the SWAT team was split into two teams and responded to the perimeter and relieved the Sheriff's Office SET team members.

I asked Officer Jones where he and his team members responded. I provided Officer Jones with one of the sketches of the scene that had been prepared. Officer Jones believed that he, Officers Wilcox, Hill and Sergeant Nova responded to the Tribal Police units that were parked on the number four side of the residence. Officer Jones believed that he and other members of his team took over positions from the SET team at about 0300 hrs. Officer Jones said at first he was armed with his assault rifle but later returned and gathered his 308 rifle, which had a scope on it so Officer Jones could see the residence from a distance.

Officer Jones said that he and the other Officers stayed at this location until the sun began to rise. Officer Jones and the other Officers on his team said at this time they moved back away from the two Tribal Police patrol units to two other patrol units that were parked behind these units. Officer Jones said that he did this because they felt it was safer since [REDACTED] had already shot at these two patrol units. Officer Jones said when he and the other Officers moved away they could no longer see the number four side of the residence.

I asked Officer Jones during his time stationed at the patrol units what he heard or could see. Officer Jones said that occasionally he could see movement on the number four side in the B window.

Officer Jones said shortly after they moved back to the other patrol units, SET team members came and relieved Officer Jones and the other Officers and they returned to the Command Post. Officer Jones said that after the Police Department's SWAT team rested for about an hour they were advised that chemical agents were going to be introduced into the residence. Officer Jones said that he and Officer Altic were advised to gather their chemical agents because they were going to be deployed out on to the perimeter.

Officer Jones said that he and what he believed to be the entire Police Department's SWAT team responded to the patrol units that were near the Tribal Police patrol units that were parked on the driveway. At this time, Officer Jones said that the SET team began deploying chemical agents into the residence on the number four side. Officer Jones said that while the chemical agents were being deployed someone was on the public address system from one of the patrol units attempting to get [REDACTED] to respond.

Officer Jones said that he and Officer Altic along with the other SWAT team members were sent out to the number two side of the residence to attempt to deploy chemical agents into this side of the residence. Officer Jones said that when they arrived on the number two side of the residence, he utilized a rangefinder and they were 81 yards from

the residence. Officer Jones said that he and Officer Altic were radioed by Sergeant Nova and advised to deploy the chemical agents into the number two side of the residence.

Officer Jones told me that there was only one window on the number two side of the residence, which was fairly close to the center of the outside wall. Officer Jones said that they were advised by Sergeant Nova to put five rounds of chemical agents into this area of the residence. Officer Jones and Officer Altic discussed how they were going to deliver these munitions. They decided that Officer Jones would shoot three rounds and Officer Altic would shoot two rounds. Officer Jones said that he and Officer Altic utilized 37 mm single action launchers to deliver the chemical agents. Officer Jones said when they began delivering the chemical agents he went first and Officer Altic went second and from that point alternated until the five rounds had been deployed.

I asked Officer Jones if they were able to get the chemical agents through the window. Officer Jones said that they were only making about 30% of the munitions through the window. Officer Jones said that the reason for this was that they were operating the launchers outside of the effective ranges. I asked Officer Jones what the effective range of the launchers was and Officer Jones said in his experiences it was within 50 yards.

Officer Jones said after he and Officer Altic deployed the first five rounds Sergeant Nova requested another volley of five rounds into the residence. Officer Jones said that he and Officer Altic delivered five more munitions toward the residence. After this volley was complete, Officer Jones heard further attempts from the public address system to contact

Sergeant Nova again contacted Officer Jones and Officer Altic and advised them to deploy five more rounds, which they did. After this occurred, Officer Jones said that Sergeant Nova had he and Officer Altic deliver two more volleys toward the number two side of the residence. Officer Jones told me in all, he and Officer Altic deployed twenty-one, 37 mm canisters toward the residence or window and Officer Jones believed that seven of the canisters actually made it through the window.

Officer Jones said after this concluded, from what he understood the SET team was either out of 37 mm canisters or were running low. Officer Jones said that they were requested to move to the number three side of the residence and attempt to deploy chemical agents into this side.

Officer Jones said from their position on the number three side he estimated that they were 70 to 75 yards away from the residence. Officer Jones said that they were advised by Sergeant Nova to deploy five 37 mm rounds into the number three side of the residence. Officer Jones said that he covered Officer Altic while he deployed all 5 munitions. Officer Jones said that there were two windows on the number three side of the residence and Officer Altic was able to get two rounds into each window but one of the rounds bounced off the side of the residence. Officer Jones said that once this

concluded that neither he nor Officer Altic deployed any more chemical agents into the residence.

Officer Jones said once again, there was an attempt to contact [REDACTED] through the public address system and there was no response. Officer Jones said the next thing to occur was the SET team who utilized a ballistic blanket approached the number four side of the residence and deployed handheld chemical agents through the windows on the number four side. After the SET team deployed the chemical agents there were once again attempts made to have [REDACTED] surrender but there was no response. Officer Jones said that the SET team returned to the number four side and deployed more handheld chemical agents through the windows. Surrender orders were again given over the public address system.

Officer Jones said that he had heard radio traffic that the SET team was going to deploy a smoke and CS combination handheld into the residence. Officer Jones believed that the SET team did this the second time that they approached the number four side. When the canister was deployed, Officer Jones said he could see a larger amount of smoke on the second deployment from the first deployment. Officer Jones also believed that on the second deployment of the handheld chemical agents a sting ball was deployed.

Officer Jones said that several minutes after the second deployment by the SET team. He noticed black smoke coming from the residence. Officer Jones said that usually a smoke and CS combination canister would produce a white colored smoke. Officer Jones said that the black colored smoke appeared to be coming from the number four side of the residence.

I asked Officer Jones if he heard anything coming from within the residence and Officer Jones said that he could not. I asked Officer Jones if he could hear the surrender orders been given over the public address system and he said that he could hear them clearly.

Officer Jones said that after quite a bit of time past he noticed flames within the residence.

I told Officer Jones when we had met with him earlier that he provided Investigator Dunn and I with a 37 mm barricade-penetrating projectile, which I later placed into evidence at the Sheriff's Office. Officer Jones said that was correct. Officer Jones went on to tell me that when the 37 mm round was fired the casing would stay in the launcher and the projectile would leave the barrel of the launcher. Officer Jones said when the projectile strikes an object the CS gas would be dispersed into the air. I asked Officer Jones if the 37 mm rounds that he and Officer Altic deployed into the residence were made by Def-Tech and he said that they were.

I asked Officer Jones if he could tell me what a sting ball was and Officer Jones said that the Police Department's SWAT team did not have any of these. From Officer Jones' understanding of a sting ball, when it is deployed it shoots out numerous plastic balls, which were used for pain compliance.

I asked Officer Jones while he was on scene on Bloody Camp Rd. if there was any mention about the use of pyrotechnic chemical agents. Officer Jones said that Sergeant Nova had radioed him and asked him if he or Officer Altic had any pyrotechnics with them. Officer Jones advised Sergeant Nova that they did not and Officer Jones said that their SWAT team did not have any pyrotechnic chemical agents with them.

I asked Officer Jones if he knew if any pyrotechnic chemical agents were deployed into the residence. Officer Jones said that he did not believe so and the CS smoke canister that the SET team had introduced into the residence was a canister that produced smoke from a flame that was contained within the canister.

I asked Officer Jones what he believed the effective level was inside of the residence when he and Officer Altic launched the 37 mm rounds into the residence. Officer Jones said that due to the distance that these rounds were fired from he noticed that some of the 37 mm rounds did not even break even after striking the side of the residence. Officer Jones could not really say how many of the munitions broke open that entered the house due to the distance and loss of energy.

Officer Jones told me that there were also ways to defeat the chemical agents once they were dispersed into a residence. He said that one way is to go into a bathroom and fill the bathtub with water and put a wet towel over his/her face and this would act as a filter to protect the person from the chemical agents. Officer Jones added that he had also had an experience with a [REDACTED] that had barricaded himself in a room and hid under a bed with the bed sheets spread over the bed to make a makeshift tent. This person was able to somewhat defeat the effects of the chemical agents by making this tent.

I asked Officer Jones in his own opinion what he believed started the fire at the residence on Bloody Camp Rd. Officer Jones said that he could not really say what caused the fire and that [REDACTED] could have started the fire on his own because he was given plenty of opportunities to surrender.

I asked Officer Jones if he felt [REDACTED] had ample opportunity to come out of the residence and surrender from the time Officer Jones saw the smoke coming from the residence to the time the house was fully engulfed in flames. Officer Jones said that he believed there was plenty of time for [REDACTED] to leave the residence. Officer Jones felt that [REDACTED] would have exited from another portion of the residence other than the front door and Officer Jones was even preparing for [REDACTED] to come out of the residence shooting.

I asked Officer Jones what weapons he was armed with during this incident. Officer Jones said when he got to the number three side of the residence he had exchanged his 308 rifle for his assault rifle, which was an AR-15. Officer Jones also had his department issued handgun on his person.

Investigator Dunn asked Officer Jones how many 37 mm rounds in total were deployed into the number two and number three sides of the residence. Officer Jones said that Officer Altic advised him that it was 26 rounds.

Investigator Dunn asked Officer Jones what type of training he had received in chemical agents. Officer Jones said that he attended a 40 hour class at Napa Valley College in 2000. Officer Jones said that annually the Eureka Police Department SWAT team trained with chemical agents.

I asked Officer Jones if he or Officer Altic picked up any of the 37 mm rounds. Officer Jones said that he believed that Sergeant Johnson picked up a round from the number two side and brought it over to the number three side where they were positioned. This concluded our interview with Officer Jones.

On 6/6/07 at about 1540 hrs, Investigator Dunn and I met with Humboldt County Sheriff's Office Deputy Tony Gomes in the conference room of the Sheriff's Office. The interview we conducted with Deputy Gomes was digitally recorded. Refer to Investigator Dunn's report for details regarding this interview.

On 6/7/07 at about 0925 hrs, Investigator Dunn and I met with Humboldt County Sheriff's Office Deputy Brian Taylor in the conference room of the Sheriff's Office. The interview we conducted with Deputy Taylor was digitally recorded. Refer to Investigator Dunn's report for details regarding this interview.

On 6/7/07 at about 1034 hrs, Investigator Dunn and I met with Humboldt County Sheriff's Office Deputy Jamie Barney in the conference room of the Sheriff's Office. The interview we conducted with Deputy Barney was digitally recorded. Refer to Investigator Dunn's report for further details regarding this interview.

On 6/7/07 at about 1230 hours, Detective Kirkpatrick telephoned me on my cellular phone. Detective Kirkpatrick attended the autopsy of [REDACTED] [REDACTED]. Detective Kirkpatrick advised me that [REDACTED] had no gunshot wounds and the cause of [REDACTED] death was heat and smoke related. Refer to Detective Kirkpatrick's report for further details regarding the autopsy.

On 6/7/07 at about 1304 hrs, Investigator Dunn and I met with Humboldt County Sheriff's Office Sergeant Bryan Quenell in the conference room of the Sheriff's Office. The interview conducted with Sergeant Quenell was digitally recorded. Refer to Investigator Dunn's report for further details regarding this interview.

After speaking with Sergeant Quenell, he walked Investigator Dunn and I to the SET team's trailer, which was located in the Sally Port of the Humboldt County Correctional Facility. Sergeant Quenell turned over to me one CS expulsion grenade and two shotgun ferret rounds. One ferret round contained OC and the other ferret round contained CS. I later placed these items into evidence at the Sheriff's Office.

On 6/8/07 at about 0602 hrs, Investigator Dunn and I met with Eureka Police Department Officer Louis Altic. We interviewed Officer Altic in a conference room within the Police Department. The interview we conducted with Officer Altic was digitally recorded and later placed onto CD. The following is a brief summary of the interview conducted with Officer Altic. Refer to the CD or transcript for further details regarding the interview.

Officer Altic told me that he had been employed by the Eureka Police Department for the past 4 1/2 years. Officer Altic said that he was currently assigned to patrol but was not a member of the Police Department's SWAT team. Officer Altic said that he was a patrol rifleman and the duties of a rifleman were to assist the SWAT team members. Officer Altic said that he had been a patrol rifleman with the Police Department for the past two years.

Officer Altic said that in March or April of 2007 he attended training for deploying chemical agents. The training was given by the Alameda County Sheriff's Office.

I asked Officer Altic how he was notified about the agency assist requests from the Sheriff's Office. Officer Altic said on 6/3/07, he received a page from Sergeant Nova and was telephoned at home by Sergeant Johnson and both requested that Officer Altic respond to the Police Department. Officer Altic said that he responded to the Police Department and met with the other SWAT team members and they were briefed by Sergeant Nova. Sergeant Nova told the SWAT team members that they would be responding to Hoopa to relieve the Sheriff's Office SET team who currently had a perimeter around a residence with a barricaded armed [REDACTED] inside. They were going to relieve the SET team members so they could get some rest.

Officer Altic said that the SWAT team arrived on Bloody Camp Rd. on 6/4/07 between the hours of 0230 and 0300 hrs. Officer Altic said that when they arrived on scene they were met by Lieutenant Cavinta and he briefed the SWAT team further. The Police Department's SWAT team was divided into pairs and Officer Altic's partner was Officer Sanchez.

Officer Altic said that he and Officer Sanchez met with a SET team member who guided them to the position they were to be positioned. At this point, I provided a sketch of the scene to Officer Altic so he could refer to it. I later attached this sketch to this case. Officer Altic said that he and Officer Sanchez went to the number three side of the residence and took over the SET team members' position. Officer Altic said that they stayed in this position throughout the night and when the sun began to rise, they moved farther away from the residence near some trees.

I asked Officer Altic when he arrived at this position if he heard or had seen anything in the residence. Officer Altic said that through the window located near the three and four side corners of the residence Officer Altic saw the male and he was wearing a white T-shirt and as the male stepped away from the window he lit something, which Officer Altic believed to be a cigarette. Officer Altic said that while he and Officer Sanchez

were in this position every once in awhile they would hear movement coming within the residence.

I asked Officer Altic when he first arrived on scene if there were any attempts to negotiate with [REDACTED] [REDACTED] Officer Altic said that there was not.

Officer Altic said, as it got lighter outside two SET team members returned to the number three side of the residence and were slightly in front of Officer Altic and Officer Sanchez. Officer Altic said shortly after this, he and Officer Sanchez were advised via radio to return to the Command Post. Officer Altic said that when he returned to the Command Post he and the other SWAT team members were resting.

Officer Altic said that the SWAT team was at the Command Post for a period of time and during this time; Officer Altic stated that there were surrender orders that were given to [REDACTED] over a public address system. Officer Altic said at no time did he ever hear that [REDACTED] responded back to the negotiators.

Officer Altic said while he was still at the Command Post the SET team began deploying chemical agents into the residence on the number four side. Officer Altic said while this was going on in between munitions being deployed into the residence surrender orders would be given. Officer Altic said after some time had passed, he and Officer Jones were advised to deploy to the number two side of the residence so that they could introduce chemical agents into this side of the residence. Officer Altic said that he and Officer Jones along with the rest of their SWAT team moved to the number two side of the residence. Officer Altic said that they accessed the number two side of the residence by coming off of Bloody Camp Rd.

I asked Officer Altic from this location if he could hear the surrender orders being announced. Officer Altic said that he could clearly hear the orders being given but the orders were not very loud.

Officer Altic said that he and Officer Jones had utilized a rangefinder and the position of the SWAT team from the number two side of the residence was about 81 yards. Eventually, Officer Altic said that he and Officer Jones were radioed by Sergeant Nova and advised to deploy chemical agents into the number two side of the residence. Officer Altic said that he and Officer Jones were directed from what he could recall to deploy ten 37 mm rounds into the number two side of the residence. Officer Altic said it eventually ended up he and Officer Jones deployed numerous rounds at the residence until they were able to get several rounds into the residence. Officer Altic said it was difficult to get the 37 mm rounds into the window that was on the number two side of the residence, which was located toward the number three side of the residence.

Officer Altic said that he and Officer Jones had a 37 mm launcher each. The first volley they deployed into the number two side of the residence Officer Jones shot three rounds and Officer Altic shot two rounds alternating in between shots. Officer Altic said that the munitions they launched were CS powder rounds.

Officer Altic said that he and Officer Jones radioed the Command Post with the results of the munitions that made it into the residence. Officer Altic could not recall the exact number of munitions that made it into the residence. Officer Altic stated that after they radioed with their results they were advised to deploy a certain number of chemical agents into the residence but Officer Altic could not recall how many munitions were to enter the residence. Officer Altic said from the position they were currently in they shot a total of 21 rounds so that they could get all of the chemical agents that were to be delivered into the residence. I asked Officer Altic if he knew how many munitions they made into the residence and he believed it was six. Officer Altic believed that Sergeant Nova and Lieutenant Cavinta wanted a total of 10 munitions into the number two side of the residence. Officer Altic added that he and Officer Jones advised the Command Post that they were just wasting the munitions due to how far they were deploying them.

Officer Altic said that they were again radioed by the Command Post and advised to move to the number three side of the residence, which they did. Officer Altic said that there was more surrender orders given to [REDACTED] but no response. Officer Altic received orders from the Command Post to deploy five munitions into the number three side. Officer Altic said that he attempted with the 37 mm launcher to deploy the chemical agents into the A window. Officer Altic said that he was able to get two munitions into this window. Officer Altic said that there was also a B window on the number three side of the residence, which he fired two more munitions at and was able to get these two munitions in through the window. Officer Altic said in all, he launched five munitions and four entered into the residence.

I asked Officer Altic if he saw any of the SET team members deploy chemical agents into the number four side of the residence. Officer Altic said that he did not see but was aware that the SET team introduced 37 mm rounds and shotgun ferret rounds into the number four side of the residence. Officer Altic said shortly after deploying the 37 mm and shotgun ferrets the SET team approached the number four side of the residence on foot and deployed handheld chemical agents. Officer Altic did not know what type of handheld chemical agents the SET team deployed into the residence. Officer Altic said that the SET team members approached the number four side of the residence on two different occasions.

Officer Altic said after the handheld canisters were deployed there was smoke coming from within the residence. The smoke that was coming from the residence was white in color. Officer Altic said that the first delivery from the SET team there was a small amount of white smoke but on the second delivery, there was a larger amount of white smoke.

Officer Altic said that after about one hour had passed he began to notice a darker color of smoke coming out of the residence from the number four side. Officer Altic said that surrender orders were continuously being given to [REDACTED] but there was no response.

Officer Altic estimated that a few hours had passed and he began to see flames coming from the number four side of the residence. Officer Altic said that surrender orders were given to [REDACTED] all the way, up until the residence was fully engulfed by flames.

Officer Altic said that once the fire began he heard popping noises coming from the residence but he was unsure if it was from the residence being on fire or ammunition cooking off.

I asked Officer Altic since he had just returned from chemical agents training if he was familiar with a tri-chamber canister or grenade. Officer Altic believed that he was and stated that a tri-chamber canister emits smoke along with CS gas. The tri-chamber canister was not considered a pyrotechnic. I asked Officer Altic if he was familiar with the sting ball. Officer Altic said that he was and that when it was detonated it would shoot out numerous small rubber balls. Officer Altic said that he did not believe a sting ball was a pyrotechnic. I asked Officer Altic if he was familiar with a CS expulsion grenade. Officer Altic told me that while he was at training they sampled numerous types of chemical agents and he did not know if he could describe how an expulsion grenade worked.

I asked Officer Altic if he or Officer Jones brought any pyrotechnic chemical agents with them to Bloody Camp Rd. Officer Altic said that he and Officer Jones had some in their "go bag" but did not utilize any of them.

I asked Officer Altic if there were any discussions that he overheard regarding the use of pyrotechnic chemical agents. Officer Altic believed that he did hear some radio traffic in regards to the use of a pyrotechnic type of munition being used near the end of the standoff. Officer Altic said that after the SET team members deployed the second handheld chemical agent into the number four side of the residence he thought that this handheld might be a pyrotechnic. Officer Altic later learned that the handheld chemical agents were possibly not pyrotechnic.

I asked Officer Altic if he ever saw smoke coming from the chimney to the residence. Officer Altic said that he noticed white smoke coming out of the chimney when the SET team members deployed the second handheld chemical agent. I asked Officer Altic if he ever heard anything mentioned about [REDACTED] starting a fire inside of the residence and he said that he did not.

I asked Officer Altic what his opinion was of why the chemical agents did not drive [REDACTED] outside of the residence. Officer Altic said that [REDACTED] either had some way to hide from the deployed chemical agents or due to his [REDACTED] condition, he could withstand the agents. Officer Altic said that [REDACTED] could have sealed himself off from the contaminated areas of the residence.

I asked Officer Altic why chemical agents were never deployed into the number one side of the residence. Officer Altic said he believed that the chemical agents were never deployed on this side of the residence due to there being no cover.

I asked Officer Altic what weapons he was armed with during this incident. Officer Altic said when he first went out with Officer Sanchez he was armed with his AR-15 and his handgun. The second time he was deployed he was only armed with his handgun, which was a Glock 40 caliber handgun.

Investigator Dunn asked Officer Altic if he was aware of any of the Eureka Police Department's SWAT team members firing any of their weapons. Officer Altic said as far as he knew none of the SWAT team members fired any of their weapons.

Investigator Dunn asked Officer Altic what the distance was when he fired the 37 mm munitions from the number two side. Officer Altic believed it was about 70 yards.

I asked Officer Altic if he felt there could have been anything else done to have [REDACTED] exit the residence peacefully. Officer Altic said that he did not believe there was anything else that could have been done. This concluded our interview with Officer Altic.

On 6/8/07 at about 0845 hrs, I met with Investigator Hislop in my office. Investigator Hislop provided me with a CD that contained aerial photographs of the residence and area around Bloody Camp Rd. Investigator Hislop advised me that the photographs were taken by Investigator Cox and turned over to him. At about 0926 hrs, I turned the CD over to ET [REDACTED] so that she could review them and book the CD into evidence at the Sheriff's Office.

On 6/8/07 at about 1131 hrs, Investigator Dunn and I met with Lieutenant George Cavinta in his office in CID. The interview conducted with Lieutenant Cavinta was digitally recorded and placed onto CD. Refer to Investigator Dunn's report for further details regarding this interview.

On 6/14/07 at about 0830 hrs, I met with the CIRT team members Investigator Dunn, Investigator Hislop and Investigator Honsal in CID. Investigator Honsal advised us that he had contacted CDC Correctional Officer Jeff Ricker. Investigator Honsal believed that Correctional Officer Ricker was the Commanding Officer for CDC's tactical team.

Investigator Honsal told us that Correctional Officer Ricker said that he made an inventory check on the vest that the CDC tactical team provided to the SET team. Correctional Officer Ricker said that the vest was missing a han-ball, which was a pyrotechnic and two flameless tri-chamber canisters. Correctional Officer Ricker said that they did not have any sting balls in the vest because a sting ball was primarily used as a prison yard tool. Refer to Investigator Honsal's report for further details regarding the interview of Correctional Officer Ricker.

On 6/14/07 at about 1450 hrs, Investigator Honsal met with me in my office and turned over one han-ball and one flameless tri-chamber canister to me, which he had obtained from Correctional Officer Ricker. I later placed these two items into evidence at the Sheriff's Office.

At the same time I met with Investigator Honsal, ET [REDACTED] came into my office and provided me with photographs she had taken of CDC's vest while she was on scene. She also provided me with separate photographs of a han-ball and sting ball, which I attached to this case.

After meeting with Investigator Honsal and ET [REDACTED] I met with Lieutenant Cavinta in his office. I asked Lieutenant Cavinta if the SET team had any sting balls in their inventory. Lieutenant Cavinta researched this and said that the SET team had no sting balls. ✓

At about 1604 hrs, I digitally photographed the "to do list" that had been prepared by the CIRT team in CID. I later placed the photographs onto CD and placed the CD into evidence at the Sheriff's Office.

On 6/15/07 at about 0830 hrs, I met with Sergeant Quenell in my office. I advised Sergeant Quenell Investigator Dunn and I would need to speak with him and the other SET team members that were around when the chemical agents were deployed into the residence. Sergeant Quenell advised me that he would contact their attorney to arrange for these meetings.

On 6/15/07 at about 1022 hrs, Sergeant Quenell contacted me in my office and advised me that he had called attorney [REDACTED] and Attorney [REDACTED] would telephone me to arrange times to meet with the Deputies.

At about 1420 hrs, I was able to contact Attorney [REDACTED] on his cellular phone. Attorney [REDACTED] asked me what exactly and which Deputies I needed to speak to again. I advised Attorney [REDACTED] that I needed to speak to Sergeant Quenell, Brian Taylor, Jesse Taylor, Jamie Barney and Blake Massaro. I needed to speak to these Deputies regarding the transaction of chemical agents between CDC and the SET team members. Attorney [REDACTED] advised me that he did not see a reason for him to be present for these follow-up interviews.

On 6/20/07 at about 1035 hrs, Investigator Dunn and I met with Sergeant Bryan Quenell at his residence. We conducted a follow-up interview with Sergeant Quenell, which was digitally recorded and later placed onto CD. The following is a brief summary of that interview. Refer to the CD or transcript for further details.

I explained to Sergeant Quenell that we had spoken several days ago regarding CDC's vest and that they had made an inventory check of the vest and the vest was missing a han-ball and two tri-chamber canisters. I told Sergeant Quenell the purpose of meeting with him again was to clarify the transaction between his team members and the CDC tactical team.

I asked Sergeant Quenell if he had Attorney [REDACTED] present with him when Investigator Dunn and I had interviewed him before. Sergeant Quenell said that Attorney [REDACTED]

was present during the previous interview but Sergeant Quenell had spoken to Attorney [REDACTED] and Sergeant Quenell said that there was no reason for Attorney [REDACTED] to be present for this interview.

I asked Sergeant Quenell to go into more detail regarding the discussions of what chemical agents were going to be deployed into the residence. Sergeant Quenell said that Lieutenant Cavinta advised him via radio to have his team deploy the flameless CS canisters into the residence. According to Lieutenant Cavinta, a CDC tactical team member was going to be bringing these canisters to Sergeant Quenell. Lieutenant Cavinta also advised Sergeant Quenell that he could use "speed heat canisters" if [REDACTED] began firing upon the SET team members while they were deploying the flameless canisters.

Sergeant Quenell said that he eventually met with a CDC team member who had brought a black colored nylon vest to Sergeant Quenell's location, which was at the Tribal Police units that were parked on the driveway south of the number four side of the residence. Sergeant Quenell said that in the vest were tri-chamber flameless canisters, speed heat grenades.

Sergeant Quenell said whoever CDC's team leader was pulled a sting ball off the vest and told Sergeant Quenell that the sting ball had 32 caliber rubber bullets in it and it was rated for indoor use. The team leader told Sergeant Quenell that once the sting ball was deployed it would explode and the rubber bullets would be dispersed and Sergeant Quenell said that the team leader told him that there was a chemical agent that was also dispersed but Sergeant Quenell could not recall if the chemical agent was CS or OC.

I asked Sergeant Quenell if he could recall what the team leader for CDC looked like. Sergeant Quenell said that the team leader was about 5'7" to 5'8" tall and had an olive complexion and a dark mustache. Sergeant Quenell said that this team leader was in full tactical gear.

I asked Sergeant Quenell how the sting ball came into his team's possession. Sergeant Quenell said that initially Deputy Barney was fitted with the vest that CDC had brought to them. Deputy Barney was going to deploy the munitions from the vest. Sergeant Quenell said that he met with Deputy Barney and advised Deputy Barney to remove the vest so that there was no confusion on what was going to be deployed into the residence.

Sergeant Quenell said that Deputy Barney removed the vest and they removed two flameless CS tri-chamber canisters and placed these two canisters onto Deputy Barney's person. Sergeant Quenell said that the sting ball was also removed from the vest and placed onto Deputy Barney's person.

I asked Sergeant Quenell if this all occurred before the first deployment into the residence. Sergeant Quenell said that all of the above occurred before the second appointment of chemical agents. Sergeant Quenell said that on the first deployment they used the SET team's CS expulsion grenades.

I asked Sergeant Quenell on the second deployment who deployed the sting ball into the B window on the number four side of the residence. Sergeant Quenell said that Deputy Barney had deployed the sting ball. Sergeant Quenell said when Deputy Barney deployed the sting ball he could hear it explode within the residence and he could hear what he believed to be the rubber bullets bouncing around inside.

I asked Sergeant Quenell if he had ever seen a sting ball deployed before. Sergeant Quenell said that he had and from what he heard and observed on this occasion, it was consistent with a sting ball being deployed.

I asked Sergeant Quenell when the sting ball was handed over to his team if he observed it. Sergeant Quenell said that he did not examine the sting ball but knew what was handed over to Deputy Barney appeared to be a sting ball because it was round and black in color. Sergeant Quenell added that the SET team did have sting balls in their inventory and the sting balls the SET team had, had a white band around them and black writing.

Sergeant Quenell said that as far as he knew on this second deployment of chemical agents into the residence there was only a sting ball deployed and not a han-ball.

At this point, I showed Sergeant Quenell several photographs. I first showed Sergeant Quenell a photo of a vest. Sergeant Quenell told me that this vest was the vest that CDC had brought to his team. Sergeant Quenell said that the two canisters that were in the vest appeared to him to be a speed heat canisters. I also pointed out to Sergeant Quenell a person's hand that was near another chemical agent that was on the vest. I asked Sergeant Quenell if he could identify what the chemical agent was. Sergeant Quenell said that he believed it to either be a sting ball or han-ball.

I showed Sergeant Quenell another photograph of the vest lying in the back of a Tribal Police patrol unit. Sergeant Quenell said that this patrol unit was parked on the driveway and this was where his team had left the vest after removing the munitions that his team utilized.

I showed Sergeant Quenell a blown up photo of the sting ball or han-ball that was on the vest. Sergeant Quenell said to him that it appeared that the munition in the vest was a han-ball.

I lastly showed Sergeant Quenell photographs of a han-ball and sting ball. I asked Sergeant Quenell if he saw either of these two munitions on CDC's vest. Sergeant Quenell said that he did not examine the vest to see what was being carried on it, all he did was ask CDC's team leader to remove all of the munitions from the vest that were rated for indoor use.

I asked Sergeant Quenell if he knew what a han-ball was utilized for. Sergeant Quenell said that a han-ball was another way of deploying chemical agents and was rated for

outdoor use. Sergeant Quenell said that the only time he had seen a han-ball deployed was when he was in my office and I was observing a han-ball being deployed on my computer.

I asked Sergeant Quenell if I was correct in saying that if he would have been handed the han-ball he would have returned the han-ball to the CDC members because he did not want that type of chemical agent used in the residence. Sergeant Quenell stated that this would be correct. As far as Sergeant Quenell knew, Deputy Barney deployed a sting ball and not a han-ball into the residence.

Sergeant Quenell added that the main reason he wanted to use a sting ball was to keep [REDACTED] away from the windows and from shooting at the SET team members that deployed the chemical agents. Sergeant Quenell said that he also told CDC's team leader this. This concluded our interview with Sergeant Quenell.

On 6/20/07 at about 0700 hrs, I received an email from Deputy Kerry Ireland regarding the inventory of the SET team's chemical agents. At about 1245 hrs, Deputy Ireland telephoned me in my office and I confirmed with him that the email he had sent to me dated 6/20/07 was the most recent inventory for the SET team's chemical agents. Deputy Ireland advised me that this was correct and I attached the email that he had sent me to this case.

On 6/20/07 at about 1540 hrs, I telephoned Deputy Brian Taylor at his residence. I telephoned Deputy Taylor because he was unable to meet with me in person due to him working out of the Hoopa Station. The interview I conducted with Deputy Taylor over the telephone was digitally recorded and later placed onto CD. The following is a brief summary of the interview conducted with Deputy Taylor. Refer to the CD or transcript for further details.

I advised Deputy Taylor that I was going to record our conversation and he told me that would be fine. I explained to Deputy Taylor that I needed to obtain a more detailed statement regarding the transaction of chemical agents between CDC's tactical team and Sergeant Quenell and Deputy Barney. Deputy Taylor also advised me that he did not need Attorney [REDACTED] present with him during this interview.

I told Deputy Taylor that I understood that on 6/4/07, he, Deputy Jesse Taylor, Sergeant Quenell and Deputy Massaro were at the Tribal Police patrol units and a technical vest that was holding chemical agents was brought to them. Deputy Taylor said that this was correct. I asked Deputy Taylor what occurred during the transaction between the SET team members and the CDC tactical team members. Deputy Taylor said that a male CDC team member who appeared to be in charge of CDC's team brought the vest to Deputy Taylor's location. CDC's team leader met with Sergeant Quenell and Deputy Barney and there was a decision made not to take the vest with them when the SET team members approached the residence.

Deputy Taylor said that several munitions were removed from the vest that was going to be deployed into the residence. I asked Deputy Taylor if he knew what munitions were removed from the vest and Deputy Taylor said that he did not. Deputy Taylor said that he did know that all pyrotechnic munitions were left in the vest. I asked Deputy Taylor if he heard what the conversation was and Deputy Taylor said all that he heard was Sergeant Quenell say, "We don't want to burn the house down."

Deputy Taylor said that the CDC team leader placed the vest on the tailgate of one of the patrol units and either Sergeant Quenell or Deputy Barney removed the munitions that were going to be deployed into the residence. Deputy Barney then placed the munitions onto his person.

Deputy Taylor stated that he did not see what type of munitions Deputy Barney had because he was covering the number four side of the residence.

I asked Deputy Taylor if this all occurred before the second deployment of chemical agents into the residence. Deputy Taylor advised me that this was correct.

Deputy Taylor said that on the second deployment of chemical agents one handheld device was thrown through the A window of the number four side of the residence. Deputy Taylor said that he was unsure if there were one or two handheld devices thrown through the B window because he was holding the ballistic blanket and looking away from the residence.

I asked Deputy Taylor when these handheld devices were thrown through the windows if he heard a type of explosion. Deputy Taylor said that he could not recall hearing an explosion.

I asked Deputy Taylor before the second deployment of chemical agents into the number four side of the residence if there was any mention regarding a han-ball. Deputy Taylor said that he did not hear any mention of a han-ball and that he knew what a han-ball was. I asked Deputy Taylor if he ever heard any mention of a sting or stinger ball. Deputy Taylor said that he overheard that there was a stinger ball in the vest and there was conversation about the SET team members deploying it.

I asked Deputy Taylor if he could describe CDC's team leader to me. Deputy Taylor said that he had a mustache and was dark complected and was about 5'10" tall, weighing about 180 to 200 pounds.

I confirmed with Deputy Taylor that he was a grenadier for the SET team. Deputy Taylor stated that he was and was not consulted before any of the chemical agents were deployed into the residence.

Deputy Taylor added that he believed a tri-chamber canister was deployed into the A window on the second deployment of chemical agents. Deputy Taylor said that he did not physically see the canister but the canister was shaped like a tri-chamber canister and

he overheard Sergeant Quenell, Deputy Barney and CDC's team leader talking about a tri-chamber canister.

I asked Deputy Taylor if he could recall what the vest looked like that CDC's team leader provided to the SET team members. Deputy Taylor said it was a typical raid vest that was made of black nylon and had numerous pockets on it.

I asked Deputy Taylor if he knew what a han-ball looked like. Deputy Taylor said that it looked very similar to a stinger ball and that a han-ball would have a white stripe around it and han-ball would be printed on it in black lettering. Deputy Taylor said that a stinger ball would look just like a han-ball and he believed the stinger ball would have "stinger" written on it.

Deputy Taylor said that a han-ball was a pyrotechnic and a stinger ball could be used indoors. This concluded my interview with Deputy Taylor.

On 6/21/07 at about 0922 hrs, I sent emails to Deputies Jamie Barney, Blake Massaro and Jesse Taylor advised in them that I needed to speak to them in regards to the deployment of the chemical agents on Bloody Camp Rd. I attached to this email and replies from the Deputies to this case.

On 6/21/07 at about 1032 hrs, I received a fax from the Humboldt County Coroner's Office regarding the results of [REDACTED] toxicology. The fax was a toxicology report from Central Valley Toxicology. [REDACTED] toxicology returned "presumptive positive" for THC metabolite and negative for LSD.

[REDACTED] toxicology returned positive for methamphetamine at 0.08 mg/L and amphetamine at 0.03 mg/L. Refer to the attached report for further details.

On 6/26/07 at about 1001 hrs, Investigator Dunn and I met with Humboldt County Sheriff's Office Deputy Blake Massaro at the Sheriff's Office. We interviewed Deputy Massaro in my office and the interview was digitally recorded. Refer to Investigator Dunn's report for further details regarding this interview.

On 6/26/07 at about 1025 hrs, Investigator Dunn and I met with Humboldt County Sheriff's Office Deputy Jamie Barney at the Sheriff's Office. We interviewed Deputy Barney in my office and the interview was digitally recorded. Refer to Investigator Dunn's report for further details regarding this interview.

On 6/27/07 at about 1312 hours, Investigator Dunn and I met with Humboldt County Sheriff's Office Deputy Jesse Taylor at the Sheriff's Office. We interviewed Deputy Taylor in my office and the interview was digitally recorded. Refer to Investigator Dunn's report for further details regarding this interview.

On 6/27/07 at about 1414 hrs, I met with Humboldt County Sheriff's Office Sergeant Mike Fridley in my office. I knew that Sergeant Fridley had been previously interviewed

by Detective Quenell on 6/4/07 regarding the incident involving [REDACTED] [REDACTED]. I had earlier spoken with Investigator Dunn and he advised me that he had briefly spoken to Sergeant Fridley. Sergeant Fridley advised Investigator Dunn that while he was giving surrender orders over the public address system he overheard the conversations and transaction between CDC's tactical team and the SET team regarding what chemical agents were to be deployed into the residence. I interviewed Sergeant Fridley regarding this and the interview was digitally recorded and later placed onto CD. The following is a brief summary of the interview I conducted with Sergeant Fridley. Refer to the CD or transcript for further details.

I explained to Sergeant Fridley that I had spoken to Investigator Dunn and he advised me that he had spoken to him and that he had stated that he had seen the transaction of chemical agents between CDC and the SET team. Sergeant Fridley told me that was correct.

Sergeant Fridley said that he was one of the Sheriff's Office negotiators that were present during the incident with [REDACTED] [REDACTED]. Sergeant Fridley said that during the second day of the incident with [REDACTED] [REDACTED] he was at the second Tribal Police patrol unit that was parked on the driveway. Sergeant Fridley was attempting to negotiate with [REDACTED] through the public address system that was in the patrol unit.

Sergeant Fridley said that at one point he stopped utilizing the public address system because several SET team members met with a CDC tactical team member who had brought a vest to their location. Sergeant Fridley said that they met just in front of the patrol unit he was at. Sergeant Fridley said that the vest that the CDC team member had brought was filled with chemical agents and was black in color.

I asked Sergeant Fridley what this CDC tactical team member looked like. Sergeant Fridley said he was about 5'3" tall, had a muscular thin build and had a thin mustache.

I asked Sergeant Fridley whom exactly this CDC tactical team member was speaking too. Sergeant Fridley said that the main two people he was talking with were Sergeant Quenell and Deputy Barney. Sergeant Fridley said that he overheard them after the ferret rounds had been introduced into the residence, talking about introducing chemical agents with smoke in them.

Sergeant Fridley said that he saw the CDC team member remove several munitions from the vest and explained to Sergeant Quenell and Deputy Barney that some of the munitions were pyrotechnic and some were not. Sergeant Fridley said that the CDC team member and Sergeant Quenell had concerns about introducing something into the residence that could start a fire. Sergeant Fridley said that he did not see what munitions Sergeant Quenell and Deputy Barney took from the CDC team member.

I asked Sergeant Fridley if he heard anything mentioned about a stinger ball or han-ball. Sergeant Fridley said that he did and that the CDC team member removed what Sergeant Fridley described as a black ball that looked more like a grenade. The team member told

Sergeant Quenell and Deputy Barney that it was a "yard ball" or "yard buster" and when it was deployed, they would explode and shoot out rubber pellets. Sergeant Fridley added that he believed the CDC team member said that this munition had either CS or OC gas that would deploy from it when detonated.

I asked Sergeant Fridley if he saw any type of writing on this munition and he said that he did not.

I asked Sergeant Fridley if he ever saw any canister type of munitions provided to Sergeant Quenell or Deputy Barney. Sergeant Fridley said that he did but he could not recall how many canisters he saw turned over to them.

I asked Sergeant Fridley when the SET team members approached the residence on the second deployment of the handheld devices if he heard anything when these munitions were deployed. Sergeant Fridley said that he did not.

I asked Sergeant Fridley if he had any experience with chemical agents. Sergeant Fridley said that when he was in the Army he was a nuclear biological chemical specialist. Sergeant Fridley said that he was not familiar with the chemical agents that were used during this incident though.

At this point, I showed Sergeant Fridley a photograph of the vest that CDC had provided to the SET team. Sergeant Fridley said that this was the vest that the CDC team member had provided to Sergeant Quenell and Deputy Barney. I then showed Sergeant Fridley a photograph of a speed heat canister. Sergeant Fridley said that he never was able to read the print on the canisters that were turned over to Sergeant Quenell and Deputy Barney but the canisters were similar to the one in this photograph.

I showed Sergeant Fridley the photograph of the vest and han-ball that was inside of it. I asked Sergeant Fridley if this munition looked familiar to him. Sergeant Fridley said that this munition looked similar to the munition that was turned over to Sergeant Quenell and Deputy Barney. Sergeant Fridley added that the round munition that was turned over to Sergeant Quenell and Deputy Barney, he was unable to see what type of print was on this munition. Sergeant Fridley said that this munition was what the CDC team member described as a yard ball.

I showed Sergeant Fridley a photograph of the vest lying in the back of one of the Tribal Police patrol units and Sergeant Fridley believed this was the same vest provided by the CDC and believed it was placed in the patrol unit that was parked in front of the patrol unit he was utilizing the public address system from.

I showed Sergeant Fridley the photographs of the stinger ball and han-ball and Sergeant Fridley said that either one of these munitions could have been what was turned over to Sergeant Quenell and Deputy Barney.

Sergeant Fridley added that the CDC team member wanted Deputy Barney to wear the vest that he had provided to him but Sergeant Quenell decided against this because he did not want Deputy Barney to confuse any of the munitions that were going to be deployed.

Sergeant Fridley said that he did not see the CDC team member turned the munitions over to Sergeant Quenell or Deputy Barney. This concluded my interview with Sergeant Fridley.

On 7/3/07 at about 1411 hrs, I met with Lieutenant Cavinta in his office and he advised me that he had just received a telephone call from Chief Hostler. Chief Hostler told Lieutenant Cavinta that he had sent one of the Tribal Police patrol units to Harper Ford in Eureka so that the damage from the gunshots from [REDACTED] [REDACTED] could be repaired. While the patrol unit was being repaired at the body shop one of the employees of Harper Ford found what they believe to be a gunshot hole in the driver's side doorjamb. Lieutenant Cavinta advised me that he was going to have Detective Kirkpatrick respond to Harper Ford to confirm that it was a gunshot hole.

I later met with Detective Kirkpatrick in CID and he showed me several photographs that he had taken. From the photographs, it appeared that there was a gunshot into the driver's side doorjamb of the patrol unit. It appeared to both Detective Kirkpatrick and I. That one of the Deputies that had returned fire on [REDACTED] [REDACTED] had accidentally discharged his weapon into the doorjamb.

This case will be submitted to the District Attorney's Office for review. No criminal charges have been requested by the CIRT team regarding this investigation.

I placed all CD statements and photographs into evidence at the Sheriff's Office. It should be noted that not all of the transcribed statements were completed at the time I submitted this case. As the transcripts are completed, I will forward them to the District Attorney's Office.

If any further information is received regarding this investigation, a supplemental report will be completed.

Prepared by: Detective Rich Schlesiger #0931

Reviewed by: Undersheriff Mike Downey #0653

Lt. Knight. [REDACTED]
 Lt. Cavinta. [REDACTED]

**EUREKA POLICE DEPARTMENT
 WATCH COMMANDER'S DAILY REPORT**

ite: 060407

Day of Week: Monday

Watch Commander: NOVA

WATCH	OFFICER	ID	BEAT	VEH	RADIO	CODE	TASSE	CHECK	RECRUITS	REMARKS
									RIDE-ALONGS	(Court, flex, special assignments, etc.)
	NOVA	224	SWC							[REDACTED]
	Wilcox	64	SW							
	Sanchez	83	SW							
	Johnsen	423	SW							
	Jones	67	SW							- GA. Grenadier
	Harpham	419	SW							
	Hill	95	PR							
	Cooper	52	PR							
	Aitic	89	PR							- C.A. Grenadier
	[REDACTED]	205	TD						SWAT-	[REDACTED] TO cell [REDACTED]
	Howden	470	CNT							
	Wilson	76	CNT							

Training

Absence

C [REDACTED] - Bloody camp rd.

Operational Issues

Sensitive Issues

Commendations

SECTION 1 - INCIDENT PROFILE

Date of Incident: 060407 Time of Incident: 060307/1700

Location of Incident: Loop Rd / Pine Creek Rd - Hoopa

Officers Involved; Last Name, First Name)	Assignment	Notes
1. NOVA, Bill	SWAT CMPR	
2. Wilcox, Todd	Team Ldr	
3. Sanchez, Rigo	ATL	
4. Johnson, Mike	SWAT	
5. Jones, Tim	SWAT / c.A. Grenadier	
6. Harpham, Ron	SWAT	
7. Hill, Greg	Patrol Rifle	
8. Cooper, Gary	Patrol Rifle	
9. AHC, Louis	Patrol Rifle -	c.A. Grenadier
	Tact. Disp.	
11. Howden, Kay	CNT	700 @ 0900 060407
12. Wilson, Eddie	CNT	
13.		
14.		
15.		
16.		
17.		
18.		

Perimeter(s)	Location	Comments
Inner Perimeter	Bloody Camp Rd.	
Outer Perimeter	"	"

Command Post	Location	Comments
S.W.A.T.	CP	- Bloodycamp Rd
C.N.T.	CP	- Bloodycamp Rd.
Fire		
Evacuation Site		
Medical Site		

Notifications	Responding	ETA	Comments
<input type="checkbox"/> W/C			
<input checked="" type="checkbox"/> S.W.A.T. Commander	on Scene		Bloodycamp Rd. - CP
<input type="checkbox"/> CRU Cmdr.			
<input type="checkbox"/> Chief of Police			
<input checked="" type="checkbox"/> Fire/EMS	staged near the cross		Bloodycamp Rd. - CP

Radio Frequency	Frequency #	Established Y/N
Primary		Y
Tactical	HCSO main	

SECTION 2 – LOCATION OF INCIDENT

Address/Landmark: Bloody camp Rd.

Location Type (Check All That Apply)

<input checked="" type="checkbox"/> Building
<input type="checkbox"/> Conveyance
<input type="checkbox"/> Open Air
<input type="checkbox"/> Other

If Building, Select Type (Choose ONE)

<input type="checkbox"/> Commercial Building
<input type="checkbox"/> Government Building
<input checked="" type="checkbox"/> Single Family Residence <i>trailer</i>
<input type="checkbox"/> Town House/Condo/Apartment
<input type="checkbox"/> Other:

Number of Levels: 1

Number of Rooms: X 5

*3 bedrooms
1 bath
1 kitchen/living room*

If Building, Select Fortifications (Choose ONE)

<input type="checkbox"/> No Unusual Fortification
<input type="checkbox"/> Light Fortifications
<input type="checkbox"/> Heavily Fortified

If Conveyance, Select Type (Choose ONE)

<input type="checkbox"/> Sedan/Passenger Car
<input type="checkbox"/> Van
<input type="checkbox"/> Pick-up/Sport Utility Vehicle
<input type="checkbox"/> School Bus
<input type="checkbox"/> Commercial Bus
<input type="checkbox"/> Train
<input type="checkbox"/> Aircraft
<input type="checkbox"/> Other:

SECTION 3 – INCIDENT TYPE

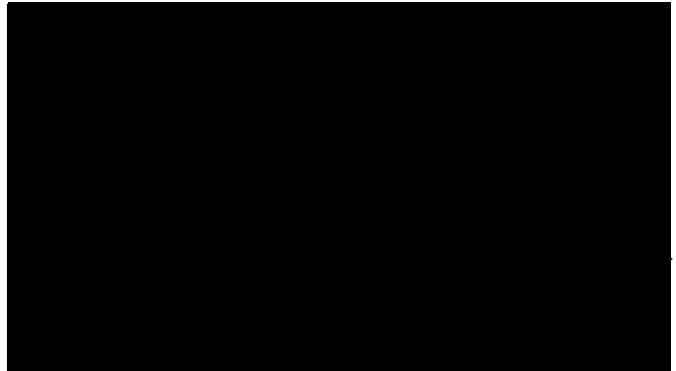
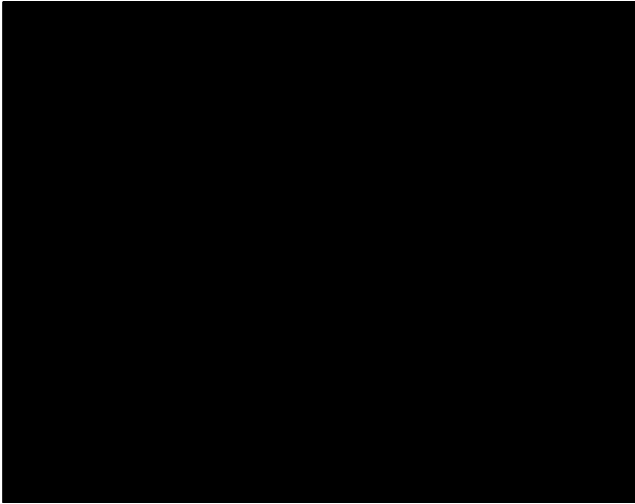

If Warrant, Warrant Type (Check All That Apply)
<input type="checkbox"/> Felony Arrest
<input type="checkbox"/> Search
<input type="checkbox"/> Other:

If Warrant, Reasons for Warrant (Check All That Apply)
<input type="checkbox"/> Explosives
<input type="checkbox"/> Firearms
<input type="checkbox"/> Narcotics
<input type="checkbox"/> Wanted Person
<input type="checkbox"/> Other:

If Barricade, Reasons for Barricade (Check All That Apply)
<input type="checkbox"/> Deliberate Hostage Taker
<input type="checkbox"/> Disgruntled Employee
<input type="checkbox"/> Disgruntled Employer
<input type="checkbox"/> Domestic Dispute
<input type="checkbox"/> Interrupted Crime in Progress
<input type="checkbox"/> Kidnap for Ransom
<input type="checkbox"/> Termination of Pursuit
<input type="checkbox"/> Warrant Turned Barricade
<input type="checkbox"/> Other:

SECTION 4 - [REDACTED]

If more than one [REDACTED] reproduce this section and complete all four parts: Profile, Weapons and Logistics, Activity, and Disposition.

[REDACTED]

Gender: (M) F Age: [REDACTED] Race: IMA Height: 5'10" Weight: 180

[REDACTED]

[REDACTED] Weapons and Logistics

Offender Logistics (Check All That Apply)	
<input type="checkbox"/> Gas Mask	
<input type="checkbox"/> Ballistic Armor	
<input type="checkbox"/> Military Uniform or Variation	
<input type="checkbox"/> Police Uniform or Variation	

Offender Firearms (Check All That Apply)	
Type	# of Guns
<input type="checkbox"/> Handgun, Revolver	
<input type="checkbox"/> Handgun, Semi-Auto	
<input type="checkbox"/> Rifle, Bolt Action	
<input type="checkbox"/> Rifle, Semi-Auto	
<input checked="" type="checkbox"/> Rifle, Other	
<input checked="" type="checkbox"/> Shotgun	
<input checked="" type="checkbox"/> Automatic Weapon	

Other Weapons (Check All That Apply)	
<input type="checkbox"/> Edge Weapon	
<input type="checkbox"/> Vehicle	
<input type="checkbox"/> Blunt Impact	
<input type="checkbox"/> Other: (specify)	

Explosives (Check All That Apply)	
Check if Possessed	Check if Used
<input type="checkbox"/> Black Powder	<input type="checkbox"/>
<input type="checkbox"/> Booby-Trap	<input type="checkbox"/>
<input type="checkbox"/> Dynamite	<input type="checkbox"/>
<input type="checkbox"/> Hand Grenade	<input type="checkbox"/>
<input type="checkbox"/> Hazardous Material	<input type="checkbox"/>
<input type="checkbox"/> Hoax Device	<input type="checkbox"/>
<input type="checkbox"/> Incendiary Device	<input type="checkbox"/>
<input type="checkbox"/> Military Ordinance	<input type="checkbox"/>
<input type="checkbox"/> Pipe Bomb	<input type="checkbox"/>
<input type="checkbox"/> Plastic Explosive	<input type="checkbox"/>
<input type="checkbox"/> Smokeless Powder	<input type="checkbox"/>
<input type="checkbox"/> Other: (specify)	

SECTION 4 - [REDACTED] CONTINUED

Activity

Number of Shots Fired by the [REDACTED] Prior to Deployment of the Tactical Team: 2 @ HCSD

Who Were the Shots Directed At (Check All That Apply)
<input type="checkbox"/> No One/Random
<input type="checkbox"/> Civilians
<input checked="" type="checkbox"/> Officers <u>HCSD</u>
<input type="checkbox"/> Structure
<input type="checkbox"/> Victim
<input type="checkbox"/> Other:

Firearm Offender Discharged (Check All That Apply)
<input type="checkbox"/> Handgun, Revolver
<input checked="" type="checkbox"/> Handgun, Semi-Auto
<input type="checkbox"/> Rifle, Bolt Action
<input type="checkbox"/> Rifle, Semi-Auto
<input checked="" type="checkbox"/> Rifle, Other
<input type="checkbox"/> Shotgun
<input type="checkbox"/> Full-Auto Weapon

Who was Injured or Killed by Offender's Actions (Check All That Apply)
<input checked="" type="checkbox"/> No One
<input type="checkbox"/> [REDACTED]
<input type="checkbox"/> Victim(s)/Hostage(s)
<input type="checkbox"/> Officer(s)
<input checked="" type="checkbox"/> Other: <u>Damage to 2 Tribal vehs.</u>

Demand Made	[REDACTED] Told PD Will Comply		Made Prior to Tactical Team Arrival		Comments
	<input type="checkbox"/> Yes	<input type="checkbox"/> No	<input type="checkbox"/> Yes	<input type="checkbox"/> No	
<input type="checkbox"/> None	<input type="checkbox"/> Yes	<input type="checkbox"/> No	<input type="checkbox"/> Yes	<input type="checkbox"/> No	<u>NO negotiations so far.</u>
<input type="checkbox"/> Cigarettes	<input type="checkbox"/> Yes	<input type="checkbox"/> No	<input type="checkbox"/> Yes	<input type="checkbox"/> No	
<input type="checkbox"/> Food	<input type="checkbox"/> Yes	<input type="checkbox"/> No	<input type="checkbox"/> Yes	<input type="checkbox"/> No	
<input type="checkbox"/> Money	<input type="checkbox"/> Yes	<input type="checkbox"/> No	<input type="checkbox"/> Yes	<input type="checkbox"/> No	
<input type="checkbox"/> Water	<input type="checkbox"/> Yes	<input type="checkbox"/> No	<input type="checkbox"/> Yes	<input type="checkbox"/> No	
<input type="checkbox"/> Transportation	<input type="checkbox"/> Yes	<input type="checkbox"/> No	<input type="checkbox"/> Yes	<input type="checkbox"/> No	
<input type="checkbox"/> Other:	<input type="checkbox"/> Yes	<input type="checkbox"/> No	<input type="checkbox"/> Yes	<input type="checkbox"/> No	

SECTION 5 - [REDACTED] [REDACTED]

Number of Victims/Hostages Involved in Incident: _____

Enter Victim/Hostage Profile Information for Each Victim/Hostage. If More Than Three Victims/Hostages, Reproduce This Section.

#1 Victim/Hostage Profile

Name: (optional) _____

Gender: M F Age: _____ Race: _____ Height: _____ Weight: _____

Relationship to [REDACTED] (Choose ONE):

<input type="checkbox"/> None/Stranger
<input type="checkbox"/> Family Member (specify):
<input type="checkbox"/> Employer

<input type="checkbox"/> Acquaintance
<input type="checkbox"/> Employee
<input type="checkbox"/> Other (explain):

Photo [] Yes [] No

#2 Victim/Hostage Profile

Name: (optional) _____

Gender: M F Age: _____ Race: _____ Height: _____ Weight: _____

Relationship to [REDACTED] (Choose ONE):

<input type="checkbox"/> None/Stranger
<input type="checkbox"/> Family Member (specify):
<input type="checkbox"/> Employer

<input type="checkbox"/> Acquaintance
<input type="checkbox"/> Employee
<input type="checkbox"/> Other (explain):

Photo [] Yes [] No

#3 Victim/Hostage Profile

Name: (optional) _____

Gender: M F Age: _____ Race: _____ Height: _____ Weight: _____

Relationship to [REDACTED] (Choose ONE):

<input type="checkbox"/> None/Stranger
<input type="checkbox"/> Family Member (specify):
<input type="checkbox"/> Employer

<input type="checkbox"/> Acquaintance
<input type="checkbox"/> Employee
<input type="checkbox"/> Other (explain):

Photo [] Yes [] No

DEPARTMENT ACTION LOG

Date: 060407

Page: 1

Incident #: _____

Time	Info Source	Chronological - Action/Information/Occurrences	Recorded
0302	HCSO	CNT moving down	
0311	HCSO	Garcia entrt with 52 + 49.	
0313	HCSO	Queneau moving EPD up.	
0337	49	Cooper I'm now coming in from behind	
0340	L24	Imm. threat. Susp w/gun approaching. Rules of engagment.	
0346	L24	2 of 3 teams in place.	
0352	L24	we still have one team awaiting a guy in place.	
0400	L24	I am moving up to K64's position.	
0403	L24	L24 64 I'm coming up on your 6.	
0405	HCSO	Team 2 out CP -	
0407	HCSO	Miller entrt Team 3 (Bishop/Ireland) location	
0413	49	L24 we have had extensive movement on what we believe is the 2 side of the house	
0419	K64	L24 we are going to move up. There is another tree in front of this one.	
0419	L24	rgr. take it slow and easy.	
0424	49	L24 we have poor position for daylight because there is a tree located in front of the house. neither near or further are any positions that will work.	
0424	L24	Fall back to a position to cover poor side.	
0424	49	I can find a position possibly to provide containment but I will lose visibility	
0425	49	because the tree of window and lose visibility of the door.	

DEPARTMENT ACTION LOG

Date: 060407

Page: 2

Incident #: _____

Time	Info Source	Chronological - Action/Information/Occurrences	Recorder
0425	L24	Get a good cover fallback position Safety is priority.	
0425	49	THAT we ^{can} back up the truck 70 yards, but I'm	
0425	49	concerned about the tactical element. Only one person to cover retreat and it	
0426	49	may cause him to start firing.	
0426	49	We will wait until the last min. when HCSO returns to help cover.	
0426	L24	Copy. Be prepared to do it on your own.	
0437	1664	L24, we have decent visual on window A. L24 copy.	
0442	83	83 pure static. L24 copied.	
0448	L24	64, exit back to our position.	
0448	1604	low volume.. much better place to deploy C.A.	
0448	L24	copy. you are going to have nautical	
0448	L24	Sunrise back lighting you bad in 20 mins.	
0449	L23	Be advised we have loud.. static low volume -acknowledge by L24.	
0454	L23	L24, moved back to the 1st tree. In position again.	
0454	L24	copy we have movement B-window	
0455	L24	All units we have movement 4 side window B. 4 side window B.	
0457	49	L24 and other units we are going to be starting up a truck and trying to back	
0457	49	it out.	
157	L24	Rgr. movement 4 side opening B-boy 4 side opening B-boy.	

DEPARTMENT ACTION LOG

Date: 060407

Page: 3

Incident #: _____

Time	Info Source	Chronological - Action/Information/Occurrences	Recorder
0459	UNIK	static transmissions X 2. unreadable	
0500	L24	COPY	
0501	L24	We got light B opening 4 side 4 side B opening	
0501	L24	64 L23 exit back to jump point.	
0502	49	83 (pure static) movement complete. lost a little on the alcove. we have windows	
0502	49	on 2 side and 1 side.	
0502	UNIK	pure static - 83 acknowledging (?)	
0509	L24	returning to TOC. Appears lights are out in the house at this point.	
0522	K64	out TOC.	
0608	L24	Situation Report request. 52 + 49 - situation same as before C4	
0608	K64	83 + 89 - C4	
0618	K64	we have re-established visuel on window A side 4.	
0650	L24	64 I'm coming in on you 6.	
0657	L24	83 + 49 we are going to do an evolutionary changeover starting in 30 or 45.	
0756	HCSO	moving in to release EPD	
1001	█	Comm. Check complete. units enrt to Staging location	
1010	Carinta	REACH Has an eta 115min. contacting CHP. (ALS)	
1010	HCSO	HCSO Team 1 on side 4/3 HCSO Team 2 on side 1/2	
1010	HCSO	Lundie/Ireland on side 2/3 Sniper on side 2/3 + 1/2	

DEPARTMENT ACTION LOG

Date: 060407

Page: 4

Incident #: _____

Time	Info Source	Chronological - Action/Information/Occurrences	Recorder
1010	CDC	CDC Staged IFO TOC. 1 CDC unit in TOC	
1043	HCSO	REACH referred us to CHP, CHP Declined. CDF will roll if needed. Meet at	
1043	HCSO	Valley Floor in Hoopa. (Hoopa Airport) 2nd [REDACTED]	
1048	L24	They are giving options now.	
1051	XIO Covinta	communications began 5 ago.	
1052	XIO	IF communications halted, options will begin at 1105	
1102	XIO	communications started	
1107	XIO	communications halted	
1110	CDC	CDC repositioned IFO TOC.	
1111	XIO	communications int.	
1112	XIO	confirmed clear to enter gas.	
1112	HCSO Covinta	Affirmative. mass check.	
1114	XIO	Be advised gas is going initiated.	
1119	XIO	5 in to the AB windows 4 side	
1121	HCSO Covinta	XIO in 5 mins. reload 5 in A+B.	
1122	XIO	3883 enrt to Irelands location (2/3 side)	
1124	HCSO	3883 out with Ireland	
1126	XIO	2nd volley started	
128	HCSO Covinta	code 33 / HCSO main	

DEPARTMENT ACTION LOG

Date: 060407

Page: 5

Incident #: _____

Time	Info Source	Chronological - Action/Information/Occurrences	Records
1132	X10	Rounds entered, no movement	
1135	HCSO Covinta	Confirm no movement?	
1135	X10	Broken window 1 side.	
1135	HCSO Covinta	move to 112 side ^{enter} 5 5 into Masterbedm	
1136	Bishop	movement into the the 2 side window	
1137	Bishop	bedroom [REDACTED] crawling on the ground.	
1137	X10	move EPD up for volley on side 2. we are out.	
1139	X10	EPD moving into place will notify when there	
1140	HCSO Covinta	Prepare for another Surrender order	
1141	HCSO Covinta	immediately after 5 volleys	
1147	CDC	5 additional CDC ofc. and ^{ent}	
1156	K64	Raise Bishop.	
1156	K64	We need to come up Square on 2 side	
1156	K64	We don't know where you are.	
1156	Bishop	I have a visual on the window on the 2 side and front door.	
1157	K64	What is your range?	
1157	Bishop	105 yards	
1200	K64	Bishop. Confirm if we stay east of the barbed wire fence we will not be in your	
200	K64 Bishop	Field of fire? Bishop. Affirmative, K64 moving.	

DEPARTMENT ACTION LOG

Date: 060407

Page: 6

Incident #: _____

Time	Info Source	Chronological - Action/Information/Occurrences	Recorder
1203	K64	67 - 84 yards that is it	
1203	67	HCSO gas team. At your distance how high are you aiming?	
1203	HCSO	At the top edge of the window.	
1204	K64	67 I am coming back to you.	
1206	L24	K64, 5 good rounds. 1st volley misses. 2nd volley of 5 with imm. fu	
1206	HCSO COVINTA	X10 imm. following EPD 10 volley go with 10 of our own. on our side.	
1206	X-10	X-wind. 12 ga.	
1208	X10	going w 110.	
1209	K24	K64 once in place advise approx. distance	
1209	HCSO COVINTA	Both warrants signed along with Raimey	
1210	67	81 yards	
1210	L24	67 proceed when ready 67 roger.	
1211	L23	Stand by team is in position	
1213	K64	We are masking. will advise when we begin deploying.	
1218	K64	Proceeding with gas.	
1218	Visual	██████████ ██████████ ██████████	
1219	K64	we have 3 into the room.	
1220	67	we are pushing limits of the equipment we have 3 more now.	
1221	L24	67. 4 more when the HCSO is done,	

DEPARTMENT ACTION LOG

Date: 060407

Page: 7

Incident #: _____

Time	Info Source	Chronological - Action/Information/Occurrences
1222	X10	we are done.
1222	L24	67 go ahead with 4.
1222	67	It is in.
1224	67	we have 4 in
1224	HCSO Covinta	X10 go ahead with surrender orders X10 for 15 mins.
1224	HCSO Covinta	CODE 33 cancel. HCSO main
1237	64	PER RANGE FOR FURTHER ABENT ON #2 SIDE. PER. TO RECON #3 SIDE DODGES FOR BETTER RANGE -
1239	X10	BROADCASTS LEASTO -
1239	BISHOP	NEE. MOVEMENT SIDES TWO
1240	K64	leaving [redacted] side 2 [redacted] recon side 3
1246	HCSO Covinta	X10 continue commands for 5 minutes. no movement on the 2 or 4 side
1253	L23	83 confirm you heard that too? static. L23 banging noises heard. no visual on susp
1254	L23	83 has visual 2/3 side. I only have 3 side
1254	Bishop	movement side 2 susp uncovered himself with a large thick blanket.
1257	L23	per 83 movement pass. coming from 2/3 corner. Bishop confirmed.
1255	L24	K64 ETA on deployment on side 3. K64 moving in. L24 4.37 spaced.
1258	L24	K64 int. deployment. when set advise us.
1258	K64	we are about 5 out.

DEPARTMENT ACTION LOG

Date: 060407

Page: 8

Incident #: _____

Time	Info Source	Chronological - Action/Information/Occurrences	Recorder
1304 1304	67	83 we will be at your 5 o'clock just above you. Masking now.	
1307 1307	X10	We will have to break a pane of windows then attempt w/ 12g. to get 2nd pane to break	
1308 1308	X10	then re-evaluate for wants for C.S. grenade (parrots). Prepare for port-covinta.	
1308 1308	67	Ready to gas	
1309 1309	67	commencing gas	
1311	67	4 in. - 3 side.	
1311	X10	porting window	
1314	X10	able to partially break the window but can't get a grenade through.	
1315	X10	There is a fence between us and the house hard to move up safely. We need 1 sniper	
1315	X10	on the 4 side to cover move.	
1317	67	Do you want us to deploy rounds 2/3 side closest corner?	
1319	L24	67. Hold and cover	
1320	CDC	4 CDC with 1 squad leader. (2 of 4 are snipers)	
1320	DA Histop.	Advises his wife spoke with anonymous rp stating possible C4 inside. Det enrt 2 interview Matt Moore seen w/ C4.	
1322	HCSO covinta	X10 advised of above information	
1324	X10	Be advised large handgun seen on a shelf on Side 4 Window A.	
1330	X10	CDC in place. 1/4 corner opp. window A 1 canister. Window B 1 canister retreat	
1330	X10	same way. CDC with cover from veh. waiting for your go. (elusive blanket used)	
331	HCSO covinta	clear and proceed.	

DEPARTMENT ACTION LOG

Date: 060407

Page: 9

Incident #: _____

Time	Info Source	Chronological - Action/Information/Occurrences	Recorder
1338	X1	X10'S team is moving up.	
1339	X1	Team is halfway to the residence.	
1340	X1	Team is at window A gas inserted.	
1340	X1	Gas inserted into window B retreating back	
1340	HCSO Covinta	Fridley advise to start surrender commands.	
1341	X1	Team is back.	
1344	HCSO Unk.	product discharged from canisters. communications (surrender)	
1348	L24	Good deployment. confirm large ca. handgun S-4 W-A	
1350	X10	CDC advises they have more flameless canisters if needed.	
1352	L24	67 do we have any PYRO. c. s.	
1352	67	64 can check. we have non-PYRO and grenade. mike lights	
1353	K64	negative	
1355	X10	CDC enrt w/ blanket & halogens.	
1356	L24	67 confirm you have some mighty mights with you.	
1356	K64	negative for 67. 67 L24, in the truck	
1357	67	w/ bearing vest + 1 pyro PKT grenade.	
1359	L24	67/64 what hand held do we have with the team down there	
1359	K64	4 grenades - CS	
400	K64	the approach to 2/3 corner or 2 side has a lot of open ground, not desirable	

DEPARTMENT ACTION LOG

Date: 060407

Page: 10

Incident #: _____

Time	Info Source	Chronological - Action/Information/Occurrences	Recorder
1401	67	64, approach on to 2/3 corner, large ^{large} window we ported on side 2.	
1403	HCSO Cavinta	CD cent w/ the blanket and vest. for deployment Side 4 Window A & B.	
1406	K64	advised X-10's deploying side 4 A/B.	
1408	CDC	Blanket got to 2 vans getting ready for deployment.	
1411	83	67 rgr. covering.	
1415	HCSO 27 Sles.	no CH. on LSD + meth.	
1417	X1	Team is moving forwarded. masked up.	
1417	X1	Team is halfway to residence.	
1418	X1	Dog on scene. Smoke introduced to window A	
1419	X1	Team at window B smoke intr 2 times Team standing by un k if canister went in	
1419	X1	Team moving back smoke coming from both windows.	
1420	L24	once X10 team is back have them go and start announcements.	
1420	X1	Team is back. Starting announcements.	
1421	X10	Both canisters successfully deployed (window A) B-window sting ball introduced.	
1422	X10	Smoke coming out of roof vents.	
1428	X1	communications ending.	
1430	L24	To perimeter units to you have any movement	
1431	67	67 nothing on #3 HCSO nothing on #1 L23 nothing on #2	
1432	X10	Any smoke on #2 side? Garcia - none on #2 or #1 side	

DEPARTMENT ACTION LOG

Date: 060407

Page: 11

Incident #: _____

Time	Info Source	Chronological - Action/Information/Occurrences	Recorder
1436	L24	we have fire int. verbal surrender comms. notify fire. perimeter unit	
1437	L24	maintain maximum surv. 67 side 3 team holding.	
1437	█	Fire staging where TOC was. TOC relocated to Bloody/camp Rd.	
1440	L24	code 33 main	
1441	Wayne Hansen	Black smoke coming out	
1444	CDC	Smoke is increasing in volume	
1444	CDC	Black smoke.	
1445	L24	continuing w/voice order for surrender no compliance.	
1445	HCSO	Window on <u>side 1</u> completely black cannot see in. Appears to be moving back	
1446	HCSO	towards # <u>2 side</u> .	
1447	CDC	Still black smoke getting worse.	
1447	CDC	NO flames, smoke <u>side 4</u> window B window A-black	
1449	67	A window <u>3 side</u> completely black	
1449	64	B window <u>4 side</u> something changing. something fell off window and now	
1449	64	it is changing color. NO movement	
1450	L24	Smoke at <u>4A + 4B</u> openings.	
1451	Garcia	Bishop radio is dead moving one to him. Side 2 main door - best view	
1451	Garca	Miller transporting radio	
1452	CDC	Black smoke side 4 windows A + B	

DEPARTMENT ACTION LOG

Date: 06/04/07

Page: 12

Incident #: _____

Time	Info Source	Chronological - Action/Information/Occurrences	Recorder
1455	L24	no change.	
1459	CDC	Smoke is getting darker and more intense.	
1500	CDC	movement side 4. ? - Glass fell out of window B. majority of smoke.	
1501	CDC	Side 3 window A lots of smoke.	
1502	Wayne Hansen	Sheriff notified.	
1503	CDC	<u>Side 3</u> , window B Smoke coming out	
1504	89	<u>Side 3</u> window B - Banging inside / CDC shots F poss inside	
1505	L24	<u>susp side 4 window B</u>	
1505	L24	Smoke intensifying. rounds cooking off or shots inside	
1506	49	2 attempts at gas I heard bumping inside side 2 window B.	
1507	T95	Smoke coming out of vent 2/3	
1509	T95	Roof vent 3 A/B vent	
1510	810	1/4 all along roof.	
1510	X10	NO VISUAL	
1511	L24	L24 A7 returning to TO C no visual	
1511		Team 2 has visual 1/2	
1511	CDC	lost all visual. Hearing fire crackle inside house. <u>Side 4</u>	
513	Team 2	2 thumps inside unk if fire related.	

DEPARTMENT ACTION LOG

Date: 060407

Page: 13

Incident #: _____

Time	Info Source	Chronological - Action/Information/Occurrences	Recorder
1513	67	no visibility # 3	
1513	Garcia	1/2 still clear	
1514	Garcia	No smoke out of side 2 window	
1515	CDC	Flames on 4 window A/B	
1515	mass	CDC with us. side 3	
1515	CDC	Flames side 3	
1516	49	Smoke purging window 2 (side 2)	
1516	49	Lost visibility in room. Poss in attic rolling down	
1517	CDC	Side 4 (Kitchen) totally involved	
1521	HCSO	Car parked in driveway 10 yds. from house	
1522	CDC	Fully involved - whole trailer	
1524	comm HCSO	(moving walking) fire trucks in to get other vens	
1524	Garcia	Smoke exiting front door.	
1527	X1	can you have someone run a can of paint down here.	
1527	164	EPD TK POSS has paint.	
1530	Team 2	Still no smoke # 1 or # 2	
1531	A9	check w/A1 see if there is a propane tank	
1532	unk HCSO	North # 3 side propane tank	
532	unk HCSO	5 gallon by stair # 1 side	

[REDACTED] **LOG**

Date: 060407

Page: 1

Incident #: _____

Code Violations	[REDACTED]

Time	Info Source	Chronological - Action/Information/Occurrences	Recorder
0304	HCSO	[REDACTED] stated "Bring the flashlight to me!"	[REDACTED]
0318	HCSO Bishop	Shining a flashlight	[REDACTED]
0413	49	L24 we have extensive movement on what we believe is the 2-side of the house	[REDACTED]
0454	L24	movement B window	[REDACTED]
0455	L24	All units we have movement 4-side window B. 4-side window B.	[REDACTED]
0457	L24	movement 4-side opening B-boy. 4-side opening B-boy	[REDACTED]
0510	unit	pure static. (Due to L24 saying we movement returned opening-B	[REDACTED]
0500	unit	4-side) possibly advisement of movement at a different location.	[REDACTED]
0501	L24	We got light B-opening 4-side. 4-side B-opening.	[REDACTED]
0509	L24	Appears lights are out in the house at this point.	[REDACTED]
1135	X10	Broken window 1 side	[REDACTED]
1136	Bishop.	movement in the 2 side window bedroom susp crawling on the ground.	[REDACTED]
1238	unit	Broad casts ceased	L24
1253	83 L23 Bishop	All heard noise on 2/3 side. Banging. Bishop-movement side 2 susp uncovered	[REDACTED]
1253	"	himself with a large blanket	[REDACTED]
1324	X10	Large hand gun seen on shelf Side 4 window A	[REDACTED]

Tue Jun 5 11:41:42 2007

CFS REPORT

ZONES: MC SHERIFFS OFFICE, MCSO PATROL GROUP, MC BEAT 42
 CFS NUMBER: 060307-123 DATE/TIME REC'D: 06/03/07 14:04
 CASE NUMBER: 200703162 DATE/TIME SENT: 06/03/07 14:09
 INC CODE: WELF DESC: WELFARE CHECK DATE/TIME CMPL: 06/04/07 16:17

INC ADDR: BALD HILLS RD and PINE CRE APT#: CITY: HOOPA PH#:
 COMP NAME: TRIBAL POLICE COMP ADDR: PH#:
 IN PROG: OFF CONT: PRI: 2 WEAPON: ALARM: PRI UNIT: Q40
 CALLTAKER: DISPATCHER:
 FINAL DISP:

UNITS ATTACHED: X25 2504 Q12 22A1 G10

COMMENTS: 06/04/07 16:57 11K4 NOTIFIED
 06/04/07 16:56 KIRKPATRICK REQUESTING CORONER
 06/04/07 16:23 CFS CLOSED IN ERROR. DISREGARD THE CLOSING TIME OF 16:17
 06/04/07 16:12 A7 REQUESTS OF DOJ PHONE HIM ON HIS CELL. MSG DELIVERED.
 06/04/07 15:45 HOUSE IS FULLY INVOLVED IN FIRE, UNITS ARE STILL STAGED WAITING
 06/04/07 14:45 FIRE ON SCENE. FIRE PERSONNEL ON SCENE
 06/04/07 14:44 CODE 33
 06/04/07 11:32 PER CP CODE 33
 06/04/07 11:23 PER D11, GAS IS BEING USED NOW
 06/04/07 10:41 CAVINTA NOTIFIED
 06/04/07 10:39 IF NEEDED THEY WILL TRY TO GET SOMEONE THERE AS SOON AS POSSIBLE.
 06/04/07 10:39 AIR OPS ADVISES THEY WILL NOT BE ON STAND BY DUE TO THE NATURE OF THE CALL.
 06/04/07 10:36 AIR OPS FOR CHP INQUIRING IF AIR SUPPORT IS NEEDED TODAY.
 06/04/07 06:08 A9 EN WITH PELICAN BAY NEGOTIATORS
 06/04/07 05:38 A9 MEETING WITH PELICAN BAY NEGOTIATORS AT MCK STATION SHORTLY
 06/03/07 23:18 X15 TOOK EQUIPMENT TO EPD . EPD SWAT WILL BE EN TO RELIEVE SET TEAM
 06/03/07 22:22 K25 AT WILLOW CREEK
 06/03/07 22:11 HISLOP AND DUNN EN
 06/03/07 21:50 PER A6, CANCEL CODE33
 06/03/07 21:05 ALL UNITS CODE 4 AND ACCOUNTED FOR, CONTINUING C33 PER A7
 06/03/07 20:55 SHOTS FIRED PER A7, CODE33 ISSUED PER A7
 06/03/07 20:39 CANCEL CODE 33 PER A7
 06/03/07 20:30 K25 ADVISES K25 WILL BE CLEARING SHORTLY FROM HIS RES
 06/03/07 19:36 CORRECTION Y1043 EN FROM HIS RES AT 1927HRS, Y1043 HAD BEEN OUT OF TOWN
 06/03/07 19:27 Y1083 EN FROM HIS RES, WAS OUT OF TOWN
 06/03/07 19:16 S/V ADVISED
 06/03/07 19:16 CORRECTION, HAVE SOMEONE FROM CONTACT A6 ON CELL PHONE
 06/03/07 19:15 PER A7 KEEP CODE33 IN EFFECT FOR NOW
 06/03/07 19:15 PER A6 HAVE SOMEBODY FAMILIAR WITH SUBJECT PHONE A6'S CELL PHONE
 06/03/07 19:08 NO PHONE CONTACT WITH ,NEGOTIATIONS ON THE PA BY FRIDLEY AND DANIELS
 06/03/07 18:42 PER D11 THERE WERE SHOTS FIRED BY (3 SHOTS) AND LAW ENFORCEMENT RETURNED FIRE UNK HOW MANY SHOTS
 06/03/07 18:34 L12 STILL EN, ETA OF DRIVE TIME FROM WILLOW CREEK
 06/03/07 18:32 COPIED CHP SCANNER TRAFFIC, 2 TRIBAL PATROL VEHICLES WERE

Tue Jun 5 11:41:42 2007

SHOT BY [REDACTED] HAS NOW CLOSED WINDOW AND STOPPED SHOOTING

06/03/07 18:27 Y599 EN CODE3

06/03/07 18:26 UNABLE TO REACH L11 ON RADIO

06/03/07 18:26 HAVE L11 EXPEDITE PER X10

06/03/07 18:26 SHOTS FIRED PER X1

06/03/07 18:22 96 TO LOOP RD TO PINE CREEK, FOLLOW PINE CREEK ALL THE

WAY

BACK TO BALD HILLS RD, ON BALD HILLS RD "ALL THE WAY BACK" THERE IS SHERIFFS
TAPE

MARKING LOCATION (PER TRIBAL)

06/03/07 17:21 L12 CLEAR WITH COMMAND POST EN HOOPA

06/03/07 17:01 L12 PAGED

06/03/07 17:01 SGT QUENELL REQ THE COMMAND VAN RESPOND TO THE SCENE

06/03/07 16:49 MARKED ENTERENCE TO RD WITH SHERIFF'S TAPE

06/03/07 16:27 [REDACTED] ON PORCH STILL POINTING RIFLE

06/03/07 16:20 FLOOR PLAN OF THE RESIDENCE CREATED BY HOME OWNER.

06/03/07 16:17 X3'S FROM EAST FORK CAMPGROUND

06/03/07 16:17 [REDACTED] CONTINUALLY POINTING FIREARM AT UNITS.

06/03/07 16:02 ISSUED SET CALL OUT.

06/03/07 16:02 MOVE ANY SUVILLIANS OUT OF THE AREA.

06/03/07 16:00 VEHICLE OUT OF DRIVEWAY, APOX 200 FT FROM THE RESIDENCE.

06/03/07 16:00 [REDACTED] ADVISED HE [REDACTED] AND HAS BEEN THERE

MULTIPLE
TIMES.

06/03/07 15:58 PER Q40 HE HAS TO SNEAK TO USE THE RADIO, SCANNER

TRAFFIC

06/03/07 15:57 LT KNIGHT, REQ A SET CALLOUT, CAMO GEAR MEET AT MAIN

STATION

06/03/07 15:57 PER X3 RUN A RAP ON [REDACTED]

06/03/07 15:57 CALLING [REDACTED] TO GET HISTORY

06/03/07 15:55 DR number 200703162 assigned for agency HUMBOLDT CO

SHERIFF

06/03/07 15:55 [REDACTED] IS COCKING (SP) THE GUN

06/03/07 15:54 Q14 RESPONDING EAST W/ SET GEAR.

[cfsd] 06/03/07 15:53 Cross Streets : PINE CREEK RD * BLOODY CAMP RD

06/03/07 15:53 Inc Address changed to BALD HILLS RD and PINE CREEK RD at
15:53

06/03/07 15:52 PER Q40 [REDACTED] ALSO HAS A HAND GUN.

06/03/07 15:52 PER X3 GET A BETTER PERIMETER WHEN MORE UNITS ARE ON

SCENE.

06/03/07 15:52 PER X3 WOULD OFF THE AIR SUPPORT

06/03/07 15:50 CONFIRMED [REDACTED] STILL IN THE 22 W/ A SCOPE,

06/03/07 15:48 RED BANDANA, BLU JEANS, WET SUIT, TOP IS SLEEVELESS.

06/03/07 15:47 REQUEST TRIBAL UNITS DOLO FOR THE [REDACTED] THIN BLK

FACIAL

HAIR

06/03/07 15:46 NO LONGER SEE [REDACTED] IN RES ANYMORE, BACK DOOR THAT HE
POSSIBLY WENT OUT WITH, FACIAL HAIR BLK

06/03/07 15:45 CORRECTION: UNABLE

06/03/07 15:45 X1 IS ANABLE TO RESPOND, HE HAS HIS SON WITH HIM

06/03/07 15:40 PER X3 CALL OUT X1.

06/03/07 15:40 DUTY OFFICER NOTIFIED.

06/03/07 15:37 CHP IS 20-25 MINS OUT

06/03/07 15:35 WEAPONS IN THE RESIDENCE. UNK IF WEAPONS ARE LOADED.

06/03/07 15:35 ONLY OCCUPANT IN THE RESIDENT.

06/03/07 15:33 PER 2505 CALL OUT ADDITIONAL UNITS FOR TRIBAL.

06/03/07 15:33 CODE 33 POSTED

06/03/07 15:33 [REDACTED] POINTING A FIREARM AT DEPUTIES. REQUEST UNITS

EXPEDITE.

06/03/07 15:31 CHP WILL BE ENROUTE

06/03/07 15:30 REQUEST CHP FOR AN ADDITIONAL UNIT

06/03/07 15:29 [REDACTED] IN POSSESSION OF SEVERAL KNIVES REFUSING TO PUT
THEM DOWN, REQUEST 2505 EXPEDITE

Tue Jun 5 11:41:42 2007

lesh 06/03/07 14:31 [REDACTED] TOLD MOTHER OF DREAM HE HAD TO KILL MOTHER'S YOUNG CHILD

[REDACTED] 06/03/07 14:31 2505 SPOKE W [REDACTED] MOTHER THIS MORNING, SHE ADV VERY [REDACTED]

[REDACTED] 06/03/07 14:30 2505 ADV JUST RELEASED FROM [REDACTED] WHILE THERE BECAME VIOLENT AND WAS MOVED TO HCCF

[REDACTED] 06/03/07 14:14 [REDACTED] ARE IN [REDACTED] TRAILER

[REDACTED] 06/03/07 14:14 RIGHT BEFORE WHI CROSS ON LEFT HAND SIDE, TWO WIII POSTS THAT SAY [REDACTED] TURN THERE

[REDACTED] 06/03/07 14:06 HOUSE IS LOCATED ON [REDACTED] PROPERTY

[REDACTED] 06/03/07 14:06 ORIGINAL RP JACKIE [REDACTED]

[REDACTED] 06/03/07 14:05 SUBJ IS STAYING WITH [REDACTED]

[REDACTED] 06/03/07 14:05 CHECK [REDACTED] IS [REDACTED]

[REDACTED] 06/03/07 14:05 RELAYED THROUGH TRIDAL POLICE

[REDACTED] 06/03/07 14:05 LITTLE HOUSE, UNK FURTHER DESCRIPTION

[REDACTED] 06/03/07 14:04 JUST BEFORE WHI CROSS ON BALD HILL RD, TAKE A LEFT

[REDACTED]

[REDACTED]

SOC: AGE: HGT: WGT: DOB: RAC: SEX: HAI: EYE:

ARMED & DANGEROUS?

LSW:

MISCELLANEOUS:

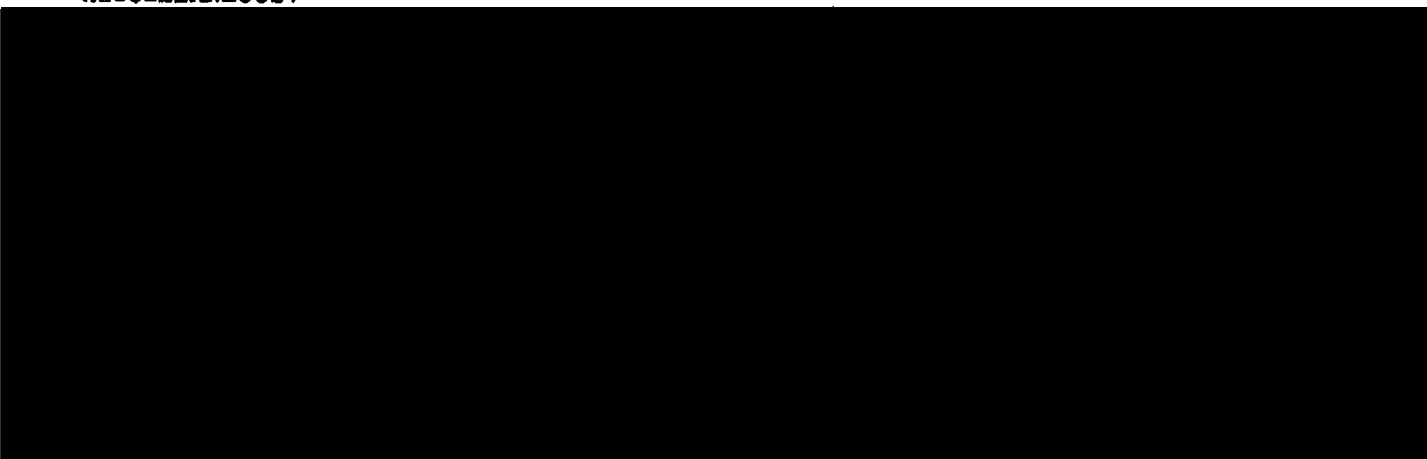

RUNTIMES ASSOCIATED WITH CALL:

UNIT	SURUNIT	STATUS	TIME
11K4		DISP	16:56
		EN_ROUTE	17:21
		OUT_SCENE	18:46
22A1		AVAIL	19:47
		DISP	06:45
		EN_ROUTE	06:45
2402		OUT_SCENE	09:28
		DISP	14:10
		EN_ROUTE	14:10
2406		OUT_SCENE	15:02
		CODE4	15:12
		OUT_SCENE	15:26
		AVAIL	00:28
		DISP	15:42
2408		EN_ROUTE	15:43
		OUT_SCENE	16:13
		AVAIL	01:19
2408		DISP	15:42

Tue Jun 5 11:41:42 2007

		EN_ROUTE	15:43
		OUT_SCENE	16:13
2503		AVAIL	01:19
		DISP	16:05
		EN_ROUTE	16:05
		OUT_SCENE	16:05
2504		AVAIL	01:03
		DISP	16:05
		EN_ROUTE	16:05
		OUT_SCENE	16:05
		CODE4	16:05
		OUT_SCENE	16:05
		OUT_SCENE	17:03
		AVAIL	03:40
		DISP	22:49
2505		OUT_SCENE	22:49
		DISP	15:29
		EN_ROUTE	15:29
		OUT_SCENE	16:05
25A1		AVAIL	03:41
		DISP	16:01
		EN_ROUTE	16:05
		OUT_SCENE	16:05
7K1		AVAIL	03:41
		DISP	00:04
		EN_ROUTE	00:04
		OUT_SCENE	00:04
		AVAIL	16:17
		DISP	16:17
		OUT_SCENE	16:18
7K5		AVAIL	21:28
		DISP	00:03
		EN_ROUTE	00:04
		OUT_SCENE	00:04
		AVAIL	16:17
		DISP	16:17
		OUT_SCENE	16:18
		AVAIL	20:56
A2		EN_ROUTE	16:46
		DISP	16:46
		OUT_SCENE	17:48
		AVAIL	20:55
A6	KNIGHT	DISP	16:24
		EN_ROUTE	16:24
		OUT_SCENE	16:32
		EN_ROUTE	17:16
		OUT_SCENE	18:52
		AVAIL	00:57
A7	CAVINTA	DISP	16:43
		EN_ROUTE	16:43
		OUT_SCENE	20:04
		AVAIL	16:17
		DISP	16:22
		OUT_SCENE	16:23
		AVAIL	18:15
A9	MOREY	DISP	06:08
		EN_ROUTE	06:08
		OUT_SCENE	11:11
		AVAIL	16:17
		DISP	16:17
		OUT_SCENE	16:18
		AVAIL	16:29
D11		DISP	17:25

Tue Jun 5 11:41:42 2007

		EN_ROUTE	17:25
		OUT_SCENE	20:04
		OUT_SCENE	05:04
		OUT_SCENE	11:11
D13		AVAIL	16:17
		DISP	17:22
		EN_ROUTE	17:22
		OUT_SCENE	18:31
G10		AVAIL	00:57
		OUT_SCENE	08:22
K25		DISP	08:22
		DISP	21:09
		EN_ROUTE	22:22
		OUT_SCENE	03:41
		AVAIL	05:03
		DISP	05:04
		OUT_SCENE	05:04
		OUT_SCENE	11:11
K27		AVAIL	16:17
		DISP	16:40
		EN_ROUTE	16:42
		OUT_SCENE	20:04
		AVAIL	05:03
		DISP	05:04
		OUT_SCENE	05:04
		OUT_SCENE	11:11
K28	KIRKPATRIC	AVAIL	16:17
		DISP	07:30
		EN_ROUTE	07:30
		OUT_SCENE	10:29
L11		AVAIL	16:17
		DISP	16:17
		EN_ROUTE	16:17
		AVAIL	17:15
		DISP	17:15
		EN_ROUTE	17:15
		OUT_SCENE	18:27
		AVAIL	18:39
		DISP	05:00
		OUT_SCENE	05:00
		AVAIL	05:03
		DISP	05:04
		OUT_SCENE	05:04
		OUT_SCENE	11:11
		AVAIL	16:17
		DISP	16:17
		OUT_SCENE	16:10
L12	DAASTOL	AVAIL	18:08
		DISP	17:21
		EN_ROUTE	17:21
		OUT_SCENE	20:32
L13		AVAIL	05:03
		DISP	17:21
		EN_ROUTE	17:21
		OUT_SCENE	20:32
		AVAIL	05:03
L66	PETERSON_M	DISP	22:49
		OUT_SCENE	22:50
		AVAIL	09:27
Q12	DIEMER	DISP	06:14
		EN_ROUTE	06:14
		EN_ROUTE	06:14
		EN_ROUTE	06:43

Tue Jun 5 11:41:42 2007

Q14		OUT_SCENE	08:47
		DISP	15:54
		EN_ROUTE	16:06
		OUT_SCENE	08:58
		AVAIL	16:17
		DISP	16:18
		OUT_SCENE	16:19
Q40	BERRY_G	AVAIL	18:11
		DISP	14:10
		EN_ROUTE	14:10
		OUT_SCENE	15:02
		CODE4	15:12
		OUT_SCENE	15:26
S18		AVAIL	00:28
		DISP	17:58
		EN_ROUTE	17:58
		OUT_SCENE	20:04
		AVAIL	05:03
		DISP	05:04
		OUT_SCENE	05:04
		OUT_SCENE	11:12
		AVAIL	16:17
		DISP	16:17
		OUT_SCENE	16:18
S45		AVAIL	16:47
		DISP	17:02
		EN_ROUTE	17:02
		OUT_SCENE	17:19
X1	FRIDLEY	AVAIL	21:58
		DISP	17:00
		PREWATCH	17:00
		OUT_SCENE	18:29
		AVAIL	03:52
		DISP	08:41
		OUT_SCENE	08:41
		AVAIL	16:17
		DISP	16:17
		OUT_SCENE	16:19
X10		AVAIL	17:16
		DISP	17:23
		EN_ROUTE	17:23
		OUT_SCENE	18:29
		AVAIL	05:03
		DISP	05:04
		OUT_SCENE	05:04
		OUT_SCENE	11:11
		AVAIL	16:17
		DISP	16:17
		OUT_SCENE	16:19
X15	BUIHNER	AVAIL	18:16
		DISP	05:44
		EN_ROUTE	06:09
		OUT_SCENE	10:29
		AVAIL	16:17
		DISP	16:17
		OUT_SCENE	16:19
X25	HANSON	AVAIL	11:00
		DISP	06:58
		EN_ROUTE	07:29
		OUT_SCENE	10:29
		AVAIL	16:17
		DISP	16:18
		OUT_SCENE	16:18

Tue Jun 5 11:41:42 2007

X3

DISP 15:36
EN_ROUTE 15:36
OUT_SCENE 16:48

Y1004

AVAIL 16:17
DISP 17:23
EN_ROUTE 17:23
OUT_SCENE 18:29
AVAIL 05:03

DISP 05:04
OUT_SCENE 05:04
OUT_SCENE 11:11
AVAIL 16:17

Y1026

DISP 16:17
OUT_SCENE 16:19
AVAIL 18:16

DISP 16:33
EN_ROUTE 16:33
OUT_SCENE 17:09
AVAIL 05:03

DISP 05:04
OUT_SCENE 05:04
OUT_SCENE 11:11
AVAIL 16:17

DISP 16:18
OUT_SCENE 16:18
AVAIL 17:39

DISP 18:59
ENRT_HOSP 18:59
OUT_HOSP 19:26

Y1043

AVAIL 19:50
DISP 19:29
EN_ROUTE 19:29

OUT_SCENE 20:04
EN_ROUTE 20:04
OUT_SCENE 03:41

AVAIL 05:03
DISP 05:04
OUT_SCENE 05:04

OUT_SCENE 11:11
AVAIL 16:17
DISP 16:18

OUT_SCENE 16:18
AVAIL 17:39
DISP 17:03

Y1066

AVAIL 17:20
DISP 17:20
EN_ROUTE 17:20

OUT_SCENE 18:31
AVAIL 03:58
DISP 17:41

Y1078

AVAIL 17:58
DISP 17:58
EN_ROUTE 17:58

OUT_SCENE 20:04
AVAIL 05:03
DISP 05:04

OUT_SCENE 05:04
OUT_SCENE 11:12
AVAIL 16:17

DISP 16:17
OUT_SCENE 16:18
AVAIL 16:47

DISP 17:04

Tue Jun 5 11:41:42 2007

Y1082

OUT_SCENE 17:04
 AVAIL 17:39
 DISP 17:15
 EN_ROUTE 17:15
 OUT_SCENE 20:04
 AVAIL 05:03
 DISP 05:04
 OUT_SCENE 05:04
 OUT_SCENE 11:11
 AVAIL 16:17
 DISP 16:18
 OUT_SCENE 16:18

Y1083

AVAIL 17:35
 DISP 17:15
 EN_ROUTE 17:15
 OUT_SCENE 18:27
 AVAIL 18:39
 DISP 18:41
 EN_ROUTE 19:27
 AVAIL 19:29
 DISP 20:03
 EN_ROUTE 20:04
 OUT_SCENE 20:04
 AVAIL 05:03
 DISP 05:04
 OUT_SCENE 05:04
 OUT_SCENE 11:11

Y1085

AVAIL 16:17
 DISP 16:18
 OUT_SCENE 16:10
 AVAIL 17:39
 DISP 17:15
 EN_ROUTE 17:15
 OUT_SCENE 20:04
 AVAIL 05:03
 DISP 05:04
 OUT_SCENE 05:04
 OUT_SCENE 11:12
 AVAIL 16:17
 DISP 16:18
 OUT_SCENE 16:18

Y599

AVAIL 17:39
 DISP 18:13
 EN_ROUTE 18:13
 OUT_SCENE 19:16
 AVAIL 05:03
 DISP 05:04
 OUT_SCENE 05:04
 OUT_SCENE 11:11
 AVAIL 16:17
 DISP 16:18
 OUT_SCENE 16:18
 AVAIL 17:53

Schlesiger, Rich

From: Schlesiger, Rich
ent: Thursday, June 21, 2007 9:20 AM
To: Barney, Jamie; Massaro, Blake; Taylor, Jesse A
Subject: Hoopa

Gentlemen, I need to speak to you guys again about the Hoopa incident. It is regarding the 2nd day of the operation and the deployment of the gas. I know some of you are on days off and I just found out that Blake has weekends off. I called and left messages at your homes as you probably know. For Jesse and Jamie, if I don't hear from you guys on Thursday or Friday I would like to do your follow up interviews next week on you days off. Blake, give me a call so I can see what we can arrange. I have already spoke to B. Quenell and B. Taylor.

Thanks, Rich



Schlesiger, Rich

From: Barney, Jamie
Sent: Thursday, June 21, 2007 6:01 PM
To: Schlesiger, Rich
Subject: RE: Hoopa

Tuesday I will be working O.T. in Court, I'm sure I can come downstairs to talk to you then, I'll call you on Tuesday
J.Barney

-----Original Message-----

From: Schlesiger, Rich
Sent: Thursday, June 21, 2007 9:20 AM
To: Barney, Jamie; Massaro, Blake; Taylor, Jesse A
Subject: Hoopa

Gentlemen, I need to speak to you guys again about the Hoopa incident. It is regarding the 2nd day of the operation and the deployment of the gas. I know some of you are on days off and I just found out that Blake has weekends off. I called and left messages at your homes as you probably know. For Jesse and Jamie, if I don't hear from you guys on Thursday or Friday I would like to do your follow up interviews next week on you days off. Blake, give me a call so I can see what we can arrange. I have already spoke to B. Quenell and B. Taylor.

Thanks, Rich



Schlesiger, Rich

From: Massaro, Blake
Sent: Thursday, June 21, 2007 11:52 PM
To: Schlesiger, Rich
Subject: RE: Hoopa

Rich,
Played phone tag with you today (Thurs.). I'm available any time. I do work graveyards during the week, so an afternoon interview would be better. I will give you a call tomorrow (Fri.) to see what we can arrange.

~Blake

-----Original Message-----

From: Schlesiger, Rich
Sent: Thursday, June 21, 2007 9:20 AM
To: Barney, Jamie; Massaro, Blake; Taylor, Jesse A
Subject: Hoopa

Gentlemen, I need to speak to you guys again about the Hoopa incident. It is regarding the 2nd day of the operation and the deployment of the gas. I know some of you are on days off and I just found out that Blake has weekends off. I called and left messages at your homes as you probably know. For Jesse and Jamie, if I don't hear from you guys on Thursday or Friday I would like to do your follow up interviews next week on your days off. Blake, give me a call so I can see what we can arrange. I have already spoke to B. Quenell and B. Taylor.

Thanks, Rich





ARCATA POLICE DEPARTMENT

736 F St., Arcata, CA 95521
 (707) 822-2428
 (707) 822-7936 Fax

HATE CRIME

DOMESTIC VIOLENCE

VICTIM CONFIDENTIALITY PER 293 PC

PAGE 1	CASE NUMBER 07-1450
-----------	------------------------

ADDITIONAL PERSONS INVOLVED

INCIDENT	CODE SECTION(S)	DESCRIPTION	CLASSIFICATION
		OUTSIDE ASSIST	RECEIVED
		HUMBOLDT COUNTY SHERIFF'S DEPARTMENT	JUN 08 2007
			DISTRICT ATTORNEY
	DATE / TIME REPORTED 6/5/2007 0730	DATE / TIME OCCURRED 6/4/2007	LOCATION [REDACTED] RD HOOPA CA
			AREA

VICTIMS, WITNESSES, OTHERS	ROLE	NAME (L,F,M)					ALIAS
	RACE	SEX	AGE	DOB	OTHER INFORMATION		
	ADDRESS						TELEPHONE NO.
	VEHICLE COLOR	YEAR	MAKE	BODY STYLE	LICENSE / STATE		
	ROLE	NAME (L,F,M)					ALIAS
	RACE	SEX	AGE	DOB	OTHER INFORMATION		
	ADDRESS						TELEPHONE NO.
	VEHICLE COLOR	YEAR	MAKE	BODY STYLE	LICENSE / STATE		
	ROLE	NAME (L,F,M)					ALIAS
	RACE	SEX	AGE	DOB	OTHER INFORMATION		
	ADDRESS						TELEPHONE NO.
	VEHICLE COLOR	YEAR	MAKE	BODY STYLE	LICENSE / STATE		

INFO	IF ASSAULT: VICT.# TYPE OF WEAPON DESCRIPTION OF INJURY
	IF COMMERCIAL OR RESIDENTIAL BURGLARY, ENTER TYPE OF STRUCTURE

SUSPECTS	ROLE	NAME (L,F,M)					ALIAS				
	RACE	SEX	AGE	DOB	HT.	WT.	HAIR	EYES	DL / ID	OTHER	
	ADDRESS									TELEPHONE NO.	
	VEHICLE COLOR	YEAR	MAKE	BODY STYLE	LICENSE / STATE						
	OTHER INFORMATION										
	ROLE	NAME (L,F,M)					ALIAS				
	RACE	SEX	AGE	DOB	HT.	WT.	HAIR	EYES	DL / ID	OTHER	
	ADDRESS									TELEPHONE NO.	
	VEHICLE COLOR	YEAR	MAKE	BODY STYLE	LICENSE / STATE						
	OTHER INFORMATION										

CONTROLLED DOCUMENT
 DUPLICATION OR REISSUANCE
 CONTROLLED BY LAW

Released to: DA + Mr. Hensal

Arcata Police Department

OFFICER SILVERS, SGT	ID NO. 482	DATE REPORT SUBMITTED 6-7-07	SUPERVISOR REVIEW BS	DATE 6-7-07	ASSOCIATED REPORT NUMBER(S)
--------------------------------	----------------------	----------------------------------------	--------------------------------	-----------------------	-----------------------------

CITY OF ARCATA
POLICE DEPARTMENT

2

AGENCY ASSIST

C.I.R.T

On 6/5/07 at about 0730 hrs, I was called by Sergeant Sligh who informed me that the Critical Incident Response Team had been initiated and requested that I respond to the Humboldt County Sheriff's Office. I arrived at about 0830 and was briefed on the incident that occurred on Bloody Camp Rd on 6/3/07.

Humboldt County District Attorney Investigator Honsal and I were tasked with obtaining statements from the Eureka Police Department SWAT team members who had provided support for the Humboldt County Sheriff's Department during the incident.

EUREKA POLICE SERGEANT MIKE JOHNSON

Investigator Honsal and I met with Eureka Police Department Sergeant Mike Johnson at about 1120 hrs at the Eureka Police Department. The interview was audio recorded with his knowledge and consent. The following is a summary of his statement.

Sergeant Johnson stated that he was getting ready for his regular shift at about 2100 hrs when he received a page. The page requested that he call EPD Sergeant Nova about a SWAT callout. Sergeant Johnson called Nova and was informed that HSCO had requested an agency assist for them to relieve the HCSO SWAT team who was dealing with a barricaded [REDACTED] in Hoopa. Sergeant Nova requested that he be ready to leave the department at about 0030 hrs.

Prior to leaving for Hoopa, the EPD SWAT team was briefed by Sergeant Nova. The briefing included the [REDACTED] name [REDACTED] [REDACTED] [REDACTED] and background information including a contact between EPD Sergeant Armstrong and [REDACTED]. The contact involved a felony vandalism arrest a week earlier. They were also informed that [REDACTED] was known [REDACTED] to be confrontational with law enforcement. They also obtained a recent booking photo of [REDACTED]. Prior to briefing, Sergeant Johnson went to his residence to get some equipment and heard on the scanner that [REDACTED] had fired for a second time at Deputies on scene.

EPD arrived on scene at about 0200 hrs. They were briefed and informed that the team was going to split up and they were assigned to the perimeter. They were again informed that the deputies had been fired upon and advised about the layout of the scene. They were then led by pairs to their assigned areas. Their mission was to hold the perimeter.

Sergeant Johnson was initially deployed along with three other EPD SWAT officers to a Hoopa Tribal SUV which was parked below and S/E of the residence (depicted as a circled x on attached sketch). They were assigned to watch the #4 side (south) of the building. The four officers would trade off in pairs between looking through the night

CONFIDENTIAL

CITY OF ARCATA
POLICE DEPARTMENT

3

AGENCY ASSIST

C.I.R.T

vision goggles (NVG's) and rifles. They could see a light that was on "pretty steadily" throughout the night in the 4B (south side of the residence) window which they assumed was the living room. They also noticed a light that was flickering in the 4A window (south side of the residence).

At one point Sergeant Johnson and Team Leader Officer Wilcox moved forward to the residence and took cover behind one of two pine trees near the residence (Position depicted as #1 on attached sketch) to get a better view of the layout of the residence. They maintained this position for approximately a half an hour. They saw some movement in the residence and it appeared to be only one person. There was no attempt to contact [REDACTED] nor did he make any statements. At about 9:00 a.m. three or four HCSO SWAT team members relieved Sergeant Johnson and the three other EPD SWAT team members.

At about 10:30 a.m. EPD was told that the HCSO was going to attempt communications again by the use of a throw phone or PA. EPD was going to assist with the perimeter and whatever other duties the HCSO needed.

After the attempts to communicate failed, the entire EPD SWAT Team was deployed to the #2 side (north side of the residence) to deploy gas. EPD took up a position approximately 81 yards north of the residence (depicted by an x on the top of attached sketch). Officers Jones and Altic fired gas canisters at the residence but at that distance it proved to be difficult. They had to fire several canisters before they were able to get the canisters inside the residence. Due to the angle that the team was at some of the gas rounds struck the building and bounced off. Sergeant Johnson and the rest of the EPD SWAT team provided cover for them.

After the gas was deployed Sergeant Johnson was able to see smoke in the residence. The wind was blowing from the #2 side toward the #4 side (north to south). Sergeant Johnson did not personally see [REDACTED] in the residence. He heard on the radio that deputies thought they saw the [REDACTED] inside with a blanket around him.

The HCSO deployed two volleys of hand canisters of gas into the front of the residence. "Some time" after the hand canisters were deployed Sergeant Johnson saw black smoke coming out of the #4 side (south) side of what he presumed was the attic area. The smoke was significantly different from the smoke generated by the deployment of gas canisters.

CONFIDENTIAL

A little while after seeing the black smoke he observed another change in the smoke to white. Sergeant Johnson likened it to firemen putting water on fire. He could also hear movement inside the residence.

CITY OF ARCATA
POLICE DEPARTMENT

4

AGENCY ASSIST

C.I.R.T

At no time during the incident did he hear anyone scream for help or say anything. From his position at the time the fire started Sergeant Johnson said he could have "easily" heard someone yell for help and been able to rescue that [REDACTED]. The windows to the residence had been broken and he could hear a dog barking from inside the residence. When the fire started Sergeant Johnson clearly heard Sergeant Friedly telling [REDACTED] over the PA that the house appeared to be on fire and that he needed to get out. When the residence was engulfed and the Fire Department was called in Sergeant Johnson left his position and returned to the Command Post. Sergeant Johnson was checked out by his team leader as well as a Humboldt County District Attorney Investigator and then left the scene. The interview ended at 1142 hrs.

EUREKA POLICE OFFICER GREG HILL

On 6/5/07 at about 1250 hrs, Humboldt County District Attorney Investigator Bill Honsal and I spoke with Eureka Police Officer Greg Hill at EPD. The interview was audio taped with his knowledge and consent. The following is a summary of his statement.

Hill stated that he was off duty at his residence at about 2030 hrs when he received a call from Sergeant Nova asking if he was available to assist the SWAT team with a barricaded [REDACTED]. Officer Hill is a member of the Eureka Police Department Patrol Rifle Team which functions as support for the SWAT team securing perimeters. He was instructed to be ready to leave the Eureka Police Department at 0030 hrs and to bring his handgun, patrol rifle and all other patrol rifle gear.

Prior to leaving EPD the team conducted a briefing where they were informed that Tribal Police had responded to a welfare check. When they arrived on scene they saw a [REDACTED] in front of the residence with a firearm. Tribal Police retreated back to a cover position. The [REDACTED] later fired on two vehicles and then again at deputies at which time they returned fire. They were also informed that the [REDACTED] had a [REDACTED] and that EPD had recent contacts with him. There were supposed to be several firearms inside the residence. The team was provided a description of the [REDACTED] and told that there appeared to be one [REDACTED] with a possibility of another inside the residence.

Once they arrived on scene they were briefed on the layout of the scene which included the position of the HCSO SWAT team members they would be relieving. Hill said that their role was support as well as to provide perimeter security for the residence through the night.

Hill stated he was initially deployed to the Tribal Police vehicle (depicted as #1 on the attached sketch) to cover the #4 side (south) of the residence. Both front doors of the

CITY OF ARCATA
POLICE DEPARTMENT

5

AGENCY ASSIST

C.I.R.T

vehicle were open and he initially started on the passenger's side of the vehicle and later moved to the driver's side. While on the driver's side, he acted as an observer using the Night Vision Goggles (NVG's) Without the NVG's Hill estimated that the visibility was about 25 feet. Hill had the NVG's on for about an hour and twenty minutes from 0400 to 0520. During this time he saw [REDACTED] walking back and forth in front of the 4B window (refer to attached sketch). Hill believes he was seeing a shadow but did not have a clear view of [REDACTED]

Hill stated that there was a "faint" light as well as what he assumed was the television flickering in the background. He described the light as possibly an oil lamp but assumed it was an electric light. At about 0500 all the lights went out in the residence and it was completely dark. By about 0520 hrs, daylight was breaking and the group felt their position was compromised. They moved back to HSCO and Tribal patrol vehicles that were parked about 20 yards (depicted as #2 on the attached sketch) behind them. At about 0730 the EPD officers were relieved by the HCSO SWAT officers and went to the Command Post to rest.

Throughout the night Hill could hear thumping inside the residence. He described it as sounding like someone being mad and hitting the wall. He also said that prior to putting the NVG's on he heard a muffled voice inside the residence. He could not understand what was being said and he cannot be completely sure that it was not another officer in the distance. Hill said it sounded like a shout and then a couple of other words. When he heard the noise he asked Officer Wilcox if he had heard it also. Officer Wilcox had also heard the noise but was unable to understand it. Hill believes that the PA announcements would have overridden the noise he heard in the residence.

Around 1000 hrs, Sergeant Nova instructed the EPD SWAT team to gear up and that they would be assisting the HSCO SWAT team with deploying gas. They re-deployed to the Tribal vehicle (depicted as #2 on the attached sketch) they were told to stand by. They stood by for about an hour while waiting for a medical helicopter to come into the area in case of injuries. During the hour HSCO continued attempting to make contact with [REDACTED] using the PA system. Prior to attempting contact, they initiated a siren from one of the vehicles to get [REDACTED] attention.

After about an hour the order was given for the HSCO to begin deploying gas. Hill could not actually see the gas being deployed but could hear the canisters being launched. After the first set of canisters, EPD was requested to make their way to the #2 side (north side of residence) and begin deploying gas. Officer Hill along with Officers Wilcox, Cooper, Jones, Altic and Sergeant Johnson made their way to the #2 side of the residence (depicted as #3 on the attached sketch).

CONFIDENTIAL

CITY OF ARCATA
POLICE DEPARTMENT

6

AGENCY ASSIST

C.I.R.T

The closest they could get to the residence was approximately 81 yards due to lack of cover. Hill was instructed to provide support for other officers while they deployed gas into the residence. It appeared as if [REDACTED] was somewhat barricading the window on the #2 side of the house. Hill was unable to clearly see what was partially covering the window. He thought it was similar to wood paneling that is commonly hung on the wall.

Officers Jones and Altic fired gas at the window on the #2 side of the residence. Officer Hill saw about seven canisters enter the window. He could not see the gas once it entered through the window due to his gas mask fogging up. He didn't see or hear anyone inside the residence. After about 15 min in this location it was requested that EPD respond to the #3 side (east side of the residence) and attempt to deploy gas through the windows and door located there. Officer Hill along with Officer's Wilcox, Jones and Altic moved to the #3 side (depicted as #4 on the attached sketch).

They took cover behind an oak tree on the east side of the residence. Once in position they advised SWAT command that they were in position and fired a volley of gas through the two windows on the #3 side of the residence. Hill estimated they were approximately 50-60 yards from the residence at that time. Due to Officer Hill's position and the fact that it was dark inside the building he couldn't get a complete view of the 3A window (refer to attached sketch). The 3B window was covered with wood. Officer Hill could hear the HSCO on the PA attempting to make contact with [REDACTED]. He did not hear or see any movement inside the residence. From his location, Officer Hill stated that he could have heard anyone yelling for help or wanting to give up from inside the residence.

Officer Hill saw the HSCO approach the #4 side (south side of residence) on foot and deploy hand canisters into the residence through the windows. He could see the gas began to fill the residence. The wind had shifted and he could smell the gas so he and the other officers deployed their gas masks at that time. After a while, Officer Hill noticed that the gas had dissipated out the front windows and the inside of the residence was clearing up.

About 10-15 minutes after the last canisters were thrown and the inside of the residence appeared to be completely cleared out, Hill began to see black smoke coming from the peak on the front side. The smoke was different than the smoke from the gas deployment. The wind had shifted and it smelled like something burning. At that point Hill believed the residence was on fire. Someone on the radio also said it appeared that the residence was on fire.

There was ample time for someone to get out of the residence before it filled with smoke. The windows on the #3 side could have been used as a way out. It also appeared that the door on the #3 side could have been used as an exit. From his

CONFIDENTIAL

CITY OF ARCATA
POLICE DEPARTMENT

7

AGENCY ASSIST

C.I.R.T

position Hill could have heard someone yelling for help or surrendering and would have been able to perform a rescue. He could hear the HSCO announcing on the PA that the building was on fire and that [REDACTED] needed to come out and that he would not be hurt. [REDACTED] continuously encouraged to get out of the house.

The only change Hill observed was when the black smoke was starting to build up initially there was a "plume" or "instant puff" of white smoke. Hill said it reminded him of throwing water on a campfire. Hill estimated it about 45 minutes for the fire to go through the building. If there was anyone in the residence Hill believes he would have heard them. Based on the wind change and the fact that they learned the residence's propane tanks may be on the #3 side they moved back from their original position (depicted as #5 on the attached sketch). By the time Hill left his position the fire had fully engulfed both windows on the #3 side but had not made it to the door on the #3 side.

Hill heard some "muffled thumps and pops" and what he believed to be a box of ammunition igniting inside the residence. Hill then left the area and returned to the Command Post. He was checked out by a team leader as well as a Humboldt County District Attorney Investigator and left the scene.

The interview ended at 1335 hrs.

I created two copies of Sergeant Johnson and Officer Hill's interview onto CD. I booked a copy of each into evidence at APD and sent the second copy along with this report to the Humboldt County Sheriff's Department to be included with their report.

DISPOSITION: CLOSED

CONFIDENTIAL



ARCATA POLICE DEPARTMENT
 736 F Street, Arcata CA 95521
 (707) 822-2428, (707) 822-7936 Fax

PAGE NO.	CASE NO.
8	07-1450

EVIDENCE / PROPERTY

EVIDENCE PROPERTY

PROPERTY SEIZED DURING THE SERVICE OF A SEARCH WARRANT

R - RESPONSIBLE V - VICTIM S - [REDACTED]

ROLE	NAME (L,F,M)	OTHER INFO
[REDACTED]	[REDACTED]	[REDACTED]
ADDRESS	TELEPHONE NO.	
[REDACTED]	[REDACTED]	

E - EVIDENCE F - FOUND K - SAFEKEEPING R - RECOVERED S - STOLEN

CODE	ITEM #	DESCRIPTION	SERIAL NUMBER	DISPO / VALUE
E	1	CD CONTAINING EPD SERGEANT JOHNSON'S STATEMENT	[Barcode] APD 00007350	APD
E	2	CD CONTAINING EPD OFFICER HILL'S STATEMENT	[Barcode] APD 00007351	APD

CONFIDENTIAL

OFFICER	ID NO.	ADDITIONAL / ASSOCIATED CASE NUMBERS
SILVERS, SGT	482	

HUMBOLDT COUNTY SHERIFF'S DEPARTMENT

CASE: 200703162

INTERVIEWER: Bill Honsal, D.A. Investigator



STATEMENT OF: Sergeant Mike Johnson

DATE & TIME: 6/5/2007 @ 11:20 AM.

LOCATION:

ALSO PRESENT: Bart Silvers, A.P.D.

BH Bill Honsal
MJ Mike Johnson
BS Bart Silvers

BH Okay um, Bill Honsal, uh with the District Attorney's Office, Bart Silvers with A.P.D. interviewing Mike Johnson, it's six five (6/5) um and it's eleven twenty (011:20) in the morning and uh Mike Johnson is present, spell your last name Mike?

MJ J-O-H-N-S-O-N.

BH Um so we're, we're talking about the uh, the incident that occurred up on um, off of Bloody Camp road, uh there was an assist made by E.P.D. SWAT uh to go out there on uh the third (3rd) of June or I guess the morning of the fourth (4th) of June um, can you tell me uh where you were when you got the call?

MJ Uh I was at work actually I start my watch at nine (9) P.M. actually technically eight thirty (8:30) for briefing.

BH Uh huh.

MJ And I had just uh got my uniform on and my gear on and I was headed down to do briefing when the initial page came out.

BH Okay so you got a page at nine (9) P.M. is that the deal?

MJ Yeah right around there.

BH Okay and then what, what was, what did the page say?

MJ Uh it said to uh to call Sergeant Nova at his, it gave his home phone number.

BH Okay good.

MJ Uh in regards to the call out and that's all it really said.

BH Okay so you called Nova?

MJ Called Nova, he uh gave me a little brief uh synopsis of what was going on and that was that uh there's been a agency assist request for our S.W.A.T Team to relieve the uh Humboldt County Sheriff's Office S.W.A.T. Team for a barricaded [REDACTED]

BH Okay, and then at that point uh did you guys um uh start deploying?

MJ Well, excuse me, well he said that we weren't gonna leave our department, our S.W.A.T. Team wasn't going to here till anywhere between uh zero, zero thirty (012:30) hours and zero one hundred (0100) which would be on the fourth (4th).

BH Okay.

MJ That morning, uh therefore I had plenty of other things to do, I had to work out the deployment issues,

BH Okay.

MJ For uh upcoming watches and for my watch and

BH Right.

MJ Call people and gather (inaudible) that, that sort of thing.

BH Okay so um what time did you, you guys loaded up here, did you have a briefing here before you left?

MJ Uh yes we did.

BH Okay so you had a little uh, uh brief on the incident?

MJ Yes.

BH What was uh, what was your synopsis of what you were going to?

MJ Uh well the final information we got before we left was that uh we got the [REDACTED] name and I don't remember his name other than his first name [REDACTED]

BH Okay, right now that's fine.

MJ But uh we got the [REDACTED] uh name, we got a little back ground information on him, that being that uh one (1) of our other sergeants Armstrong had dealt with him earlier in the week for a felony vandalism uh we were told that the uh [REDACTED] had some [REDACTED] in the past

BH Mm hmm.

MJ And uh was known to be confrontational and not very law enforcement friendly,

BH Okay.

MJ Uh we got uh, uh photo of him, of the booking photo

BH Good

MJ Again from most recent arrest, we then got the information that he had uh fired uh at the deputies on scene and actually when uh, to back up a little bit why I was after I initially talked to Nova and started my, done my briefing and started technically my patrol watch, while I was going home for equipment run for myself, I heard on the scanner that this [REDACTED] had fired again on the deputies,

BH Okay.

MJ So that was the information that I had, that was the second (2nd) time that he had fired on the deputies that were on scene, the perimeter units.

BH Okay.

MJ So all that information we got and was dispelled in this uh briefing,

BH Good.

MJ Prior to going out there.

BH That's fine, so you guys got deployed, what time did you guys approximately make it out to the scene?

MJ I think somewhere around two (2),

BH Okay.

MJ Two thirty (2:30) maybe at the latest, what we got, but I think around two (2) is the best estimate.

BH So two (2:00) A.M. you arrived; you guys unpacked your stuff.

MJ Right we're geared up most of us geared up before we even left.

BH Okay.

MJ So we arrive uh we meet with uh I think it was Quenell from uh

BH Detective Quenell or uh?

MJ No Deputy uh, Sergeant I think it is Quenell from there S.W.A.T. Team.

BH Okay.

MJ Prior to us meeting with him however Nova went and had a briefing with uh Cavinta,

BH Okay.

MJ Lieutenant Cavinta on scene there, came back then we were again briefed of what our uh details for the uh deployment were that being we were split up into different groups and being deployed to different areas around the perimeter,

BH Okay.

MJ We were again advised uh what contact they had with the [REDACTED] that he had been fired upon, he told us where vehicles were on scene, the lay out of the building, you know how, how they numbered the sides of the building,

BH Okay.

MJ The front, those sorts of things.

BH Mm hmm.

MJ From there then we were led by groups or by pairs to our assigned areas.

BH Okay good so what was your um, what was your mission at that point?

MJ The, the S.O.

BH You were there to relieve them?

MJ Correct.

BH And what did they say your mission was?

MJ Our mission was to hold the perimeter.

BH Okay.

MJ Nothing more, just to hold the perimeter.

BH Okay. Good deal. So if you can you got deployed out to the scene, if you can, can you mark on a map where you were deployed to initially?

MJ I was deployed to this vehicle right here.

BH Okay so the front of the Hoopa Valley Tribal Police Expedition?

MJ Correct

BH Okay.

MJ And I was uh primarily we traded off as cause there was four (4) of us in that area.

BH good.

MJ We traded off in pairs of watching the building and uh we had night vision uh, one (1), one (1) of us had night vision uh one (1), one (1) uh of us was on night vision, the other would be on the rifle watching the number four (4) side of the structure.

BH Okay so sometime after two (2) A.M. you went to that point and then you traded with four (4) people watching,

MJ I traded with two (2) others.

BH Two (2) other people,

MJ Me and three (3) other people went,

BH Okay.

MJ Were working in pairs.

BH Okay. And your idea was to watch the number four (4) side and number three (3) kind of side?

MJ Uh three (3) peripherally, there, there was somebody else assigned to three (3) but we could see a window right here at this corner, kind of the four (4) side corner, three (3) four (4) side corner.

BH Okay.

MJ As well. I couldn't see the rest of this due to the terrain and shrubbery,

BH Right.

MJ And stuff but our primary objective was to watch the number four (4) side.

BH Great. Okay so uh anything significant happen at that point um, uh you know up to uh during the nighttime hours?

MJ Uh nothing really significant uh at one (1) point we uh because of the uh lighting issues and we could see uh an interior light pretty steadily on at the four (4) "B" window there which we were assuming would probably be living room area.

BH Uh huh.

MJ And uh we could see a light often flickering kind of in the four (4) "A" window there.

BH Okay.

MJ And so at one (1) point uh my team leader uh Todd Wilcox and I advanced a little bit on the structure to get a better view and to hold a better perimeter and we did that by going up some terrain here,

BH Mm hmm.

MJ If you let me see your pen I'll mark it, there's a large pine tree here, there's another large pine tree here,

BH Okay.

MJ And this is of course hill, I see you've got some uh,

BH Uh huh.

MJ Some markings for that. We advanced up to this first (1st) pine tree, I'll mark it number one (1) here,

BH Okay.

MJ And took a view there for probably no more than a half hour, just to get a better view of how the front laid out, if you remember when we first got put on this point it's pitch black,

BH Yeah.

MJ Actually our whole uh distance and perception is kind of skewed because you're looking through the night vision the whole time,

BH Right.

MJ You know who that distance gets kinda off, so we, we came up to this pine tree watched it for about a half hour then ended up backing out and retreating back to the vehicles.

BH Okay, good deal.

MJ Other than that, the whole time that we were there there's nothing

BH Nothing significant?

MJ Nothing significant, we saw some movement inside at one (1) point um from what we assumed was the [REDACTED] and uh best we could determine there was only one (1) person from the movement we saw but never,

BH Now

MJ There was no contact ever made with him,

BH Okay.

MJ There was no attempt at contact made with him, he never uh brandished a weapon or yelled made any, any significant contact with us.

BH Okay. Nothing heard, okay so getting in to the day time hours, um how long were you deployed if nothing, if everything stayed the same you're still watching that kind of four (4) three (3) four (4) corner that side, uh that stayed the same until you were relieved by the Sheriff's Office?

MJ That's correct they, after uh I god I'm guessing eight thirty (8:30) nine (9:00) o'clock, sometime around there they come back and relieve us.

BH Okay.

MJ And uh it's three (3) or four (4) guys from their SWAT Team,

BH Mm hmm.

MJ Who moved back up to the vehicles where we are and take over basically our position and our duties.

BH Okay.

MJ We go back to the command post there at the, the head of the road,

BH Mm hmm.

MJ And strip our gear and take a break.

BH Good. So I, I guess somewhere down the line you were redeployed?

MJ That's correct um about gees I would say about ten thirty (10:30)

BH Okay.

MJ We were told to gear back up and that we were gonna assist the S.O. again, that they were going to uh start attempting communications, they were going to try to deploy a throw phone, and or get on a P.A. and try to get the [REDACTED] to start communicate with them.

BH Okay.

MJ And they wanted our assistance in uh helping with perimeter or whatever duties were gonna be determined by the S.O. from there.

BH Okay and then so where were you deployed for that operation?

MJ For that operation uh lets see what was the first thing that we were to do, we were deployed as a team to the I think initially the number two (2) side, that's what it was uh after we talked and Nova briefed with Lieutenant Cavinta again, it was decided that uh the communications had failed, this is over a little bit of time of standing out here, initial communications attempts had failed with this [REDACTED] and they wanted to set up to deploy gas so they send out S.W.A.T. Team

BH Mm hmm.

MJ To the number two (2) side as a unit and a team to deploy gas into the number two (2) window.

BH Okay.

MJ Number two (2) side window I should say.

BH So was that the entire team went over there then?

MJ The entire team went.

BH To assist in deploying gas, okay?

MJ Correct.

BH And who deployed gas from that side for you?

MJ That would be Officer Tim Jones and Officer Louis Altic

BH Okay. Um and so your primary position was to provide cover uh provide basically for those gas people.

MJ That's right, exactly.

BH Okay. Um we're going to talk with Jones and Altic about the deployment of the gas, so,

MJ Okay.

BH Okay um unless you see anything significant about them they just deployed gas on that side.

MJ There's only one (1) thing significant about that whole event.

BH Okay.

MJ And that was our distance,

BH Okay.

MJ We were, the closest we were able to get because of again terrain and open, open area,

BH Mm hmm.

MJ Was, I think it was eighty one (81) yards,

BH (Inaudible).

MJ Eighty one (81) to eighty four (84) yards is what, cause uh our sniper Ron Harpham had a range finder

BH Okay.

MJ And he ranged it and why I saw that was significant, that's a pretty far distance to punch gas and be accurate with a gas gun,

BH For sure.

MJ and gas rounds and it, it proved to be difficult for them, they had to fire a lot of rounds to get actually penetrate through that window, actually hit that window I should say, once they hit the window, the rounds would go through it but getting into that window was,

BH (Inaudible).

MJ (Inaudible) for them.

BH I can believe that. Okay uh so the distance though if you can it was, it was, were you deployed straight on that number two (2) side or?

MJ Uh not quite straight on it's up; it would be right up here.

BH Okay.

MJ Right about here and then that was the other issue was such distance, the one's (1's) that were hitting the wall even though it's a thin trailer wall, since there was a slight angle, they would hit and just kind of dent and deflect,

BH Okay.

MJ Rather than punch the wall at all.

BH Okay so uh the rounds that made it in, you did see that the gas deployed uh,

MJ Yes.

BH You did see smoke coming out or the,

MJ You could see smoke coming up, going up but it wasn't coming out that window, the wind from the time they started deploying gas, the wind primarily uh give and take some minor

wind shifts primarily was blowing from the number two (2) side, towards the number four (4) side.

BH Okay.

MJ And pretty strong so that even when up to the point when the structure was ablaze and uh fully engulfed, the smoke even when it engulfed this final room that this number two (2) side uh borders here, the smoke was still very lightly pouring out that window,

BH Right.

MJ Cause the wind was just blowing it so hard threw that structure.

BH Right.

MJ But you could see, when the rounds went in you could see the smoke filling the room.

BH Okay. Good. Uh was there any, did you see any body in that room, did you see any person in that room?

MJ I never did personally see the person in that room, however the over the radio this road that uh continues past,

BH Yes.

MJ It comes out here, where there's very clear view of the number two (2) window as well and there was uh and S.O Sniper and I think a couple other S.O. S.W.A.T guys holding this side as well and I don't remember his name but he came over the radio a couple times and said he actually saw the [REDACTED] in there.

BH Okay.

MJ He actually saw him take a blanket or something off that he was

BH Oh okay.

MJ Covering himself with and that, that information came across radio to us,

BH Mm hmm.

MJ But we never could see him at least personally,

BH Right

MJ I did never saw him directly threw that window and it was kind of articulated that he was at this two (2) three (3) corner with, would be

BH Okay.

MJ In a blind area for me to see him.

BH For sure yeah okay, so then deploying gas um and then that was about eleven (11) o'clock I would imagine, sometime times are kind of getting (inaudible).

MJ Some time, some time around there.

BH Okay so

MJ Sometime between eleven (11) and twelve (12) would be,

BH So there were several volley's of gas,

MK Yes.

BH Okay, we'll get that specifically but you saw several volley's of gas um at one (1) point there was a fire that occurred,

MJ Correct.

BH Okay um did you see um, did you see when or where um actually a fire was started or did you see any significance as far as smoke changes or something that's different than the C.S. or C.N. gas as opposed to a fire smoke?

MJ Oh yeah well I, I definitely knew when a fire was at least beginning, in it's beginning stages. I saw the smoke initially pouring out the uh roof line of the number four (4) side.

BH Okay.

MJ And you could see it kind of blowing up from there, as I said the wind was blowing that way,

BH Mm hmm.

MJ But you clearly see the black smoke coming out of that, what I would assume would be the small attic.

BH Okay. So you guys deploy gas in the number two (2) side, you first saw this, this the, the uh fire smoke that um significantly different type smoke uh coming out of the number four (4) side,

MJ Well after the gas, well after both view and (inaudible)

BH Well after, both view and (inaudible)

MJ This was, actually, actually that fire smoke didn't occur until after there were deployments of uh hand canister by the S.O. the S.O. Team moved up and deployed uh I think two (2) different times they moved up on the building with shields and deployed hand canisters of gas.

BH Oh

MJ In through the "A" and "B" window of number four (4) side.

BH Okay.

MJ And it wasn't till after that, some time even after that, that I started seeing the black smoke.

BH Okay.

MJ And the volleys of gas both by them and by us, the fairground volleys were

BH Mm hmm.

MJ Were long before that fire started.

BH Okay. Good deal. Did you see any move, after you saw that there was actually a fire going, there was dispatch that looks like a fire going in number four (4) side, did you see any movement on the inside?

MJ I did not but I could hear it.

BH You could hear, what were you hearing?

MJ You could hear uh, and actually I saw a change in the color of smoke,

BH Okay.

MJ Which lead me to believe or at least I thought that he was either trying to stoke,

BH Okay.

MK Or put it out,

BH Okay,

MJ Cause there was a definite change from the black smoke to more white cloud smoke coming, which often you see when fireman hit, hit the fire with uh the water hose,

BH Right.

MJ I don't know shit about fire science and

BH Uh huh, right.

MJ And, and fire fighting but

BH But just based on your experience of,

MJ Right.

BH Camp fires and building fires at home.

MJ Right, it was clearly a change in the smoke.

BH Okay.

MJ So uh back to what I saw or heard I, I didn't, I never saw him in the, in the building

BH Okay.

MJ The whole time, I, I was on the scene I never, ever saw the [REDACTED] inside.

BH Okay.

MJ But I clearly hear that uh something was going on in there that he was trying to either you know barricade himself in a room from the fire or,

BH Mm hmm.

MJ He was uh over there tending to it somehow or another.

BH Okay so you hearing this stuff on the inside, do you think that you could have heard someone screaming for help?

MJ Easily.

BH Easily okay.

MJ Easily.

BH Okay and did you ever hear any voice in there someone screaming for help, I give up, anything on that side?

MJ Never.

BH Never, okay but you heard walking, you heard things moving, uh did you ever hear anything one (1) talking,

MJ Well I tell you what I heard the dog barking in that house.

BH There you go okay.

MJ When uh, when they went up to deploy those hand canisters in there or when they started the first volley of gas.

BH Okay.

MJ It's one (1) of the two (2). At one (1) point you could clearly hear the dog barking in there.

BH Okay. Okay and uh did you notice if the power was still on at that point, did you see any of the lights or nothing?

MJ Uh uh. I couldn't tell.

BH I mean it's not light time so or daytime.

MJ Yeah I, I, I wouldn't know either way.

BH Okay so again it's, it's your, if someone was giving up you could have heard them, yes?

MJ Uh, uh again easily I think.

BH Yeah, yeah.

MJ Especially since now you have multiple broken windows in the place,

BH Oh good right so the windows were broken on the number two (2) side from the gas and then also the, the four (4) side?

MJ Uh initially when we got on scene the window "A", one (1) of the panes on that was broken from uh the exchange of gunfire.

BH Mm hmm.

MJ Least what, that's my interruption or the information I had, and then window "B" then was broken again from additional gas.

BH One (1) other question okay you're eight one (81) yards away from the trailer on the north side, number two (2) side,

MJ Mm hmm.

BH Negotiations were occurring on the south side, the number four (4) side,

MJ That's correct.

BH Out of a P.A. could you clearly hear the P.A. and the announcements that were given?

MJ Yes I could.

BH Okay. Could you describe the kind of things that you were hearing?

MJ Sure he uh, it was uh Sergeant Mike Fridley who was,

BH Mm hmm.

MJ I could clearly determine his voice on the P.A. he was saying generally, this is not verbatim,

BH Mm hmm.

MJ But generally he would say you know he's announce who he was, this is Mike, I'm with the Sheriff's Department, then he'd call the [REDACTED] the by his name, [REDACTED] you need to come out, you need to come out of the trailer, this is not a big deal

BH Mm hmm.

MJ You know come out the front door and talk to us, you need to come out you know we'd like to help you, those sort of things, it's not a big deal, nobody's gonna hurt you, leave your weapons in your house, just come out with, where we can see your hands and we'll talk about it.

BH Okay.

MJ And then later once the fire starts and that we notice that it's probably a fire,

BH Mm hmm.

MJ You know most likely, I haven't seen actual flames yet but you see the fire smoke, he's on the P.A. again you know constantly and, and steadily telling this guy, [REDACTED] you know we think your house is on fire, we don't want you to get hurt, we want to help you need to get out of the house so we could help you, get out of the house, your house is on fire, just repeating that.

BH Okay. So uh, uh you feel the number two (2) bedroom or whatever this room is back here um this was pretty much the last spot that the fire got to, the smoke, the heavy black smoke.

MJ Without a doubt,

BH Okay.

MJ Without a doubt, cause when I was watching it through the vents on the roof as well.

BH So you could see a steady progression as the fire is heading north, towards the number two (2) side, okay.?

MJ Yes.

BH In your own, you know expert opinion uh you watching that window um you feel that if someone was inside the house and wanted to give up, they could have come to that window and they could have yelled and you could have responded to that?

MJ Yes.

BH Okay and you could have preformed a rescue?

MJ Without a doubt

BH (Inaudible) okay and where you guys set up for that in case?

MJ Sure we were.

BH Okay good.

MJ And, and we were absolutely prepared to do that.

BH Good and um okay so uh demob stuff now okay, finally this thing is fully involved, you get the order to stand down, what's the, what's the,

MJ You know we didn't even get a real order to stand down, it was, it's just pretty obvious you know

BH (Inaudible).

MJ We didn't, I didn't leave my position

BH Mm hmm.

MJ Uh through out this time, and you'll hear from interviews that the, the team was kind of bifurcated and me and um Officer Gary Cooper were the only two (2) left at the number two (2) position at least on the hill here. The S.O. guys still had it and the Sniper still had it but part of our team went to the number three (3) side to deploy more gas. Like I say I'm sure they'll tell you about that in their statements, but uh after this things fully involved you know and it's, it's, all obviously we watched it move down the number two (2) side, we didn't leave until we actually saw the flames here ripping through the, this, this room that the number two (2) side borders, and finally even at that point when it's full of smoke, it's still barely pouring out of the window but it's so black in there you can't see.

BH Can't see.

MJ And obviously there's I mean it was just,

BH No chance of life?

MJ There's no chance at life at, at that point.

BH Okay.

MJ Plus the S.O. guys were going to hold that, that too so finally at that point we decided to walk up and they, they had moved these vehicles and you could hear over the radio that fire, there gonna let the fire truck in, made the decision that it was safe enough to move the fire truck in, that (inaudible) pretty much after that for me, so I started back up the hill and to leave.

BH And to leave, okay good, and um yeah so at that point no one could have survived, you finally gave, you finally gave up that position when no one (1) could survive inside that environment?

MJ That's correct.

BH Due to if not flames, the smoke?

MJ The smoke, yeah.

BH Yeah, cause (inaudible).

MJ Cause there's just no way.

BH There's no way.

MJ Absolutely no way.

BH Okay.

MJ The structure finally went up in a full blaze.

BH So you then uh at that point, stood down, went back to the vehicle and then that's when you were checked out by um, uh your team leader and then the investigators then you went home?

MJ Correct.

BH Okay during this whole incident did you fire a round?

MJ No I did not.

BH Okay um I think that is it, if you think of anything else significant that you want to talk about right now?

MJ No.

BH That's pertinent to the case?

UM (Inaudible).

BH Okay so we're concluding the interview, it's eleven forty two (11:42).

End of transcript.

Transcribed on 7/11/2007 by [REDACTED] 0608

HUMBOLDT COUNTY SHERIFF'S DEPARTMENT

CASE: 200703162

INTERVIEWER: Sgt. Bart Silvers & D.A. Investigator Bill Honsal
[REDACTED] Attempted 187/ Officer Involved Shooting.

STATEMENT OF: Officer Greg Hill

DATE & TIME: June 5th, 2007 @ 12:50 p.m.

LOCATION: Eureka Police Department, Eureka, California

ALSO PRESENT:

BH Bill Honsal
BS Bart Silvers
GH Greg Hill
[REDACTED] [REDACTED]

BH So it's the fifth (5th) of June at uh twelve fifty (12:50) and uh we're here at E.P.D. talking with uh Officer Greg Hill, interview room, uh Greg, spell your last name?

GH H-I-L-L.

BH Okay. So we're talking about the incident that occurred over the weekend up at Hoopa, uh this incident started on uh June third (3rd) and uh tell us how you got notified about this incident?

GH Uh well about uh twenty thirty (2030) hours on the third (3rd), I was at home, I was called by Sergeant Nova uh from his home, uh requesting if I was available to respond to assist the S.W.A.T. Team with a barricaded [REDACTED] in Hoopa.

BH Okay. Uh were there any instructions at that time?

GH Uh at the time was uh to be ready to leave headquarters at twelve thirty (12:30) um to ensure that I brought my uh side arm, uh my patrol rifle and as much gear, you know all my necessary gear for patrol rifle.

BH Okay. So you were on the patrol rifle team?

GH Yes I am.

BH Okay and what does that, what does being on the Patrol Rifle team, what does that, what does that mean?

GH Uh

BH What is the significance of that?

GH Uh the significance of that is we carry an M-16 (sixteen) uh, (inaudible) on duty uh we carry it on duty, we also provide support and assist the S.W.A.T. team as needed for security and perimeters.

BH Okay. So um you're there to assist the S.W.A.T. team, being on Patrol Rifle, you got the call at twelve thirty (12:30) hours, or at twenty thirty (2030) hours, and then you had to be ready to go at midnight thirty (12:30 am.), so uh I assume you responded to the station?

GH I did.

BH You got changed out?

GH Yes.

BH Okay and then um, uh did you guys leave at twelve thirty (12:30)?

GH Uh twelve thirty (12:30), twelve forty five (12:45 am.).

BH Okay, and so at that point did you have a briefing at uh at the, at the station?

GH Yes.

BH Okay. Can you tell us what that briefing you know, summarized what, what it consisted of?

GH Uh it consisted of just to, what had uh, what information Sergeant Nova had at the time was that uh Yurok Tribal and Sheriff's Officer's had responded out to a welfare check in Hoopa, uh they arrived on scene, [REDACTED] saw [REDACTED] out front with a firearm, uh so, he leveled the firearm at the officers, the officers retreated back to a covered position uh somewhere between uh, somewhere after that time he fired upon the two (2) or fired upon two (2) tribal vehicles,

BH Mm hmm.

GH Uh and then sometime between I don't know, uh he, Sergeant Nova said sometime between eight (8) and nine (9) that they were, they'd been, obtained information that they were, that they'd obtained the information that uh, they'd also been fired upon again and that they deputies had returned fired.

BH Okay.

GH Supposedly that it was a [REDACTED] [REDACTED] who we had had recent contacts with here in Eureka um and that there were possibly several firearms inside the residence.

BH Okay, were you give a description of the [REDACTED]

GH Uh yes we were.

BH Okay. And were, was there only one (1) [REDACTED] that you were interested in?

GH Yes, at that time there was only one (1) [REDACTED] we, we weren't sure, we were told at the time that we weren't sure if there, there was a possibility that there may have been somebody else inside the residence.

BH Okay. Okay so then you responded from E.P.D. and you drove to the, the scene at Hoopa?

GH Yes.

BH Okay. When you got to the scene tell us, us what happened.

GH Uh we arrived at the scene uh started to gear up, we were given more information from Sergeant Nova that uh of the scene, a description of the scene uh where the location of the perimeter of, of where deputies were located at around the perimeter um so we could relieve them and pretty much keep the perimeter uh surrounded just to insure that he, he didn't leave or anything like that, um and we uh, I was assigned to go with uh four (4) other members, uh three (3) other members to where the some of the S.O. teams were members at the patrol vehicles that had been fired on.

BH Gotcha, okay so you're, can you tell us what your primary mission was when you got deployed out to the scene itself.

GH My primary mission was to support the SWAT Team uh with the perimeter around the building.

BH Okay, and what was the E.P.D. roll at that point?

GH Support.

BH Support.

GH Yes.

BH And um, um was there any direction given to you guys, as opposed uh you know as, as far as your specific mission uh during the night, what were you guys suppose to do?

GH Our, from what I understand, what we were told to do was provide perimeter security for the residence.

BH Okay so you provide, overnight you were suppose to provide security for the residence so the deputies can be relieved?

GH Can be relieved to get some rest.

BH Good. Okay and uh so there's a map in front of you okay that's detailed as far as the uh [REDACTED] road, which is off of Bloody Camp road um and to where the incident occurred which is the trailer um this is the uh, the two (2) Hoopa Valley Tribal Police cars.

GH Okay, Expeditions?

BH Expeditions yes.

GH Okay.

BH They're deployed there and this is the Yurok Expedition up here uh if you can, can you please detail on this map where you were initially deployed to?

GH We were initially deployed time uh of the, both the driver side and passenger side doors were open on the lead vehicle.

BH Uh okay could you use your pen?

GH Sure

BH To make whatever notes?

GH Yeah. So the passenger side door was open.

BH Mm hmm.

GH And the drivers side door were open, uh we were initially deployed up to here where there were S.O. units.

BH Mm hmm.

GH We were going to relieve them, um for the first hour, hour and a half I was on this side, there was a ballistic shield.

BH Okay.

GH So it was on the passenger side covering where I could see the A and B window of the residence.

BH Okay.

GH On the four (4) side.

BH The four (4) side?

GH Yes.

BH Okay so this is, if this is pointing north, you're on the south side, which is labeled number four (4)?

GH Yes.

BH Okay. And so your job was to contain um in the field of fire, number four (4), you had your rifle aiming towards that point?

GH Yes.

BH Okay. Um did your position change through the night?

GH Yes it did through out the night um, through out the night I had rotated with I don't know who rotated to the other side, I think Nova rotated the other, Sergeant Nova rotated to that side, I rotated back around over to this side where I was an observer with the N.V.G.'s.

BH Okay, and uh can you tell me, can you tell me what that is, what's the N.V.G's.?

GH N.V.G.'s they're night vision goggles.

BH Thank you.

GH Um do you want me to explain, I, I'd seen some things (inaudible).

BH Okay, yes okay so you had night vision goggles on?

GH Yes.

BH Okay can you describe um the weather that night and the lighting, without the goggles?

GH Without the goggles, it was, I'd say uh, uh almost a half moon, you know between a half and a full moon, uh it, it was somewhat cloudy, the clouds were starting, it was partly cloudy so the clouds would roll in front of the moon and us visibility was uh twenty five (25) feet,

BH Okay.

GH Twenty five (25) feet um, you could make out the outline of the outside of the residence and uh the outline of both the windows that we could see on the fourth (4th) street side, um I say street, four (4) number four (4) side.

BH That's fine.

GH And uh but we, we couldn't see into the windows.

BH Okay, were there any uh street lights on?

GH No.

BH Were there any headlights on?

GH No.

BH No okay so nothing illuminated the, the, the residence?

GH No.

BH Where the [REDACTED] was held up, okay so you used night vision goggles, N.V.G.'s?

GH Yes.

BH to look on the number four (4) side. Was there anything significant that you saw on the number four (4) side using night vision goggles?

GH Um (inaudible) while using night vision goggles, I had them on for a little over an hour,

BH Do you remember what times that possibly was?

GH At about four o'clock, at about zero four hundred (0400) hours, I think I was handed the N.V.G's. and uh I think we moved back at about five twenty (0520), so about an hour and twenty (20) minutes.

BH Okay.

GH Right in there. Uh I was watching the residence, through out the, the time that I was watching, I could see uh through what I could see uh, uh, with what I could see with or with the night vision goggles, I could see him walking a couple times from right to left, left and right, back and forth across this window, this window was lit up from the inside with a, a looked like some kind of a light on inside uh with a TV, flickering.

BH Okay and that was number four (4) side?

GH That was number four (4) side, "B" window.

BH Okay uh now that image, were you seeing his, his figure in a shadow cast upon window coverings or were you actually seeing uh, uh a person through a clear glass window?

GH I was not seeing a person through a clear glass window, I was either, I was either seeing a shadow or at a fate distance back in the room from the angle I was in, I could maybe might have had a look of his, edge of his head or something as he was walking by but I could not make him out uh directly. I could see at one (1) point, some kind of arm movement uh that based on a shadow and based on what I could see, it looked like an arm movement

BH Mm hmm.

GH Um but he never came to the window uh I never got a clear view of him through the, what I could see through the night vision goggles um,

BH But definitely a figure?

GH Definitely a figure, definitely.

BH Could you make out the sex of the figure?

GH No I could not.

BH Okay, but a figure. Now um getting back to the flicker of the light in here, um uh the, was the light strong inside, was it faint?

GH Uh huh it was a, it was a faint white light uh or I'd say like an orange light kind of a uh, it looked like a lamp with a light up.

BH Okay.

GH Um and then the TV, and the TV was like a brighter light in that flicker (inaudible).

BH Okay so getting back to the light, is it more like an electrical light, could it have been an oil lamp, could it have been a candle?

GH It, not a candle, maybe, maybe an oil lamp, I'd say maybe an oil lamp but not a candle,

BH Okay.

GH It was just to light up to be a candle.

BH Too lit up?

GH Because it was clear sometime around five (5) o'clock he shut the lights off,

BH Okay.

GH And it was clearly like, it shut off it was dark.

BH At five (5).

GH Um and that was about almost right at five (5) o'clock in the morning.

BH And that included TV and light?

GH At the time, both, TV and light, um a minute or two (2) gosh, I can't really tell you the time but

BH That's okay.

GH A minute or two (2) later the TV came back on, you could see the flickering, or what we would figure is the TV, I mean none of us knew for sure but we were guessing it was the TV because of the flicker because I mean based on yes I work as a cop at night, I see TV's on and at peoples residence every night I see,

BH Right. Okay so, good. And um that was about five twenty (05:20) you then, you then got off the N.V.G.'s?

GH No five twenty, five twenty it became light enough for that, that where I was in my position was clearly a hazard to myself uh being visible.

BH Okay so then you kind of retreated back,

GH Retreated back,

BH To cover position?

GH We did.

BH Okay so after five twenty (0520) you're still in the position behind the Hoopa Valley Expedition?

GH Yes.

BH Okay uh was there anything significant that happened in that position um, anything happen behind there?

GH No.

BH You were just holding cover position

GH We were holding position, we were only holding cover on the fourth (4th) side um and the only, like I said the only thing that happened was that we did see some movement inside the "B" window and that the lights were shut off at five (5).

BH Okay so and that happened at, so after uh what time were you relieved form that position?

GH Uh from at five twenty (0520) we were at a comprising position where we were just to visible,

BH Mm hmm.

GH We moved back to, to an S.O. vehicle uh and a Hoopa Tribal Crown Victoria that were positioned uh just twenty (20) yards back

BH Mm hmm.

GH Positioned ourselves there um we had, Officer Wilcox and Officer Jones went back up to the this rear vehicle to see if they could get a, still use it as support uh and cover uh to observe those two (2) windows, we moved back up to that position right there where we could observe the uh windows until approximately seven thirty (7:30) eight (8:00) o'clock, that's my best guess I don't (inaudible),

BH Okay,

GH Looking at my watch.

BH What happened at seven thirty (7:30) eight (8) o'clock?

GH Uh the Sheriff's Department, the Sheriff's Department SWAT Team members came and relieved us uh and we were relieved and uh went back to the uh to where the uh Command van was.

BH Okay and then um so then you had a break?

GH We did

BH Okay.

GH We had about a two (2) hour break.

BH Okay and then so, what time did you uh get back into it.

GH Approximately a couple minutes after ten (10), Sergeant Nova came up to the team instructed us uh to gear up and that we would be assisting with perimeter and security for the Sheriff's Department when they would be deploying gas.

BH Okay so tell us where you were deployed and what your specific um, specific mission was on that deployment.

GH Uh initially we were told that we were going to be, to provide support.

BH Hold on a second, mark a number one (1) where you initially deployed, just the general area. Okay and then, and then mark a number two (2) where you were deployed the second (2nd) time.

GH The second (2nd) time we were initially deployed up to the Crown Victoria's were right here,

BH Okay.

GH Okay that's where we were deployed up to, initially

BH That you initially, that you pulled back after, after daylight.

GH Where we were pulled back.

BH Okay.

GH Initially we were set back up to uh there originally with the mission of providing support to the Sheriff's Department, we were told that once we got up there uh or I believe that the, that our two (2) uh gas guys were told um that we may be, may be assisting with the pulling gas.

BH Okay.

GH So uh we came up to here,

BH Okay.

GH We stood by um and we simply were out of view (excuse me), out of view and set back in there um and just waited.

BH Okay.

GH Uh we were told over the radio that air support, which was a medical air support was going to be delayed to forty five (45) minutes to an hour and that we were just going to continue with uh P.A. speaker requests,

BH Okay.

GH For him to come out, uh attempt to contact him uh communications.

BH Okay so in your number two (2) position here, after you had your break you were deployed there with your rifle, um and then um in your number one (1) position you have the S.O. deputies there,

GH Yes.

BH And were they using uh the Hoopa Valley Tribal Police car as a,

GH They were using both those vehicles as,

BH As a P.A. what were they using as a P.A. or a blow horn?

GH Yeah I think that they were using one (1) or two (2) of them, I don't know uh, but they could have been using a blow horn.

BH Okay.

GH But they could have been using a blow horn, I don't know..

BH But it was an amplified?

GH It was an amplified device; there was a siren that went off for each amplified device to try to gain his attention,

BH Okay, and uh was there any other noise, anything else um was there, was there any loud noises coming from the trailer like loud music, like a loud television?

GH We couldn't hear anything.

BH Um could you ever hear when you were deployed initially over the night or at that point, anything from the inside, could you hear anything, any actions occurring, anything?

GH Every once in a while you could hear a thump,

BH Okay.

GH Or you could hear movement, but that's it.

BH Okay, when you describe a thump or a movement can you say, can you kind of describe what that was coming from or your best guess as far as,

GH Best guess it sounded like he was moving something around uh and bumping things against the walls or uh it almost sounded like somebody punched a wall, like angry, angry, and man and punched the wall.

BH Okay could you, could you hear voices?

GH Uh oh at sometime, sometime before I went to the N.V.G.'s, uh I'm sorry I forgot to mention this, sometime (inaudible) N.V.G.'s, when I was on the passenger side of the vehicle covering I heard from the residence some kind of a muffled voice and I couldn't make out what he said.

BH Now this couldn't be confused with uh, uh another officer being deployed somewhere else?

GH It, the possibility yes, but it sounded like it came from inside the residence, it sounded like it came from directly inside the residence and it was very short, maybe it was a sentence worth of words and

BS And what's the distance that you are there?

GH Well initially we thought we were a lot uh a lot farther away because we were looking through it with N.V.G.'s and at night uh but the distance between here and here is like sixty five (65) yards, sixty (60), sixty five (65) yards between the two (2).

BH So uh do you think, was that muffled, was that a shout, was that?

GH Initially it sounded like a shout and then a muffled something, him saying something else, or somebody saying something else and then that was it.

BH Okay.

GH It was maybe five (5) or six (6) words and the shout was like I say I couldn't understand what, what it was. I looked over at, I think it was Officer Wilcox and he said did you hear that and he said yes I heard it and I'm like what was it and he, he couldn't understand what was said either, we just heard something.

BH Okay.

GH And that was it.

BH That was it.

GH No more sounds after that.

BH Gotcha. The sound, but you think the P.A. was making a much louder sound than, than that?

GH Oh yeah.

BH Yes okay. So it could have gone through the walls and someone inside could have easily heard it.

GH Mm hmm.

BH Okay. So siren then a P.A. announcement and um so from your number two (2) position okay you're holding cover on the number four (4) side. Uh was your rifle aimed at this, at number four (4), could you see it when you redeployed?

GH When we redeployed?

BH Yeah re deployed?

GH When we redeployed no, we were out of the vehicle,

BH Gotcha.

GH The rise of the hill kept the vehicles uh, the rise of this hill kept us out of view so

BH Mm hmm.

GH Uh we were, we were simply standing by, this is where we first arrived and we were told the wait time for the helicopter,

BH Mm hmm.

GH So we initially waited there we stood by um and then uh the sheriff's, sheriff's, we got the okay over the radio from uh I believe it was Lieutenant Cavinta to go ahead start deploying, or the S.O. to start deploying gas?

BH Could you see them deploy gas?

GH I couldn't actually visually see them but I could see the vehicles, I could see a gas,

BH The vehicles.

GH I actually couldn't see the gas canisters from the position I was in.

BS The (inaudible) being dented and the ground going off?

GH I could yes.

BH Okay. So then um from your position, did that position change at all until the, the, the, you were um, the incident was over?

GH Yes it did.

BH Okay so where did you go to next?

GH After the first set of

BH And what time?

GH We were requested to see if we could move to a position to move to the number two (2) side, to the number two (2) window.

BH Okay.

GH Because the gas was only going into the number four (4) side at this point.

BS Uh so when you say "we" who was with you in the number two (2)?

GH At the number two (2) it was everybody or all the team members, except Officer Sanchez

BS Okay.

GH Who had moved up to provide support for uh two (2) S.O. deputies.

BH Gotcha, okay.

GH Whose batteries had died on the radio.

BH Okay.

GH So uh leading us was Officer Wilcox, he's a Team Leader, there was me, uh Lieutenant Johnson, Officer Cooper, or not Lieutenant Johnson, Sergeant Johnson, Officer Cooper uh Officer Jones, Officer Altick and me.

BS Okay.

GH Uh we moved back to Command van,

BS Mm hmm.

GH Made our way up a road, or somewhat of a road I guess it's just two (2) tire tracks that lead into the grass,

BS Okay.

GH Across the top out of view of the residence, down over to here, down hill position right here, we're on the number four (4), or number two (2) side.

BS Okay.

UK Uh Officer Hughes draw number three (3) in the area, I know that this is going to be eschewed a little bit but just in the area

GH Okay.

BH And I'll just kind of draw a little arrow pointed that way.

GH Uh we were, I'd say I think that we range finded it, we using a range finder we ranged it out to, to the building it was somewhere around eighty (80) yards, maybe a little bit more, eighty one (81) yards um that's the closes we could get, there was no more concealment uh or no more cover, the only concealment that we could see was grass um which couldn't provide us enough cover if he were to open fire on us, we didn't have anything, we didn't have anywhere to go.

BS So you had to go, you had, you had be far enough so where you can be safely lying in cover but close enough um to,

GH To see and to avoid gas.

BH (Inaudible). And that was the closest position you could find and that was approximately eighty (80) yards away?

GH Yes.

BH To the north of number two (2)?

GH Yes.

BH Okay, so at that point what was your, your specific mission?

GH Our mission at that point was,

BH No what was your mission?

GH My mission was to provide support for the, for the other officers and for the gas, uh the officers.

BH Okay

GH That were firing the gas.

BH Okay so you provided support for people that are going to dump some gas in there, deployed gas, okay?

GH Yes.

BH Um when your on the number two (2) side and approximately what time that, if you could guesstimate as far as if you were initially (inaudible) at ten (10),

GH Noon, noon.

BH Noon, okay.

GH Eleven forty five (11:45), noon.

BH Okay so eleven forty five (11:45) or noon time you gone to the number two (2) side, at that point did you see anything significant?

GH I could see some, it looked like he somewhat barricaded the inside of the number two (2) window, um

BH So you were looking at a clear window, you were looking at a window that was, had some coverings on it,

GH It was lines,

BS It was a what?

GH I, you know I'm not, I don't know if it was blinds, I don't have, have any kind of optics on my,

BH Mm hmm.

GH On my person but it wasn't blinds, it was a window that was approximately five (5) by five (5) foot with uh, it had, it looked like to me some kind of um, uh piece of thin plywood or like thin wood over it.

BH On the outside or inside?

GH On the inside of the window,

BH Okay.

GH I couldn't tell threw the glass it looked like some kind of a obstruction inside.

BS Almost like paneling, that kind of thing?

GH Paneling that's what, paneling that's what it was paneling.

BS Okay.

GH Like a picture, like, like you take something, take something off the wall.

BH Mm hmm. Like it kind of rested against there.

GH Mm hmm.

BH Okay. So then um I guess sometime after you initially got there you started, uh the team started deploying gas?

GH Yes.

BH (Inaudible) and you were providing cover for the team so,

GH Yes.

BH Uh without getting into specific's, specific's cause we're going to be interviewing the gas people, you saw who deploy what in there?

GH I saw Officer Altick and Officer Jones deploy gas from the thirty seven (37) millimeter gas gun.

BH Okay.

GH Deployment gun,

BH Okay.

GH Other than that I, I can't tell you any specific's, I don't know (inaudible) about gas.

BH Exactly and so they were trying to get gas threw that window, is that your best estimate?

GH Yes, we were trying to deploy gas through that window.

BH Okay so um did you see the gas, the gas canisters enter the window?

GH I saw, I, I can't remember the exact number but there was about five (5) or six (6) gas canisters, maybe a little bit more actually enter the window.

BS Except what was the,

GH There was total of seven (7) I think.

BS What was the gas, what was the appearance of the gas once it entered the room and it filled the room, could you see that the gas was being decimated in there?

GH I couldn't see no.

BS Okay.

GH Uh at that point we had out gas masks on, my gas mask was having some trouble and it was fogging up um, I knew we were making hits uh through the windows, uh I knew we were missing some of them because of the range.

BS Right.

GH But I couldn't specifically see any gas coming out of the, uh out of the inside.

BS Okay and so than after a couple volley's they, could you hear anything could you see anything, was there any person that came to the window?

GH No I didn't hear anything,

BS Okay.

GH Didn't see anything and uh nobody came to the window.

BS Uh when you're on this side, eighty one (81) yards, eighty (80) yards away from number two (2) that corner there, could you hear the S.O on there P.A. on the far south side, could you hear them ordering the [REDACTED] anything, any orders that you heard?

GH I don't recall. I can't remember if they did that when we were in that position.

BH Okay do you remember hearing anything as far as voices, concerning, coming from the trailer or any of the other deputies?

GH No.

BH Do you remember seeing any movement inside?

GH No.

BS So at some point um the S.O. distributed gas on the number two (2) or number four (4) side, E.D.P. distributed on the number two (2) side

GH Yes.

BH And um and there was a time when we, they were just waiting for the effects?

GH We, there were initially there, yes um we were requested over the radio a short time we'd been on Bald Hill, fifteen (15) minutes at this location for fifteen (15) minutes, we were requested to uh see if we can get into a position where we can get to the number three (3) side uh where there were uh two (2) windows and a door, uh to see if we could deploy into the, either one (1) of those two (2) windows or that door.

BH Okay.

GH Um at this point it was myself, Officer Wilcox, Officer Jones and Officer Altick pulled back from this position,

BH Okay do you remember approximate time that was?

GH We'd been at, we'd been there for fifteen (15) twenty (20) minutes so it was approximately just before twelve thirty (12:30) I would guess, I mean this is just guessing,

BH Okay yeah.

GH Approximately twelve thirty (12:30) we moved back up the hill out of the view of the residence

BH Mm hmm.

GH Uh and made our way over here where we crawled down to a at about this location, there was a tree, an oak tree,

BH Mm hmm.

GH And there was another oak tree right up here, not a very big oak tree there just like,

BH Mm hmm.

GH Thirty (30) feet tall, twenty (20) feet, twenty five (25) feet tall, uh myself we, and myself, Officer Jones and Officer Altick crawled down to there where we used the uh base of the oak tree as cover and concealment, uh Officer Wilcox stayed at this position right up here just above us, twenty (20) feet above us,

BH Mm hmm.

GH Um at this point here uh we were advised to, that once we were in position to advise command, command was advised and we fired a volley of uh gas threw these two (2) windows right here.

BH Okay uh what I want you to do is I want you to put a number four (4) where you uh, you were backing up Altick, okay and then just go ahead a draw in the windows where you remember seeing them on the number three side, approximates, and then and there was a door.

GH And then, do you want me to actually draw a?

BH Yeah go ahead sure, however you want to draw a door.

GH Guess, guess the doors right there.

BH Okay so how, what's the approximate distance from there to the number three (3) side?

GH From here?

BH Approximately?

GH Fifty (50) yards.

BH Okay.

GH Sixty (60) yards, maybe sixty (60) yards.

BH Could you see if there was anything over the windows, were the windows open at this point?

GH Uh this window had nothing uh that I could see threw it, uh at this angle that I was in,

BH Was it,

GH All I could see was kind of the edge of this window.

BH So it was still clear, you could see inside, but even though it's still (inaudible) corner, it wasn't covered up on the inside by any blinds,

GH It was dark insides, there was no blinds covering it so I couldn't actually see all that was inside what clearly what was inside, but I didn't see any blinds or anything covering it up.

BH Okay so there was nothing covering the window but you couldn't necessarily see inside,

GH No.

BH Because of how dark it was and how light it was outside.

GH And with my angle.

BH Yeah with your angle, okay uh the other window, it's in the middle?

GH Covered with wood.

BH It was covered with wood, okay. So at that point you deployed gas, uh did you see anything from the inside?

GH Did I see anything?

BH Did you see anyone come from the inside, did you see any figures, anything at that point?

GH Nope.

BH So it's about twelve thirty (12:30) twelve forty five (12:45) now you guys are deployed over there you don't see anything, you did a volley of gas, did you hear any announcements from the S.O.?

GH Yes

BH Okay.

GH I could hear, I could hear the, uh we did a volley

BH Mm hmm.

GH Um and the S.O. started their communications up again. I don't remember, I, I believe they did do communications from over here but I don't remember that,

BH That's okay.

GH Or they might have been doing communications while we were moving, I just can't remember uh, I can't remember specifically, there was a lot of times we, we tried several, several times to gain communications.

BH No problem, so were any of these windows broken out then by the time you guys deployed gas?

GH There was two (2) canister deployed into that one (1), and two (2) what do you want to label this "A"? We called this "A" and "B"?

BH Yes that's "A" and "B".

GH So "A" and "B" and we just called that the door.

BH Okay.

GH Um two (2) canisters deployed into there, one (1) canister missed to the left, knocked a hole in the wall um we don't know if that actually entered or not or if it was lodged in the wall,

BH Okay.

GH Um and one (1) or two (2) made it into "B". I don't remember how many fired total.

BH No figures were seen inside, no movement?

GH Nothing.

BH Okay you heard the P.A. but you couldn't hear anything, do you think that if you, if someone was on the inside uh do you think you could have heard them yelling or screaming from that distance?

GH Yes.

BH Based on what you were hearing that day?

GH Yes.

BH Okay.

GH From the distance I was I could have heard them.

BH Did your position change at that point?

GH No.

BH Or before?

GH No we stayed here.

BH For the duration of the operation you stayed right there?

GH I stayed right there.

BH At some point um if you remember what was the last time that anyone or whom deployed any gas?

GH Uh the last time I remember deploying gas was when uh twice this happened, the uh S.O. uh SWAT Team members approached

BH Mm hmm.

GH With a ballistic blanket to, I couldn't tell if they went to the "A" window or not, but they went to at least the "B" window, I believe they did go to the "A" but I can't remember, I can't, couldn't see them from the angle, but I went to at least the "B" window and deployed hand held gas canisters.

BH Uh huh okay so hand held there are kind of like the um, uh steel cylinder (inaudible)?

GH I would guess yes but I didn't actually see them in their hands.

BH Okay. But you just saw them deploying the (inaudible).

UM (Inaudible).

BH Did you see them pull pins, throwing things?

GH I saw them throw, they were close to the wall

BH Okay.

GH At the angle, cause you see at the, at the angle I was at I couldn't, I could only see you know just a uh a couple of feet out um so I could at one (1) point see a deputy step back, throw a canister in twice, I think one (1) time one (1) canister bounced off the wall and landed back down on the outside of the ground,

BH Mm hmm.

GH And the deputy ran back up grabbed it, threw it again, back into the window.

BH Okay, so did you see at that point where your position on number three (3) side, did you see the um the gas being decimated inside the residence?

GH Yes.

BH Okay what color was that gas?

GH It was white.

BH It was white, and then do you have experience with, with seeing um this kind of gas being deployed?

GH Yes.

BH Okay and um so uh did you smell any agent, did you smell the?

GH Yes the wind shifted and blew right in our faces,

BH Okay.

GH So we had to put our masks back on.

BH Okay so you definitely could, could smell that the, that the, that the room was filling up with, with gas, okay. Um after those gas canisters uh were deployed um could you give us a time reference at that point, there was, that was the last um chemical agents that were put into the residence, to the best of your knowledge?

GH Just a little bit before two (2).

BH Okay that was a little bit before two (2)

GH That's what my guess, best guess was, I don't remember looking at my watch specifically but my best guess would say a little bit before two (2).

BH At that point um, did you see um the smoke through the, you see the smoke fill the, the, the house, did you see at one (1) point where it cleared out?

GH Yes.

BH Okay.

GH Uh when they deployed the gas it filled up, you could see the windows, I mean I could see, at this point I could see the window it was just solid white at that point,

BH Mm hmm.

GH Uh but the whole window was solid white all the gas had dissipated out through the front windows uh and through the holes that were uh caused when we had deployed our gas from our side,

BH Okay.

GH Uh had completely cleared out to the point to where there was nothing else coming out of the building.

BH Mm hmm.

GH That I could see.

BH Okay so then it became clear again as far as you could tell?

GH Yes.

BH Okay at one (1) point did you start seeing smoke again?

GH Yes.

BH Okay and what time was that?

GH That was just a few minutes uh I'd say

BH If you can estimate?

GH Ten (10) to fifteen (15) minutes, somewhere in that time frame, ten (10) to fifteen (15) minutes after the last canisters had gone in.

BH So ten (10) to fifteen (15) minutes after it cleared or after the canister was thrown, I'm just, I didn't know if I understood you correctly?

GH Yeah and I think it was, cause it takes a few minutes for it to fill up, or

BH Right, right, okay.

GH So I'd say ten (10) to fifteen (15) minutes after it was initially thrown.

BH Okay.

GH And then after initially can, initially the canisters had gone in

BH Mm hmm.

GH By hand and then it filled with smoke, dissipated out, it took about five (5) to eight (8) minutes and then it was ten (10) minutes it was cleared out?

BH It was cleared out and then once it cleared out you started seeing uh the same kind of smoke develop?

GH Uh no we could clearing see black smoke start to form and start to pour out the window.

BH Okay on the diagram here can you tell us where you started seeing black smoke?

GH Uh this peak here okay.

BH Okay.

GH There's a peak on the house here or on the mobile home.

BH Mm hmm.

GH I could start to see smoke uh I don't know if it was coming out of this window, because I couldn't see this window because I couldn't see this window,

BH Mm hmm right.

GH But I could clearly start to see black smoke coming away from the peak, right at the peak, from the angle I was.

BH Okay so it's coming form the number four (4) side?

GH Yes.

BH Okay kind of over the, somewhere on the, by the "B" window, on the number four (4) side?

GH Yes.

BH Okay you started seeing black smoke and this is different than, than the, than the gas that was gas smoke that you saw?

GH Yes clearly and you could see and smell it too, the wind had uh somewhat shifted it towards us you could smell (inaudible) burning,

BH Okay.

GH (Inaudible).

BH Uh between the gas being distributed and uh the smoke where you believe what was occurring, what was occurring from that smoke?

GH I believe there was a fire.

BH There was a fire inside?

GH Fire started (inaudible).

BH Okay at that point did, were did you notify or did someone notify the command post that there was a fire inside, do you remember?

GH I remember, you know I remember, I think I remember,

BH Someone on the radio?

GH Somebody on the radio announced on the there was a fire, black smoke, I think I had gotten on the radio and said you know ninety five (95) that there was clearly black smoke uh coming from the residence.

BH Did the smoke immediately, the black smoke immediately fill the entire house?

GH No, it took,

BH Okay.

GH It took a long time for the smoke to built up.

BH So um it was kind of, just kind of centralized to the number four (4) side?

GH Mm hmm.

BH Um but the other side were clear?

GH The other side were clear.

BH Uh were there any openings that someone could have gone out to surrender once that fire started?

GH Yes there was a, both these windows could have the, the boards in these windows, the glass could have been pulled away, and uh, he uh, or the door, there was a door there that could have been opened, I don't know.

BH From your area there, from where you set up to perform a rescue if someone wanted to give up?

GH We could have yes.

BH Okay. Um even though the fire was going could you have heard someone inside shouting for help?

GH Yes.

BH Shouting that they wanted to give up?

GH Yes.

BH Could you hear the P.A. announcement, uh did anyone make a P.A. announcement?

GH Yes.

BH And then what would that announcement say?

GH The announcement, uh I heard sheriff's, a sheriff's deputy uh on the P.A. speaker saying the building is on fire, the building, it appears to be on fire, come out, you need to come out now, you're not going to be hurt, you're going to be hurt, you're going to get hurt if you stay in the fire, you have to come out, I kept hearing that clearly.

BH Now was that said

GH Pleading for him to come out.

BH Now was that, was that said initially when the black smoke started occurring?

GH Yes.

BH So the house wasn't fully evolved when that announcement was?

GH It was announced, it was announced through out, through out the fire

BH Through out,

GH Through out the fire as it started to build up more and more but initially once that black smoke was observed,

BH Once you saw the black smoke, did you see any movement what so ever through any of the openings.

GH No I did not.

BH Okay. Um did you see any changes from the window covering, did you see uh as far as from a person, not necessarily fire but from any, any person that could have.

GH The only, the only change that I saw uh was when the black smoke started to build up just a little bit thicker but not much, it was just starting to build up, it was had been five (5) minutes or so the, that we'd seen,

BH Mm hmm.

GH Since we'd seen the black smoke um there was this plume of like white, like, it was almost like it almost seem like somebody tried to put out the fire, like it was, it, you could see this puff like instant puff of like almost white smoke come out and roll up with the uh with the black smoke,

BH Okay.

GH To me it appeared, like what was exactly what I pictured in my head was that it, if you were to put out a fire and

BH (Inaudible).

GH If you had a camp fire and you take it and you just dump a cup of water, or a bucket of water on fire it makes a big cloud of uh of not black smoke but almost like a whiter smoke,

BH Okay.

GH Uh that's what it, I saw that (inaudible)

BH Did you hear anything, did you hear anything as far as you know um something being thrown on to a fire like that, that, that steam kind of effect, could you?

GH No

BH Just the (inaudible)

GH But that's just that change, that's what I pictured in my head, I made that noise but that's just what I pictured in my head that's exactly what I saw and that's what I pictured in my head.

BH So black smoke sudden change to a white smoke,

GH White smoke and then

BH It was like steam.

GH That was it and then black smoke build back up again.

BH Okay. Uh from the initial time you saw the black smoke, how long did it take the fire to go through this, this, this residence?

GH I'm not, I didn't look at my watch, but I'd say forty five (45) minutes.

BH Forty five (45) minutes?

GH At least, it was slow, it was the slowest burning fire I've ever seen.

BH If someone was inside and injured and um was calling for help, you believe that you could have heard them?

GH Yes.

BH Okay.

GH Yes I could have clearly heard them.

BH Okay. Um at what point did you leave your position at number four (4)?

GH Once the fire really started to build up

BH Mm hmm.

GH Um and this room was fully engulfed I could clearly see flames through this window and I could start to see the paint uh and things started to the wood start to blister on this window, uh the wind had shifted, and blew smoke towards us, we didn't have any kind of oxygen with us, uh we had tried to use our masks, but it, it couldn't help

BH Mm hmm.

GH So and we were also advised over the radio that there was possibility that the homes propane tank was on the number three (3) side, so based on that circumstances, the fact that we had smoke blowing towards us. Do you want me to slow down, I know you're writing,

BH No, no, I'm (inaudible).

GH (Inaudible). Based on the circumstances of the propane tank where one (1) of us could be injured, um and the smoke rolling towards us we moved back to approximately, a little bit farther, it was, it was farther up here but, and you want me to write a number five (5)?

BH Go ahead.

GH To approximately twenty (20) feet, thirty (30) more feet past that number five (5) uh that way.

BH Okay.

GH And we moved up to a higher position taken (inaudible).

BH So you moved to protect.

GH Protect ourselves (inaudible).

BH Protect yourselves cause you were,

GH (Inaudible).

BH Cause you couldn't see anything else because the smoke was,

GH It was all blowing out the, we could not even make out the side of the building.

BH By the time you moved uh there was fire in number "A", letter "A" letter "B" window and then to the door here?

GH Uh move from here.

BH When you moved from there,

GH Yes.

BH The fire had fully,

GH Fully engulfed "A" and "B", not the door.

BH Not the door?

GH No.

BH And the best you can see that door could maybe function?

BH It appeared to me that it,

BH Okay.

GH Didn't there wasn't like a, that I could see from the angle uh I don't remember looking when I got out but the uh, there was like a porch there but it appeared that it was a side door to a trailer that you could open up I mean

BH Right.

GH You could just, it swung open.

BH Okay so number five (5) when do you leave that position?

GH Uh the fire approximately forty five (45) minutes to an hour after I initially saw the black smoke, we moved back cause the it, the fire became fully engulfed and it was becoming a danger to us.

BH Did you, during the fire did you hear anything coming from inside?

GH I heard uh some muffled cracks, some muffled thumps uh several muffled thumps once the fire had started um and uh,

BH Anything else?

GH I heard ammunition cooking off,

BH Okay.

GH Uh towards the uh once this, one (1) before I had seen flames in "B",

BH Uh huh.

GH And "A" I heard ammunition what appeared to be ammunition keep cooking off, I heard it several times,

BH So you heard,

GH Several of the fires uh to me it sounded like uh a box of ammunition going off and ammunition being heated up and cooked off.

BH So popping?

GH Popping.

BH You heard popping sounds?

GH Yes

BH Okay good.

GH Several popping noise.

BH Okay. Um at any point during this when your um during this uh operation, did you fire your AR-15 (fifteen)?

GH No I did not.

BH Okay. Uh did you fire a handgun and did you fire any gas?

GH No I did not.

BH Okay uh and then um you were once everything was demobilized you went back uh to the command post and did you check out with uh, with any investigators?

GH Yes I did.

BH Okay who did you check out with?

GH You.

BH Okay. That sounds good, is there any other questions?

BS Uh I just had a few things just to clarify for myself, your initial position was passenger door?

GH Passenger side door.

BS You said that was about an hour?

GH About an hour there.

BS Okay and at that point you moved to the drivers side?

GH drivers side door yes.

BS Okay and the other question I had you said at one (1) point you used night vision goggles?

GH Yes.

BS Did you move from that position to use the night vision goggles, where were you at?

GH I stayed right there.

BS (Inaudible) at the car okay.

GH I, I was always at the car. I switched from one (1) side, from the passengers side to the drivers side, on the drivers side we had one (1) officer with a rifle, the other officer was with had the N.V.G.'s.

BS Okay.

GH Was either in the, somewhat in the vehicle looking through the windshield uh at the, that's the angle I was using because I was it's just exhaust, I was exhausted and uh I needed somewhere to support, kind of support myself and then outside.

BS So were you switching off with the goggles or once you had them on, you had them on (inaudible).

GH They were well there wasn't an attachment I was just held them to our face.

BS Right. So you weren't switching with another officer though I mean you weren't

GH (Inaudible).

BS Um and the only (1) other question I had was when you said you could see a figure was that inside at one point (inaudible) I believe from that position?

GH From that position yes, it appeared to be in number in "B".

BS Okay was it a shadow or was it actually like someone walking by the window?

GH I was looking through the N.V.G.'s so I couldn't tell.

BS Okay, okay.

GH To me it appeared, to me it appeared like he was, like he had walked by, that's what it looked like, it looked like he had walked by,

BS Okay.

GH I mean through the N.V.G.'s it's using amplified to,

BS Right, right,

GH Little light to, but see you can't, it's hard to get a descriptions of things.

BS And it was only one (1) time?

GH No there was, it was over uh over at least a uh ten (10) to fifteen (15) minute time frame, twenty (20) minute time frame there, I had seen figures move back and forth. Uh we knew, we had been informed from "A",

BS Right.

GH Uh so we were focused, we had one (1) officer focused on "B" and one (1) officer focused on "A", it concerned me when I saw a figure move from right to left towards "A", because "A" was blacked out

BS Okay.

GH And that's where he had initially fired from so we had uh, so every time I saw a figure move from right to left I'd inform Jones uh who was on or who was observing "A".

BS Was that figure consistent as in I know you can't describe it, I mean (inaudible).

GH It looked like somebody was walking.

BS Look like the same size of them, like there was one (1) that was much bigger than the other?

GH It looked like, it looked like the same size.

BS Okay.

GH Mm hmm.



BS Okay. All I had Bill.

BH Okay um I think that's all I had as well. Let me get another tape. Uh end of the interview at uh 1335.

End of transcript.

Transcribed on 7/9/07 by 0608 [REDACTED].

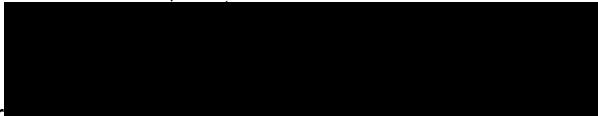
CONSENT TO SEARCH
HUMBOLDT COUNTY SHERIFF'S DEPARTMENT

I,  _____, HAVING BEEN INFORMED OF MY CONSTITUTIONAL RIGHT NOT TO HAVE A SEARCH MADE OF THE PREMISES OR VEHICLE HEREINAFTER MENTIONED WITHOUT A SEARCH WARRANT AND OF MY RIGHT TO REFUSE TO CONSENT TO SUCH A SEARCH, HEREBY AUTHORIZE Det. Schuster _____, AND _____, SHERIFF'S DEPUTIES OF THE COUNTY OF HUMBOLDT, STATE OF CALIFORNIA, TO CONDUCT A COMPLETE SEARCH OF MY RESIDENCE OR VEHICLE LOCATED AT Beary Camp Rd. - Hoopa  _____.

THESE DEPUTIES ARE AUTHORIZED BY ME TO TAKE FROM MY RESIDENCE OR VEHICLE ANY LETTERS, PAPERS, MATERIALS OR OTHER PROPERTY WHICH THEY MAY DESIRE.

THIS WRITTEN PERMISSION IS BEING GIVEN BY ME TO THE ABOVE NAMED DEPUTIES VOLUNTARILY AND WITHOUT THREATS OR PROMISES OF ANY KIND.

WITNESSES:

 _____

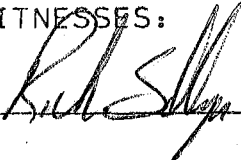
DATED 6/4/02-0105 _____

FILED

JUN 19 2007

SUPERIOR COURT OF CALIFORNIA
COUNTY OF HUMBOLDT

**HUMBOLDT SUPERIOR COURT
COUNTY OF HUMBOLDT, STATE OF CALIFORNIA**

SEARCH WARRANT

S/W # 6304

THE PEOPLE OF THE STATE OF CALIFORNIA, to any sheriff, policeman, or peace officer, proof by affidavit having been made before me by

BEN NORD, DEPUTY SHERIFF

that there is probable cause to believe the property described hereinafter may be found at the locations set forth and that such property is seizable under Penal Code Section 1524 in that it:

- was stolen or embezzled;
- was used as the means of committing a felony;
- is possessed by a person with the intent to use it as a means of committing a public offense; or is possessed by another to whom he may have delivered it for the purpose of concealing it or preventing its discovery;
- is evidence which tends to show a felony has been committed or a particular person has committed a felony;
- is evidence which tends to show sexual exploitation of a child, in violation of Penal Code Section 311.3 has occurred or is occurring.

YOU ARE THEREFORE COMMANDED TO SEARCH:

THE PREMISES located at and described as:

1. [REDACTED] Residence - Latitude [REDACTED] Longitude [REDACTED]. The residence is a singlewide mobile home. It is painted [REDACTED] and has the manufactures name "Westbrook" on it. The mobile home is approximately fifty feet in length and is located

in the Masten Flat area of Hoopa, CA.

Directions: Turn S/B from the Hoopa Outstation non SR-96. Drive .5 miles, turn right onto Loop Rd, drive .5 miles, turn right onto Pine Creek Rd., Drive .1 miles, turn left onto Masten Flats and stay left, road comes to three forks in the road, stay right and drive [REDACTED] to the mobile home.

2. [REDACTED] residence - [REDACTED]
[REDACTED]. A [REDACTED] singlewide trailer with a wooden addition. The trailer is approximately fifty feet in length and twelve feet wide. The addition is 20' by 30' with a wooden roof.

[REDACTED]

Including basements, attics, storage spaces, appurtenant buildings, the surrounding grounds, and any containers thereon which could contain any of the items sought.

FURTHER DESCRIBED AS FOLLOWS: N/A

THE CONTAINER(S) located at and described as: N/A

To effect the arrest warrant of [REDACTED]

THE PERSON(S) OF: [REDACTED]

[REDACTED]
SEX: MALE HAIR: BROWN EYES: BRN HT: 5-11 WT: 185
[REDACTED]

FOR THE FOLLOWING PROPERTY:

- Weapons including but not limited to firearms, ammunition and knives
- Blood and trace evidence
- Fingerprints, palm, foot and shoe prints, latent or otherwise

- Soil and vegetation samples
- Writing of any nature and any kind which appear to have a direct relationship to this incident such as death threats, statements acknowledging responsibility by [REDACTED]
- Items of clothing identifiable to [REDACTED]
- Items of indicia indicating who was in the premises including wallets, purses, letters or other writings, utility company receipts, canceled mail envelopes, business cards, photos, trash bags; vacuum cleaner or implements
- Items which have been touched by [REDACTED] or left behind by him
- Items which appear to contain human blood, human tissues, human or animal hair, or fiber
- Controlled substances and/or items used in the trafficking of controlled substances.

It is further ordered that the peace officers executing this warrant be authorized, pursuant to Penal Code section 1530, to bring onto the premises whatever professional or expert assistants or consultants that he/she considers necessary in order to, among other things, properly preserve the premises and physical evidence, conduct tests, experiments and re-enactments, draw floor plans, and collect physical evidence.

It is further ordered that the peace officers executing this warrant be authorized, pursuant to Penal Code section 1530, to bring onto the premises persons knowledgeable about the premises and/or its occupants, furnishings, and other items of personal property normally found within the premises, in order to, among other things, determine if any items of personal property are missing or otherwise out of place.

It is further ordered that the peace officers executing this warrant be authorized to conduct or order whatever experiments, tests, or scientific evaluations are necessary and proper on said seized items of evidence. All such items shall thereafter be maintained and preserved in an appropriate manner according to commonly accepted policies, standards and appropriate law.

and to seize it or any part thereof and retain such property in your custody subject to order of this court,

pursuant to Penal Code Section 1536.

GOOD CAUSE HAVING BEEN SHOWN BY AFFIANT, you may do the following that bears my initials:

This Search Warrant and incorporated Affidavit was sworn to as true and subscribed before me this 4th day of June, 2007, at 12:08 P.M. Wherefore, I find probable cause for the issuance of this Search Warrant and do issue it.

_____ You may serve this warrant at any time of the day or night, under Penal Code Section 1533.

F.M. Persson Magistrate
Judge of the County of Humboldt Superior Court

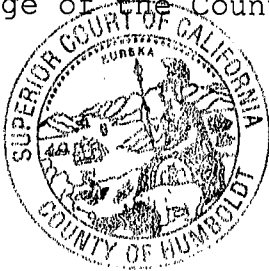

HUMBOLDT SUPERIOR COURT
COUNTY OF HUMBOLDT, STATE OF CALIFORNIA

AFFIDAVIT FOR SEARCH WARRANT
S/W # 6304

FILED
JUN 19 2007
SUPERIOR COURT OF CALIFORNIA
COUNTY OF HUMBOLDT

BEN NORD, DEPUTY SHERIFF, swears under oath that the facts expressed by her in the attached and incorporated statement of probable cause are true and that based thereon she has probable cause to believe and does believe that the property described below is lawfully seizable pursuant to Penal Code Section 1524, as indicated below, and is now located at the locations set forth below. Wherefore, affiant requests that this Search Warrant be issued.

[] was stolen or embezzled;

[X] was used as the means of committing a felony;

[] is possessed by a person with the intent to use it as a means of committing a public offense; or is possessed by another to whom he may have delivered it for the purpose of concealing it or preventing its discovery;

[X] is evidence which tends to show a felony has been committed or a particular person has committed a felony;

[] is evidence which tends to show sexual exploitation of a child, in violation of Penal Code Section 311.3 has occurred or is occurring

and request the issuance of a search warrant to search:

THE PREMISES located at and described as:

1. [REDACTED] The residence is a singlewide mobile home.. It is painted [REDACTED] and has the manufactures name "Westbrook" on it. The mobile home is approximately fifty feet in length and is located in the Masten Flat area of Hoopa, CA.

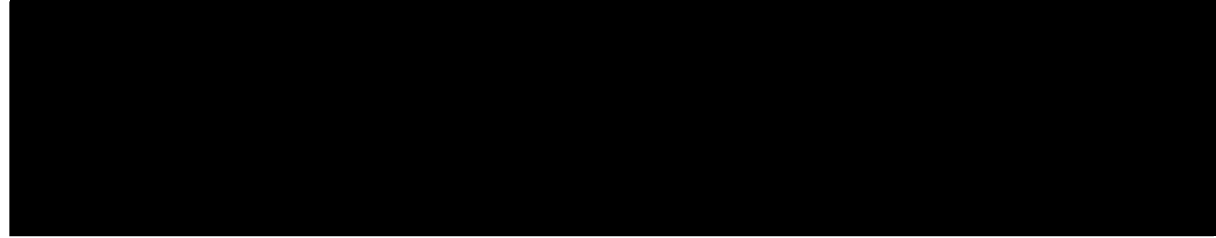

2. [REDACTED]

[REDACTED]. A [REDACTED] trim singlewide trailer with a wooden addition. The trailer is approximately fifty feet in length and twelve feet wide. The addition is 20' by 30' with a wooden roof.

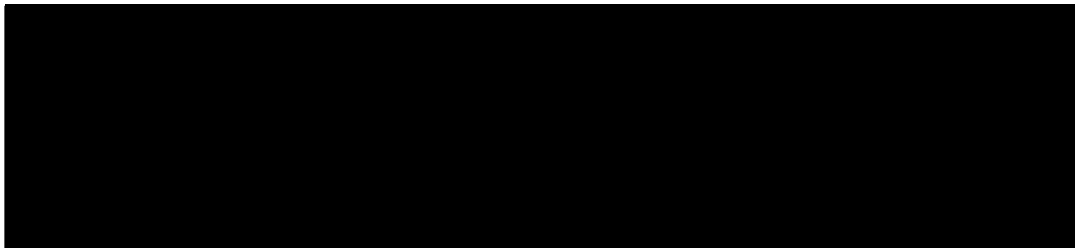

including basements, attics, storage spaces, appurtenant buildings, the surrounding grounds, and any containers thereon which could contain any of the items sought.

FURTHER DESCRIBED AS FOLLOWS: N/A

THE CONTAINER(S) located at and described as: N/A

To effect the arrest warrant of [REDACTED]

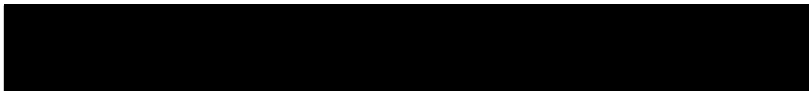

SEX: MALE HAIR: BROWN EYES: BRN HT: 5-11 WT: 185



FOR THE FOLLOWING PROPERTY:

- Weapons including but not limited to firearms, ammunition and knives
- Blood and trace evidence

- Fingerprints, palm, foot and shoe prints, latent or otherwise
- Soil and vegetation samples
- Writing of any nature and any kind which appear to have a direct relationship to this incident such as death threats, statements acknowledging responsibility by [REDACTED]
- Items of clothing identifiable to [REDACTED]
- Items of indicia indicating who was in the premises including wallets, purses, letters or other writings, utility company receipts, canceled mail envelopes, business cards, photos, trash bags; vacuum cleaner or implements
- Items which have been touched by [REDACTED] or left behind by him
- Items which appear to contain human blood, human tissues, human or animal hair, or fiber
- Controlled substances and/or items used in the trafficking of controlled substances.

It is further ordered that the peace officers executing this warrant be authorized, pursuant to Penal Code section 1530, to bring onto the premises whatever professional or expert assistants or consultants that he/she considers necessary in order to, among other things, properly preserve the premises and physical evidence, conduct tests, experiments and re-enactments, draw floor plans, and collect physical evidence.

It is further ordered that the peace officers executing this warrant be authorized, pursuant to Penal Code section 1530, to bring onto the premises persons knowledgeable about the premises and/or its occupants, furnishings, and other items of personal property normally found within the premises, in order to, among other things, determine if any items of personal property are missing or otherwise out of place.

It is further ordered that the peace officers executing this warrant be authorized to conduct or order whatever experiments, tests, or scientific evaluations are necessary and proper on said seized items of evidence. All such items shall thereafter be maintained and preserved in an appropriate manner according to commonly accepted policies, standards and appropriate law.

The following attachments indicated below are incorporated into this affidavit by reference as though set forth here word-for-word; probable cause contained herein:

- (X) Narrative statement of probable cause;
- () The following official police reports and records; and documents, exhibits and photographs;
- (X) State of expertise (and opinion): BEN NORD, DEPUTY SHERIFF

Affiant has reasonable cause to believe that the grounds for the issuance of a search warrant exist based on this affidavit and the above attachments, and prays that a search warrant be issued.

Dated: 6/4/07 Affiant: R M

Subscribed and sworn to before me

John Cassina on this 4th day of June, 2007
Magistrate

Judge ~~CURTIS~~ Humboldt Superior Court

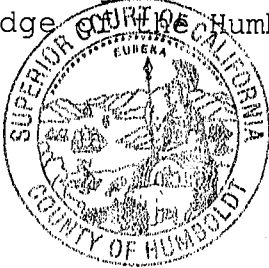

SUSPECT INFORMATION (Photo is attached)

Full name: [REDACTED]

Aliases: [REDACTED]

Res. Add.: MASTEN FLAT

Add.:

Sex: M Race: I Birthdate: [REDACTED]

Hair color: BROWN Eye color: BROWN Height: 5-11 Weight: 185

Driver's license State/No.: [REDACTED]

IN THE SUPERIOR COURT OF CALIFORNIA

COUNTY OF HUMBOLDT

THE PEOPLE OF THE STATE OF CALIFORNIA,

No.:

vs

WARRANT OF ARREST

People v. Ramey (1976) 16 Cal. App. 3d 263

People v. Case (1980) 105 Cal. App. 3d 826

Penal Code section 817

County of Humboldt:

THE PEOPLE OF THE STATE OF CALIFORNIA to any Peace Officer in the State:

Presented by declaration under penalty of perjury having been made this day to me by Detective Marvin Kirkpatrick I find that there is probable cause to believe that the crime(s) of:

PC 664/187 - Attempted Homicide

has / have been committed and accusing the above named: [REDACTED] thereof, YOU ARE THEREFORE COMMANDED forthwith to arrest the above-named individual and bring him / her before me at the courthouse in Eureka, or in case of my absence or inability to act, before the nearest or most accessible magistrate pursuant to Sections 821, 825, 826 and 848 of the Penal Code.

The complaint underlying this arrest warrant does not initiate a criminal proceeding.

Bail is set in the sum of \$ 500,000.

FOR GOOD CAUSE SHOWN, I direct that this warrant may be served at any hour of the day or night.

Dated: 6-4-07 at Eureka, California

Time: 12:07 am / p.m. FAM Cassin

Magistrate
Judge of the Superior Court Of California
County Of Humboldt

CERTIFICATE OF PEACE OFFICER - 26609 GC

I hereby certify that I received the within warrant and that I served the same by arresting the within named defendant on _____ and bringing the defendant before a magistrate of the _____ Court In the County of _____

Booking the defendant at the _____ jail on _____

in the County of _____ Promise to appear issued; pursuant to

853.6/818 P.C. [] Warrant served by _____.

Date: _____ Peace Officer: _____

CERTIFICATE OF PEACE OFFICER - DEFENDANT'S RIGHTS - 821/822 PC

[] I hereby certify that the within named defendant has been informed in writing of his/her right to be taken before a magistrate in the arresting county.

CERTIFICATE OF MAGISTRATE OF ANOTHER COURT - 823 PC

I hereby certify that the defendant named in the within warrant was this day brought before me and that I ordered the defendant be admitted to bail in the sum shown on same warrant.

[] Bail not endorsed on warrant; bail set in the amount of \$ _____

[] Bail given. Appearance date set below.

[] Bail not given. Defendant remanded to custody of _____

[] Defendant released on his/her promise to appear. Appearance date set below.

(Date) (Title and Court) (Signature of Magistrate)

BAIL INFORMATION - PC

Bail: Posted \$ _____ By: _____ Address: _____

APPEARANCE SCHEDULE - 821/822 PC

Date _____ Time _____ COURT HOURS: _____

TRAFFIC: _____

CRIMINAL- Named Court: _____

JUVENILE: _____

RETURN WITHOUT SERVICE - 26609 GC

[] Recalled by Court [] Recalled by Responsible Date _____

**SEARCH WARRANT AND RAMEY WARRANT
STATEMENT OF PROBABLE CAUSE**

On June 3, 2007 at about 2030 hours, I was at my residence when I received a telephone call from Detective Sgt. Hanson. He informed me that there was an officer involved shooting in Hoopa. Detective Sgt. Hanson requested that I stand by in case a search warrant was needed. I did not hear from him the rest of the evening.

On June 4, 2007 at about 0700 hours, I arrived at the Humboldt County Sheriff's Office (HCSO) Criminal Investigation Division (CID) where I met with Detective Sgt. Hanson. He requested that I call Detective Schlesiger on his cellular telephone to obtain the necessary information for a search warrant. I called Detective Schlesiger at 0720 hours and he relayed the following information to me:

On June 3, 2007 at about 1405 hours, the Sheriff's Office was dispatched to check the welfare of [REDACTED] at the [REDACTED] residence on Bloody Camp Rd., Hoopa.

At about 1430 hours, HCSO Deputy Greg Berry and Yurok Tribal Police Department (YTPD) Officer Heather Landreneaux arrived on scene at the residence on Bloody Camp Rd., Hoopa. According to the resident, [REDACTED] came to her residence on Bloody Camp Rd., Hoopa, and was acting strangely. [REDACTED] was talking with her boyfriend of 23 years, [REDACTED] who was at the residence. Detective Schlesiger later found out from [REDACTED] that [REDACTED] had not been at their residence for 6-7 years.

While Deputy Berry and Officer Landreneaux are talking [REDACTED] called on the telephone. Dep. Berry speaks to her and finds out that [REDACTED] was released from [REDACTED] on Friday, June 1, 2007 and that he was still acting strange. Officer Landreneaux and Deputy Berry decided to go to the residence. As they pull up to the residence, they met [REDACTED] on the porch. [REDACTED] brandished numerous knives at law enforcement and verbally threaten them. Deputy Berry and Officer Landreneaux drew their firearms and told [REDACTED] to drop the knives. [REDACTED] went inside the residence.

Deputy Berry asked [REDACTED] if there were firearms inside the residence. [REDACTED] said that he thinks that most

of the firearms are locked up but he does have numerous firearms including an AK-47 in the residence.

At about this time, Deputy Berry and Officer Landreneaux see [REDACTED] in a bedroom window pointing a rifle at them. They retreat and call for back up. As they are retreating, [REDACTED] goes from the window to the door several times. They get into their patrol vehicle and start backing down the driveway. As they are going down the driveway, Deputy Berry and Officer Landreneaux hear the rifle clicking. They are not sure if he is trying to fire to the rifle or working it action.

They retreat back to Bloody Camp Rd., Hoopa were they wait for additional law enforcement assistance. HVTPD Sgt. Ed Guyer, HCSO Deputy Brian Taylor, HVTPD Office Matt Spalino, and CHP Officer Mike Noland arrive on scene. Near the first law enforcement vehicle on the gravel driveway, Officer Spalino and Deputy Taylor were standing with their guns drawn. Near the second law enforcement vehicle was Officer Mike Noland and Sgt. Ed Guyer. There is one window from the residence facing the south side area.

At about 1820 hours, law enforcement see a black rifle barrel pointing in their direction. Several shots were fired from inside the residence striking both vehicles in the windshield area. Deputy Taylor returned gunfire back at the residence. They remained in cover but continued to observe the residence. Officers on scene believed that the firearm was a .22 caliber rifle. The HCSO special enforcement team SET was requested to respond to the location.

At about 1900 hours, HCSO negotiators called the residence in attempt to speak to [REDACTED] [REDACTED] did not answer the phone.

Law enforcement continued to observe the residence; at about 2058 hours additional shots where fired from the residence toward law enforcement. Three deputies from SET returned fire at the residence.

The SET team continued to observe the residence and that last time that they saw movement inside the residence was at about 0500 hours on June 4, 2007.

Detective Schlesiger spoke to [REDACTED] mother of [REDACTED]. She said that one Friday night [REDACTED] stays the night with his brother [REDACTED]. [REDACTED] was acting crazy so [REDACTED] took [REDACTED] to [REDACTED] residence on Saturday. While at her residence, [REDACTED] continued to act strangely. According to his [REDACTED] [REDACTED] has a history of [REDACTED] and has been [REDACTED] with [REDACTED]. When he [REDACTED] [REDACTED]

[REDACTED] also told Detective Schlesiger that she believed that [REDACTED] had access to a .22 caliber rifle. [REDACTED] did not know where this rifle was. She then personally showed Det. Kirkpatrick where [REDACTED] lived.

She called HVTPD and reported [REDACTED] behavior. HVTPD informs her that they are currently busy and that they will respond as soon as they can. [REDACTED] asks [REDACTED] to take [REDACTED] somewhere and that is the last time she knows where [REDACTED] is until [REDACTED] calls her on the telephone. It is unknown how he got to [REDACTED] residence.

[REDACTED] has a violent past including charges of brandishing a deadly weapon, terrorist threats and resisting arrest.

- Refer to [REDACTED] rap sheet:

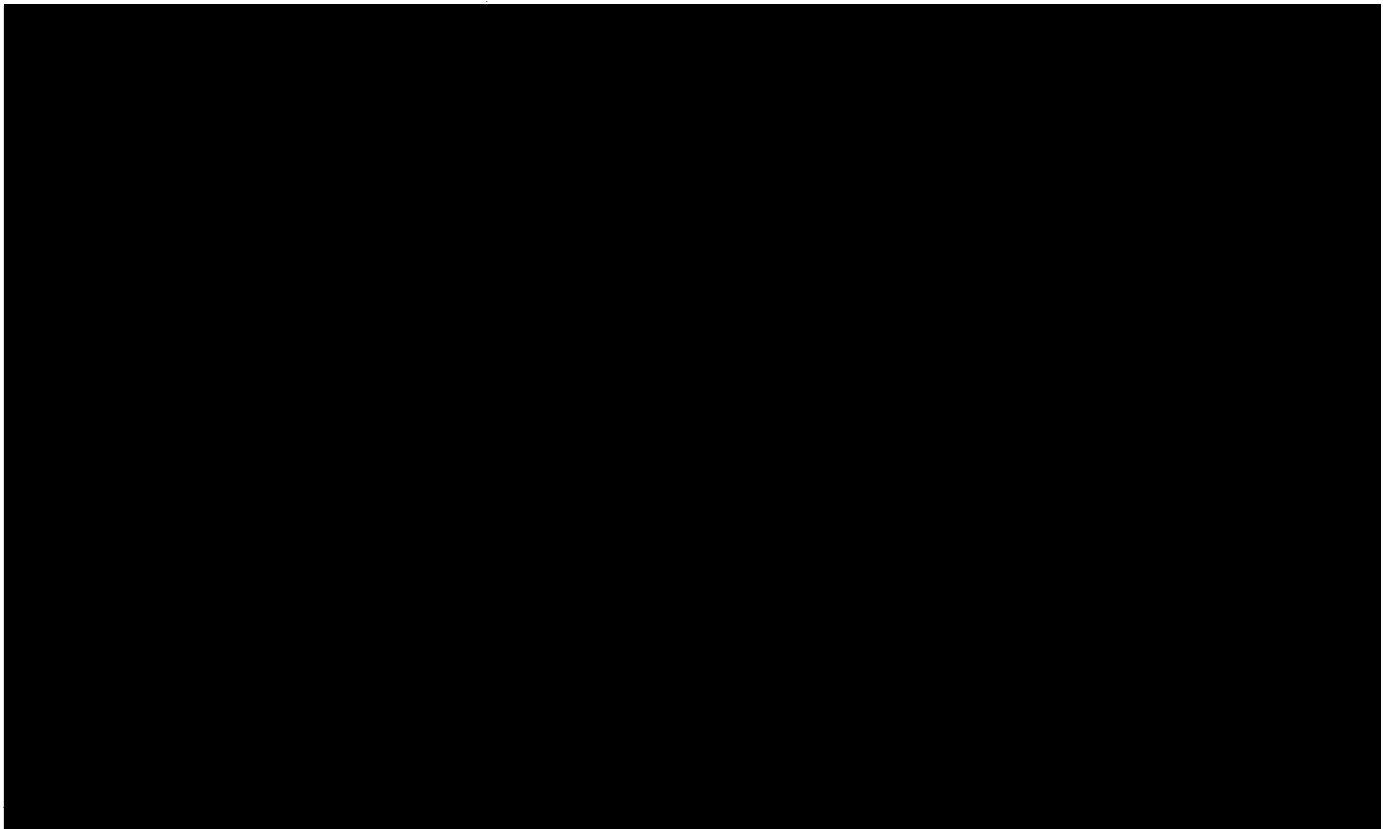

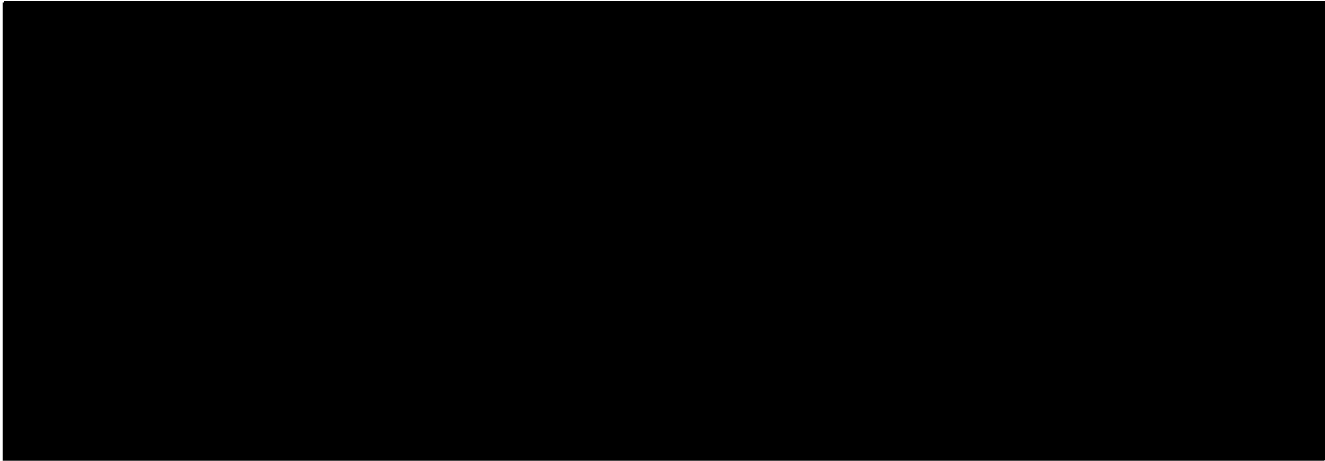

Based on my training and experience, I believe that that [REDACTED] is violent person. Furthermore, there is a high probability that there are firearms and/or weapons at his residence due to his mother's statement. In addition, [REDACTED] residence could contain information that could aid this investigation and help deescalate this situation. [REDACTED] could be [REDACTED] based of his behavior and his residence could show what [REDACTED] he currently is in.

[REDACTED] is currently inside the [REDACTED] residence where he has located additional weapons including several firearms. These firearms were used to shoot at law enforcement officers.

Statement of Expertise Detective Ben Nord

I have been employed in law enforcement for the past 9 ½ years. I was employed as a Police Officer in Lake Shastina for a year and a half (1997-1998) prior to being employed by the Humboldt County Sheriff's Office. I have worked as a Deputy Sheriff since February 22, 1999. I was initially assigned to the Hoopa Out-Station in 1999. I was transferred to Main Station Patrol in 2001. On December 20, 2004 I was assigned to the Criminal Investigation Division (CID) as a Detective.

I base my opinions on the following specialized training and expertise.

1. I successfully completed the Basic Police Academy at the College of the Redwoods. The Academy included training in sexual assault and homicide investigation.
2. In 1996, I received my Associate of Arts (A.A.) degree in General Studies from College of the Redwoods.
3. In 2000, I received my Bachelor of Science (B.S.) degree in Criminology with a minor in Psychology from Southern Oregon University.
4. I have received my POST Basic, Intermediate and Advanced certificates.
5. I have attended a 40-hour POST certified course in child abuse.
6. I have attended a 40-hour POST certified course in sexual assault.
7. I have attended a 40-hour POST certified course interview and interrogation.
8. I have attended a 36-hour OJJDP certified course in Child Sexual Exploitation Investigations
9. I have attended 40-hour POST certified course in Search Warrants
10. I have attended a 80-hour POST certified course in homicide investigations
11. I have investigated numerous felony and misdemeanor cases including but not limited to: murder, attempted murder, rape, child sexual assault, domestic violence, suspicious deaths and missing persons.
12. I served and written search warrants with the Sheriff's Department and other law enforcement agencies.

FILED

JUN 19 2007

COUNTY OF HUMBOLDT, STATE OF CALIFORNIA

SUPERIOR COURT OF CALIFORNIA
COUNTY OF HUMBOLDT

RETURN TO SEARCH WARRANT

NO. 6304

The personal property on the inventory attached hereto was taken from the premises located at and described as:

THE PREMISES located at and described as:

1. [REDACTED]
[REDACTED] The residence is a singlewide mobile home. It is painted [REDACTED] and has the manufactures name "Westbrook" on it. The mobile home is approximately fifty feet in length and is located in the Masten Flat area of Hoopa, CA.

2. [REDACTED]
[REDACTED] singlewide trailer with a wooden addition. The trailer is approximately fifty feet in length and twelve feet wide. The addition is 20' by 30' with a wooden roof.

Including basements, attics, storage spaces, appurtenant buildings, the surrounding grounds, and any containers thereon which could contain any of the items sought.

THE VEHICLE(S) described as: N/A

THE PERSON(S) OF: [REDACTED]

SEX: MALE HAIR: BROWN EYES: BRN HT: 5-11 WT: 185
[REDACTED]

[REDACTED]

pursuant to the search warrant dated the 4thth day of June, 2007, issued by Judge Timothy Cissna of Humboldt Superior Court and executed on January 4, 2007.

I, **Deputy Sheriff Detective Marvin Kirkpatrick**, by whom this warrant was served, do swear that the attached inventories contain(s) a true and detailed account of all the property taken during the service of this search warrant.

All the property seized which was listed on the search warrant will be retained in my custody subject to order of this or any court in which the offense in respect to which the property was taken is triable.

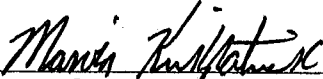

Deputy Sheriff/Detective Kirkpatrick

GIVEN under my hand and dated
this 19 day of June, 2007.



Deputy Clerk of the Humboldt Superior Court.

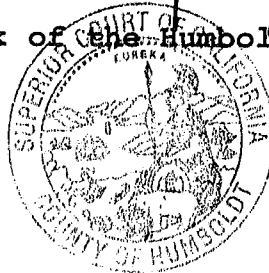

SEARCH WARRANT INVENTORY

DATE ITEMS REMOVED 6-5-07 CASE NUMBER 200703162

DEPUTY SHERIFF SEIZING ITEMS M. KIRKPATRICK 0583 SEARCH WARRANT NUMBER N/A

ITEMS REMOVED FROM ADDRESS/LOCATION RESIDENCE

- #4 ~~28~~ 37mm GAS SHELLS - EXPENDED ROADWAY NEXT TO HOUPA VEH
- #7 12 GA EXPENDED BARRICADE PROJECTILES INSIDE FRONT AREA OF HOUPA VEH
- #8 12 GA EXPENDED BARRICADE PROJECTILES ROADWAY NEXT TO HOUPA VEH
- #1 12 GA EXPENDED BARRICADE PROJECTILES COLLECTED 6-4-07
- #1 223 EXPENDED SHELL ROADWAY NEXT TO HOUPA VEH
- #2 223 EXPENDED SHELL " " " "
- #3 223 EXPENDED SHELL " " " "
- #5 9mm STARS ROUND EXPENDED COLLECTED 6-4-07
- #6 223 EXPENDED SHELL ROADWAY NEXT TO HCSO VEH - B. TAYLOR
- #10 CS PROJECTILE EAST SIDE OF RES.
- #11 MAGAZINE - EMPTY UNDER S/E CORNER OF RES
- #20 CS PROJECTILE EAST SIDE OF RES
- #9 CS PROJECTILE SOUTH OF RES.
- #10 12 GA BARRICADE PROJECTILE SOUTH OF RES
- #11 12 GA BARRICADE PROJECTILE SOUTH OF RES
- #12 12 GA BARRICADE PROJECTILE SOUTH OF RES
- #13 12 GA BARRICADE PROJECTILE SOUTH OF RES
- #14 37mm ~~BRASS~~ ^{EXPENDED} GAS PROJECTILE SOUTH OF RES
- #15 45 CAL EXPENDED SHELL SOUTH OF RES
- #16 PIN TO CHEMICAL AGENT CONTAINER SOUTH OF RES.

DATE 6-5-07 TIME 1640 HRS SIGNATURE OF DEPUTY SHERIFF M. Kirkpatrick PIN # 0583

DISTRIBUTION: ORIGINAL - LEAVE AT SCENE OF SEARCH WARRANT SERVICE YELLOW - RETURN TO COURT WITH ORIGINAL SEARCH WARRANT

SEARCH WARRANT INVENTORY

DATE ITEMS REMOVED 6-5-07

CASE NUMBER 200703162

DEPUTY SHERIFF SEIZING ITEMS M. KIRKPATRICK 0583

SEARCH WARRANT NUMBER N/A

ITEMS REMOVED FROM ADDRESS/LOCATION [REDACTED] RESIDENCE [REDACTED]

#17	PEN TO CHEMICAL AGENT CONTAINER	SOUTH OF RES.
14A	SPOON TO CHEMICAL AGENT CONTAINER	SOUTH OF RES.
#21	37mm CS PROJECTILE	SOUTH WEST OF RES.
#22	EXPANDED .22 LR SHELL	FRONT OF RES NEAR STEPS
#23	37mm CS PROJECTILE (CAN)	UNDER [REDACTED] FORD T-BIRD IN DRIVEWAY
#24	37mm CS PROJECTILE LEVE (CAN)	NORTH OF RES.
#25	EXPANDED .22 CAL SHELL	" " "
#26	37mm CS PROJECTILE LEVE (CAN)	" " "
#27	37mm CS PROJECTILE LEVE (CAN)	" " "
#26A	37mm CS PROJECTILE LEVE (CAN)	" " "
#28	EXPANDED 37mm CS PROJECTILE	" " "
#29	37mm CS PROJECTILE LEVE (CAN)	" " "
#30	37mm CS PROJECTILE LEVE (CAN)	" " "
#31	37mm CS PROJECTILE LEVE (CAN)	" " "
#32	37mm CS PROJECTILE LEVE (CAN)	" " "
#33	EXPANDED CS PROJECTILE	" " "
#34	.45 CAL EXPANDED SHELL	" " "
#35	.45 CAL EXPANDED SHELL	" " "
#36, #37, #38	.45 EXPANDED SHELLS	" " "

DATE 6-5-07

TIME 1640 HRS

SIGNATURE OF DEPUTY SHERIFF M. Kirkpatrick

PIN # 0583

DISTRIBUTION: ORIGINAL - LEAVE AT SCENE OF SEARCH WARRANT SERVICE YELLOW - RETURN TO COURT WITH ORIGINAL SEARCH WARRANT

SEARCH WARRANT INVENTORY

DATE ITEMS REMOVED 6-5-07 CASE NUMBER 200703162

DEPUTY SHERIFF SEIZING ITEMS M. Karpatrik 0583 SEARCH WARRANT NUMBER N/A

ITEMS REMOVED FROM ADDRESS/LOCATION [REDACTED] RESIDENCE [REDACTED]

- #39 37mm CS SHELL - LIVE
EXPANDED FOUND ON PROPERTY EN DREWEWAY
- #40 37mm CS PROJECTILE SOUTH OF RES.
- #41 1-45 EXPANDED SHELL
#5-223 EXPANDED SHELLS - EAST WALL -
INSIDE OF RES - DINING ROOM
- #42 MACHETE BLADE SOUTH EAST CORNER OF RES.
- #43 SPENT GAS CANISTER - CHEMICAL AGENT - DINING ROOM
- #44 MAGAZINE - EMPTY DINING ROOM
- #45 20 EXPANDED 37mm CS SHELLS NORTH EAST OF RES.
- #46 CS 75mm PROJECTILES² - LIVE (CAN) NORTH WALL
- #1-5 FIREARM BARRELS, 4 KNIVES LEVING ROOM
- 1 - GERMANIC BODY, 1-5 WARD, 6 - MAGAZINES
- #48 SPRING ARMORY 1911-A1 [REDACTED] TOP OF TOILET TANK
MAG (LOADED 7 ROUNDS) - NONE IN CHAMBER
- #49 CS CANISTER (CHEMICAL AGENT) SOUTH WEST BED ROOM
- #50 CS EXPANDED PROJECTILE MASTER BED ROOM
- #51 KNIFE - LARGE KITCHEN AREA
- #52 RED SHIRT & SHORTS BATHROOM FLOOR

DATE 6-5-07 TIME 1640 HRS SIGNATURE OF DEPUTY SHERIFF M. Karpatrik PIN # 0583

DISTRIBUTION: ORIGINAL - LEAVE AT SCENE OF SEARCH WARRANT SERVICE YELLOW - RETURN TO COURT WITH ORIGINAL SEARCH WARRANT

SEARCH WARRANT INVENTORY

DATE ITEMS REMOVED 6-4-07 CASE NUMBER 200703162

DEPUTY SHERIFF SEIZING ITEMS M. K. KAPLAN 0583 SEARCH WARRANT NUMBER N/A

ITEMS REMOVED FROM ADDRESS/LOCATION DIAGNOSTIC FLATS GPS [REDACTED]

#1 7 PRESCRIPTION BOTTLES KITCHEN TABLE
FOR [REDACTED] (2006 & NO REC'D)

#2 INDICIA CAR KITCHEN TABLE

#3 PAPER BOWL CONT TOP SHELF OF BEDROOM
MISC. AMMO. CLOSET

#4 INDICIA CAR TOP SHELF OF BEDROOM
(2005) CLOSET

6-4-07 1:40 PM M. Kaplan 0583
DATE TIME SIGNATURE OF DEPUTY SHERIFF PIN #

DISTRIBUTION: ORIGINAL - LEAVE AT SCENE OF SEARCH WARRANT SERVICE YELLOW - RETURN TO COURT WITH ORIGINAL SEARCH WARRANT



**HUMBOLDT COUNTY DISTRICT ATTORNEY'S OFFICE
INVESTIGATION REPORT**

DATE: 06-11-2007

[REDACTED]

[REDACTED]

State of California

CASE: **HCSO 2007-03162**

DOCKET:

OFFENSE: **PC 664/187**

WITNESSES:

[REDACTED]

[REDACTED]

[REDACTED]

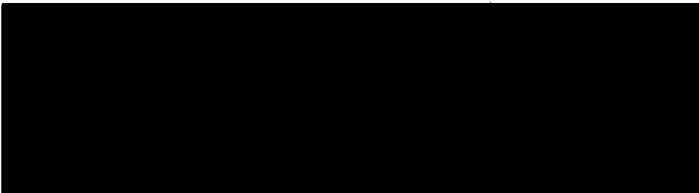

SUMMARY:

On 06-03-2007 at approximately 2000 hrs., I received a telephone call from Det. Wayne Hanson. Hanson told me the Sheriff Office responded to a barricaded [REDACTED] that had shot at deputies. Deputies had returned fire, but it did not appear anyone had suffered any injuries. The incident was taking place on Bloody Camp road just outside of Hoopa.

NARRATIVE:

I contacted Investigator Dunn, via telephone, and advised him of the situation. I had him meet me at my residence and we responded to Hoopa in one vehicle. When we arrived we spoke to Lt. Knight. Lt. Knight told us at approximately 1530 hrs. a [REDACTED] had barricaded himself in a friend's house and had fired several shots at law enforcement. Lt. Knight also advised [REDACTED] was suffering from a [REDACTED] and had just been released [REDACTED] on Friday (06-01-07).

At this point Investigator Dunn and I were assisting with taking witness statements and observing the incident. At approximately 0200 hrs, Lt. Cavinta made the decision to secure the scene and take no further action until the following morning. At that point Investigator Dunn and I left the scene and returned to Eureka.

We responded back to the scene on 06-04-07 at approximately 0930 hrs. I teamed up with Det. Hanson and tried to find additional witness. We were unable to locate any additional witnesses at that time.

Once the incident was over Investigator Honsal, Det. Quenell and I were assigned to photograph the tactical teams, record the serial numbers off of their weapons and perform an ammunition check. I photographed most of the tactical team members and helped record serial numbers. Refer to Investigator Honsal's report for further details.

Investigator Honsal and I then transported the four deputies that fired their weapons to St. Joseph hospital for a legal blood draw. Starting at 1930 hrs. lab techs [REDACTED] and [REDACTED] withdrew blood samples from deputies, Jaime Barney, Brain Taylor, Brain Quenell and Tony Gomes. Investigator Honsal and I witnessed the blood samples being taken, took possession of the samples and labeled them. I deposited the samples in the refrigerator at the HCSO investigative unit. I secured the refrigerator with evidence tape.

On 06-05-07 at approximately 1130 hrs, I drove back to Hoopa and assisted Investigator Cox in diagramming the scene with the Total Station. Refer to his report for further details.

I was assigned the above witnesses to contact in regards to this case. The following are a summary of their statements:

Officer Mckillip told me he was on duty when the call first came out on Bloody Camp road. At the time the call came out he was on Bald Hills road almost to Weitchpec. He heard Q40 (Deputy Greg Berry) ask for a "back" because the [REDACTED] had armed himself with a knife. Officer Mckillip immediately turned around and proceeded to the scene. When he arrived he helped set up a perimeter on the east side of the residence. While he was at that location he could hear the [REDACTED] inside yelling. He occasionally could see the [REDACTED] through the kitchen window, but could not see if he had a weapon. At approximately 1800 hrs., Mckillip heard the [REDACTED] shoot, what he thought was a small caliber rifle at the deputies. One of the law enforcement officers returned fire, shooting one round.

Officer Mckillip maintained his position until 2000 hrs. when the [REDACTED] fired his rifle out of the south/east corner window of the residence. One of the rounds went right passed Officer Mckillip's head. The HCSO SET team returned fire, shooting several rounds. At that point Mckillip returned to his vehicle for better cover. He was relieved of his position on the perimeter at approx. 2330 hrs. He stayed on scene until I interviewed him.

Officer Mckillip told me he never fired his weapon, nor did his partner, Officer McCovey. I examined both of their weapons and ammo. It appeared nether officer had fired their weapon and they both had a full complement of ammunition. The following is a description of the officer's firearms.

Officer Mckillip Glock 22, .40 cal., Ser. [REDACTED]
 Remington 870, 12 ga., [REDACTED]

Officer McCovey Sig Sauer, .40 cal, Ser. [REDACTED]

On 06-05-07 at approximately 1245 hrs., I spoke to [REDACTED] at his residence off of Bloody Camp Rd. [REDACTED] is the owner of the property were the incident took place and lives approximately 400 yards away from the residence that [REDACTED] barricaded himself.

[REDACTED] told me at approximately 1530 hrs., he received a telephone call from a friend telling him to lock his doors and stay inside because someone had barricaded themselves inside of the trailer just down the road. Sometime in the evening [REDACTED] heard three gunshots.

█████ said he new █████ █████ but had not seen him for three or four years. The last time he had contact with █████ he seemed to be a "pretty good kid."

A few weeks ago █████ had told █████ that █████ was over at his house and was acting "very weird."

On 06-07-07 at 1005 hrs., I spoke to █████ at her office (█████ Eureka). █████ is the █████ coordinator for the County. She told me on 06-03-07 at approx. 1900 hrs., she received a telephone call from her boss, █████ told her a █████ █████ had barricaded himself in a house and was shooting at police officers. █████ drove over to █████ residences, pick her up, and they drove to Hoopa. On the way up to Hoopa they decided that █████ would deal with █████ family and █████ would deal with law enforcement.

When they arrived █████ met with █████ family. █████ mother, █████ told █████ █████ was barricaded in the house and had shot at the police officers. She was very concerned for █████ because he was acting strange. The Family told █████ that █████ had █████. He was █████.

█████ told the family the Sheriff Office was trying everything they could to end the situation peacefully. The family was concerned there were too many police officers at the scene. █████ then gathered information from the family that the negotiators could relay to █████ during the negotiation process.

█████ then tried to gather information on the Native American culture that the negotiators could use.

█████ obtained food from the Sheriffs Office and gave it to █████ family. █████ was on scene on 06-03-07 at 1900 hrs. to 0300 hrs. She returned at 0800 hrs. and remained on scene until approx. 1600 hrs.

█████ told me law enforcement did everything they could to bring this situation to a peaceful end. Refer to █████ taped statement for further details.

On 06-07-07 at approx. 1305hrs., I spoke to █████ at her office located at █████ Street in Eureka. █████ is a supervisor for Humboldt County █████. On 06-03-07 at approx. 1630 hrs., █████ contacted Lt. Knight in regards to an incident the Sheriff Office was having in Hoopa. Lt. Knight told █████ they had a █████ barricaded in a house and had shot at deputies. █████ picked up █████ at her residence and they both drove to the scene. When they arrived they tried to comfort the family. █████ called █████ and discovered █████ had just been █████ 5-30-07. See also learned █████ █████

█████ continued to comfort the family. She explained to them that they could not go speak to █████ in person for fear of a hostage situation. When the fire started the

family seemed to understand that the fire trucks could not immediately come in due to all of the ammunition that was exploding.

█████ told me she was very impressed with the law enforcement on the scene. She said they did everything they could to resolve this situation peacefully. █████ left the scene at 1630 hrs. with █████ Refer to her tape statement for further details.

On 06-07-07 at approx. 1100 hrs., I spoke to █████ at the Hoopa Police Department. █████ was the dispatcher on duty at the time the █████ incident occurred. █████ told me on 06-03-07 at 1033 hrs. █████ mother called the police department and asked for a welfare check on her son. She told █████ that █████ was talking to imaginary cats. █████ dispatched Officer Mike Roberts to look for █████ Roberts checked several places but was unable to locate █████ At 1354 hrs., █████ mother called Hoopa PD back and told them █████ was at █████ residence and was attempting to █████

█████ dispatched the Sheriff office to the residence. When the Sheriff Office arrived the incident was handed over to the Sheriff Office dispatch. At 1532 hrs., the deputies on scene requested back-up from Hoopa PD because █████ was pointing a gun at them.

█████ gave me a copy of his dispatch logs that outlined the incident. Refer to the attached copy. Also refer to █████ taped statement for more complete details.

On 06-12-07 at approx. 1000 hrs., I spoke to █████ via telephone. He told me he was one of the first EMT's on scene at the Hoopa incident. On 06-03-07 at approx. 1500 hrs., he and his partner, █████, were dispatched to Bloody Camp road and staged at the entrance to the █████ property. At about 1730 hrs. █████ heard three shots fire from the vicinity of the █████ property. At approx. 2100 hrs. █████ heard on the scanner additional shots were fired, but due to being inside the ambulance and having the windows rolled up he did not physically hear the shots. █████ stayed on scene until 0300 hrs. and then was rotated out.

On 06-12-07 at approx. 1330 hrs., I spoke to █████ who was █████ partner in the ambulance during the incident. █████ said they were dispatched to Bloody Camp road and staged at the entrance to the █████ property. At one point, he heard a few gunshots, but could not remember when the shots occurred. They stayed on scene until 0300 hrs. and then were relieved. █████ said he pretty much stayed inside the ambulance so he did not see or hear much.

Date Printed: 7/23/2007
Time Printed: 2:54:24PM

Hoopa Valley Tribal Police Department Call Detail Report

Date of Call	Address	Type of Call	Primary Car	Disposition/CN
06/03/2007		WELFARE CHECK	2505	ATL 25071433
Additional Information: [REDACTED]				
Time Call Received:	06/03/2007	Not Self-Initiated	Primary Unit Dispatched	
Time Dispatched:	1042			
Time Started to Call:				
Time Arrived:	1108			
Time Finished:	1121			
Officer On Call:	[REDACTED]			
Call Notes:	R/P REQUEST WELFARE CHECK ON [REDACTED]			
	[REDACTED]			
	1042-05 DISPATCHED			
	1108-05 OUT			
	1117-05 ATL SUB			
	1120-05 OUT [REDACTED] RES			
	1121-05 CLEAR			

Date Printed: 7/23/2007

Time Printed: 4:35:22PM

Hoopa Valley Tribal Police Department Call Detail Report

Date of Call	Address	Type of Call	Primary Car	Disposition/CN
06/03/2007	[REDACTED]		2501	DOCUMENTATION 25071434
Complainant/Caller: [REDACTED]				
Additional Information: R/P [REDACTED]				
Time Call Received:	06/03/2007	Not Self-Initiated	Primary Unit Dispatched	
Time Dispatched:				
Time Started to Call:				
Time Arrived:				
Time Finished:	1800			
Officer On Call:	CHIEF HOSTLER			
Call Notes:	<p>1354-R/P REPORTS [REDACTED] IN THE [REDACTED] RES ATTEMPTING TO [REDACTED] AND WANTS WELFARE CHECK ON [REDACTED] BALD HILL RD ON [REDACTED] PROPERTY [REDACTED] TRAILER LEFT SIDE AT 2 WHITE POST WITH [REDACTED] WRITTEN ON THEM 1402-HCSO DISPATCHED 2505 TRANSPORTING TO HCY 1532-HCSO ADVISED THAT [REDACTED] IS IN RES WITH GUN POINTING GUN AT S/O OFFICER REQUEST BACK UP 2505 DISPATCHED 1535-01 CONTACTED DISPATCHED 1537-03 CONTACTED DISPATCHED 0058 03 ENROUTE O.D. NOTE: [REDACTED] 0130 ALL UNITS OFF SCENE 1540-06 UNABLE TO CONTACT 1545-CONTACT HCSO UPDATE-HCSO ADVISED THAT [REDACTED] IS STILL UNCOMPLIANT AND UNCOOPERATIVE [REDACTED] WEARING BLUE JEANS SLEAVLESS WETSUIT AND RED BANDANA 1555-01 REQUEST MEDICAL TO SATND BY 1555-81 DISPATCHED 1558-06 UNABLE TO CONTACT 1559-04 CONTACTED DISPATCHED 1601-CONTACTED HCSO UPDATE OFFICERS 2501 2503 DISPATCHED-HCSO ADVISED THAT S.W.A.T, AND NEGOTIATION TEAM 49 1603-81 49 1603-82 DISPATCHED FOR COVERAGE 1614-81 OUT 1623-06 UNABLE TO CONTACT 1623-05 OUT WITH NUMEROUS SUBS IN AREA ADVISED TO LEAVE OR WILL BE ARRESTED 1644-04 IN VALLEY 49 TO ADVISE 06 1652-06 ADVISED 1701-04 OUT 1715-06 10-8 1740-05 ADVISED MOVEMENT ON NORTH SIDE BACK WINDOW 1825-SHOTS FIRED 1830-87 IN COMMAND 1833-SHOTS RETURNED BY S/O OFFICERS O.D. BETWEEN 0100 AND 0130 0730 - 6/4 01 BACK IN OFFICE, WILL BE ENROUTE TO COMMAND POST AT 0800 0806- 2503 [REDACTED] 0810- 01 [REDACTED] 0828- 01 REQUESTING VOLUNTEERS 0936- HVFD 10-97 1003- 01 REQUESTING A ALS MEDI-VAC TO HOOPA AIRPORT 1007- REACH 6 ETA 1312 1040- PER CDF REACH DECLINED AND CHP 1100- HSO COMMAND POST [REDACTED] IF REQUESTED THE LZ WILL BE HOOPA AIRPORT OR LAT [REDACTED] 1327- 01 REQUESTED A UNIT TO RESPOND TO BALD HILL AND REMOVE [REDACTED]</p>			

Date Printed: 7/23/2007

Time Printed: 4:35:23PM

Hoopa Valley Tribal Police Department Call Detail Report

1856- 04 OUT BALD HILL

1944- 04 REQUESTING 05-06 RESPOND TO BALD HILL TO DRIVE UNIT BACK DOWN

1950- VE-3 VE-4 CONTAINED CONTROLLED MOPPED UP WILL BE SMOKE, RETURNING

2004 2501 REQUESTS ENGINE RESPOND BACK TO FIRE, THERE IS SOME FIRE STILL IN THE ATTIC AND
NEED TO PRESERVE THE SCENE

2004 PAGED VOLS TO RESPOND

2006 PAGED AGAIN, NO RESPONSE

2008 VOL. 10 WILL RETURN // ADVISED OF NEED TO RESPOND BACK

2014 VOL 1 ADVISED THAT ENGINE 3 AND 4 WILL RETURN TO QUARTERS TO RESTOCK, THEN ENGINE
4 WILL RETURN TO SCENE

2025 HAVE VISIBLE FLAME ON EAST SIDE OF STRUCTURE

2037 ENGINE 4 ON SCENE

2045 01 O.D.

2148- ENGINE 4 CLEAR. ENROUTE BACK TO F.H.

NOTE: 04 WILL STAY ON SCENE FOR THE NIGHT 6/4/07 UNTIL 01 RELIEVES HIM AT 0700 HOURS

6/5/07 0800- 04 OD

0807- 01 BACK OUT BALD HILL

1628- 05-02 AND 01 49 TO BALD HILL TO PICK UP THE UNITS AT THE CRIME SCENE

ALL OFF THE HILL



HUMBOLDT COUNTY DISTRICT ATTORNEY'S OFFICE INVESTIGATION REPORT

DATE: July 3, 2007

CASE: [REDACTED] State of California
200703162 (HCSO)

DOCKET:

OFFENSE: PC664/187

BY: 
DA Investigator Wayne Cox

REPORT:

On 06-03-07, the Humboldt County Sheriff's Department and the Yurok Tribal Police Department became involved in a "stand-off" with [REDACTED] [REDACTED]. During the incident, [REDACTED] shot at the Deputies/Officers. At some point during the stand-off, the residence where [REDACTED] had barricaded himself became engulfed in flames. [REDACTED] did not exit the residence and was later found deceased in the bathroom of the residence. Refer to additional reports for more complete details.

On 06-04-07, Chief Investigator Hislop and I drove to the residence, located on Bloody Camp Road in Hoopa. At the request of the HCSO, we documented the scene with a Nikon "Total Station" system.

During this process, I operated the Nikon "Total Station" transit system. Chief Investigator Hislop assisted me by positioning the target pole. Measurements for placement at the scene were the evidence items identified by HCSO Evidence Technician [REDACTED] as well as scene geography (ie: roadway/driveway measurements, residence measurements, vehicle measurements, etc.).

All measurements, which were based on the Total Station's "0", are documented in the attached "Measurement Data Log". A diagram, which incorporates an aerial photograph of the scene, is also included with this report. The photograph was taken on 06-05-07 from a USCG helicopter and accurately represents the scene as it appeared at the time of the incident.

Disposition: Nothing further at this time.

INTERVIEW WITH [REDACTED]
Q=Chief (Michael Hislip)

- 1
2
3
4
5
6
7
8
9
10
11
12 Q: This is Chief (Hislip) from the Humboldt District Attorney's Office. I'm at uh,
13 [REDACTED] 5th Street interviewing [REDACTED] in regards to the incident that
14 uh, happened up in Hoopa. Today's date is June 7th and the time is 10:05. Uh
15 [REDACTED] what time were you called up to the scene?
16
17 A: It was in the evening on Sunday. But I'm not positive of what time.
18
19 Q: Late evening or was it...
20
21 A: You know, dinner...
22
23 Q: So, six or seven?
24
25 A: Somewhere around there.
26
27 Q: And who- did you receive the call from dis- uh, Humboldt County Sheriff's
28 Department's Dispatch or?
29
30 A: No. My supervisor ([REDACTED])
31
32 Q: And what did she tell you?
33
34 A: She told me there was a- there was a CIT incident up in Hoopa and uh, we
35 needed to go up and respond.
36
37 Q: What's CIT stand for?
38
39 A: Crisis Intervention Team.
40
41 Q: Okay.
42
43 A: She said um, that Dispatch had requested us.
44
45 Q: Okay. Did the uh, did she relay any- any of the- what was going on at Hoopa?

46
47 A: Um, on the way up we talked.
48
49 Q: Okay. So, did you travel up with your supervisor?
50
51 A: Yes.
52
53 Q: That was [REDACTED] Is that correct?
54
55 A: Yes.
56
57 Q: Okay. And uh, so did you drive over to her house or did she come pick you
58 up?
59
60 A: She came and picked me up.
61
62 Q: Okay. Um, so what did she tell you on the way up there?
63
64 A: She said um, that ([REDACTED] [REDACTED] was um, in a house, had been uh, shooting at
65 officers- let's see. What else did she say. The officers were trying to figure out
66 how to talk with him. They were hoping to be able to talk him out. She
67 thought they said something about [REDACTED] or I don't remember.
68
69 Q: Okay.
70
71 A: Probably- but that was the gist of the conversation between she and I. And
72 then we made plans about what we would do once we got there.
73
74 Q: And what were the plans?
75
76 A: Well, I've been working with the folks up in the valley for about 15 years so I
77 know my way around the valley and I know a lot of the community members.
78 Um, I was going- the plan would be that she would deal with the officers and
79 um, I would interact with the family. And of course our goal is always to
80 provide assistance to both law enforcement and the peripheral family that's
81 out. And we follow- we basically don't have an agenda but following
82 directions.
83
84 Q: Okay. So, once you got to the scene, did you carry out those plans?
85
86 A: Yes.
87
88 Q: Okay. Um, so then you dealt with the family?
89
90 A: Yes.

91
92 Q: So, then can you tell me uh, who you talked to and what did-what did- what
93 kind of assistance you provided.
94
95 A: I talked with- you know, the first thing I did was talk with [REDACTED] ...
96
97 Q: That...
98
99 A: [REDACTED] And [REDACTED] brother. And the step father. And I'm
100 not sure what his name is. Nice guy though. And the officers directed me to
101 the car cause it was just very dark up there.
102
103 Q: Yes.
104
105 A: Very, very dark. So, you really couldn't see much until you were...
106
107 Q: Okay, so what did you then? What kind of assistance- did you tell them what
108 was going on or?
109
110 A: The first thing I did- I didn't really have much information from the officers. I
111 wanted to meet with the family and see if they were okay. So, I know the
112 mom from other situations. Um, and from working up in the valley for 15
113 years, so I went and I gave her a hug. Um, asked them what was going on. Uh,
114 they told me that [REDACTED] was in the house and not coming out. That he had
115 fired shots uh, earlier in the evening. That a welfare check had been requested.
116 They felt he needed to go back [REDACTED], that he was- [REDACTED]
117 [REDACTED] was out of control. Um, so I just basically let them tell me what was
118 going on. Um, they were concerned- very concerned and wanted to know
119 what would happen. They told me that um, law enforcement had circled and
120 that [REDACTED] was probably afraid- afraid to come out and probably regretting
121 everything, but did want to come out. They wanted to know if they could talk
122 with him. Um, I told them I would go try and find out what I could find out.
123
124 Q: Okay, so they told you that they called for a welfare check on- on [REDACTED]
125
126 A: They said that, you know- somebody had called for a welfare check. Or a
127 welfare check was called.
128
129 Q: But they didn't do it?
130
131 A: You know, I don't know what they said.
132
133 Q: Okay.
134

135 A: I really don't. I'm sorry. I do know that um, what they said was something
136 about this started out- we asked for a welfare or this was supposed to be a
137 welfare check...

138
139 Q: Uh-hmm.

140
141 A: I don't remember how it was phrased.

142
143 Q: Okay. But- did they say they were concerned for his [REDACTED]

144
145 A: Yes.

146
147 Q: And- and did they say that they thought he needed to go back to
148 [REDACTED]

149
150 A: Yes.

151
152 Q: Did they say why?

153
154 A: Because he was [REDACTED]

5
156 Q: Okay. And was this- here, hold on one minute. So, they said he was [REDACTED]
157 and [REDACTED]. Were- was he having some of those episodes prior to going in
158 the house? Did they have any contact with him that day?

159
160 A: They said- you know, I don't know about that. They said that he had been
161 acting strange for a while and that they had um, you know everyone had
162 wanted him to go to [REDACTED] and he had been at [REDACTED]. And I
163 don't remember when they had said he had been at [REDACTED].

164
165 Q: Uh, did they relay to you at all any kind of [REDACTED] that he had? Or if
166 he was on [REDACTED]

167
168 A: You know, they said he has [REDACTED]. And we
169 didn't talk about [REDACTED] I didn't talk about that with them. Later, on um,
170 Monday I asked them if they knew if he'd been [REDACTED]. But that was
171 on Monday. And they said they didn't think he had been.

172
173 Q: Did they say what kind of [REDACTED]

174
175 A: No.

176
177 Q: All right, so after you initially talked to the family, and...
178

179 A: Hold on a second. [REDACTED] Hi. Is he okay? Uh-huh. So, he's going back to
180 the [REDACTED] Okay. Which arm is it? Is it- okay. It's the one that's not working
181 right? It- did you guys get him an IV? Okay. All right. Because he had a
182 swollen area when he was in the hospital before on the right arm and it went
183 down, so I'm glad you sent him over. But I think it was an IV site on the left
184 arm from yesterday morning? Oh, dear. Okay. Okay. Well, I'm doing a- a
185 little thing right now and when I'm done with this, I'll probably go over to the
186 [REDACTED] to see what's going on. And I was going to come over there on my lunch
187 and cut his hair. And um, shave him. Thank you so much. All right. Bye-bye.
188 Sorry.

189
190 Q: Just let the tape reflect that [REDACTED] had to take a uh, emergency phone call
191 and that's what she was doing. All right, so after you talked to them for a
192 while um, what happened after that?

193
194 A: Well, after I first arrived and then kind of listened to them, to find out what
195 they thought was going on, I went over to- I guess I'll just call it the
196 Command Center.

197
198 Q: Uh-hmm. The Van?

199
200 A: The Van.

201
202 Q: The Command Post.

203
204 A: The Command Post. And just kind of talked to them about- I kind of got up to
205 speed about what was actually going on. And then I asked and I don't
206 remember who- I really liked the guy. I think he was from Pelican Bay.
207 Excuse me- or maybe he wasn't from Pelican Bay. That- that was Monday.
208 See, I'm all- there's just been so much going on...

209
210 Q: A lot going on.

211
212 A: I'm kind of garbled a little bit with who did what. That was Monday. But,
213 there was somebody there um, Sunday night- it was so dark. Well, first off, I
214 asked (Willy) what was going on because he's the Tribal Chief.

215
216 Q: Uh-huh.

217
218 A: And um, I wanted to talk with him. I figured he would know what was going
219 on. But I think what I did was tried to get- I asked somebody and I don't
220 remember who- what may I tell the family. You know, the family wants to
221 know what's going on- what would you like me to say? And so um, that's
222 what I did. I took that information which was very benign you know,
223 everything- nothing really has changed, it's dark, they don't have any

224 intention on going in or um, firing on him. They would like a peaceful sol-
225 you know...

226
227 Q: A peaceful resolution.

228
229 A: A peaceful resolution. Uh, it's dark, it's really unsafe. They don't want to let
230 anybody in because he has already fired on people. Um, they're doing
231 everything humanly possible to try to get this to resolve itself.

232
233 Q: So, you're telling the family this?

234
235 A: This is- I was allowed- this is what I was told by somebody I could...

236
237 Q: And you can't remember- did (Willy) tell you that or...

238
239 A: No, it was maybe uh, a Sheriff. You know, they said basically, nothing really
240 has been going on, everything is pretty much the same. They have the place
241 surrounded. They have no intention of shooting in there or storming. It's dark.
242 They're hoping he's calmed down. Um, you know, he's staying inside, no
243 more shots of fire. Yes, he's still- you know, did he blow one. Sorry, he has
244 really bad gas. Legendary. We're talking about the bull dog. So... Sorry.

245
246 Q: So, someone told you that just tell them that they weren't- that there was
247 nothing going to be- any kind of shooting, they're not going to do anything
248 into the night. Uh...

249
250 A: No, I wouldn't say it that way. I would say that what they said- what the
251 officers kept telling me is you know, the family was very concerned that the
252 officer's were going to shoot him. And so the message to the family was very
253 consistent throughout the two days- if he comes out peacefully- if he comes
254 out without weapons- you know, if he comes out unarmed and wants to just
255 kind of- they're won't be- I mean there wouldn't be any problems. The family
256 was very concerned that it was- they kept saying "going to end the [REDACTED]
257 [REDACTED] and um, so basically, they were looking for reassurance that the
258 officers weren't going to go in there. Um, I ba-I just gave the family- I just
259 reassured the family that the team that was there- one of the things that the
260 family wanted to know was why are there so many officers. Why? This is
261 over kilter. So many people here. And so the response to that was there are
262 teams of people so that nobody gets tired, everybody's working together to try
263 to insure that there's a peaceful solution. That's-that's the entire- that pretty
264 much sums up what I would tell the family on the two days. Where it's just
265 kind of reassure them...

266
267 Q: Okay. And did you do that?
268

269 A: That's pretty much it. There wasn't really- the only other thing I really did
270 was on Monday- I mean that was pretty much it with the family. I would just
271 get the information and take it back. I made sure that um... you know what
272 you guys? I've got to have- I'm going to have to shut this door and let you
273 guys...

274
275 Male: Come on [REDACTED]

276
277 A: I know he doesn't like the door being shut.

278
279 Male: Come on.

280
281 Q: Thank you.

282
283 A: I'm sorry. It's sorta busy.

284
285 Q: That's all right.

286
287 A: With all our folks with groups- I'm sorry.

288
289 Q: So, you were saying on Monday, one other thing you did was?

290
291 A: [REDACTED] from Pelican Bay came to me um- the only other thing I did both days
292 on Sunday and Monday is talked with the family and said um, what things can
293 be said that- what do you think should be said to [REDACTED] that could get him to
294 come out peacefully? And so...

295
296 Q: So, [REDACTED] asked you that?

297
298 A: She asked me to do that on Monday.

299
300 Q: Monday. And was she a hostage negotiator?

301
302 A: Yes, from Pelican Bay.

303
304 Q: From Pelican Bay.

305
306 A: And on Sunday, we just did it because that's what we do. You know, that's
307 what we're looking for as [REDACTED] what can we do? You know, what
308 things should be said? And so I got some of the information, I went to the
309 family, and took paper and pen and we wrote down things mom wanted him
310 told. And the family suggested we said to him.

311
312 Q: And what were those things?

313

314 A: The mom said, tell him I love him, tell him to come out. Um, tell him
315 nobody's going to hurt him. Tell him nobody's going to shoot him. Tell him
316 we'll help him, tell him the family's here. Tell him this family member or that
317 family member is concerned. Tell him we're praying. He- the dog does not
318 like being separated from me. He's like my prom date or something. He's
319 picky. He has to have his good eye on me.
320

321 Q: Okay um, okay. So, that was pretty much your whole role?
322

323 A: On Sunday. Yeah.
324

325 Q: That was Sunday you gave them that information?
326

327 A: That was the Sunday stuff that the family said. And on Monday the only
328 differences, the only additional things that you haven't already discussed is on
329 Monday when they came to me and I suggested she talk to the- she talk to
330 some of the tribal members because they're Native American. And culturally
331 it's very different up in the valley than it is down here. And it's very important
332 to respect the cultural things.
333

334 Q: And you told [REDACTED] this?
335

336 A: I told [REDACTED] this. And linked her up with a couple of guys from the Fire
337 Department, the Hoopa Valley Tribal Fire Department.
338

339 Q: Uh-hmm.
340

341 A: And um, asked them to give her some suggestions of things like the White
342 Bear Skin dance that's coming up in September. Um, so I asked that they give
343 her information such as that and so they talked to her about feathers and
344 family root and family prayers and that he agreed simply committed his life to
345 God. And they gave her a lot of really good things. She wrote them down.
346 And said that if they had an opportunity to interact with him, they would. And
347 then the other thing I did was the family was (unintelligible) I asked if they
348 could have some of the food- if I could have some of the food that had been
349 brought up for the team to feed the family with because they were hungry.
350

351 Q: So, did you feed the family?
352

353 A: I gave them the food that I had brought up and I was given sandwiches. And
354 took them sandwiches and water.
355

356 Q: So, how long were you up there?
357

358 A: I was up there until about three in the morning on uh, the first day we went up,
359 Sunday. From whatever- dinner to three.
360
361 Q: Okay.
362
363 A: And turned around and came here. And then when they asked that we came
364 back up. I talked to [REDACTED] at maybe eight.
365
366 Q: In the morning?
367
368 A: In the morning. On Monday. And at 7:30- 8 o'clock called [REDACTED] said I had
369 just talked with [REDACTED] who asked that we come back up. I asked those to
370 talk on the phone- I told [REDACTED] I need to talk to my supervisor. I don't get to
371 make decisions but I do follow directions really well. And um, so [REDACTED] and I
372 then talked and I went and picked her up and we drove up together again and
373 um, stayed up there. We left there about four on Monday.
374
375 Q: So, eight to four on Monday?
376
377 A: Yeah.
378
379 Q: Okay. Um, anything else you want to add that might be pertinent? How do
380 you think it was handled?
381
382 A: I thought the officers- my heart breaks for them. To be really honest. And my
383 heart breaks for the mom. And I stood there with the mom. These are my
384 opinions. You're asking me to give my opinion?
385
386 Q: Yeah.
387
388 A: Okay. It's different. This isn't what was said or done.
389
390 Q: Uh-hmm.
391
392 A: I think that I've been involved in three of these now what this year. And um,
393 this was the hardest, most awful one. Um, standing there with mom as mom
394 watched the fire burning and killing her son is one of the hardest things I've
395 ever had to do. She- the whole family, they're Native American and if you
396 don't know Indians, then you don't get it. But mom [REDACTED] she was
397 there the entire time. She left maybe 15 minutes to check on another child to
398 make sure another child was taken care of and contact family. The whole time
399 mom had dignity and respect. Um, all of the officers were- in my opinion,
400 seemed very committed to trying to get a peaceful solution. They were all
401 willing to stay another day. Um, mom thinks that it was the- I've talked to
402 mom since. Mom thinks it's the tear gas. I'm sure you've seen the news and

403 read the papers and talked to mom, but mom feels it was the tear gas that um,
404 that you know, that set the fire. Um, the officers feel that something else.
405 Personally, I don't know. I was not there. I really was not there. I can't- I can't
406 make a judgment...

407
408 Q: Uh-hmm.

409
410 A: About any of that because I do not know. What I do know is that um, I think it
411 was really hard for everybody that they couldn't go in and do something.

412
413 Q: It's a hard situation.

414
415 A: I think the mom. You know, I think it had to impact her and [REDACTED] the worst.
416 I'm very concerned about [REDACTED] Um, but I think it was so hard on the
417 officers. I mean, they were just- they were- I really liked that Pelican Bay
418 crew. That one um, officer that I was talking about that I really, really liked.
419 When we gave him all the stuff and we actually- I had a piece of root in my
420 truck that had been blessed, that had been given to me and um, and they had
421 some feathers. So, we put together a little manila envelope thing and small put
422 in, or Cookie put in pictures of the kids. They put in necklaces he wanted. And
3 with all the information everybody up there had some names. Um, one person
424 that was there for him, one family member that was there for him was named
425 [REDACTED] and [REDACTED] s very fond of her and when she had kids, he nicknamed
426 them Cookie crumbs. And so um, you know, the family was trying to pull all
427 this together. And you know, it wasn't only the Pelican Bay. It was the others
428 as well, but the negotiating team- when they looked at all this, said we can
429 talk him out. If we can just figure out how to have communication with him.
430 With all of this stuff, we can talk him out of here. I mean, this is good stuff.
431 We can get him out. We can have- up to the bitter end thought that they could
432 do that. And that was the feel Sunday night. There was one officer that made
433 me really mad. I have no clue who he is. Um, I don't know who he is. I
434 wouldn't be able to recognize him in a line up of two. I felt that he was very,
435 very rude. He was this far away from the car where the family was and one of
436 other officers was looking down on the valley and said, oh, my god, that's
437 beautiful, just look how beautiful that is. And the rude officer said, yeah, I got
438 to see it in the daytime with all the tweakers, and the burned out cars and
439 scummy buildings. I-I just felt it was uncalled for.

440
441 Q: Yeah.

442
443 A: I just felt it was a very rude. I walked away. I mean, I just- I wanted to tell him
444 he was rude and of course I can't but that's the only negative uh, incident that
445 I saw. And-and I couldn't identify the person. And I don't want to know who
446 he is. So um.

447

448 Q: That's too bad. It is a beautiful valley.

449
450 A: It is.

451
452 Q: Okay. Anything else you can think to add? Okay, so we will conclude this
453 interview. It is 10:36 and it will conclude.

454
455
456 This transcript has been reviewed with the audio recording submitted and it is an accurate
457 transcription.
458 Signed _____

INTERVIEW WITH [REDACTED] [REDACTED]

Q=Chief (Michael Hislip)

A=[REDACTED] [REDACTED]

1
2
3
4
5
6
7
8
9
10
11
12
13
14
15
16
17
18
19
20
1
22
23
24
25
26
27
28
29
30
31
32
33
34
35
36
37
38
39
40
41
42
43
44

Q: Uh, this is Chief (Mike Hislip) from Humboldt County District Attorney's Office. I'm here at the Hoopa Police Department interviewing [REDACTED]. He was the dispatcher on duty and took the initial call on the [REDACTED] case that the uh, Sheriff's Department is investigating. ([REDACTED] or I'm sorry, [REDACTED] why don't you go ahead and tell me how you first started- how the call first started out.

A: Okay. His mother [REDACTED] [REDACTED] - I spoke to her that morning. She stated that the well being of [REDACTED] she didn't think he was doing okay. She hadn't seen him in a week. He wouldn't talk to her, cause I guess they were having a conflict, she didn't know, but she said that he was talking to imaginary cats and people a week before she called and...

Q: That was a week before she...

A: Yeah.

Q: Called you?

A: The day I talked to her- a week before that he was talking to imaginary people, imaginary cats and so she didn't think he was doing okay. She didn't really know where he was at. Possibly at a neighbor's house. She didn't know where at. So, I sent out an officer, Officer [REDACTED] to go- to do a welfare check. We attempted to locate him. We checked some residences.

Q: You checked a couple of places where he hung out?

A: Yeah, just the area. Checked the [REDACTED] residence out- I don't know the last name.

Q: Okay.

45 A: Wasn't there, so we couldn't really find him. We checked for about 20
46 minutes maybe shorter or longer and then we just took an item for a GOA,
47 gone on arrival, UTL, unable to locate and then later that day I got a call from
48 [REDACTED] stating that [REDACTED] was in her house. Said that he wanted to take a
49 rest, he was tired. Um, he was on the couch falling asleep.

50
51 Q: Now, [REDACTED], is that...

52
53 A: [REDACTED]). This is the residence. [REDACTED]) residence.

54
55 Q: Is that on Bloody Creek Road?

56
57 A: Bald Hill.

58
59 Q: Okay.

60
61 A: Bald Hill. That's where we're at.

62
63 Q: Oh, so was that- is that the house where the incident took place?

64
65 A: Yeah, she called said he was in her house. She was outside.

66
67 Q: What time do you think that was? And we'll get your dispatch logs later.

68
69 A: Uh, bout a half hour before 1:54, she called in the evening. So about...

70
71 Q: So, about 1:20?

72
73 A: About 1:20, she called and said, he was in the house, she didn't know if he
74 was okay or not. She wanted...

75
76 Q: One twenty in the afternoon?

77
78 A: Yeah.

79
80 Q: Okay. All right.

81
82 A: Stated that she just wanted somebody to just come check him out.

83
84 Q: And she said he just needed a rest?

85
86 A: Yeah, she said he was tired. He looked like he was tired, he went on the
87 couch, came into the house, sat on the couch, said he wanted to take a rest,
88 was laying down. She was outside with her 9 year old boy, said not to send up

89 any cops because her 9 year old son does not like cops. And if he- if [REDACTED]
90 [REDACTED] hears sirens he'll run.
91
92 Q: So, is [REDACTED] husband or boyfriend [REDACTED]?
93
94 A: She didn't state that he was in the house or anything.
95
96 Q: Okay, but do you know [REDACTED] personally?
97
98 A: No, I don't know her personally.
99
100 Q: Okay. All right, go ahead.
101
102 A: She said, [REDACTED] was in the house, wanted to rest, she was outside, not to send
103 up any cops with sirens cause it will scare [REDACTED] and he will run. That to send
104 up an ambulance if possible just to check him out. I said well- I asked her if
105 anything medical was wrong with him and she said no, he just seemed tired
106 and wanted to take a rest so all I could do was send up an officer to do a
107 welfare check. It wasn't a Code 3 call, nothing was going on she stated. So,
108 later that evening, I- at that time I told [REDACTED] that I'd send up an officer,
9 Officer [REDACTED] as soon as he got in town. Officer [REDACTED] was
110 transporting a prisoner so at 1:54 on the dispatch log [REDACTED] mother,
111 [REDACTED] or [REDACTED] mother, reported that [REDACTED] had called her and stated
112 that [REDACTED] was going to [REDACTED]. She didn't- [REDACTED] didn't really
113 have really good directions on where [REDACTED] lived so I had to call [REDACTED]
114 back which [REDACTED] gave the cell phone number to [REDACTED]. So, I called her
115 back. I got better directions. Then I called the S.O., told them what was going
116 on. [REDACTED] said he didn't have any weapons. He had a trench coat on, he
117 was laying down, seemed fine, but I don't know where [REDACTED] got off
118 saying he was going to [REDACTED] because she said [REDACTED] did. So,
119 [REDACTED] like yeah, send up somebody.
120
121 Q: Okay.
122
123 A: So, I sent up the officers. Nothing was wrong with him. So, I did the welfare
124 check, called the S.O., Humboldt County Sheriff's, told them what was going
125 on. He was possibly [REDACTED] and to do a welfare check. And that our officer
126 was out on a transporting a prisoner. And then from there S.O. dispatched and
127 got their officers. And then throughout the day at 1532, S.O. called me and
128 said that dispatch my officers because [REDACTED] was pointing a gun at the- at the
129 Humboldt County officers- Sheriff's. So, I dispatched 2501, which is (Will
130 Hausser), 2503 (Ed Guyer). I attempted to call 2506. 2506- left numerous
31 messages (Dan Norton) and contacted 2504 (Matt Splino) got a hold of him.
32 He came in route from Eureka. All of them got up there at- let's see. They
133 arrived ten minutes later. About- let's see. Yeah, I'm pretty sure they got there

134 about ten minutes later. They went en route Code 3 from their residences, off
135 duty. And then 1555, 01, the Chief requested Medical to standby, so I
136 dispatched the ambulance at 1555. Do you need me to go through this whole
137 thing?
138

139 Q: No. You don't need to do that. As long as I get a copy of that.
140

141 A: Yeah. And then...

142
143 Q: So, basically, just a recap- earlier in the day, if you could remember what
144 time, [REDACTED] [REDACTED] called and I said I haven't seen my son in a week.
145

146 A: Yeah.

147
148 Q: Last time I did see him he was talking about talking to imaginary cats and she
149 was worried about him?
150

151 A: Yeah.

152
153 Q: You dispatch one of your officers and they check several locations in the area
154 where he hangs out, couldn't find him so they clear DOA.

155
156 A: Yeah.

157
158 Q: And then at uh...

159
160 A: 1320.

161
162 Q: And then at 1520.

163
164 A: No, at 1320.

165
166 Q: Oh, at 1320, uh, then [REDACTED] who I'm assuming lives with [REDACTED] where the
167 incident took place which is basically on- is it called Bloody Creek Road?
168

169 A: No, Bald Hill. Bald Hill Road.

170
171 Q: Well, actually, it's off that road where the incident is. It's that road. What's
172 that road? Is it called Bloody Creek or Bloody Valley?
173

174 A: Bloody Camp?

175
176 Q: Bloody Camp Road. It's off of Chief (Hausler)'s [REDACTED]
177

178 A: [REDACTED]

179
180 Q: Yeah. Off the dirt road there. So, it's Bloody Camp Road.
181
182 A: Umm.
183
184 Q: So, anyhow, she calls at 1320 and says that ([REDACTED] s at the house, wants to lay
185 down, needed a rest. Did she state anything that he was acting weird or
186 anything?
187
188 A: She didn't say he was acting weird. She just wanted him to be checked out
189 because he looked like- she stated he was tired.
190
191 Q: Okay.
192
193 A: Really didn't have a justification as to why.
194
195 Q: Did you- did you dispatch anybody up at that time?
196
197 A: No, I told her that our officer was transporting a prisoner and my Chief
198 advised me not to dispatch unless we had a Code 3 call to officers if they're
199 transporting.
200
201 Q: Okay. Fair enough. And then at um, at 1354 hours ([REDACTED] calls you again
202 and says that ([REDACTED] is up at [REDACTED] house and is going to [REDACTED] ?
203
204 A: Yeah.
205
206 Q: But she didn't relay why?
207
208 A: She didn't really say why.
209
210 Q: Okay.
211
212 A: She said that [REDACTED] called her and told her that.
213
214 Q: Okay.
215
216 A: And actually, when I contacted ([REDACTED]) again, she said she was in the bushes
217 with her son. I was all, why are you in the bushes? Why don't you want him
218 seeing you? I don't want him seeing me talking to you guys cause he'll get
219 scared and run.
220
221 Q: Okay.
222
223 A: So, that's when I was initially like hey...

224
225 Q: Something's up.
226
227 A: Yeah.
228
229 Q: Okay.
230
231 A: So, I didn't want to send out an ambulance because they won't go in anyway
232 unless an officer is present.
233
234 Q: Okay.
235
236 A: So, I sent up the officer's just to do a welfare check.
237
238 Q: Okay. All right. So, then at that time, you didn't have anybody available so
239 you called the S.O. Dispatch.
240
241 A: Yeah.
242
243 Q: And they dispatched one of their units.
244
245 A: From (Witchepeg).
246
247 Q: From (Witchepeg).
248
249 A: And then they contacted my officer also, cause I don't have radio frequency
250 that far away. They contacted him over their radio, called me and said that
251 they had dispatched him and to contact my officers to go up there.
252
253 Q: And that was at 1532? That was when they were asking for a back?
254
255 A: Yeah. Tribal Police. He's on, I can give you his Voice mail. Hold on.
256
257 Q: So, okay. So, that's when they were asking for a back. So, the S.O. was
258 already there?
259
260 A: Yeah. I- I dispatched S.O. at 15- 1402 to tell them what was going on. In the
261 mean while I was taking care of trying to get information cause I really
262 couldn't send them up there on something blind.
263
264 Q: Right.
265
266 A: I received the call at 1354 and dispatched them at 1402, advised them that my
267 officer was transporting and if they could send up a unit too. And then 1532,

268 they advised me that [REDACTED] is in residence pointing a gun at them and
269 requesting back up.

270
271 Q: Okay.

272
273 A: And at that time, they had dispatched my officer 2505 who was transporting.

274
275 Q: Okay. Uh, any other things? Do you know [REDACTED] at all?

276
277 A: I don't know him, no.

278
279 Q: Never met him?

280
281 A: No.

282
283 Q: Is there anything else you can add that might shed some light on this incident
284 that you can think of?

285
286 A: And then after that, they took the call. After the officers got up there. I got the
287 ambulance, I just listened and made sure everything was going okay. Kept in
288 contact with S.O., just to keep each other updated. Told them when the
289 ambulance was on scene and everything.

290
291 Q: Okay. Well, then we'll go ahead and end the taped statement. The time is uh,
292 1051.

293
294
295 This transcript has been reviewed with the audio recording submitted and it is an accurate
296 transcription.
297 Signed _____

1
2
3
4
5
6
7
8
9
10
11
12
13
14
15
16
17
18
19
20
21
22
23
24
25
26
27
28
29
30
31
32
33
34
35
36
37
38
39
40
41
42
43
44

INTERVIEW WITH [REDACTED]

Q=Chief (Michael Hislip)

A=[REDACTED]

Q: Okay, today's date is June 7th. It is uh, 1305hrs. I'm at [REDACTED] Street interviewing [REDACTED] in regards to the incident that uh, occurred up in Hoopa. My name is Chief (Michael Hislip) from the Humboldt County District Attorney's Office. [REDACTED] okay, let's go ahead and tell me how you received the call to assist. Well, before we do that, what is your job title?

A: I'm a Supervising Clinician for the [REDACTED] branch.

Q: Okay. So, how did you get the uh, call to respond up to Hoopa?

A: Um, according to protocol, the Sheriff uh, Lieutenant (Knight) called our crisis line and informed the person on crisis that he needed some assistance from our CIT team. I supervise that team and I'm on call 24/7.

Q: CIT?

A: CIT. Crisis Intervention Team.

Q: Okay.

A: The (Pez) Unit staff called me at home on my cell, let me know that the Lieutenant had asked for me. I called him back and he told me that they could use our assistance up in Hoopa and gave me direction. Um, and I called my case manager that works with me on that team, [REDACTED]

Q: Uh-hmm.

A: And we met and went on up to Hoopa.

Q: Okay, what time was that about? What time did you receive the call?

A: Call, probably about a quarter to 3:00- maybe- between 2:45 and 3 o'clock.

- 45 Q: Okay. And then when did you pick up [REDACTED] [REDACTED] and uh, drive up to
46 Hoopa?
47
- 48 A: Probably an hour later I picked up [REDACTED] and we headed up the hill.
49
- 50 Q: So, you're saying four...
51
- 52 A: Four, four thirty. Yeah.
53
- 54 Q: Okay, did you discuss a game plan?
55
- 56 A: Um, basically [REDACTED] and I agreed we would drive up to the site and um, see
57 what the officers could use us for. How we could be helpful in the situation.
58
- 59 Q: Okay, at that point did you give- did you assign her to something and did you-
60 did you do something?
61
- 62 A: Not until- no, not until we got there.
63
- 64 Q: Okay, so- but when you got there, what did you do? What were your
5 assignments? Eventually?
66
- 67 A: Um, we were briefed by Lieutenant (Knight) about what had occurred um, up
68 until that point up there on the mountain and what was going on in the
69 peripheral- where the family members were. They wanted us to get some
70 information for them about um, what type of [REDACTED] the client was on,
71 when he had been last treated, that kind of information. And that's pretty
72 standard information that we do provide. Law enforcement in a crisis
73 situation.
74
- 75 Q: So, did Mrs. [REDACTED] talk to the family?
76
- 77 A: So, Mrs. [REDACTED] eventually- at first we just stayed together and reviewed what
78 information [REDACTED] had about the [REDACTED] provided that to the um,
79 officers. They gave us information that they had gotten so far from the family
80 and then um, [REDACTED] did go talk to the family. [REDACTED] is pretty well known
81 up in the valley and she is connected with many people. If they don't know
82 her well, they know who she is. And they feel- they feel very comfortable
83 with her. So she was the ideal person to- to be the link with the family
84 members. And so she did talk to them. And we got some more information.
85 She got some more information about just personal things about the [REDACTED]
86 that might be useful in negotiation.
37
- 88 Q: And what were those- do you remember what kind of information?
89

90 A: Um, that he is particularly fond of his niece. That um, you know- just
91 relationship um, things that were important to him, that might be useful to us
92 in appealing to him to be safe and come out.
93

94 Q: Okay. What happened after that?
95

96 A: Um, we- you know, of course we stayed either in the command vehicle or
97 further back so we were not able to see actually the house. It was a safety
98 issue. They were really being very protective of everybody and um, law
99 enforcement was. Um, at that time, there wasn't any activity going on in the
100 house. There was no exchange. They informed us of the attempts that the
101 negotiators had made through the bull horn. And that there wasn't- aside from
102 the initial um, him coming out, there wasn't any real negotiation. Um, and so
103 we stood around. We kind of strategized. We talked about more information. I
104 called back to um, [REDACTED] and asked to get his discharge plan. Um, so
105 we knew exactly what [REDACTED] should have been on board if any and...
106

107 Q: What [REDACTED] was he supposed to have?
108

109 A: He was- he was ordered um, [REDACTED]
[REDACTED] and there was a doctor's visit scheduled for him on either Monday or
110 Tuesday.
111

112
113 Q: [REDACTED]
114

115 A: [REDACTED] And that information I got over the phone
116 from [REDACTED]
117

118 Q: Did they relay any other information that he [REDACTED]
119 [REDACTED]
120 [REDACTED] ?
121

122 A: [REDACTED]
123 [REDACTED]
124

125 Q: Okay.
126

127 A: So, when you think of a hospital, you think of the ER.
128

129 Q: Uh-hmm.
130

131 A: And then actual hospital-hospital admission.
132

133 Q: Okay.
134

135 A: Separate things. [REDACTED]
136
137 Q: Okay.
138
139 A: And from there I believe, he went into- he went to the jail.
140
141 Q: [REDACTED]
142
143 A: That's what I heard. I wasn't on my Unit, so I didn't actually experience it.
144 But that's what I heard.
145
146 Q: Okay.
147
148 A: So, he was in the jail until the 30th. [REDACTED] [REDACTED]
149 [REDACTED] [REDACTED]
150 [REDACTED]
151
152 Q: [REDACTED]
153
154 A: Uh-hmm.
5
156 Q: [REDACTED]
157
158 A: Uh-hmm.
159
160 Q: Okay um, did they relay to you uh, any that he was violent or anything?
161
162 A: Uh, they didn't really. They didn't give me any details. Uh, you know- we're
163 up there trying to get through cell phone crackles and um, I-I haven't seen the
164 [REDACTED] so I didn't have that information.
165
166 Q: Okay. All right. So, after you got that information, what happened?
167
168 A: Um, basically we stayed around. We talked about possibilities of services, of-
169 you know, we talked about of possibilities of negotiation. We don't negotiate
170 unless we're directly asked to. The negotiators are great. They don't really
171 need us to. Um, so primarily we stayed around and talked um, about what was
172 happening and what options there were. And gave parents a little bit of
173 information- very little. And then [REDACTED] uh, mostly did that. And then
174 about 12:30 um, the officer that was in command of-of the SWAT team or the
175 Negotiation team said we're just going to shut down for the night. Basically,
176 he said that we're not going to do anything. We're not going to engage him,
77 we're not going to move forward, we're not doing anything until daylight.
178 And then we'll think about what we can do when there's some light. And I
179 understood that he was going to pick up the shift like at two or two thirty.

180
181 Q: Uh-hmm.
182
183 A: And so they said, you guys can go down the hill and we'll call you if we need
184 you. And so um, we went down, I got home about a quarter to three.
185
186 Q: So, you left the scene at about what time do you think? Twelve thirty at night?
187
188 A: It was about twelve thirty, quarter to one. And I- it takes me a couple hours to
189 get home. By the time I drop [REDACTED] off and down to [REDACTED]
190
191 Q: And when did you arrive back on scene?
192
193 A: I think we got back on the scene about 11:30 in the morning. We pretty much
194 turned around. I got- I started getting phone calls from my administration in
195 the morning cause they wanted to know what was going on and then um, got a
196 call from [REDACTED] from Pelican Bay, I think around 9:30- 9 o'clock, maybe.
197 And then [REDACTED] met me here in Eureka and we went on up.
198
199 Q: Okay so um, just go ahead and give me a synopsis of what- from 11:30 when
200 you arrived on Monday...
201
202 A: Uh-hmm.
203
204 Q: What did you do?
205
206 A: Um, we met again with the family. [REDACTED] especially met with the family.
207 One of the concerns and-and of course we met the new team that was on. This
208 was Pelican Bay at the time. And um, and they updated that they had
209 introduced tear gas or gas canister into the house. I believe they had done it
210 twice. They did once, waited an hour, did another one. Um, again not really
211 any negotiation or verbal exchange except for around 5 o'clock, [REDACTED] yelled
212 something at them. Um, but again, I wasn't there.
213
214 Q: Five o'clock...
215
216 A: In the morning.
217
218 Q: Monday morning, okay. So, right- right. So, let's just stick with 11:30 when
219 you arrived.
220
221 A: Okay, so...
222
223 Q: You met with the family...
224

225 A: We met with the family. One of the concerns was the brother [REDACTED] really
226 was anxious and appeared that he really wanted to go talk to his brother. And
227 of course, mother was saying, she would like to talk to him. Um, [REDACTED] did
228 a great job explaining that if they got near him, it would create a hostage
229 situation and-and everybody would be at greater risk. And the family got that
230 very well.

231
232 Q: Okay.

233
234 A: And then they didn't push for, you know, going into the house or talking to
235 him anymore. And at- and they understood. I think we were able to explain,
236 officers were able to explain um, that- you know, getting close enough to
237 really have a conversation would put everybody at risk. We couldn't do it.
238 Um, their-their big handicap was there was no phone in that house.

239
240 Q: Uh-hmm.

241
242 A: So, we really couldn't contact him. Um, so we stayed in contact with the
243 family. There was some community members that came by. Officers must
244 have handled that. Um, they introduced tear gas again and I can't remember
5 exactly what time but it was fairly soon after we got there. Maybe within an
246 hour. Um, and then we just waited, got more information from the family
247 about his favorite little nieces and his favorite nephew and his nicknames for
248 them. Anything that we could think of that would, you know, help him
249 connect. If we could ever get to talk to him.

250
251 Q: Uh-hmm.

252
253 A: And then, I guess, about 2:30 or so, we heard that there was fire, there was
254 smoke coming out of the house.

255
256 Q: Okay.

257
258 A: And then a lot of what we were doing was trying to do was just be supportive
259 of the family. At that point, there wasn't really anything we could do. Um, so
260 we stayed until um, the- we were told that the house was engulfed in flame.
261 And then we stayed- they moved the fire trucks forward.

262
263 Q: Uh-hmm.

264
265 A: Toward the house and we stayed some more. And then we noticed.

266
57 Q: So, at this time, you're trying to comfort the family while the fire was going
268 on?

269

270 A: Yeah.
271
272 Q: Okay.
273
274 A: Yeah. And then after a while um, the SWAT team came down off the hill.
275 And- and then it was kind of understood that it was over. And the arson team
276 came up and you guys were up there by then.
277
278 Q: Uh-hmm.
279
280 A: And so um, we decided there was really nothing more we could do and you
281 know, but get in the way, so we decided to leave.
282
283 Q: What time did you leave?
284
285 A: Uh, what time was it? Must have been about 4:30. Something like that. Cause
286 we got- I got home at 6:30. So, that would have been just about right. So we...
287
288 Q: What comments were the family making now? Did they realize the fire
289 probably had uh, caused [REDACTED] to die?
290
291 A: They were very sad. Um, when they saw the fire, the mom was saying this just
292 doesn't look good, this isn't good. And a little bit of why aren't the fire trucks
293 going in- in the very beginning when the fires first started. It was why don't
294 the fire trucks go in? And again, it was there's so much ammunition, we don't
295 know if he'll shoot at them. That kind of thing. And they got it. They weren't-
296 they weren't- I didn't get a sense that they were angry, they were just so
297 scared and-and anxious.
298
299 Q: Uh-hmm.
300
301 A: And upset. Um, and then um, they did call- we do know that they had talked
302 to media. Family members had talked to media. And that was towards the end.
303 And then um, so then when we were leaving we stopped to say we're on our
304 way out, give us a call if you need anything and gave cards to the officers and
305 did the same thing with the family. We stopped by where they were sitting
306 and gave them our cards. And um, said please call us and we went home. And
307 just before the fire started um, people were starting- the officers were noticing
308 they were running out of food and um, they were figuring out who was going
309 to run to the store and get more food and we always carry um, the CIT team
310 always carries a, standoff bag that has vouchers and flashlights and supplies
311 and stuff.
312
313 Q: Very good. Awesome. Um, including motel vouchers, and food vouchers and
314 stuff. So we gave them our food vouchers and said go get you know, plenty of

315 food for everybody. They were prepared to stay. I mean, there were
316 comments, we might be here all week- yeah, we might. They- it was that- that
317 was the plan. It was like- and [REDACTED] and I looked at each other- before the
318 fire and before we realized it wasn't going to go on, um, thinking, let's see,
319 she's got her pickup truck, can we sleep in there and just not drive down
320 again. But I mean- everyone I think was prepared. They were looking at the
321 Sheriff's Van, noticing okay, there's a couple of bunks there people could lie
322 down on, there's a couple of bunks in the command center. People could get
323 rest. Um, so that was- we were going to be here for the duration. That was the
324 the way I got the experience. Or the expectation.

325
326 Q: Okay, let's go back to Sunday when you uh, arrived. At any point, did you
327 hear any gun shots?

328
329 A: I didn't. No. Um, no I didn't hear any gun shots.

330
331 Q: Do you think that the um, the Sheriff's Department and the SWAT team, do
332 you think they were trying to do everything they can to get this thing resolved
333 peacefully?

334
335 A: I think they were doing anything and everything they could. And that's
336 definitely one of the reasons they call us. This is my third standoff. And um,
337 I'm always impressed with how hard they work to have a peaceful resolution.
338 And keep everybody safe. You know, they're very conscious of their safety
339 and they're very conscious of the safety of the person who is barricaded. They
340 didn't- they really wanted him out safely. You know, we really talked about
341 when he comes out, obviously, he's going to go to the jail, alert our [REDACTED]
342 [REDACTED] immediately so they'll be ready to be there, so he gets [REDACTED] right
343 away and you know, that's just the kind of thing we were talking about. It was
344 future planning.

345
346 Q: Okay. Good. Um, anything else?

347
348 A: I think all these teams and I worked with all three different departments that
349 have SWAT teams and negotiating teams. They're amazingly skilled
350 negotiators. Um, the only time they need us to do a piece of that is when they
351 don't have a negotiator. When I was Rio Del they didn't have one, so I
352 jumped in a little more than I normally would, but those guys are good.

353
354 Q: Yeah, they are.

355
356 A: I mean, they're really sensitive and they really care and they really want them
357 out. They want them safe.

358
359 Q: Okay. Anything else you can think of that might shed some light on...

360
361 A: Um...

362
363 Q: The incident?

364
365 A: And I understand that there's such a really good drill and protocol with
366 different teams etcetera, but and-and this is something maybe for just future
367 thinking is how to include- especially on the reservation- the tribal police.
368 And- and have some kind of interactive training so that there's an expectation
369 on the reservations that the tribal police are more active.

370
371 Q: You know (Willy Oso) was there the whole time?

372
373 A: Yes, he was.

374
375 Q: And he was helping out quite a bit.

376
377 A: Yeah.

378
379 Q: Um, okay.

380
381 A: I-I just think it's real important. It's a different world.

382
383 Q: Uh-hmm.

384
385 A: It's- it's different than anything else I've experienced in the rest of the county
386 than up there.

387
388 Q: Okay. Very good. The time is 1323 and we will end the interview.

389
390

391 This transcript has been reviewed with the audio recording submitted and it is an accurate
392 transcription.
393 Signed _____

OFFICE OF THE
DISTRICT ATTORNEY
COUNTY OF HUMBOLDT

PAUL V. GALLEGOS
District Attorney



WES KEAT
Assistant District Attorney

JEANNIE Y. DUNCAN
Legal Business Manager

MICHAEL R. HISLOP
Chief Investigator

Attempted Murder of Peace Officer Incident
Hoopa, California

H.C.S.O. Case # 200703162

Supplemental Report

Written by D.A. Investigator Steve Dunn

CRIMINAL DIVISION

825 5TH Street
Eureka CA 95501
(707) 445-7411
(707) 445-7416 Fax

VICTIM WITNESS ASSISTANCE

712 4th Street
Eureka Ca 95501
(707) 445-7417
(707) 445-7400 Fax

OFFICE OF THE
DISTRICT ATTORNEY
COUNTY OF HUMBOLDT

PAUL V. GALLEGOS
District Attorney



WES KEAT
Assistant District Attorney
JEANNIE Y. DUNCAN
Legal Business Manager
MICHAEL R. HISLOP
Chief Investigator

[REDACTED]

H.C.S.O. Case # 200703162

TABLE OF CONTENTS

* NARRATIVE	D.A.I. STEVE DUNN (26 PAGES)
* TRANSCRIPT	LT. DAVE MOREY
* TRANSCRIPT	LT. STEVE KNIGHT
* TRANSCRIPT	DEPUTY TONY GOMES
* TRANSCRIPT	DEPUTY BRIAN TAYLOR
* TRANSCRIPT	DEPUTY JAMIE BARNEY
* TRANSCRIPT	SERGEANT BRIAN QUENELL (#1)
* TRANSCRIPT	SERGEANT BRIAN QUENELL (#2)
* TRANSCRIPT	LT. GEORGE CAVINTA (COMMANDER)

CRIMINAL DIVISION

825 5TH Street
Eureka CA 95501
(707) 445-7411

VICTIM WITNESS ASSISTANCE

712 4th Street
Eureka Ca 95501
(707) 445-7417

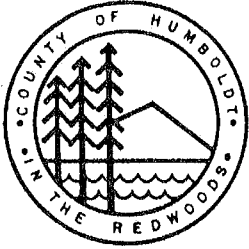

HUMBOLDT COUNTY DISTRICT ATTORNEY'S OFFICE INVESTIGATION REPORT

DATE: 6-11-07

██████████ ██████████
AGENCY CASE: HCSO # 200703162

OFFENSE: 664 / 187, attempt murder of Peace officer

WRITTEN BY: D.A. Investigator Steve Dunn

REPORT

On 6-3-07 at about 2100 hrs, Chief D.A. Investigator Mike Hislop contacted me via phone at my residence. Hislop requested I assist him with an incident that was occurring in Hoopa. Hislop advised me that the Sheriff's Department had a barricaded ██████████ in a residence. The ██████████ had already fired a weapon at Deputy's on scene. Lieutenant Cavinta requested D.A. Investigators respond and assist with interviewing witnesses who were still present. I responded to Chief Hislop's residence in Eureka and then we drove to Hoopa in his vehicle.

While at the scene, Hislop and I met with Lt. Cavinta at a command post vehicle that had been set up on a private driveway and Bloody Camp road. Cavinta briefed us on the situation, ██████████ who needed to be interviewed and identified Detective Rich Schlesiger as the Lead Investigator for the Sheriff's Office. While initially on scene, Chief Hislop or I never approached the residence where ██████████ was barricaded. We were advised that the residence had been surrounded with Deputies and a S.E.T. team. We were also advised that attempts to negotiate with ██████████ were in progress. The scene was considered an active shooter situation.

Chief Hislop completed one interview at the scene. Refer to his report for further. On 6-4-07 at about 0200 hrs, Hislop and I returned to Eureka, as there were no other interviews pending. We met later in the morning at the D.A.'s office and responded back to Hoopa to assist. While at the scene, I was assigned to assist Lead Detective Schlesiger with the investigation and any future interviews.

At about 1500 hrs, a ██████████ identified as ██████████ ██████████ approached me. ██████████ verbally identified himself to me as ██████████ father. ██████████ requested I ask the negotiators or the

1

CRIMINAL DIVISION

825 5th Street
Eureka, CA 95501
(707)445-7411
(707) 445-7416 Fax

VICTIM WITNESS ASSISTANCE

712 4th Street
Eureka, CA 95501
(707) 445-7417
(707) 445-7490 Fax

Officers at the house to see if he or any other family members could talk with [REDACTED] [REDACTED] advised me that he was with his girlfriend who lived in a home below the residence his son was in. [REDACTED] stated that from this location, he could hear negotiators ordering his son out of the residence. [REDACTED] stated what he was hearing did not sound like "negotiations" to him. [REDACTED] stated it only sounded like "orders". I advised [REDACTED] I would pass along the message. I later contacted Lt. Cavinta in the command post van and advised him of [REDACTED] [REDACTED] request.

As the day progressed, the Eureka Police S.W.A.T. team had responded to assist, along with a CDC (Pelican Bay) tactical team. Strategies were developed at the command post. This included the deployment of gas into the residence. Refer to Detective Schlesiger's report for further detail.

At about 1520 hrs, the Hoopa Fire Department engine staged on the driveway that accesses the house that [REDACTED] was in due to signs of heavy smoke coming from inside the residence. At about 1540 hrs, I walked closer to the residence with Detective Schlesiger and Chief Hislop. I saw the residence for the first time. I also saw that the residence was on fire. The Hoopa Fire Department later extinguished the fire. [REDACTED] was located in the residence, in a bathroom deceased.

Evidence Technician [REDACTED] was present at this time. Evidence collection, photographs and scene processing began. Refer to evidence Technician [REDACTED] report for further.

Death Notification to [REDACTED] Mother and Father

Some time after 1700 hrs, I advised Detective Schlesiger that I needed to remove equipment from my vehicle. My vehicle was parked near [REDACTED] [REDACTED] vehicle and family members vehicles on Bloody Camp Road just outside from where the mobile command center had been set up. I advised Detective Schlesiger that on two occasions earlier in the day, I had been stopped by [REDACTED] [REDACTED] who would inquire about his son's status. I advised Detective Schlesiger that if [REDACTED] and or [REDACTED] mother, who I had not yet met were on the road, I would advise them of the fire and the deceased body in the residence. Detective Schlesiger agreed.

As I started to leave the residence, I was advised that one of the firemen on scene was [REDACTED] [REDACTED] cousin. The Fireman was identified as [REDACTED] [REDACTED]. I approached [REDACTED] who was still working at the residence. I advised [REDACTED] that I was going to see [REDACTED] father [REDACTED] and asked if he would respond with me for notification, he agreed. I walked towards my vehicle parked on the main road and as expected, family members met me. An unknown man approached and advised me [REDACTED] mother was sitting in a vehicle wanting to hear what happened.

I approached the female, later identified as [REDACTED] mother [REDACTED]. I identified myself and advised [REDACTED] that the house had started on fire and was now extinguished, however, the house was destroyed. I also advised [REDACTED] that a deceased person was found in the residence,

but confirmation of who that person was had not been positively made. I noticed at this time that Lt. Cavinta was present on the opposite side of the vehicle, near another unknown family member and Hoopa Fireman [REDACTED] [REDACTED]. Also about this time, [REDACTED] [REDACTED] drove up the road in his truck. I approached [REDACTED] and advised him of the same information I had advised [REDACTED]

C.I.R.T. Team Activation and Meeting

On 6-5-07 at about 0800 hrs, several Officers and Deputies met at the Humboldt County Sheriff's Department Detective Bureau. At this time, the investigation and duties of CIRT Team members were discussed. I was assigned to assist Detective Schlesiger with interviewing Deputies or Officer's who fired their duty weapons during the incident. This also included any Deputy or Officer that deployed gas into the residence.

Interview with Lieutenant Dave M. Morey

On June 5, 2007 at about 1443 hrs, I met with Lt. Morey at the Sheriff's Office Mckinleyville substation. The interview was audio recorded with his knowledge and consent. Also present was HCSO Detective Rich Schlesiger.

Morey stated that Sunday, June 3rd at about 1700 hrs, he received a cell phone message and was advised that there was an incident in Hoopa and the S.E.T. team had been activated. Morey contacted the HCSO Dispatch center who later advised him of the standoff situation occurring in Hoopa. Morey stated he attempted to find some negotiators to assist with relief of Officers / negotiators currently on scene for the following morning. Morey stated that he contacted an Officer Higgerson from the Department of Corrections (CDC) at Pelican Bay State Prison. Morey stated that Higgerson has a large negotiations team and the Sheriff's Department had used their assistance in the past. Morey and Higgerson set up a time to meet the following morning at the Mckinleyville substation.

On June 4th at 0600 hrs, Higgerson arrived at the Mckinleyville station. Morey contacted HCSO dispatch and confirmed that the incident in Hoopa was still active. Officer Higgerson brought about 6 negotiators and 3-4 tactical personnel with him. The team, along with Morey then drove to Hoopa. Morey stated that they arrived at the Hoopa command post on the 4th at about 0745 hrs.

Morey stated after his arrival, he checked in with Lt. Cavinta. It was agreed that some of the Pelican Bay negotiators would be escorted to the scene and attempt negotiations. Morey stated he was not sure of the exact times, however, an accurate log would have been kept at the Command Post.

The CDC team moved "2" negotiators up to some police vehicles that were parked near the

scene. The negotiators from CDC attempted negotiations for about 45 minutes or more without success. The CDC negotiators advised Morey that they got "0" response, nor did they hear any movement in the house. Morey stated that when the CDC Negotiators returned, he and Lt. Cavinta discussed what some other options were with the situation. They believed that [REDACTED] could be asleep and or for whatever reason, not hearing the PA being used. Cavinta and Morey discussed possibilities of making more noise. Morey believed that from that point on, Pelican Bay negotiators did not respond back and assist with negotiations. Deputy Fridley started further surrender commands and gas was introduced into the residence. Morey stated that he was not part of the decision-making involving introduction of gas or tactical issues of the incident. Morey stated that he was in charge of the "negotiations" phase of the incident with CDC. Morey stated that every very phase he was involved with was all just a plea for [REDACTED] to come to a position to talk. Morey stated that CDC focused on more of a "negotiations" phase. The CDC people never worked in a "surrender" phase. Morey stated in his mind, Sergeant Fridley was working a "surrender" phase, not a "negotiations" phase.

Morey stated that his instructions when he arrived were to try to get [REDACTED] to communicate. Morey was to try to start negotiations. This would have been prior to tactical decisions that were made.

This interview was recorded via digital recorder. Refer to typed transcript of interview for exact details, as above narrative is only a summary.

Interview with Lieutenant Steve Knight

On June 5, 2007 at about 1525 hrs, I met with Lieutenant Steve Knight at the Humboldt County Sheriff's Office Animal Shelter located in McKinleyville. The interview was recorded with his knowledge and consent via digital recorder. Also present was H.C.S.O. Detective Rich Schlesiger.

Knight stated that he was the "on-call" Duty Officer for H.C.S.O. during the weekend. Knight said he received a call Sunday, June 3rd at about 1530 hrs. H.C.S.O. Dispatcher [REDACTED] advised him that there was a situation unfolding in Hoopa.

A [REDACTED] identified as [REDACTED] had brandished a rifle at Deputy Berry and another Tribal Officer while he was assisting with a welfare check detail. [REDACTED] advised that other Deputies and Sgt. Miller were en-route to assist.

Knight stated he was advised that [REDACTED] was recently released from [REDACTED] and was known to be violent. Deputy Berry and Yurok Tribal Officer Landernaux went to do welfare check on [REDACTED] and while on scene, he exited the house and pointed a rifle at them. The Deputy and Officer then called for assistance. Knight stated that he then talked with Sergeant Miller. Miller advised that there were some residents close by and due to concerns for public safety, he

recommended a S.E.T. team call out, as this was a serious situation. Additionally, Lt. Knight learned later that the person who owned the home was actually with Deputy Berry when the brandishing occurred and was "pinned" down along with the Deputies at the scene.

Lt. Knight stated that he called the Sheriff. The Sheriff was briefed and agreed to notify the S.E.T. team. Knight then called Lt. Cavinta, the team leader for the S.E.T. team and advised him about what was occurring. Knight also called Lt Morey, who was in charge of negotiators, but could not get a hold of him, so a message was left. Knight contacted Sergeant Fridley and Deputy Daniels who were both negotiators and requested they respond to the scene.

Knight stated he then responded to Hoopa to assist. While enroute, Knight overheard via radio that shots were fired. The S.E.T. team had arrived on scene and was taking up positions around the residence. Knight stated that once a perimeter was set up, negotiations would be attempted.

Knight stated that while on scene, he learned that bullets fired by [REDACTED] hit two patrol vehicles. Knight stated he called the Sheriff and advised him that shots had been fired and Deputies had returned fire.

Knight stated that he also called Humboldt County [REDACTED] to try to get more information. Knight was advised that [REDACTED] was in [REDACTED] recently and while there, tore up the facility. The Eureka Police Department responded and [REDACTED] was booked into jail. [REDACTED] then went back to [REDACTED] and was later released. Knight stated that he requested [REDACTED]. Knight stated that [REDACTED] responded from Fortuna. The exact time that [REDACTED] on scene should be in the dispatch records.

Knight stated that at some point, he talked with Lt. Morey and Lt. Cavinta about getting some relief for the next day and night. Knight stated he called Sergeant Bill Nova from the Eureka Police Department for assistance. Nova is the team leader for the Eureka Police S.W.A.T. team. Nova returned his call and agreed to respond for assistance.

Knight stated that about 10 pm or so, he was advised that all negotiation attempts had failed. It was decided that negotiations would be suspended until the following morning.

Knight stated that he talked with [REDACTED] about [REDACTED] at the scene. [REDACTED] lth advised him that [REDACTED] was a [REDACTED]. Knight stated that [REDACTED] advised that she was surprised that [REDACTED] was even [REDACTED]. Knight also stated that if [REDACTED] was using [REDACTED], it would negate [REDACTED] he was [REDACTED] and cause problems.

This interview was recorded via digital recorder. Refer to typed transcript of interview for exact details, as above narrative is only a summary of entire statement.

Interview with Deputy Tony Gomes

On 6-6-07 at about 1548 hrs I met with Deputy Tony Gomes and his Attorney [REDACTED] at the Sheriff's Office. Also present was Detective Rich Schlesiger. The interview was recorded with Gomes and his Attorney's knowledge and consent via digital recorder.

Deputy Gomes was identified as one of the Deputies who fired his rifle at [REDACTED] in the residence. The following is a summary of his statement:

Gomes stated he has been a Patrol Deputy for about 2 1/2 years. For about the last two months, Gomes has been a member of the County S.E.T. team. Gomes stated he was contacted by pager and advised that the SET team was being called out for a detail. Gomes called Humboldt County S.O. dispatch and confirmed the call-out and was told to wear camouflage and meet at the Sheriff's Office for briefing. While at the Sheriff's Office, Gomes was advised that the team was going to respond to a [REDACTED] [REDACTED] in Hoopa. The [REDACTED] was identified as [REDACTED]. Gomes was advised that Deputies had responded to the location in Hoopa earlier and [REDACTED] pointed a firearm at them, then barricaded himself inside the residence. Gomes stated that he responded to the location with Deputy Todd Fulton at about 1700 - 1830 hrs.

Once on scene, as they were driving up, Gomes heard via police radio that shots were fired. Deputy Fulton and Gomes were told to expedite, because they were pulling a trailer that contained all the S.E.T. team's gear. Gomes and Fulton pulled down a road near some patrol vehicles that were parked. Sgt. Quenell, team leader for SET, met with them and told the members to get geared up and ready.

While on scene Gomes approached some patrol vehicles parked along the driveway to the house where [REDACTED] was. While at the vehicles, Gomes noticed some bullet holes in the patrol car windshields. Gomes stated that he was told that just before he arrived, Deputy Brian Taylor shot once at the residence because the [REDACTED] had fired multiple shots at him from a window. Gomes said his primary job was perimeter containment.

Quenell had some members respond down closer to the residence, nearest the Hoopa Tribal Police vehicle parked in the road. The Officers were identified as himself, Brian Quenell, Brian Taylor, Jaime Barney and Jesse Taylor.

Negotiators responded down and started negotiations. Gomes stated maybe a half hour had passed when negotiators came down. Gomes was on the passenger side door of the first patrol vehicle. Gomes also used a ballistic shield as a cover, along with the patrol vehicle door.

While down at his location, there were times where Gomes stated he could hear and see [REDACTED] in the residence. Gomes stated that [REDACTED] would "hoot and holler" every once in a while. Gomes once heard [REDACTED] say, "come get some fuckers". [REDACTED] also made a comment about

grenades, but the statements didn't make sense. Gomes stated he could not tell if [REDACTED] was responding to negotiations / negotiators or not.

Gomes stated that about 2030 hrs, he saw some unknown object in the "4a" (from diagram shown by Detective Schlesiger) window, push and open the window. Gomes stated her heard a gunshot and "felt" the vehicle he was at get hit. After the shot, Gomes stated that he got a site picture on the window and fired two quick shots into the 4A window. Gomes stated he thinks other Deputies may have fired as well, because he could hear them. Gomes stated after he and other Deputies fired into the house, he could hear [REDACTED] in the house running through the house crashing around, then it stopped and he did not hear anything else.

Gomes stated he stayed at his location until about 0400 hrs, when the EPD Swat team relieved him. Gomes stated that he responded to the Hoopa substation and rested for about an hour and a half or so. Gomes stated that he responded back to the scene and relieved the EPD Swat team about 0800 or 0830 hrs. Gomes stated when he was back at the scene, he heard Sergeant Quenell and Lt. Cavinta talking about introducing gas into the house. Gomes stated he did not introduce gas, other members of the team did it. Gomes stated that after gas was being introduced into the house, he could hear negotiators attempting to talk to [REDACTED]. Gomes stated that after a while, he could see gas coming out of the east window of the house. Gomes stated it started to look like smoke. Gomes stated that he heard negotiators on the PA now telling [REDACTED] that he needed to come out because the house was on fire. Gomes stated that the smoke was getting thicker and thicker. Gomes stated that the negotiators were trying to talk with [REDACTED] "pretty much non-stop".

Gomes also stated that when the house was burning, there were several rounds going off in the house that sounded like "gun shots". Gomes did not think it would have been safe for the fire department personnel come down and start extinguishing the fire.

The interview ended at 1646 hrs. This interview was recorded via digital recorder. Refer to typed transcript of interview for exact details, as above narrative is only a summary of the entire statement.

Interview with Deputy Brian Taylor

On June 7th, 2007 at 0925 hrs, I assisted with an interview of Deputy Brian Taylor. Detective Rich Schlesiger and Taylor's Attorney, [REDACTED] was also present. The interview was conducted in the conference room at the Humboldt County Sheriff's Department.

Taylor was advised that Detective Schlesiger and I had been assigned to the CIRT team and would be questioning him about the recent incident involving the Officer involved shooting of [REDACTED]. Taylor was aware that his statement was voluntary and being recorded via digital recorder.

Deputy Taylor stated that he had been a Deputy for about 5 years and was currently assigned to the Hoopa station as a resident Deputy. Taylor is also a SET team member. Taylor stated that about 4 pm, he received information of a SET team call out for the Bald Hill and Pine Creek area. Taylor was advised that a possible [REDACTED] was brandishing weapons at Deputies. Taylor stated that he responded directly to the location from his residence. Taylor stated that he believed the residence was that of [REDACTED]. Taylor believed it was about 1700 to 1730 hrs. Taylor stated that when he arrived on scene, there were possibly four vehicles on scene. That included Sergeant Miller and a Tribal vehicle. There were two others in front of those.

Taylor stated that Deputy Berry and an Officer Landernaux from Yurok Police were on scene. Taylor stated he was told that the Officers were there for a welfare check of [REDACTED] then came out of the residence brandishing a rifle and was acting crazy.

Taylor stated that he responded to the front patrol vehicle, driver's side door and took a perimeter position. Taylor stated that he had his department issued M-16 rifle with him. Taylor stated while at this position, about after 15-30 minutes, he heard [REDACTED] yelling from inside of the residence. Taylor stated that [REDACTED] came to the "A" window (refer to diagram). Taylor stated it looked like [REDACTED] was wearing a maroon colored shirt and beige, Indian style cap. Taylor stated [REDACTED] shouted, "I'm gonna start cappin you all, I'm gonna grab my M-16". Taylor stated that about 15 minutes later, he saw a black rifle barrel poking out of the window. Taylor stated that two shots were fired at him, so he returned fire. During this time, Taylor was kneeling at the driver's side patrol car door. Taylor stated that the window [REDACTED] fired from was about 65 feet from his location.

Taylor stated after the shots, he saw a bullet hole in the windshield of the patrol vehicle he was at and the patrol vehicle behind him. Taylor stated that after the shots were fired, he stayed at his position for cover as the remaining SET team members were arriving on scene. Taylor stated that later, he was relieved of his position by others SET team members. Taylor stated after being relieved of his position, he and other members walked around to where Deputy Berry and Officer Landernaux were. Taylor stated that Sergeant Garcia, Sergeant Miller and Deputy Fulton were with him. Taylor stated that while at this location, he could hear negotiators "on-going". It was at this location that Taylor also heard the second volley of shots exchanged by [REDACTED] and Officers. Taylor stated that he had a clear view of the number 2 window and the number 2 side.

Taylor states that after the second volley of shots, he could hear loud screaming from in the residence as if [REDACTED] was possibly hit. Taylor stated it sounded like, "either pain and or one or the other". Taylor stated that he held his position until about 3 am when EPD SWAT team members arrived and relieved him. Taylor stated the he returned to the Hoopa substation and ate a sandwich and took a break. Taylor stated he returned to the scene about 6 am.

Taylor stated he was now positioned at the group of vehicles parked along the driveway. Taylor stated that it was decided by the Lt. to introduce gas into the residence. Negotiations were also still on going. Taylor stated that the initial plan was to introduce gas into the A and B windows,

located on the # 4 side. Taylor stated the he deployed the gas, using a 37 mm less lethal launcher. Taylor stated that the first volley of rounds were ferret rounds. Taylor stated he was supposed to get five good rounds into the A and B windows. Taylor stated that he was about 75 feet away from the house. The effective range is 50 feet. Taylor stated eventually, they were successful in getting the rounds in, however, it took many attempts. Taylor stated if he had to guess, there were about 20 rounds actually fired, 10 of which it the target area.

Taylor stated there was a second volley of gas fired at the residence. The plan was the same, 5 in the A and B windows again. Taylor stated, "we had basically exhausted our supply at that point". Taylor stated that there was actually a third volley of gas, but it was not successful. The gas used was not good and never made it to the residence. Taylor stated that Deputy Barney fired the third volley.

Taylor stated that they attempted to break out the windows in the residence in anticipation of my volleys. Taylor stated that there was talk of using expulsion grenades, but that would not be done if the windows were intact. So, a third volley was fired, used to assist in breaking the windows. Taylor stated that they were successful in breaking most of the windows out. Taylor stated during each of the volleys, surrender orders were being given continuously.

Taylor stated CDC personnel arrived and provided them a ballistic blanket and 5 CS grenades. Taylor stated the CS grenade is a non-burning, non-flammable cylinder, about 6 to 8 inches in length that uses a pin to activate. Taylor stated it's a powder agent.

Taylor stated that he then assisted with approaching the residence and deploying gas into the residence with the grenades. Taylor stated that he helped hold the ballistic blanket, as other members of the SET team used it for cover. The members of the team approached the residence, and Deputy Barney activated one of the grenades and tossed one into window "A" and one into window "B". Afterwards, the team retreated back to the patrol vehicles. Deputy Taylor stated that Lt. Cavinta then wanted EPD SWAT team to introduce gas into the other side of the residence. EPD refused, stating that it was too dangerous.

CDC personnel brought munitions down to them as they were out. Taylor stated there was smoke, CS cans, pyrotechnics and others. Taylor stated his team again responded to the residence, using the ballistic shield as cover and deployed more gas. Taylor stated he did not know what specifically was used. Taylor stated he believed that one of the grenades used was a "tri-chamber". Taylor stated that the tri-chamber is a pyrotechnic technically, but it is a non-flammable pyrotechnic for indoor use. Taylor stated, "again, I was told what it was, I did not actually look at it and confirm what it was". Taylor stated that he could see the smoke activating, then eventually, it dissipated and was gone. Taylor stated they were still continuing negotiations.

Taylor stated he remembers a CDC person stating the smoke was starting up again. Taylor stated the smoke changed colors and he realized that it was not CS smoke, but a fire. Taylor stated that Sergeant Fridley got on the PA and began to tell [REDACTED] that it appeared the house was on fire

and he needed to get out. Taylor stated there was never a response from [REDACTED] Taylor stated eventually, the house becomes fully engulfed in fire.

The interview ended at 1022 hrs. This interview was recorded via digital recorder. Refer to typed transcript of interview for exact details, as above narrative is only a brief summary of entire statement.

Interview with Deputy Jamie Barney

On June 7th at about 1034 hrs, I assisted with interviewing Deputy Jamie Barney. Detective Schlesiger led the interview with Barney's attorney present, [REDACTED]. The interview was conducted in the Sheriff's Department conference room.

Barney stated that he has been with the Sheriff's Office for about nine years, three as a Deputy, six as a Correctional Officer. Barney is also a member of the SET team. Barney has been with the team since March of this year. Barney stated that he went to a two-week SWAT school in Sacramento. In April, Barney went to school for gas deployment with Armored Tech.

Barney stated that on the day of this incident, he was on his way to work. Barney stated that he was working a swing shift. Barney stated that he heard about the incident, went home to get his gear and returned. Barney stated there was a very small briefing about the incident. Barney stated that he heard some Deputy's were doing a welfare check. During the contact with the [REDACTED] he exited the house with some knives and a rifle.

Barney stated that he and Deputy Bishop responded to the location in Hoopa, arriving about 1630 hrs. Barney stated that when he arrived, he heard what sounded like a couple of gunshots. Barney stated that got his rifle, charged it and began to gear up. Barney stated that Sgt. Quenell was in charge at this time. Barney stated that he went up to some vehicles in front parked on the driveway that access's the residence (see diagram provided by Det. Schlesiger). Barney stated that the Hoopa Police Chief and Deputy Taylor were there, on the same side of the patrol car as he was.

Barney stated that within about one hour, Deputy Daniels and Sgt. Fridley arrived to start negotiations. Barney stated he believed that they used the PA on the second patrol vehicle, parked at the front. Barney stated that he heard what he would call, "hooping and hollering" from inside of the residence. Barney stated once, he heard [REDACTED] shout, "come get me mother fuckers".

Barney stated that at his position, he rotated back and forth with Deputy's, holding cover of the residence from the patrol car door. Barney stated he saw [REDACTED] come to the window at the residence. Shortly later, he heard two shots. Barney stated they sounded like the shots he heard before, when he arrived on scene. Barney stated that he heard Quenell shoot. Barney stated got a

sight picture at that time, then fired two rounds. Barney stated that he maintained his position after shooting. This included throughout the night. Barney stated at times he would use night vision goggles to watch the residence.

Barney stated that he could see [REDACTED] inside of the residence moving around. Barney describes seeing some "weird flickers". Barney stated it could have been the T.V. Barney also states that a couple of times, it appeared that [REDACTED] came to the window with his flashlight and shined it out of the window.

Barney stated that at about 0300 hrs or so, he is relieved of his position by the Eureka P.D. SWAT team. Barney stated he takes a short break and was back at the scene about 0600. Barney stated he went back to his same position, the front, parked patrol vehicle. Negotiations are on going. Barney stated that he does not see or hear anything from the residence.

Barney stated that a decision is made to introduce gas into the residence. Barney stated that the first operation was going to be five rounds of gas into the A and B windows. (see diagram). Barney stated that he and Deputy Brian Taylor were going to be in charge of deploying the gas. Barney stated they used 37 mm, single shot launcher to deploy the gas. Barney stated there was also a 12-gauge launcher as well.

Barney stated that the rounds are effective at 50 yards, per a school he went to. The estimated distance they would have to shoot was 75 yards. It was later determined with the assistance of a laser finder that the actual distance was 65 yards. Under these circumstances, it would be better to launch from the location because there was better coverage. Barney stated that Deputy Taylor launched the gas first. The plan was to get five rounds into each window. Barney stated that he and Taylor shot about 15-16 rounds total to reach that amount. The inaccuracy was due to the distance and the wood siding. There were also some misfires as well. Barney stated they just fired until they had five in each window. Barney stated that Taylor started the first volley and the second volley. Barney stated that he finished the second volley.

After these volleys, EPD came down and used the shotgun rounds. He and Taylor also used shotgun rounds. Barney stated that part of the reason to use shotgun rounds was to break out the windows. Barney stated that during all of this, he does not hear any response from inside. Barney stated that after each of the volleys, they would negotiate for about 15-20 minutes.

Barney stated that at about this time, he heard from Sgt. Quenell that they were going to toss gas grenades into the residence. Barney stated that CDC had a blanket on a pole (ballistic blanket). CDC covered them as several Deputies approached the residence on foot and threw grenades into the windows. Barney described the grenade as similar to the 37 mm, except its deployed by hand. Barney stated you just throw it in and it sprays out. He further stated they were CN gas, smokeless and burnless.

Barney stated that he walks with the team to the "A" window, throws the grenade, then he walks

to the "B" window and throws one in. Barney states that he never heard anything from inside of the house during this time. Barney stated that they negotiate some more and some of the CDC people suggest using smoke grenades. It was described as an agent that carries better than the straight gas or aerosol type.

CDC then brought down a vest that's loaded with many kinds of different types of CS and grenades. Barney stated that one was a triple chamber. Barney stated that he used a triple chamber at school and it was non-pyrotechnic and fairly safe. Barney stated that he takes the vest and puts it on. At some point, it is decided that he does not need to wear the vest. Barney also asked to make sure that all the pyro-type grenades were removed, as they would definitely start the house on fire. Barney stated that as he removes the vest, a CDC person gave him a sting ball. Barney states the sting ball would provide a more psychological effect, so he uses it.

Barney states he approaches the residence a second time. He reaches the "A" window and throws a triple chamber CS gas grenade inside. Barney then approaches the "B" window and throws the sting ball in. After, he throws a second triple chamber. Barney states when he throws the second one, it hits the divider of the window and bounces out. Barney states he watches Sgt. Quenell walk around the blanket, pick up the triple chamber with his hand and throw it back in the residence. Afterwards, Barney stated they go back to the vehicles. Barney stated that the grenades used in the second volley belonged to CDC, not HCSO. This would include the two tri-chambers and the sting ball.

Barney states that surrender orders are still being given to [REDACTED] Barney states he can see the smoke. He describes it as a light gray color and not real thick. Barney stated the gas was going off for a good four or five minutes. Barney stated that he remembered that the smoke stopped. Barney then stated that the smoke started again, this time it was darker. Barney stated that it appeared to be smoke from a fire. Barney states he remembered the negotiators telling [REDACTED] "looks like a fire in there, you should come out now- should come out now".

Barney stated after a while, he saw the fire in the residence. He stated the residence eventually became fully engulfed. Barney stated he heard all kinds of popping sounds and crackling sounds. He also heard what sounded like a muffled gunshot. Barney stated he thought the [REDACTED] might have taken his own life.

The interview ended at 1132 hrs. This interview was recorded via digital recorder. Refer to typed transcript of interview for exact details, as above narrative is only a brief summary of entire statement.

Interview with Sergeant Brian Quenell

On June 7th, 2007 at about 1304 hrs, I assisted with an interview of Sergeant Brian Quenell of the Humboldt County Sheriff's Office. Detective Rich Schlesiger and Quenell's Attorney, [REDACTED]

██████████ were also present. The interview was conducted in the conference room at the Humboldt County Sheriff's Department.

Quenell was advised that Detective Schlesiger and I had been assigned to the CIRT team and would be questioning him about the recent incident involving the Officer involved shooting of ██████████. Quenell was aware that his statement was voluntary and being recorded via digital recorder.

Quenell stated he had been a Deputy Sheriff for 11 years and is currently a Sergeant. Quenell is also a team leader on the Sheriff's Office SET team. Quenell stated he was notified at home and advised that the SET team was being paged out. Quenell believed it was sometime around 4 pm. Quenell was advised to wear his camouflage uniform and meet at the office. Quenell stated that he was advised that the call started as a welfare check of a ██████████ ██████████ was apparently inside and brandished guns at Officers on scene.

Quenell described the SET team structure as Lieutenant Cavinta being the team commander, with Sergeant Garcia and himself being team leaders. Quenell stated that Jesse Taylor was assigned as his assistant team leader. Sergeant Miller would have been Sergeant Garcia's assistant team leader.

Quenell stated that he rode to the incident location with Officer Taylor. Quenell stated that he arrived on scene about 1823 hrs. Quenell stated that almost immediately after he exited his patrol car, he heard gunshots. Quenell stated he heard three shots. Quenell stated that he grabbed his rifle located in the trunk and notified dispatch that shots were fired. Quenell also requested that Deputy Fulton expedite his response. Deputy Fulton was bringing a trailer to the location that carried all the SET team members gear. When Deputy Fulton arrived with gear, he got ready and began getting the team ready. Quenell stated he was the person in charge at this time. Quenell stated that he broke members of the team into three elements to relieve officers on scene and provide some containment of the residence.

Quenell stated that on his team, he had Deputy Jesse Taylor, Deputy Gomes, Deputy Barney and Deputy Massaro. Quenell stated he moved his team up to the first parked patrol vehicle along the driveway. Quenell stated that Sergeant Garcia's team responded to assist a Yurok Tribal officer and a Deputy that where on the opposite side of the residence trapped in. Garcia's team traversed through some neighboring property, went through several fences and met with the officers to relieve them.

Quenell stated that while at his location, the patrol vehicles, he could hear movement inside the residence. Quenell also stated he saw bullet holes in the windshields of the patrol vehicles. Quenell stated that Sergeant Fridley and Deputy Daniels were also at his location now assisting with negotiations. Quenell stated that at about 1905 hrs, negotiations began over the PA. Quenell stated that these negotiations were continuous. Quenell stated during this time, there were reports of yelling from inside, but from his location he did not hear this. Quenell stated that Lt. Cavinta

arrived on scene about this time and was in charge of formulating plans.

Quenell stated that at about 2058 hrs, his team observes [REDACTED] near a window, armed with a rifle. Deputy Ireland initially reports this from his location, in some brush. (this location is marked on a diagram for clarification). [REDACTED] is in the 4A window. Quenell stated he can see what looks like a barrel pointing out of the window with a white rag tied to the end of it. Quenell then hears a gunshot and hears the bullet ricocheted off the front of the patrol vehicle he is behind. Quenell stated he ducked down for a second, popped up and looked at the window again. Quenell could see the gun barrel and part of [REDACTED] arm. Quenell stated he fired one round. [REDACTED] continued standing there and Quenell fired one more round. Quenell stated afterwards, he heard a loud "thud" inside. Quenell then heard reports from Sergeant Garcia at a different location, that [REDACTED] had moved to the back of the house and was screaming and yelling. [REDACTED] had also turned some lights off.

Quenell stated due to the darkness at this time, Deputies could not get a good visual, so they moved in closer. Quenell stated there were reports that [REDACTED] was inside lighting a fire, then occasionally, someone would report hearing [REDACTED] yelling and screaming inside. Quenell stated he believed it was Deputy Bishop reporting that he could see [REDACTED] making a fire through his night vision goggles. Quenell stated that at this time, it was too dark to see inside, including what a person was wearing. Quenell stated that he talked with Lt. Cavinta and due to the darkness, they decided to lock it down until daylight. They would move forward with negotiations later. Quenell stated he heard that the Eureka Police SWAT team was enroute and would assist with relief around 0200.

Quenell stated about 0313 hrs, EPD arrived, moved in and relieved Deputies from the scene. The Deputies then respond to the Hoopa sub-station and eat and take a break. Quenell stated he did not get any sleep. Quenell stated that while he was at the sub-station, he and Sgt. Garcia worked on an operation plan to present to Lt. Cavinta. Once back at the scene, he gave it to Lt. Cavinta. Quenell stated that the plan was basically to continue to negotiations in the morning. If negotiations failed, they wanted to introduce gas.

Quenell stated that it was decided to keep EPD in place until about 0800. The teams would be switched and they would continue with the ops plan he and Sgt. Garcia drew up. The teams were switched since gas was going to be used. Quenell stated that the grenadiers for SET were Brian Taylor and Jamie Barney. Quenell wanted then both on his team. Jesse Taylor was also on his team. Quenell stated that negotiations began again about 0850 hrs by Sgt. Fridley. Additional assistance was also on scene at this time, which included members from the California Department of Corrections (CDC). CDC even assisted some with negotiations, using a bull horn for communications.

Quenell stated that negotiations were not working and he met with Lt. Cavinta. It was decided that gas would be used. Quenell responded back to his team and advised the grenadiers to get their gas equipment ready. There had been a 30-minute time line for gas deployment, but that

was delayed by Lt. Cavinta who was trying to get a helicopter and requested he respond back to the command van. Quenell stated the final decision was made by Lt. Cavinta to introduce gas.

Quenell stated he was going to use 37 mm ferret rounds (CS gas). The plan was to get 5 into each window on the A and B, #4 side of the house. (refer to diagram for further). Deputy Brain Taylor then deployed the gas. Quenell stated that several rounds were fired because there were two "duds" and one misfire. Quenell was not sure exactly how many were fired, but eventually 5 were shot into each window.

Quenell stated that there was no response from the house. Then, EPD was asked to introduce gas on the number 2 and 3 side of the residence. The EPD team then moved into a position to deploy gas. Quenell stated that Taylor did a second volley and they ran out of 37 mm. Quenell stated he contacted Lt. Cavinta and advised he would have to switch to the 12 gauge rounds. Deputy Barney also assisted with the second volley. Quenell states that negotiations are continuing and still no response.

Quenell stated that Lt. Cavinta got on the radio and asks about the probability of deploying chemical agent grenades (hand held) inside of the residence. Quenell states at this point, he starts a plan to get close enough to the residence to deploy those. Quenell states he told Lt. Cavinta that the #A window was shot out so one could get in that window. The #B window still had glass in it, so he used ferret rounds to break out the rest of the window. Once that window was open, he told Lt. Cavinta that he needed more team members to assist with cover for the approach. The area of approach was a large open area. Quenell was concerned about [REDACTED] shooting at the team while they were exposed to the open area.

Quenell stated that he used a ballistic blanket on a pipe pole for the approach. The ballistic blanket was provided by CDC. Quenell stated that the team consisted of Deputy Massaro and Brian Taylor on the ends, holding the poles. Deputy Jesse Taylor, Barney and himself were behind the blanket. CDC team members were back, providing cover. The plan was to get close to the residence and throw a flameless expulsion grenade into the window. Quenell stated that his team walked down the road, past a barbed wire fence. As soon as they passed the fence, the team turned the blanket perpendicular with the residence and moved towards it. As the team got close, Deputy Barney deployed a flameless expulsion grenade into the #A window. The team moved down to the #B window and the second grenade was deployed there. Quenell stated his team retreated the same way they came in.

Quenell described the grenade as a CO2 canister. There is a pin that's pulled with a spoon release. This action causes a small CO2 canister to go off inside. This disperses the chemical agent inside of the room. Quenell stated that he believes the CDC team leader was talking to him about some hand held chemical agent grenades that were rated for indoor use. The grenades had a smoke element to them. The smoke apparently helps move the chemical agent further inside of the residence. Quenell stated that CDC suggested he use those grenades. Additionally, Quenell stated that CDC and the team went to the command post and met with Lt. Cavinta. A short time

later, Cavinta told Quenell via radio, to use the CDC canisters that were tri-chamber, flameless grenades. Quenell stated that CDC responded back to his location with a black tactical vest that contained two flameless grenades, a stinger grenade and two pyrotechnic grenades. Quenell stated he decided to use the two flameless and the stinger grenade and they made an approach again.

Quenell stated that to make sure there was not any potential for the team to accidentally deploy a pyrotechnic flammable grenade, they removed the items from the CDC vest and placed them on Deputy Barney's tactical vest. Quenell stated that this was so that the only gas that was present (on Barney's vest) was the tri-chamber flameless and the stinger grenade.

Quenell stated that his team used the CDC ballistic blanket again and he moved towards the house the same as the first approach. Quenell stated that as the team approached the A window, Deputy Barney introduced the tri-chamber flameless grenade. The team then moved to the B window and Quenell told Barney to deploy the stinger grenade. Quenell stated that this was because the "approach" was a pattern, and he was hoping to keep [REDACTED] out of the room. Afterwards, Barney deployed the second tri chamber flameless grenade. The grenade bounced off the window and landed in the grass. Quenell stated that he picked up the grenade and threw it back through the window. Afterwards, the team returned to the perimeter. Quenell stated that when the tri-chambered grenades went off, they emitted a dense white smoke. Quenell stated that's the type of smoke he saw exiting both windows.

Quenell stated that CDC covered his position and he went back to meet with Lt. Cavinta. Cavinta told Quenell that he was working on a plan to get the FBI involved and have them bring up some armored personnel carriers. Quenell stated that his team was scheduled to leave a 1700 hrs that day, the return later to assist the FBI in the morning. Quenell stated that at this time, CDC advised that they could see black smoke coming from the windows. Quenell stated that he believed the CDC team leader stated they saw [REDACTED] in the house lighting a fire. Quenell went back to his location and could see the smoke. Quenell stated that the smoke was coming from both windows. Quenell also stated that Sgt. Fridley was on the PA telling [REDACTED] that he needed to exit because the house was possibly on fire.

Quenell stated that he started to see flames coming from the B window and hitting the eave of the roof. Quenell stated that about 30-45 minutes passed from the time black smoke was seen and the home was fully engulfed. Quenell later stated that when the house was burning, he could hear gunshots. Quenell stated he could not tell if the shots were been fired at him or just rounds "cooking" off due to the fire.

Quenell stated that he is trained in SWAT, which includes a 40-hour advanced SWAT, 40 hours SWAT team leader and 48 hours tactical deployment officer. Detective Schlesiger asked Quenell as a team leader, why family members of [REDACTED] were not allowed to talk with him. Quenell stated that this would put family members in a very dangerous situation. The family would have been in the line of fire and it could "agitate" the situation. Quenell stated that it could create a

violent situation. Quenell also talked about not knowing the history between a family member and a [REDACTED] it could be that person that "set the person off".

Quenell stated that the SWAT team did not try to enter the home and subdue [REDACTED] as it was too dangerous. This is also due to information that there were a number of weapons in the residence. This included an AR-15, AK-47 or SKS rifle, and a .22 rifle with a scope. A silver revolver was also seen through a window.

Quenell stated that there had been a decision if the SET team was approaching and the rounds were fired at them, Pyrotechnics would be used. LT. Cavinta had authorized this. Quenell stated that none were used, in fact, none were taken with the team as they approached.

Sergeant Quenell stated that when he was near the Police cars and he heard shots ring out, he was in fear for his life. Quenell stated that he believed [REDACTED] was trying to kill him and his team members.

Quenell stated that all SET team training records are available as are the dispatch logs, recorded at the scene by Dispatcher [REDACTED]

The interview ended at 1412 hrs. This interview was recorded via digital recorder. Refer to typed transcript of interview for exact details, as above narrative is only a brief summary of entire statement.

Interview with Lieutenant George Cavinta

On June 8th, 2007 at about 1131 hrs, I assisted with an interview of Lt. George Cavinta. Lt. Cavinta was the commanding officer of the entire Hoopa incident. The interview was lead by Detective Schlesiger and took place in the Sheriff's Department conference room.

Cavinta stated he has been employed with the Sheriff's Office since 1984. Cavinta is currently the Lt. in charge of the Criminal Investigation Division, the Commander of the EOD (explosive ordinance division) and the SET team (special enforcement team). Cavinta stated that he has been a member of the SET team since 1989. He became team leader in 1997. In 2003, Cavinta attended the FBI Commander School in Monterey California.

Cavinta stated that there are currently 12 members on the SET team, which has three leaders. The leaders are Sgt. Miller, Sgt. Quenell and Sgt. Garcia. Cavinta identified the team snipers as Deputy Ireland, Deputy Bishop and Sgt. Miller. Sgt. Miller is a grenadier, as are Deputy Brian Taylor and Deputy Barney. Cavinta stated that the team has monthly training, all of which is documented.

Cavinta stated that on June 3rd, 2007, he received a call from Lt. Knight at about 4 pm. Knight

advised him about a situation occurring in Hoopa. The Sheriff had been contacted and he advised Cavinta of some details since he was the SET team Commander. The area was described as the Bald Hills area, off Pine Creek road, on Bloody camp road. Cavinta stated that members of the team are contacted on a call out and advised what type of tactical gear needs to be worn. Members are deployed, as is the SET team trailer carrying the gear. Cavinta had also contacted Sgt. Quenell and was advised that he was taking care of the deployment. Deputy Fulton, a team member was assigned transportation of the teams trailer. Cavinta stated he responded by himself to the scene.

Cavinta stated that he had many conversations while enroute the scene. This included conversations with Lt. Knight. Cavinta stated that when he arrived on scene, Deputy Mabree met him. Mabree advised Cavinta that the mother of [REDACTED] was on scene, as was the father, [REDACTED] [REDACTED]. Cavinta stated that the incident had already been going on for about one and a half, to two hours by this time. Deputies had been setting up a perimeter and scene containment and the family was concerned about what was going on.

Cavinta stated he talked with [REDACTED] mother, [REDACTED] while at the scene. [REDACTED] advised Cavinta that it was her son in the residence [REDACTED] stated that her son had been recently transported [REDACTED] in Eureka for "odd behavior". [REDACTED] was then released and he got involved with some type of activity that involved the Eureka Police Department booking him in jail. [REDACTED] was then placed [REDACTED] and again released in the same condition. [REDACTED] was upset about the release and that [REDACTED] did not receive any assistance. Cavinta explained to [REDACTED] that negotiations were primary, and his goal was to reach a peaceful resolution.

Cavinta stated he also talked with a person identified as [REDACTED] [REDACTED] [REDACTED] biological father [REDACTED] and [REDACTED] [REDACTED] were no longer married. Cavinta stated that he had been only talking to [REDACTED] for a few minutes when he heard gunshots. Cavinta stated he heard several gunshots, less than ten. Cavinta stated that he advised the parents to stay at their location and he needed to go to work. Cavinta wanted to establish a better perimeter and work on containment of the property.

Cavinta stated he learned that Deputy Brian Taylor was at the lead vehicle parked in the driveway and had returned fire. Cavinta stated that at this time, he walked down the driveway, closer to the house. Cavinta stated that there were several cars parked along the driveway. Cavinta stated that Sgt. Fridley arrived on scene about this time. Fridley was the resident Sgt. for the area and was also a negotiator on the team. Cavinta stated that he introduced a person named [REDACTED], who was also on scene, with Sgt. Fridley. [REDACTED] was apparently the mother of [REDACTED] [REDACTED] [REDACTED] biological father. This allowed Fridley to gather information about the incident and [REDACTED]

Cavinta described, as he remembered, where people were at the scene. Cavinta stated that Deputy Berry was on the opposite side of the residence with two tribal Officers. They were identified as

Tribal Officers Heather Landernaux and Matt Spilino. The Officers were also with a witness, later determined to be the actual homeowner, [REDACTED]. Cavinta stated that a team was assembled to get those [REDACTED] out of that area and relieved. Also, Cavinta was starting the process to get communications going with [REDACTED] via telephone, throw phone, ect.

Cavinta stated that negotiations started with [REDACTED] at about 1905 hrs. Sgt. Fridley and Deputy Daniels were the negotiators. They started with using the PA. Lt. Knight also arrived on scene and his position was to run the negotiations part and handle logistics. Humboldt County Mental Health was notified and Lt. Knight also made a request for a CIRT team response at this time. CIRT is the "Critical incident response team". Cavinta stated that he was trying to formulate teams and establish personnel on scene at this time. Tactical Dispatchers were also arriving. The command post location was established and placed at the end of the driveway and the Bloody Camp road intersection.

Cavinta talked about the difference of negotiations and surrender orders. He described negotiations when there is an open dialogue, on-going discussions or two-way conversations with an individual barricaded in a house. Cavinta described this as more of an active shooter situation. [REDACTED] had brandished a firearm and later fired the firearm at Deputies. [REDACTED] would periodically yell out threats and there were not open negotiations. Cavinta stated that the only thing he could tell [REDACTED] was that he needed to come out of the house, surrender and follow the directions of the nearest officer. Cavinta stated that those requests were made for the 28 hrs Deputies were on scene. Cavinta stated, "It went on, over and over".

Cavinta stated that during negotiations, there was a second round of shots fired. Cavinta stated that he was dealing with logistics and manpower, getting the background of [REDACTED] and talking with family members. Deputy Fridley was continuing to give surrender orders and he heard what he describes as a "tumbling round" travel through the air over his head. Afterwards, he heard follow up gunfire. Cavinta stated he learned that three Deputies had returned fire. Cavinta did not know how many rounds were fired.

Cavinta stated that getting a throw phone to [REDACTED] for communications was discussed, however, would have been very unsafe. Cavinta stated they decided to just continue with surrender orders. Cavinta stated that they learned they phone in the house had been disconnected. Cavinta stated that they learned later it was actually a Verizon wireless phone and there was no hard phone line in the home.

Cavinta stated that second shots fired occurred at about 9 pm. Cavinta stated he was working on getting more information on how to get [REDACTED] to talk with him. Cavinta stated they worked throughout the night, however, [REDACTED] would not respond. Cavinta stated that at dark, negotiations stopped. This was due to the fact that if [REDACTED] did come out of the house, the Deputies would not be able to see him. Cavinta stated that the teams stayed in place over night until about 5 am. At this time, EPD SWAT team arrived and relieved the SET team members to give them a break.

Cavinta stated that the team responded to the Hoopa substation and took a break there. Cavinta stated that he remained at the Command van, on scene. Cavinta stated that when EPD SWAT was on scene, he still assumed command. Cavinta stated at this time, there was a lot of information flowing. Cavinta stated that the prior evening, Lt. Morey, the negotiations Commander who had not yet been on scene, had been in contact with the California Department of Corrections negotiations team (CDC). The negotiations teams had apparently trained together in the past and Morey was aware of their vast experience. They also could offer other resources, such as throw phones, audio and video equipment. The CDC team agreed to assist and they would be coming from crescent City. They were going to meet Lt. Morey at 0600 hrs, then commute to Hoopa.

Cavinta stated that the plan with the team leaders was discussed that this was an active shooter situation. Cavinta stated that they could only deal with surrender orders. Cavinta stated that Humboldt County [REDACTED] representatives had arrived on scene and were present throughout the night. The [REDACTED] representatives also agreed that the best type of negotiations advised at this time would be "surrender orders".

Cavinta stated that the two [REDACTED] workers were identified as [REDACTED] and [REDACTED]. [REDACTED] was the crisis worker unit supervisor for [REDACTED]. Cavinta stated that both workers were familiar with [REDACTED]. Cavinta stated that the workers were concerned and did give some information about [REDACTED]. This included information that [REDACTED] was [REDACTED]. Cavinta stated that the fact that [REDACTED] was not negotiating did not leave a lot of room for [REDACTED] assistance in the situation. Cavinta stated that he described his plans to [REDACTED] the following day, they agreed that it was the only action course that he could take.

Cavinta stated that EPD SWAT was pulled off line at about 0800 hrs. Cavinta stated that team members were assigned to groups in the event that he was going to continue on with the plan of introducing chemical agents. Cavinta stated that he had Sgt. Garcia in charge of the side one and two sides. Sgt. Quenell was in charge of the team and the three and four sides. Cavinta stated that this event was "truly a rolling operation". Everything was contingent on the actions of the [REDACTED]. Cavinta stated he was hoping that he would get some dialog with [REDACTED] while the CDC team was conducting negotiations. The CDC team used the PA system and a hand held amplified megaphone for about 30 minutes. CDC realized at this point that [REDACTED] was not going to negotiate with them. In addition to negotiators, CDC also had some tactical members.

Cavinta stated that when he planned to use chemical agents, he had Sgt. Fridley put back in position as negotiator. Fridley gave surrender orders for about 30 additional minutes. Cavinta advised that all of Fridley's surrender orders and any negotiations were recorded. Cavinta believed that there were as many as eight tapes, covering 28 hours.

Cavinta stated that gas was going to be introduced, but timelines changed. This was due to logistical reasons. Cavinta stated that he requested a helicopter on standby should it be needed

for medical evacuation. Cavinta stated he started introducing chemical agents at about 1120 hrs. Cavinta stated that decision was his. Cavinta stated that the amount of volley's or rounds used and where to be used was a joint decision. This would have included Sgt. Nova, of EPD SWAT, Sgt. Quenell, and Deputy Barney. Cavinta stated that he wanted calculations on the residence for "saturation". This was important due to the fact there were open and broken windows in the residence. Cavinta stated that he made the decision to deploy "10" 37 mm projectiles of gas into the number four side of the residence. Cavinta stated that ten independent barricade projectiles were shot at the residence. The team was given orders to shoot five into the A window and five into the B window. Cavinta stated that he hoped to get enough irritant in the residence to persuade the [REDACTED] to leave.

Cavinta stated that the amount of success was poor, in regards to how many projectiles actually made it in the residence. After the first volley, the teams waited about ten to fifteen minutes. There was no activity, no response in the home, so a second volley was fired. Cavinta stated that after the second volley, he remembered hearing that the [REDACTED] was crawling on the ground near the master bedroom and had a blanket over him.

Cavinta stated that after the second volley, he requested that EPD get into a position on the number two side, since this is where it appeared [REDACTED] had been driven to in the house. Cavinta stated he wanted to introduce some chemical agents on that side of the building. Cavinta stated that he wanted the [REDACTED] to come out the front door. Cavinta stated that there were units in position in case he did appear, however, all units were prepared to arrest or react to a situation if [REDACTED] would exit from anywhere in the residence.

Cavinta explained that many projectiles were fired at the residence. Many were also unsuccessful, this was do to many factors. Both Ferret and 37 mm rounds were used. Cavinta stated that he had a discussion with EPD Sgt. Nova and the discussed the dispersion rate of gas and that canisters me be more effective. The canisters have a higher level of saturation. Cavinta stated that a plan was made to have Quenell's team put an approach to the residence together. CDC provided a ballistic blanket to assist with this approach. Cavinta stated that the chemical agents to be used were nonpyrotechnic CS gas. Cavinta stated that at 1340 hrs, Sgt. Fridley advised that gas was inserted into the A and B window and surrender commands started again. Cavinta stated that there was no response. Cavinta added that there was product discharge at 1344 hrs. It was confirmed that there was good insertion and not too much blow out through the open windows on that side. Cavinta stated there was still no response from [REDACTED]

Cavinta stated they continued to saturate the residence and make it as unbearable and uncomfortable as possible to drive [REDACTED] out. Cavinta stated that more canisters were inserted into the A and B windows on the four side (refer to diagram). Cavinta stated that there was some discussions about pyrotechnics, but it was a very brief discussion. Cavinta stated that if the [REDACTED] should begin his active shooting as he had done on two prior occasions, it would be nice if pyrotechnics were available. Cavinta stated that only CDC had pyrotechnics and "speed heat". Cavinta stated that these were more intended for use on yards. It creates a high heat. There were

also two more canisters that were continuous release CS and he believed OC aerosol. Cavinta stated that from what he understands, CDC delivered a vest to Sgt. Quenell. Sgt. Quenell took inventory of what was in the vest. Cavinta understood that Quenell then returned the vest and all pyrotechnic items and sent them back to the command post. The team then made its second approach with canisters. The team deployed the canisters in the A and B windows and returned.

Detective Schlesiger asked Cavinta if he knew anything about a sting ball. Cavinta stated, "No", other than the speed heat that was showed in the van to Sgt. Nova and himself. Cavinta stated, "as far as us deploying a sting ball, no direction was given for that".

Cavinta stated that this entire time, he was at the command van looking at the situation with Sgt. Nova. Cavinta realized how much agent was in the house and the fact that he was unsuccessful in getting [REDACTED] to negotiate or surrender. Cavinta stated that there were several options at hand and one that was discussed was a port plan. This would be porting the windows of the residence. Cavinta stated that they would port in an active shooter situation, but would not do a dynamic entry into the residence. Cavinta stated that they had a barricaded [REDACTED] who was actively shooting. It would be a suicide mission to send a team into the residence knowing the firepower that [REDACTED] had in the house.

Cavinta stated that he decided at this point to take a closer look at the residence. Sgt. Nova accompanied him. Cavinta stated that he wanted to work on a second operational period. Cavinta stated that CDC agreed and could handle containment of the area until the following day, 0700 hrs. Cavinta stated that his goal was to gather some equipment, tow trucks, cables, chains and grapple hooks for the following morning. Cavinta stated he would then respond with EPD and fresh units that had some rest and sleep. He would work on a mechanical porting of the structure. Cavinta further planned ahead by contacting the FBI and made arrangements to get a team and two "peacekeepers" on scene by 0700 hrs the next morning. Cavinta stated that as this was taking place, he heard that there was smoke coming from a window in the residence. Cavinta stated he could see the smoke and ordered Sgt. Fridley to continue with surrender orders.

Cavinta described the smoke as a light smoke mix with darker smoke. Cavinta stated it would bellow at times, and then cease at times. Cavinta stated that about 30-40 minutes passed before he visually saw active flame. Cavinta stated there was a lot of smoke on the number four side of the building. Cavinta stated that there was a point when he recognized that the fire was going to increase. The fire was spreading inside. Cavinta stated that he had the command van move, as it was blocking the driveway to the residence. A fire truck was on scene and a second truck was requested. Cavinta stated that at this point, Sgt. Fridley was desperate in his attempts to communicate for [REDACTED] to surrender and remove himself from the building. Cavinta stated that he had the fireman stage on the driveway. Cavinta stated he talked with the fire Chief who was on scene. Cavinta stated that he advised there was an active shooter in the building and there were numerous firearms and ammunition in the building. Cavinta stated that it was unsafe for fire personnel to go into the residence. Cavinta stated that he told fire personnel that when someone was in handcuffs, when the building collapses or there were no longer sounds of ammunition

burning off, he would allow firemen to approach.

Cavinta stated that Lt. Morey was also on scene and near the fire trucks. Cavinta stated that he believes that Lt. Morey was the one that gave the order for the trucks to move up. At that time, the trucks were committed. Cavinta stated that the area was a crime scene, so the areas where the patrol vehicles were parked were marked. This was because the vehicle had to be moved to allow the fire trucks in. Cavinta stated that he learned the fire department had cut a hole in the wall of the structure, on the number one side. It was where the bathroom was located. The fire department was able to look in the hole and see a body on the floor.

Tactical dispatchers recorded the exact times of events as they occurred. These included EPD Dispatcher [REDACTED] and HCSD Dispatcher [REDACTED]. Cavinta stated that during the incident, he had numerous conversations with Under Sheriff Mike Downey and the Sheriff, Gary Philp. Cavinta stated that neither of the two made any alterations during any discussions of the plans he had.

The interview ended at 1319 hrs. This interview was recorded via digital recorder. Refer to typed transcript of interview for exact details, as above narrative is only a brief summary of entire statement. This would include some areas of the interview where Lt. Cavinta explained things in detail, much more than what is noted in this summary.

Interview with Deputy Blake F. Massaro

On June 26, 2007 at 1001 hrs, I assisted Detective Schlesiger with an interview of Deputy Blake Massaro. The interview was conducted at the Sheriff's Office. Massaro stated that he was present during the Hoopa incident and had previously given a recorded statement to Detective Quenell and Officer Eberhardt of the C.I.R.T. team. Detective Schlesiger and I wanted to follow up with some questions, specifically about the deployment of the hand grenades in the residence.

Massaro stated that he was a member of the H.C.S.O. SET team. On the day of the Hoopa incident, he was present as a team member. Massaro stated that as a member of the team, he assisted with the approach of the residence and deployment of the hand thrown grenades. Massaro stated that he was one of two people responsible for holding up a large ballistic blanket. This blanket provided ballistic cover, as members behind the blanket approached the residence. The other member holding the blanket with him was Deputy Brian Taylor.

Massaro stated that the team initially used the 37mm launchers, however, they were not very effective. A decision was made to introduce hand held gas grenades. Massaro stated he was not a gas expert, so he was not sure what exactly was used and or how that decision was made. Massaro stated that as he and the team approached the residence, Deputy Barney threw in the hand held grenades. Massaro describes a mini-debrief about how the first approach went, as a second approach was planned. CDC was a part of this briefing. CDC brought down a raid vest

filled with gas hand grenades. They had discussed what each grenade did. CDC stated that some were incendiary and some were for indoor use. Massaro stated that it was decided that all the incendiary devices be removed as they did not want a fire in the house. He stated that they just wanted to get [REDACTED] out of the house.

Massaro stated that there was a person who appeared to be the team leader for CDC. This person gave information about the grenades. Massaro described the person as wearing a green raid vest and having a thin dark mustache. Massaro stated that the type of gas grenades on the second approach were the same. In addition for the second approach, the also got a "rubberized ball". It was a sting ball grenade, it sends out rubberized pellets with the CS gas when deployed. That was going to be introduced into the window. The ball looked like a black softball. The ball said sting ball on the white paper.

The second approach, two grenades were tossed. The first window was a CS grenade, the second window got the sting ball and a CS grenade. The second CS grenade missed. It bounced on the ground and Sgt. Quenell picked up with a bare hand and through it back into the correct window.

Detective Schlesiger showed Deputy Massaro some photos of the vest that CDC had. Massaro confirmed that it was a similar vest he saw at the scene. Schlesiger also showed Massaro pictures of various hand held grenades. Massaro stated that the sting ball he saw had black lettering, he did not remember seeing any blue lettering. Massaro stated that is was clear that no one wanted any incendiary devices used and they did not want a fire to start.

The interview ended at 1017 hrs. This interview was recorded via digital recorder. Refer to typed transcript of interview for exact details (to be completed by HCSO).

2nd Interview with Jaime Barney

On June 26, 2007 at about 1025 hrs, I assisted Detective Schlesiger with a second interview of Jaime Barney. On the first interview (June 7th), Barney had his Attorney, [REDACTED] present with him. [REDACTED] had previously left me a phone message stating it would be fine to talk with Deputy Barney a second time, knowing he would not be present. Additionally, Barney stated he did not mind giving a second voluntary statement with out [REDACTED] being present.

Detective Schlesiger asked Barney specifically about the transaction that occurred regarding the hand thrown grenades and CDC. Barney stated that there were two approaches to the residence where hand grenades were used. On the first approach, he deployed two aerosol type grenades that were owned by the Sheriff's Department. Barney stated that on the second approach, they used two tri-chamber hand grenades and a Sting Ball. These were owned by CDC.

Barney stated that CDC had a vest containing an array of grenades and sting balls. Barney stated that he actually put the vest on initially. After a discussion with Sgt. Quenell, it was decided that

they did not want any pyrotechnics, so they were removed them from the vest. Barney stated he took the tri-chambers and the sting ball and left the vest off.

Barney stated that he approached the residence again with the team. Barney stated that he threw the tri-chamber into window "A" on the 4 side. Barney then threw the stinger ball into window "B", followed by the tri-chamber. Barney stated that he missed, when throwing the tri-chamber and Sgt. Quenell picked it up and threw it back into window "B". Barney stated that when he threw the Stinger ball, he heard a distinctive "boom".

Barney described the sting ball as a round rubber coated ball. Barney did not remember if there was writing on the ball or not. Det. Schlesiger showed Barney some pictures of a hand ball and a sting ball. Barney stated they looked similar to what was thrown, however, did not remember exactly what one was thrown.

The interview ended at 1043 hrs. This interview was recorded via digital recorder. Refer to typed transcript of interview for exact details (to be completed by HCSO).

Interview with Deputy Jesse A. Taylor

On June 27, 2007 at about 1310 hrs, I assisted Detective Schlesiger with interviewing Deputy Jesse A. Taylor for a second time. Taylor is a member of the Sheriff's Office SET team and was present at the incident in Hoopa. H.C.S.O. Detective Quenell and D.A. Chief Investigator Hislop of the C.I.R.T. team previously interviewed Taylor. Refer to report and transcripts for further.

Detective Schlesiger and I questioned Deputy Taylor specifically about the transaction with CDC and how the Sheriff's Office got the hand held grenades, deployed at the Hoopa residence. Taylor stated that CDC came down to the Deputies location, near the parked patrol vehicle in the driveway. The CDC team leader, or who he thought was the team leader, had an assortment of gas. This would have been after the first deployment of hand grenades owned by the Sheriff's office. The CDC team was willing to let the Sheriff's office use these items on the second approach if needed. Taylor stated that the gas was in a vest. Taylor stated that the CDC leader described each canister and its functions. The CDC team leader and Sgt. Quenell discussed the different types of canisters. Taylor stated he was present when Sgt. Quenell told the CDC team leader that he was not going to use any pyrotechnics. Taylor stated he does not know what was actually taken and what was left behind for the deployment.

Taylor said he was part of the two tactical approaches to the residence when hand gas grenades were used. Taylor stated he assisted with cover. Taylor stated that on the first approach to the house, the grenades used belonged to the Sheriff's Office. The second approach was the CDC's supply. Taylor stated he knew that gas was used during each of the deployments, however, he did not know what specifically was used. Taylor stated that his function was to provide cover and he was paying more attention to the house. Taylor stated he heard a faint popping sound after the

grenades were thrown in the second time. Taylor stated he did not hear any explosions.

Detective Schlesiger showed Taylor some pictures. Taylor was able to identify the vest that CDC had at the scene with the grenades as the same in the photo. Taylor stated that his observations were pretty limited. Taylor stated that the hand ball and stinger ball pictures he looked at are very similar to each other, the shape was similar to what he saw used. Taylor added that he remembers specifically that the CDC guy told Sgt. Quenell that the different gasses used, have different psychological effects on a person. Taylor was not sure what that meant and did not know if that was relevant or not.

The interview ended at 1326 hrs. This interview was recorded via digital recorder. Refer to typed transcript of interview for exact details (to be completed by HCSO).

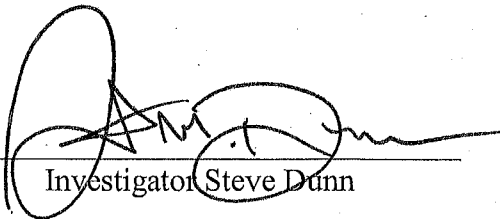

Investigator Steve Dunn

CRIMINAL DIVISION

825 5th Street
Eureka, CA 95501
(707)445-7411
(707) 445-7416 Fax

VICTIM WITNESS ASSISTANCE

712 4th Street
Eureka, CA 95501
(707) 445-7417
(707) 445-7490 Fax

1
2
3
4
5
6
7 **INTERVIEW WITH LT. DAVE MOREY**

8 [REDACTED] Det. Rich Schlesinger

9 [REDACTED] Inv. Steve Dunn

10 [REDACTED] [REDACTED]
11 A:=Lt. Dave Morey

12
13 [REDACTED] Today is June 25, 2007; the time is 144 – 1443 hours. Case 200703162, I'm
14 meeting with uh Lt. Dave Morey at the (unintelligible) command in this
15 office. Uh Det. Schlesinger and Inv. Dunn are also present. Uh Dave what's
16 your middle initial?

17
18 A: M for (Matthew).

19
20 [REDACTED] M-O-R-E-Y and your uh pin number?

21
22 A: Zero six one six.

23
24 [REDACTED] Okay and obviously you know why we're here to talk to you about what
25 transpired in the last two days. You – from what I understand, and from what I
26 know is you weren't there the first day, is that correct?

27
28 A: Correct.

29
30 [REDACTED] Okay how – how did the notification begin and just start from there when you
31 were notified that you were needed.

32
33 A: Okay, it would have been Sunday June 3rd, probably around 430 – 500 I
34 guess in the evening, I didn't check too close to know the time but I was on
35 the way back from a wedding I attended in (Redding). And when I got to
36 (Weaverville) I got cell service and noticed I had missed a call. Uh I ended up
37 returning the phone call and – to dispatch and fund out - or found out –
38 somebody was calling me, I can't remember who, I thing (unintelligible) was
39 calling about, do you know? Or, you know, do you need cover, and stuff like
40 that. So I called dispatch and found out that the – the (SET) Team was being
41 mobilized, that there was a stand-off situation and uh (unintelligible) and the
42 negotiators were looking for negotiators and the best that we could do was get
43 a hold of Dep. (unintelligible) (Daniels) and Sgt. (Mike Frithy) who were on
44 scene, and I explained to them that I was out of the area, but as soon as I got
45 to town, I'd call them. I got back to the house, uh talked to Steve Dunn briefly

46 about what was going on, uh I think at one point I was talking to him on the
47 phone, and he was screaming out that there was shots fired. Um and we lost
48 connection, uh basically my – my involvement on Sunday was about 9 – 9
49 p.m. I was at my office trying to find a negotiator to relieve the morning, uh
50 for Monday the 4th. So what I did is uh in my office here the night of the 3rd,
51 I called uh Sgt. (Dell) Higgerson, H-I-G-G-E-R-S-O-N who works for Pelican
52 Bay State Prison, uh we've worked with him in the past, um and knew that
53 they had a very large negotiation team. But the problem was before I called
54 Higgerson, I made phone calls to my negotiators and I couldn't find any but
55 one, that would be able the next day, so I knew I was in need of some
56 assistance. So I called (Dell) explained to him that uh if he could send a team
57 over, that would be great, and if he could meet me here at six in the morning,
58 on the day of the 4th, that uh I could meet him up there. Uh he said he would
59 make some phone calls and then he called me back within about 45 minutes to
60 an hour, said he had a team, that he's uh meet us here at six in the morning
61 and uh asked that I call if it got cancelled. I was up at four in the morning on
62 the 4th, uh made some phone calls to dispatch, found out that we were still
63 active, so I drove to the station here. Right at 600 in the morning (Dell)
64 Higgerson arrived with his team and he brought with him, I can't remember
65 the exact number, but I know that they all checked in at your command post.
66 So you guys should have all that info, but if I remember correctly there was uh
67 anywhere in the neighborhood of six negotiators. I think they brought three or
68 four of the tactical team with them, and uh, I didn't ask for a tactical team, I
69 just asked for the negotiators, they came of their own free will. Um prior to
70 them being here, I called uh the dispatch, got the quick briefing on the guy's
71 name, and you know, what the status was, gave them a quick briefing. Uh we
72 left out of here, got gas, got up to the command post, (unintelligible) goes,
73 probably around, I say around 740, 745.

74
75 [REDACTED] (Unintelligible).

76
77 A: (Unintelligible), sorry, (unintelligible). Checked in with Det. (Benta) uh
78 explained to him the resources that I brought with me, uh we set up a
79 negotiation center. Uh a potential negotiation center, in case we could actually
80 deliver a phone, in the (SET) trailer. Um they got all their gear out, after
81 talking with Lt. (Kaminsa) uh it was agreed that we would move um two of
82 their negotiators, Pelican Bay's negotiators along with their tactical element
83 for cover, up to the vehicles, uh the Tribal Police vehicles that were below the
84 trailer and attempt to use the bullhorn to uh initiate negotiations with uh the
85 [REDACTED] in the residence. Uh Sgt. (Cornell) from our tactical team led them
86 forward and, I don't have the times on that, but it was logged. Uh in our
87 command van, they then initiated negotiations or attempted to, I know when
88 they came back, I debriefed them and they said they used a bull – their
89 handheld bullhorn and the PA: system from the patrol cars, and I believe they

90 were there trying for about 45 minutes to an hour. Uh they got no response
91 and we brought them back.

92
93 [REDACTED] Okay were those the uh vehicles that had been shot?
94

95 A: My understanding, I didn't go with them Rich, it was my understanding that
96 they moved as far forward as the Tribal Police vehicles that had the windows
97 shot out.

98
99 [REDACTED] Okay.

100
101 A: Is where they were uh trying to negotiate with him from. Um I know that they
102 said they had zero response, nor did they hear any movement in the house.
103 Um when they came back, Lt. (Kaminsa) and I talked a little bit about what
104 some of our options were about the fact that maybe he just passed out or in
105 such a deep sleep that maybe he's not hearing the PA:. Uh talked about maybe
106 making some more noise, and then uh from there, I don't think Pelican Bay
107 went back up again. I think where we went from there was uh Sgt. (Frithy)
108 moved forward to uh issue surrender commands, once the decision was made
109 to start introducing gas. And (unintelligible) at that point, uh I waited around,
110 the conversation between (Kaminsa) and I was that we would maintain a
111 negotiating staff there just in the even that the guy had a change of heart
112 during the gas and he wanted to engage in conversation with us for a surrender
113 or whatever his problems were, that they would be there to assist us. But I
114 think that's pretty much it for me.

115
116 A: Okay.

117
118 [REDACTED] You were on the SWA:T team right?
119

120 A: Affirmative.

121
122 [REDACTED] Uh how -- how long were you on the SWA:T team?
123

124 A: Eleven years.

125
126 [REDACTED] When you were meeting with Lt. (Kaminsa) um were you assisting in making
127 decisions tactically at what was going to go on next?
128

129 A: No.

130
131 [REDACTED] Okay. Do you have any idea of approximate time of the whole time, you guys
132 arrived and set up the negotiations, um how long did, I'm going to call it your
133 team since you were technically they had someone in charge, but you were
134 overseeing their team, pretty much as far as what they were going to do.

135
136 A: When you say their team, you talking about Pelican Bay?
137
138 [REDACTED] Pelican Bay.
139
140 A: Yeah all the negotiations aspect is my charge.
141
142 [REDACTED] Okay. Um I forgot what I was going to say. How long would you say in hours
143 or that, were they there actually negotiating, trying to negotiate with [REDACTED]
144 [REDACTED]
145
146 A: I don't think there -- I don't think you can say we were ever trying to negotiate
147 with him. We were trying to get him to come to the window, to talk to us so
148 we could enter negotiations. I think every -- every phase that I was involved
149 in, whether it be Pelican Bay team or when (Frithy) went forward to make the
150 surrender commands, was all just a plea for him to come to a position to talk
151 to us. Um we never even -- I can't say that we ever got into a negotiations
152 phase, ever, while I was there.
153
154 [REDACTED] You know, you weren't down with the -- the Pelican Bay crew, but were they
155 in the, I know a little bit about stuff of negotiating that when you've got an
156 active shooter, they somewhat use a they go to like a surrender mode they call
157 it.
158
159 A: Mm -- hm.
160
161 [REDACTED] A:nd you were a negotiator right? Tell them where you negotiated with.
162
163 A: I'm still on the negotiations team. Uh five years maybe -- maybe longer.
164
165 [REDACTED] Okay, so you're familiar with what I'm talking about?
166
167 A: Yeah.
168
169 [REDACTED] Were those guys that were down there from the Pelican Bay, were they doing
170 more of the surrender thing, or were they in still trying to hey, talk to us and
171 do whatever?
172
173 A: Okay, they -- Pelican Bay never got sent to the surrender phase. Pelican Bay,
174 all they ever did was the attempt to establish negotiations. Uh their -- their -- in
175 debriefing them, it was my understanding in talking to them, theirs was a plea
176 of, can you come to the window, can you talk to us, are you okay, uh come to
177 the window, can you talk to us? That was all an attempt at negotiations. Now
178 when (Frithy) moved forward, Sgt. (Frithy) moved forward later when they
179 were going to do the gas introduction, um that I believe came more of your

180 surrender phase because I really didn't have any control per say over Sgt.
181 (Frithy) at that time. I was in the – I was in the command van at that time and
182 Det. (unintelligible) was the one who was providing directions and
183 instructions to Sgt. (Frithy) as to when to sound the siren, when to make the
184 surrender commands, things like that. Uh so there really – it really wasn't, in
185 my mind, Sgt. (Frithy) wasn't in the negotiation phase, he was in the surrender
186 phase. And um it's my understanding that he was at the patrol cars, uh
187 forward, the ones that were shot at, or in that general vicinity, using the PA:
188 system and sirens to try to alert, awake, or get him to acknowledge that we
189 were in a surrender phase.

190
191 [REDACTED] Okay and it, obviously you're in charge of (unintelligible), but is that unusual
192 for someone of tactical – whose tactical, in charge tactically, to maybe take
193 over and advise your negotiator of what needs to be done next?

194
195 A: No, it wouldn't be unusual, I mean, because truly, at tat point we're, his role
196 wouldn't be that of a negotiator. Uh his um the training aspect as far as issuing
197 a surrender command and negotiating are worlds apart. I, you know, you can –
198 you can send anybody forward to the surrender phase with a notebook paper
199 that says just keep saying this; come out with your hands up, come to my
200 voice. And that's all that (Mike) was really doing at that point.

201
202 [REDACTED] Okay. Yeah a couple questions, um when you came back from (Redding) on
203 your way back here, you at some point you said that your – you were assigned
204 to contact some additional negotiators, who do you communicate that with? I
205 mean who's – who are you talking to uh in regards to your role, what you're
206 going to assist with?

207
208 A: Um it was uh, you know what, I hate to sound wishy-washy but, you know, I
209 was beat tired from driving all day and I – and I remember talking to (Knight)
210 several times on the cell phone and pretty much what they were asking for
211 was um uh another – there was another operational period, and they were
212 looking for negotiators for the next operational period. So the request came
213 from (Knight), I'm fairly certain, he was the duty officer for the weekend.
214 Asking for me to try to find uh a replacement for the morning.

215
216 [REDACTED] Okay. How does that work with...?

217
218 A: But I did call – and let me back up too. Um after that I phoned the under
219 sheriff and I explained again, I said look, I - I can't find negotiators from our
220 team, I'm going to make a mutual aid request to Pelican Bay, and some
221 authority to make that phone call, and he said "Yeah, go ahead and call them."
222 So the under sheriff told me he gave me the authority to call out Pelican Bay.

224 [REDACTED] And how does that work with you being the Lieutenant and (Kaminsa) being
225 the Lieutenant on a detail like this on strategic stuff. (Kaminsa)'s in charge of
226 certain areas and then I heard you're -- you said that you're in charge of an
227 aspect of your role as negotiators?
228

229 A: Right. Um Lt. (Kaminsa) would be strictly in charge of the tactical team, I
230 would be in charge of the negotiating team, and he is going to look for my
231 input, um as to what, you know, should we wait or how well are you doing,
232 and are we -- are we gaining ground with the negotiations, things like that.
233 Ultimately he would get -- he would communicate with the under sheriff for
234 whatever tactics he was going to employ, I would assume, I don't -- I don't
235 know who he -- who he was reporting to or (George) was given the authority
236 by the under sheriff to make these decisions independently (unintelligible) or
237 what to do, so and I can't answer to that but really I had nothing for Lt.
238 (Kaminsa) and I couldn't tell him the negotiations were being successful
239 because we never negotiated. But I can tell you when I got there that the plan
240 was that they uh wanted to make every attempt they could to make sure that
241 we tried to get him to come to the window and at least start negotiations
242 before they went tactical. And that's what my instructions were when we got
243 there, was let's try again, let's see if we can't get him before we do anything
244 tactically.
245

246 [REDACTED] Mm -- hm. And once you were up there, Pelican Bay's team's up there,
247 (unintelligible)'s a negotiator?
248

249 A: He is, he's on the negotiating team.
250

251 [REDACTED] And so are you in communications with him directly or are you working
252 through Lt. (Kaminsa)?
253

254 A: Um the decision to send Sgt. (Frithy) to do the surrender phase was decided
255 by Lt. (Kaminsa). Um as far as I was concerned, uh Sgt. (Frithy) was working
256 his regular shift and I hadn't called Sgt. (Frithy) as part of my relief element
257 for that day, and Lt. (Kaminsa) just commandeered Sgt. (Frithy) and assigned
258 him to go up to make the surrender commands.
259

260 [REDACTED] Okay. One more question, how long have you been employed with us?
261

262 A: Uh about 22 years.
263

264 [REDACTED] Do you have anything else?
265

266 [REDACTED] Dave is there anything that we haven't asked you about the incident and the
267 day you were up there, uh June 24th, that we should know?
268

269 A: No.

270

271 [REDACTED] Okay, we'll end the interview at 1500 hours.

272

273

274 This transcript has been reviewed with the audio recording submitted and is an accurate
275 transcription.

276

Signed _____

INTERVIEW WITH LT. STEVE KNIGHT

Q= [REDACTED]

Q1= [REDACTED]

Q2= [REDACTED]

A=Lt. Steve Knight

1
2
3
4
5
6
7
8
9
10
11
12
13
14
15
16
17
18
19
20
21
22
23
24
25
26
27
28
29
30
31
32
33
34
35
36
37
38
39
40
41
42
43
44
45

A: Uh there was (unintelligible).

Q: And your PIN number?

A: 0530.

Q: Steve how long have you been employed by the (unintelligible)?

A: Twenty-one years.

Q: Okay and you're currently you're obviously a lieutenant?

A: Yes.

Q: Okay. And you're currently in charge of uh animal shelter?

A: And the airport.

Q: And the airport okay. Uh from my understanding you were the on call duty officer this last weekend?

A: Yes.

Q: Okay. Why don't we just start from you getting the call and go from there?

A: Okay I received a call on Sunday, which would been June 3rd, about 3:30 in the afternoon. I was at home. Um from a dispatcher [REDACTED] who told me, said, "Lieutenant I want to make you aware of a situation that's unfolding uh since you're the on call uh regarding uh-uh [REDACTED] up in (Hoopah), who had brandished a rifle at uh Officer (Barry)." She said that uh Sergeant (Miller) and other units were in route. She said the gentleman's name was uh [REDACTED]

46
47 Q: [REDACTED]
48
49 A: [REDACTED] yes. Um had recently been released from [REDACTED] uh on
50 Friday. She said he was uh had been uh-uh known to be violent and
51 apparently Deputy (Barry) and Officer (Landernow) here at tribal had gone up
52 there to do a welfare check. She said when they went up there to do a welfare
53 check uh-uh [REDACTED] had come out and uh pointed a rifle on
54 them and they were called for assistance. Uh she said that there were uh other
55 witnesses, apparently, that were in the area too. I asked for who the sergeant
56 was and it was Sergeant (Miller). So I called Sergeant (Miller) on his cell
57 phone, said, "What's going on?" And Sergeant (Miller) then told me that he
58 was responding up there, that uh Deputy (Barry) had uh [REDACTED] was
59 pointing a rifle uh at him and um Officer (Landernow) kind of reaffirmed
60 what dispatch told me. And uh I believe - I asked him some questions about,
61 besides the officer is anybody else in danger? What can you tell me about it?
62 He said there was some residents in the immediate area. Um at some point in
63 the conversation it was brought up that there was a 90-year-old man that was
64 living in the house close by. He felt that um it was definitely a hazard to
65 neighbors. It was like a compound is the way he described this area. And that
66 um, he said, "My recommendation Lieutenant, is we get a special enforcement
67 call out to respond to this with what's going on." Um he said that uh it was a
68 pretty serious situation. Um no shots had been fired at that point. So I called
69 the sherriff uh and advised the sheriff what was going on that we had officers
70 that had a rifle pointed at them. And kind of relayed all the information I
71 received between dispatch uh with Officer [REDACTED] telling me—
72 (unintelligible) Dispatcher [REDACTED] and uh Sergeant (Miller).
73 And that we had officers still on seen and uh the recommendation that we -we
74 look at sending the special enforcement team with what was going on. And
75 we had at least a crime of-of brandishing a weapon at a police officer,
76 possibly assault with a deadly weapon. And uh-uh with the (unintelligible) to
77 go ahead and get the special enforcement team responding.
78
79 Q: You (unintelligible) or the under sheriff?
80
81 A: The sheriff.
82
83 Q: Okay.
84
85 A: I tried calling the under sheriff and could not get to him because he was down
86 in (unintelligible).
87
88 Q: Okay.
89

90 A: So after that, I called dispatch back. Spoke with dispatch, um, told him go
91 ahead and call out special enforcement teams. Um I called Lieutenant
92 (Kiventa) who's in charge of special enforcement teams, said this is what I
93 understand of the situation. Um that Deputy (Barry)'s up there and has a call
94 for emergency back up. I said that uh there are other people that are uh in
95 danger, that we have a [REDACTED] with a rifle. That he may or may not have
96 ammunition was one thing that was brought up. We didn't know but we had
97 to assume that he did at this point until we found out for sure otherwise. That
98 he had no health issues, and um and could be violent-had been. Um and he
99 said he would be responding. Um I told him I would uh be responding to the
100 office and also help him out (unintelligible) so that he didn't have to go
101 himself, see what I could do to assist.
102

103 Q: So did (Kiventa) tell you that he was going to call his-officers or deputies
104 at that time?
105

106 A: The special enforcement team?
107

108 Q: Yeah.
109

110 A: No. It-it was already started.
111

112 Q: It was already started?
113

114 A: Yeah he concurred. He understood.
115

116 Q: Okay.
117

118 A: Yeah. We talked about it and he felt that was-at that point he was okay with
119 the decision to.
120

121 Q: Okay.
122

123 A: Um and the sheriff had also authorized it.
124

125 Q: Okay.
126

127 A: Um as we were-sometime during this and going to the or-I-I drove to the
128 office, met with the officer that the office, there was a point I remember
129 hearing on the radio that he was back on the-he was on the porch, he
130 (unintelligible) inside at one point. The question I asked too, was there
131 anybody in the house that was in danger? Was he by himself? Uh the
132 proximity of other residences, roadways, et cetera? And it was uh relayed that
133 there was a danger to the residences which when I got up there later it was
134 obvious. And uh so when I was responding to the office, I believe was when

135 it happened. The time frame there that he came back out, I heard on the radio,
136 was back out on the porch with a rifle. Um and Officer (Barry) was – (Greg
137 Barry) was relaying this over the radio. Um I got to the office and apparently
138 (Barry) was hiding behind his car or something. He was trying to stay out of
139 harm's way. Uh talked briefly with the special enforcement team, Sergeant
140 (Klunel) and members as they were showing up uh and got whatever
141 information I could on him. As far as I got (unintelligible) report we were at
142 with the situation uh from dispatch. Got uh-uh a printout that was uh handed
143 to me that was already – somebody had already made a copy of his booking
144 photo from previous bookings so we had that information so we knew what
145 we were going to go up there and be dealing with. Uh one of the things too, I
146 forget to bring up when I talked to (Kiventa) on the special enforcement team
147 issue, I also asked dispatch for hostage negotiators. Um I tried calling
148 Lieutenant (Moren) who is actually in charge of the hostage negotiators and
149 couldn't get through to him. So if he was going to go with Lieutenant
150 (Kiventa) then I was probably going to stay out of it because there would have
151 been those two, would have gone up to, you know would have been enough.
152 But because he was unavailable, couldn't get through to him, had dispatch
153 keep trying to get a hold of him for me. Um and since I'd had some
154 background dealing with hostage negotiators that's why, another reason why I
155 went up there. So it turned out Lieutenant (Moren) was out of town. Um in
156 fact we passed each other on 299 so um after I briefed the SWAT team, what
157 little I knew, uh explaining what was going on. Um they all responded, the
158 special enforcement team responded up there and hostage negotiators uh I was
159 told by dispatch, Lieutenant (Daniels) would be going up to the scene.

160
161 Q1: Okay. And um after you guys meet at the sheriff's office do-do you respond
162 up to the scene also?

163
164 A: Yes.

165
166 Q1: Okay.

167
168 A: Go ahead and go from when you arrive.

169
170 A: Just-just part of what I remember, I remember getting off the whole Loop
171 Road and starting off on Pine Creek radio. I heard on the radio the
172 (unintelligible) Sergeant (Klunel), (Brian Klunel) saying he just shot at us. So
173 that kind of took care of the problem of whether or not he had ammunition.
174 And uh they needed Deputy (Fulton) to expedite his response because he was
175 bringing up the special enforcement team trailer. So when I arrived at the
176 scene, um I was one of the last ones to get there. Uh the Lieutenant (Kiventa)
177 was supposed to have gotten there some time ahead of me. The special
178 enforcement team was already taking up positions at the meeting with
179 Lieutenant (Kiventa) who was trying to contain the scene. [REDACTED] was

180 still in his house to that-at that point from what I understood. Um and uh they
181 con-ried to contain it. We were trying to work at making sure what we kid
182 was still fluid too, as far as who was in harms way, the residences who was
183 there. You were - I think you got there a few minutes before I did. And uh
184 talking to Lieutenant (Kiventa) starting to set up a plan on how to deal with it.
185 Um the decision was made obviously once everybody was set up on perimeter
186 was to try to talk to him and see if we could get him to come out an talk to us.
187 Uh and so Sergeant (Frinsley) and (Daniels) uh I talked to them and they said
188 uh to see what you can—first question I asked (Kiventa) was do we have any
189 um ways to communicate, phone? Is there a way to get an extra
190 communication to the residence uh and because of his shots being fired the-
191 the throw phone idea wasn't going to work because we were worried about
192 getting somebody killed or hurt. So second thought, you know, there was no
193 phone in the house we were told. Um and uh I believe you actually told me
194 that, Detective Schlesiger told me that information. There was no phone in
195 the house. Um, so then we decided the only thing we had to use was a public
196 address system out of our patrol control.

197
198 Q: Just ...

199
200 A: Go ahead.

201
202 Q: You can remember — I think-I believe the first shots was around 18:28 or
203 something like that.

204
205 A: Yeah I wasn't quite there yet.

206
207 Q: Do you know when about negotiations starts?

208
209 A: I don't believe that-as I remember the negotiations started about the time I got
210 there, and this is why I know that because when I got that and that was
211 (Frinsley) and (Daniels) uh they-they have done something before I got there.
212 But when I (unintelligible) I asked them, I said do you have a tape recorder
213 and they said no and I said get one. I said let's get a tape recorder up there. I
214 want you to tape the negotiations too when you're talking. We're trying to
215 tape the phone conversations and stuff. And (Mike) said I think have one.
216 And I said if you don't have any Rich, Detective Schlesiger does because I
217 just saw him using it talking to the family. So I asked him, I said to find a
218 tape recorder. I want you to tape when we try to talk to him um as this thing
219 is progressing so we have it recorded somehow.

220
221 Q: And uh so what went on next then?

222

- 223 A: They-they (Frinsley) and (Daniels) went up, I don't remember where they
224 went but as close as they could get and be reasonably safe. I remember they
225 were wearing helmets and vests and everything else.
226
- 227 Q: Where-where'd they go up to?
228
- 229 A: They um good question. They went up to-in one of the patrol cars closest to
230 the residence.
231
- 232 Q: Was it one of the vehicles that had been shot to your knowledge?
233
- 234 A: I don't know. I know by the time I got there Lieutenant (Kiventa) was
235 debriefing me as to where things were at he said that two (unintelligible) I
236 believe it was said two patrol cars had been shot. There was three shots fired
237 and apparently (unintelligible) (Taylor) fired one round back, one of our
238 deputies. Um it had come out of the window and uh uh the damage it was t-
239 tribal cars, I want to say (Hoopla) tribal cars or maybe (unintelligible) tribal
240 cars was struck by the bullets. And they, I don't know which, they were in
241 one of the front two cars if I'm not mistaken, trying to be in a safe location
242 while at the same time trying to communicate.
243
- 244 Q: Okay.
245
- 246 A: So um I remember calling the sheriff and explaining to him that we'd now
247 been-when I was going up the hillside, I was required on scene after the
248 rounds have been fired. And explaining to him that now we've had shots fired
249 to making sure he was in the loop sort of speak about that and that the
250 situation was not good. Um and uh after Lieutenant (Kiventa) with uh I talked
251 with him for a while about negotiations and uh we were trying to do what we
252 could to see if we could get [REDACTED] from the residence and talk to him
253 like that. What happened was (Frinsley) and (Daniels) would come back
254 every 15 minutes or so and I've had communication. They said they were
255 getting no-no statement every made besides yelling. Uh when it's - uh when
256 they asked him to come out, I understand that it was that he said come on and
257 get some or something, come get some, something to that effect. That
258 negotiations were not happening. He was not trying to talk with the officers at
259 all. They would ask him, come out and this case wasn't-wasn't going
260 anywhere and it should all be recorded on the tape.
261
- 262 Q: Okay. Um as the night went on did anything else happen?
263
- 264 A: Yeah. Yes. Um we uh - one of the things we did was I contacted [REDACTED]
265 [REDACTED] uh tried to get more information from them about him. I learned that
266 he'd been just released [REDACTED] on Friday uh the 1st and that
267 apparently he [REDACTED] uh that weekend before that he had

268 torn up [REDACTED] where he was at there, he vandalized that facility in
269 [REDACTED] to the point where they had the Eureka police come to arrest
270 him, take him to jail. Uh apparently he was in jail for a period of time, not
271 very long, [REDACTED] and then was released from [REDACTED]
272 [REDACTED]. Um I had requested some of their workers come up – uh to the scene
273 to see if they could help us out with any advice or negotiations or otherwise.
274 And they said no problem, (unintelligible) back there and everything that's
275 going on. And uh [REDACTED] and (unintelligible), uh let me see, right
276 here somewhere, uh [REDACTED] and [REDACTED] and that was about
277 7:25 uh when they I talked to them and said they would be en route from
278 (Fortuna). And I actually spoke to the [REDACTED] around uh 5:20 or not
279 5:20 – about 7:20 or so. They called me back pretty quick. Um and then they
280 drove straight up. And (unintelligible), yep, it should be in the records when
281 they got there.
282

283 Q: Okay.

284
285 A: Um and while we were about two minutes before 9:00 pm I was talking to
286 Lieutenant (Kiventa), (unintelligible) because his SUV, Ford Expedition was
287 behind kind of a burn hillside area and ...
288

289 Q1: How far back Steve was that back from those cars that they were negotiating
290 in?
291

292 A: Maybe three, four cars. It didn't seem like it was that far.
293

294 Q1: How many feet would you say? Or yards?
295

296 A: Twenty-five maybe.
297

298 Q1: Okay.
299

300 A: If that, um, uh was talking to Lieutenant (Kiventa) and strategizing where
301 we're going to go. And also by then I – we got a hold of Under Sheriff
302 (Downey) finally just before or right after that because the next significant
303 event was when uh I was talking to him and we heard a-a snapping buzzing
304 sound. Which at that point uh Lieutenant (Kiventa) said, "What was that?"
305 And they said, "We just got shot at." And then we heard additional obvious
306 gun shots right after that, which Lieutenant (Kiventa) we were both by that
307 point we were ducking down. We thought we were in a pretty safe spot. But
308 uh we weren't sure who's firing. One-the-the shot we heard was uh when the-
309 the rounds I'll say went by us, when I heard the snapping, buzzing sound go
310 by us I never head a shot. It was just a quick crack and from-from the round
311 actually, well I never heard actually the firing of a muzzle or anything like
312 that. And then I heard the obvious firing of weapons that were much louder.

313 And um at that point we asked what happened they said he just shot at uh --
314 the officer shot at the window. And uh ...

315
316 Q: You (unintelligible) the [REDACTED] shot out ...

317
318 A: The [REDACTED] shot out the win-out a window of the residence and he um the
319 special enforcement team in responding returned fire back at the window
320 where the [REDACTED] shot.

321
322 Q1: Do you recall how many rounds of -- or gunshots you actually heard,
323 approximately?

324
325 A: In total around six.

326
327 Q1: Okay.

328
329 A: Five or six.

330
331 Q1: Okay.

332
333 A: And then uh I remember Lieutenant (Kiventa) going and asked the special
334 enforcement team, what was going on and they -- that's when they said you
335 know he'd shot out the window and there -- some of the officers had returned
336 fire. And at roll call everybody was okay. He said the officers, um, the
337 special enforcement team thought that this [REDACTED] was still moving around or
338 something along those lines. So then uh no indication, it was that -- you know
339 it was that he was still moving around uh the house. Uh Sergeant (Klunel)
340 told us uh that he thought he'd fired at him and that it appears from what I'm
341 hearing after the fact that maybe he (unintelligible) where we at. That maybe
342 we -- what actually happened to us was a ricochet that went right by us. We--
343 when I was on the SWAT team years ago, when (Cobine) was in charge of it I
344 believe he was in lieutenant then, they have us on the range, go down range
345 and they shot over our heads so we know what that sounded like. And it paid
346 off because uh it was the first time I ever heard a round other than that go over
347 my head and it was obvious that's what it was.

348
349 Q: Okay.

350
351 A: So um one of the things I was doing while uh Lieutenant (Kiventa) was trying
352 to work with the special enforcement team and (unintelligible) track of them.
353 I was trying to keep communication with the hostage negotiators, which
354 negotiations wasn't seeming to going to work. It was a one way straight. Um,
355 he was communicating with us, Sergeant (Frinsley) would come back and say
356 nothing. I mean there was yelling, and that was just sporadic, but he said that
357 he was not talking to them in any way, shape, or form, other than that one

358 statement. Um so I called uh Lieutenant (Moren) about it was about 9:30 or
359 so if I'm not mistaken, sometime in there and spoke to him about the next day
360 and getting relief and getting more hostage negotiators up there and continue
361 the next day. He said that he would work on it – um to get more hostage
362 negotiators. And then I also made a phone to call to Eureka Police at uh
363 Lieutenant (Kiventa)'s request to get a Sergeant (Melborn) on the line to start
364 working uh relief for our folks who—because it looked like it was going to be
365 there for a while. The way things were going, to see if we could get relief so
366 our guys could get a break. Uh so that was – (Melborn) called back a short
367 time later said he would be calling us back and bring some more of the – some
368 of his team members in to relieve our team members and-and also as we
369 requested more hostage negotiators. And he said he would bring two more
370 up, some-some members of his team to give our hostage negotiators a break
371 also. Um so then about, I'm trying to think of what time it got dark around,
372 10:00 or so. Once again, nothing was working, no contact, nothing. Um I
373 talked to Sergeant (Frinsley) and Sergeant (Frinsley) and (Kiventa) they talked
374 some and it was determined that the negotiators were going to quit talking on
375 the PA system because it wasn't getting anywhere. If it would try to talk to
376 the officers and they would obviously engage him verbally and see if they
377 could get him to surrender. But because it was no black, you know, dark out
378 there they felt that they were just going to wait. Um so I stayed around with
379 Lieutenant (Kiventa) until around 1:00 in the AM. By then we made sure that
380 the houses nearby were – uh Detective Schlesiger made sure the houses
381 nearby were evacuated. The one round that went by, (unintelligible), that
382 went right over the one house that was right below us. Which uh reaffirmed
383 that we had to get those folks out of there. Um oh one of the things too,
384 during this, like I said this was happening fast, and I didn't realize it, I'd been
385 there almost 45 minutes. That um Deputy (Barry) actually had the
386 homeowner of the house with him on the back side of the house and they were
387 pinned down (unintelligible). And I didn't realize that, that there was a still a
388 civilian that was actually in the perimeter, if I'm not mistaken. And I talked
389 to Lieutenant (Kiventa) about that and I said we got to get the guy out of
390 there. We don't want to get him hurt. He said, "I'm trying." But with the
391 active shooting it was safer for him where he was at. So what Lieutenant
392 (Kiventa) did do was he got a hold of Sergeant (Klunel) they were working on
393 it and apparently they got a group to go back over where (Barry) was at and
394 get him and (Landernow) and the civilian out. And uh I saw (Barry) later on
395 that uh evening when he did get out and the civilian he just went straight up
396 the hill, (unintelligible) heavy brush on his own um and got out a different
397 direction.

398

399 Q1:

400

401

402

Okay. Obviously the command – I don't remember when the-off the top of
my head – the command post or command man arrived. How-before that how
was your or Lieutenant K-(Kiventa) uh communicating with the negotiators or
the uh – the set team?

403
404 A: I was communicating with the negotiators verbally and they would come back
405 and forth and talk to us.
406
407 Q1: Okay.
408
409 A: Um.
410
411 Q1: Did you have a hand held with you?
412
413 A: No they- they -- I haven't had a hand held for some time. So I was listening to
414 the radio with Lieutenant (Kiventa) and then uh you know ...
415
416 Q1: At his rid?
417
418 A: Yes. Yes.
419
420 Q1: Okay.
421
422 A: And he had a portable with him.
423
424 Q1: Okay.
425
426 A: So I'm listening to his radio.
427
428 Q1: Okay.
429
430 A: And then when uh the negotiators would come back and started talk to me
431 some more, Sergeant (Frinsley) would brief me kind of where they were at
432 and what was going on then.
433
434 Q1: Okay and so Steve when you went up there um what was your role um in the-
435 in the whole thing? As far as were you assisting Lieutenant (Kiventa)?
436
437 A: I was at the time trying to be responsible with the hostage negotiators on the
438 negotiation side, um, to assist with them and logistics to help Lieutenant
439 (Kiventa). Lieutenant (Kiventa) was in charge of the special enforcement
440 team and I was trying to do um logistics. Talk to him whenever I could,
441 because that was a lot for one person to try to supervise.
442
443 Q1: As far as like getting information or like whatever the negotiations. So kind
444 of like you became the spokesman for the negotiators and then you pass it on
445 to ...
446
447 A: Yes. Yes, to Lieutenant (Kiventa) as it (unintelligible).

448

449 Q1: And you've been a negotiator before?

450

451 A: No I've been to the command school for negotiators though.

452

453 Q1: You've been on the SWAT team before, right?

454

455 A: Yes.

456

457 Q1: How long were you on the SWAT team?

458

459 A: Off and on like ten years there was a couple short breaks.

460

461 Q1: And obviously I worked for you before so you also have a familiarity with the
462 SERT team and how that operates?

463

464 A: Yes.

465

466 Q1: Okay. Um when you guys were up – I mean when you were calling the
467 sheriff or the under sheriff um what-what was going on with those
468 conversations?

469

470 A: Briefing them where we were at. Um, how it was going. Um I called him
471 again after the second time we were shot at. Um I told him the sheriff was
472 actually the one who brought up the idea of getting a little help up there. And
473 he thought that was a good – I agreed once he said that was a good idea. I
474 mean we had some dispatch that had some phone conversations. So and that
475 was – that was one of his thoughts. I know Lieutenant (Kiventa) talked to
476 Sheriff quite a bit on the phone too. Um then when I was – I talked to
477 Lieutenant (Downy) briefed him and his-one of his concerns was that we had
478 uh you know just making sure that things going okay and that uh the rest of
479 the agency was still functioning to- to keep an eye out for relief, for people
480 who were um, you know were, patrol function, things like that. And that was
481 one of the things I was working on too was if somebody was up there that um
482 – you know like uh, we didn't have anybody working in the (unintelligible).
483 No (unintelligible).

484

485 Q1: Sure.

486

487 A: So (unintelligible) was standing, I believe at the beginning at the gate. And
488 we didn't (unintelligible) so I said, "Hey we've got to still have somebody
489 down there to answer calls for service in the (unintelligible) valley area. And
490 if you've got nothing else going on after you talk to Detective Schlesiger, if
491 you have nothing to add, then get back to work down there. Because there

492 will still be people needing our services." And at that point we had enough
493 people taking care of that problem. So um ...

494
495 Q1: When-when you guys were talking with the sheriff and under sheriff were
496 they make-were you guys running by decisions and what to do next or was it
497 mainly just updates?

498
499 A: I was updating them.

500
501 Q1: Okay and what about Lieutenant (Kiventa)?

502
503 A: Uh I -- you know, he just really talked to the sheriff about where we were at.
504 And that you know, the-the biggest thing we were trying to do is just sit this
505 guy out. I hoped too that he would just sober up from what -- if he was under
506 the influence. Sometimes if you give them time that'll be the big difference
507 (unintelligible) sheriff.

508
509 Q1: You-you talked to [REDACTED] a little. Did they uh give you any idea of
510 what type of person [REDACTED] was or anything like that?

511
512 A: Yeah they said he was the words they used [REDACTED]. And I
513 believe it was [REDACTED] that told me she was surprised that he was
514 released.

515
516 Q1: Okay was there any-did you ever hear anything throughout the night about
517 [REDACTED] or anything like that?

518
519 A: Yeah they said that um ...

520
521 Q1: Who's they?

522
523 A: [REDACTED]

524
525 Q1: Okay.

526
527 A: That was one of the things we were trying to find out whether or not he had
528 ingested any or what that would do if he had a history. Uh one of the [REDACTED]
529 [REDACTED], um, I know-I know (unintelligible) was with [REDACTED] because
530 she was more familiar with the (unintelligible). And I'm hoping I'm not
531 getting them mixed up, made a comment that he [REDACTED]
532 and if he [REDACTED] that would negate any-any [REDACTED]
533 [REDACTED] and that would be a significant
534 problem. But actually they-they kind of educated me that [REDACTED]
535 [REDACTED] they said even marijuana and I didn't realize this uh would [REDACTED]
536 [REDACTED].

537
538 Q: Okay. Steve?
539
540 Q2: A couple things here, um going back to when you first got contacted. And at
541 some point in time you said you went up to the office?
542
543 A: Yes.
544
545 Q2: And that you were informed [REDACTED]?
546
547 A: Yes.
548
549 Q2: Who informed you and what did they inform you of?
550
551 A: Dispatch. They were the ones who said he [REDACTED].
552
553 Q2: Is that from?
554
555 A: [REDACTED] I've got the CAD logs too.
556
557 Q2: So the sheriff's department had had prior calls on him?
558
559 A: Not that I'm aware of but I think (Gregory) was aware of this guy. But it was
560 more of somehow they found out, somebody found out that he had been
561 [REDACTED]
562
563 Q1: I believe that came from tribal.
564
565 A: Yeah because the original call, that's-you're right, because the original call
566 was a welfare check request through tribal because they had no one available
567 to do it. And that's why (Barry) and (Landernow) went up there on this
568 welfare check um as a favor to tribal because they had nobody available to do
569 it. Because (Landernow) is actually with (unintelligible) and they're on the
570 (Hoopa) Reservation.
571
572 Q2: Okay you said that-that (Moren) was unavailable initially and is his role the
573 negotiation supervisor?
574
575 A: Yeah he's in charge of the hostage negotiators.
576
577 Q2: So when you realized that uh for a period of time because he was out of town,
578 he's unavailable and you respond, so that-that would imply that you're
579 probably in charge of negotiations.
580
581 A: Yeah.

582
583 Q2: And you're working with (Kiventa).
584
585 A: Mm-hm.
586
587 Q2: On a plan.
588
589 A: Yeah.
590
591 Q2: Do you always tape record your negotiations?
592
593 A: Uh yes, try to.
594
595 Q2: At some point in time you made the statement you contacted uh [REDACTED]
596 to see if somebody would respond. Do you remember who that was you
597 talked to? Whether it is one of the two people who came out or was that
598 somebody else?
599
600 A: Maybe it was somebody else who said – it could have been actually [REDACTED]
601 [REDACTED] I believe is her name.
602
603 Q2: Okay.
604
605 A: And then they called and said they were going to send two of them up there
606 which kind of surprised me. Uh I believe it was [REDACTED] that I originally
607 spoke with. But I talked to somebody at [REDACTED] and uh and they said
608 they'd be sending two up (unintelligible). As a matter of fact I made a
609 comment, okay, I said be alert too this guy has been shooting at us so be
610 careful. And they said no we understand and we'll still come up which I
611 thought was great.
612
613 Q2: You're not sure if that's [REDACTED] or not, it just could have been that you
614 initially talked with?
615
616 A: Somebody I talked to in [REDACTED]. They called me actually. I think that if I'm
617 not mistaken, I know you can understand guys there's a lot going on. It may
618 have been when I went through dispatch and dispatch called, called me on my
619 cell phone.
620
621 Q2: Did you work with one dispatcher initially? Was it Dispatcher [REDACTED]?
622
623 A: [REDACTED] was the one that initially I talked to.
624
625 Q2: Who was the other dispatcher working do you know?
626

627 A: I don't know.
628
629 Q2: And then going back to once you're actually on the scene, you're working a
630 plan for negotiations at some point in time and you talk about the shots being
631 fired and you were near the vehicles. Who was with you at that time?
632
633 A: (Kiventa) and also we had [REDACTED] came up um.
634 [REDACTED] um had been to tactical negotiations school if I'm not mistaken, and
635 [REDACTED] had been also to some - some sort of related to that, tactical dispatching.
636 And they came up actually to keep log sheets of everything that was
637 happening to assist with uh speaking on the radio when-when Lieutenant
638 (Kiventa) wasn't to help keep track of things. That's one of the things that we
639 were trying to do was logs events-events as they happen.
640
641 Q2: Mm-hm.
642
643 A: To keep track of all that.
644
645 Q2: At some point obviously Lieutenant (Moren) was contacted?
646
647 A: Yes.
648
649 Q2: Once he arrives on scene does he take over all the negotiation stuff?
650
651 A: Uh yeah he would once he got there.
652
653 Q: So I have to go off of that maybe a little Steve, obviously you were familiar
654 with this, you were there the first day, right? And were you not there the
655 second day?
656
657 A: Well Under Sheriff (Downy) told me not to stay there any longer if-if-if if I
658 wasn't needed or if people weren't need to try to not stay there any longer
659 than I absolutely had too. You know if I was needed obviously I would stay
660 there, so um.
661
662 Q: So why didn't you come back the next did, did?
663
664 A: Because (Moren) did.
665
666 Q: Okay (unintelligible).
667
668 A: (Moren) (unintelligible) yeah.
669
670 Q: Okay.
671

672 A: Yeah there was a lengthy period with no negotiations so I mean nothing was
673 happening.
674

675 Q: Okay.
676

677 A: He by that point was not doing anything, I mean other, (unintelligible) lights
678 were turning off and on in the house so that was being documented so he was
679 still up and around. But he was – once again we tried for several hours, with
680 communications, nothing.
681

682 Q: Right.
683

684 A: So the decision was made to just kind of be available if he wanted to talk or
685 something changed. But with uh (unintelligible) coming up with their
686 negotiators – negotiators that would be their responsibility. And then (Moren)
687 would take over in the morning with some new negotiators to relieve them.
688

689 Q: So you were aware around 9:00 or 9:30 that (Moren) was going to come up.
690

691 A: Oh yeah.
692

693 Q: And you assisted all the way until ...
694

695 A: 1:00 am. I left at 1:00 am.
696

697 Q: Okay and (unintelligible)?
698

699 A: I drove uh [REDACTED] back down because she had to dispatch at noon the
700 next day. But I know (Frinsley) and uh – Sergeant (Frinsley) stayed. And uh-
701 I asked Lieutenant (Kiventa) I said, "I'm looking at leaving, how are you?"
702 He said, "I'm okay." He (unintelligible), "Yeah I'm okay go ahead. Go
703 ahead and go." He said, "Nothing's happening right now, I'm just standing
704 down and we're going to try this again in the morning, um to see if we can get
705 him, you know, to talk to us, but everyone just like stay-stay put." We'll be
706 (unintelligible) we're just trying to wait and see what would happen. And
707 maybe in the morning he-with the new light of the new day maybe he would
708 talk to us and we can get him just to surrender and move on.
709

710 Q: I'm good. Steve is there anything that we haven't asked you that it would be
711 important for us to know about in this incident?
712

713 A: Yeah, there was a CHP officer that was up there too. Um he was in the area
714 sometimes where (Kiventa) was at, and (unintelligible) officer. There was
715 people going around when (George) – (George) and I in the vicinity, in and
716 out of there.

717

718 Q: What do you mean by people?

719

720 A: I'm talking about (Hossler), the tribal chief.

721

722 Q: Okay. Law enforcement.

723

724 A: Law enforcement, yeah only law enforcement. Um the tribal chief was there
725 at times and you, actually Detective Schlesiger actually came up a couple
726 times. As a matter of fact that was when I asked you to make sure that house
727 was evacuated down below us. But yeah, other than that, no.

728

729 Q: Okay. We'll end the interview at 1605.

730

731

732 This transcript has been reviewed with the audio recording submitted and it is an accurate
733 transcription.

734 Signed _____

AGENCY CASE NUMBER
200703162

DEPARTMENT OF JUSTICE
BUREAU OF FORENSIC SERVICES

BFS CASE NUMBER
EU-07-001251-0003

TO: DOJ Alcohol Report Recipient
Humboldt County Sheriff's Office, Eureka
826 Fourth Street
Eureka, CA 95501

FROM: Eureka Laboratory
1011 West Wabash
Eureka, CA 95501
(707) 445-6682 FAX 445-6688

Forensic Alcohol Analysis

OFFENSE DATE:

At the direction of the submitting agency, only those identified in the mailing address will be allowed access to this case. The submitting agency should notify the lab when the prosecutor's office or others should be included.

SUMMARY:

The blood sample (Item 02_01) of [REDACTED] contained 0.00% (W/V) alcohol.
This item contained less than 0.08% (W/V) ethanol and will be forwarded to the BFS Toxicology laboratory for further analysis.

EVIDENCE:

On 12/20/2007, the following evidence was received from [REDACTED] of the Humboldt County Sheriff's Office, Eureka:

Submission 02: One evidence envelope containing one tube of blood from the subject.
Item 02_01: One tube of blood from the subject.

DISPOSITION:

The evidence will be returned to your agency in the normal course of business.

If called as a witness, I would testify that I am employed by the State of California Department of Justice and conducted examinations and formed conclusions as stated in this report. Information regarding the examination and conclusions is recorded at the time of examination. The equipment used in this analysis was in proper working order at the time of this analysis. I, the undersigned, declare this information is true and correct under penalty of perjury.

The undersigned has met the qualifications as set forth in the California Code of Regulations (Title 17, Chapter 2, Subchapter 1, Group 8, commencing with Section 1215) to engage in forensic alcohol analysis in the forensic laboratory named above.

DATE ANALYSIS COMPLETE: 12/28/2007
DATE OF REPORT: 12/28/2007

Technical Reviewer: [REDACTED]

Administrative Reviewer: [REDACTED]

[REDACTED]
Criminalist

AGENCY CASE NUMBER
200703162

**DEPARTMENT OF JUSTICE
BUREAU OF FORENSIC SERVICES**

BFS CASE NUMBER
EU-07-001251-0002

TO: DOJ Alcohol Report Recipient
Humboldt County Sheriff's Office, Eureka
826 Fourth Street
Eureka, CA 95501

FROM: Eureka Laboratory
1011 West Wabash
Eureka, CA 95501
(707) 445-6682 FAX 445-6688

Forensic Alcohol Analysis

[REDACTED]

OFFENSE DATE:

At the direction of the submitting agency, only those identified in the mailing address will be allowed access to this case. The submitting agency should notify the lab when the prosecutor's office or others should be included.

SUMMARY:

The blood sample (Item 01_01) of [REDACTED] contained 0.00% (W/V) alcohol.
This item contained less than 0.08% (W/V) ethanol and will be forwarded to the BFS Toxicology laboratory for further analysis.

EVIDENCE:

On 12/20/2007, the following evidence was received from [REDACTED] of the Humboldt County Sheriff's Office, Eureka:

- Submission 01: One evidence envelope containing one tube of blood from the subject.
- Item 01_01: One tube of blood from the subject.

DISPOSITION:

The evidence will be returned to your agency in the normal course of business.

If called as a witness, I would testify that I am employed by the State of California Department of Justice and conducted examinations and formed conclusions as stated in this report. Information regarding the examination and conclusions is recorded at the time of examination. The equipment used in this analysis was in proper working order at the time of this analysis. I, the undersigned, declare this information is true and correct under penalty of perjury.

The undersigned has met the qualifications as set forth in the California Code of Regulations (Title 17, Chapter 2, Subchapter 1, Group 8, commencing with Section 1215) to engage in forensic alcohol analysis in the forensic laboratory named above.

DATE ANALYSIS COMPLETE: 12/28/2007
DATE OF REPORT: 12/28/2007

Technical Reviewer: [REDACTED]
Administrative Reviewer: [REDACTED]

[REDACTED]

AGENCY CASE NUMBER
200703162

DEPARTMENT OF JUSTICE
BUREAU OF FORENSIC SERVICES

BFS CASE NUMBER
EU-07-001251-0004

TO: DOJ Alcohol Report Recipient
Humboldt County Sheriff's Office, Eureka
826 Fourth Street
Eureka, CA 95501

FROM: Eureka Laboratory
1011 West Wabash
Eureka, CA 95501
(707) 445-6682 FAX 445-6688

Forensic Alcohol Analysis

OFFENSE DATE:

At the direction of the submitting agency, only those identified in the mailing address will be allowed access to this case. The submitting agency should notify the lab when the prosecutor's office or others should be included.

SUMMARY:

The blood sample (Item 03_01) of [REDACTED] contained 0.00% (W/V) alcohol.
This item contained less than 0.08% (W/V) ethanol and will be forwarded to the BFS Toxicology laboratory for further analysis.

EVIDENCE:

On 12/20/2007, the following evidence was received from [REDACTED] of the Humboldt County Sheriff's Office, Eureka:

- Submission 03: One evidence envelope containing one tube of blood from the subject.
- Item 03_01: One tube of blood from the subject.

DISPOSITION:

The evidence will be returned to your agency in the normal course of business.

If called as a witness, I would testify that I am employed by the State of California Department of Justice and conducted examinations and formed conclusions as stated in this report. Information regarding the examination and conclusions is recorded at the time of examination. The equipment used in this analysis was in proper working order at the time of this analysis. I, the undersigned, declare this information is true and correct under penalty of perjury.

The undersigned has met the qualifications as set forth in the California Code of Regulations (Title 17, Chapter 2, Subchapter 1, Group 8, commencing with Section 1215) to engage in forensic alcohol analysis in the forensic laboratory named above.

DATE ANALYSIS COMPLETE: 12/28/2007
DATE OF REPORT: 12/28/2007

Technical Reviewer: [REDACTED]

Administrative Reviewer: [REDACTED]

[REDACTED]
Criminalist

AGENCY CASE NUMBER
200703162

DEPARTMENT OF JUSTICE
BUREAU OF FORENSIC SERVICES

BFS CASE NUMBER
EU-07-001251-0005

TO: DOJ Alcohol Report Recipient
Humboldt County Sheriff's Office, Eureka
826 Fourth Street
Eureka, CA 95501

FROM: Eureka Laboratory
1011 West Wabash
Eureka, CA 95501
(707) 445-6682 FAX 445-6688

Forensic Alcohol Analysis

OFFENSE DATE:

At the direction of the submitting agency, only those identified in the mailing address will be allowed access to this case. The submitting agency should notify the lab when the prosecutor's office or others should be included.

SUMMARY:

The blood sample (Item 04_01) of [REDACTED] contained 0.00% (W/V) alcohol.
This item contained less than 0.08% (W/V) ethanol and will be forwarded to the BFS Toxicology laboratory for further analysis.

EVIDENCE:

On 12/20/2007, the following evidence was received from [REDACTED] of the Humboldt County Sheriff's Office, Eureka:

Submission 04: One evidence envelope containing one tube of blood from the subject.
Item 04_01: One tube of blood from the subject.

DISPOSITION:

The evidence will be returned to your agency in the normal course of business.

If called as a witness, I would testify that I am employed by the State of California Department of Justice and conducted examinations and formed conclusions as stated in this report. Information regarding the examination and conclusions is recorded at the time of examination. The equipment used in this analysis was in proper working order at the time of this analysis. I, the undersigned, declare this information is true and correct under penalty of perjury.

The undersigned has met the qualifications as set forth in the California Code of Regulations (Title 17, Chapter 2, Subchapter 1, Group 8, commencing with Section 1215) to engage in forensic alcohol analysis in the forensic laboratory named above.

DATE ANALYSIS COMPLETE: 12/28/2007
DATE OF REPORT: 12/28/2007

Technical Reviewer: [REDACTED]

Administrative Reviewer: [REDACTED]

[REDACTED]
Criminalist

REQUESTING AGENCY CASE NO.
200703162

CALIFORNIA DEPARTMENT OF JUSTICE
BUREAU OF FORENSIC SERVICES
NORTH COAST REGIONAL CRIMINALISTICS LABORATORY
1011 West Wabash Ave. Eureka, CA 95501-2121
Phone No. (707) 445-6682 FAX No. (707) 445-6688

BFS CASE NUMBER
EU-07-001251-0001

ATTN: Detective. Rich Schlesiger
Humboldt County Sheriff's Department
826 Fourth Street
Eureka, CA 95501

COPIES:

PHYSICAL EVIDENCE EXAMINATION REPORT

████████████████████ OFFENSE: PC 664(E), 187

████████████████████ OFFENSE DATE: JUNE 4, 2007

I, the undersigned, if called as a witness, would testify that I: (1) am employed by the State of California Department of Justice, (2) conducted an examination of, and (3) formed conclusions as stated in this report. I, the undersigned, declare this information is true and correct under penalty of perjury.

Only the agency identified in the mailing address of this report will be allowed access to this case. The submitting agency should notify the lab when the prosecutor's office or other should be included.

SUMMARY:

The four submitted Colt Model M16A2 rifles (3-1, 3-2, 3-3, and 3-4) were intact and in good condition. All four fired and cycled ammunition properly in semiautomatic and automatic modes.

The cartridge case (2-3) was fired in Deputy Taylor's rifle (3-4). Rifles 3-2 and 3-4 can be eliminated as from having fired cartridge cases 2-1 and 2-2. Rifles 3-1 and 3-3 cannot be confirmed or eliminated from having fired evidence cartridge cases 2-1 and 2-2. None of the rifles submitted can be confirmed or eliminated from having fired evidence cartridge case 2-6.

EVIDENCE:

The following evidence was submitted to the Laboratory by ██████████ of the Humboldt Co. Sheriff's Office on July 17, 2007:

2-1	.223 caliber fired cartridge case, military ammunition
2-2	.223 caliber fired cartridge case, military ammunition
2-3	.223 caliber fired cartridge case, military ammunition
2-6	.223 caliber fired cartridge case
3-1 and 3-1A	Colt M16A2 automatic rifle ██████████ magazine with 17 cartridges
3-2 and 3-2A	Colt M16A2 automatic rifle ██████████ magazine with 27 cartridges
3-3 and 3-3A	Colt M16A2 automatic rifle ██████████ magazine with 27 cartridges
3-4 and 3-4A	Colt M16A2 automatic rifle ██████████ magazine with 16 cartridges

EXAMINATION:

The rifles (3-1, 3-2, 3-3, and 3-4) were all intact and functional, including the safety/selector mechanism. The trigger pull measured between 6-7 lbs on all four rifles.

Magazines and unfired .223 REM (5.56 X 45 mm) cartridges were submitted with each rifle (3-1A, 3-2A, 3-3A, and 3-4A). The cartridges submitted as 3-1A, 3-2A, and 3-3A were military ammunition with headstamp markings indicating that they were manufactured at the Lake City Ammunition Plant in 2006. The cartridges submitted as 3-4A were military ammunition with headstamps indicating that they were made by the Federal Cartridge Co. in 2005. Suitable cartridges submitted with each rifle were selected, placed in the appropriate magazine, and test fired in each of the submitted rifles. Each rifle chambered, fired, and ejected cartridges without misfiring or jamming in semiautomatic and automatic modes of fire. The cartridge cases test fired in each of the four rifles were collected and retained for comparison with submitted evidence cartridge cases.

Corresponding toolmarks on evidence cartridge case 2-3 and on cartridge cases test fired in Deputy Taylor's rifle (3-4) had similar class characteristics and sufficient unique characteristics for me to conclude that they shared a common origin.

Two of the evidence cartridge cases (2-1 and 2-2) had headstamps similar to the ammunition submitted with three of the rifles (3-1, 3-2, and 3-3). These two evidence cartridge cases had different corresponding class characteristics as those present on cartridge cases fired in two of the rifles (3-2 and 3-4), and, therefore, were not fired in these two rifles. The presence of similar corresponding class characteristics and a lack of sufficient corresponding unique characteristics made it impossible me to conclusively identify or eliminate rifles 3-1 and 3-3 as the rifles that fired evidence cartridge cases 2-1 and 2-2.

Evidence cartridge case 2-6 had a headstamp indicating that it was made by Winchester. None of the ammunition submitted had this headstamp. Generally, the class characteristics were similar to test fired ammunition from the four submitted rifles. However, the firing pin impression was somewhat different from the ammunition test fired in all four rifles. This could be due to differences in primer composition used in the brands of ammunition used during test firing. Therefore, I can neither confirm nor eliminate evidence cartridge case 2-6 from having been fired in any of the four rifles submitted.

DISPOSITION:

Evidence items 3-1, 3-1A, 3-2, 3-2A, 3-3, 3-3A, 3-4, and 3-4A were returned to the Humboldt Co. Sheriff's Office on July 27, 2007. The remaining submitted evidence and all laboratory generated evidence will be returned to the submitting agency by normal business practice.

EXAMINED BY:

Date of Report: August 20, 2007

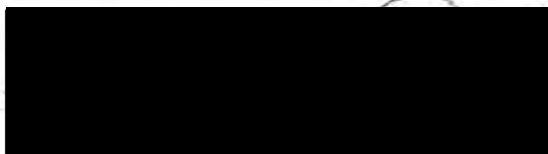

Senior Criminalist

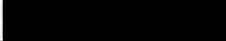
Technical review by:  Date: 8/21/07

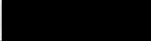
Administrative review by:  Date: 8/21/07



Eureka Fire Department Fire/Arson Investigation Report

F#07-1400

Address: [REDACTED] **Bloody Camp Rd, Hoopa**

Confidential – Not For Release

Day/Date/Time Occurred: 06-04-07, approximately 14:45		Property Classification: Single Family Residence	
Date/Time Reported: 06-04-07, approximately 14:45		Tenant: N/A	
Other Agency/Case No.:		Tenant Insurance Information/policy No.: N/A	
First Arriving Engine/Captain/Crew: Hoopa Fire		Property Owner: [REDACTED]	
		Property Owner address and telephone: [REDACTED] Bloody Camp Road	
Assisting Officer/Detective/Firefighter: [REDACTED] Dave Diemer, HCSO		Hoopa, California [REDACTED] No Phone	
		Property Owner Insurance Co./Agent/Policy: Unknown	
Weather: Partly cloudy		Insurance Amount Structural/Contents: Unknown	
Consent signed by: N/A	Photographs by: White	Drawings by: [REDACTED]	Interviews by: [REDACTED]
Origin and Cause by: [REDACTED]	Search Warrant: N/A	Issued by: N/A	Served by: N/A

Scene: The scene is an older, single wide mobile home with an attached 2-room wood frame addition. The mobile home length runs roughly north-south, with the addition located on the south end of the west side of the mobile. The front door is located on the north side of the addition. There are two rooms in the addition; the south room being accessed through the north room. The kitchen/living room area and north room are open to each other. The front door opens into the north room of the addition. A hall leading north from the kitchen/living area on the east side of the mobile home provides access to (in order south to north) a bedroom, a bathroom and second bedroom. A fire occurred in the south east portion (kitchen area) of the structure, causing significant damage to 70% of the building. The walls of the south 2/3 of the mobile home proper have been burned away, and the metal roof over this same section has collapsed. The wood frame addition has sustained significant damage, but has not suffered any major structural collapse.

[REDACTED] I was informed by Law Enforcement officers on scene that the [REDACTED] was found in the bathroom of the house by initial fire attack crews, wrapped only in wet sheets. The bathroom door was closed, and a towel had been placed over the space between the door and the floor. The [REDACTED] body was removed prior to my arrival. See coroner's report for more information.

Burn Patterns: There were few burn patterns on the outside walls of the structure. There was one partial 'V' pattern on the inside of the west wall of the north room of the wood frame addition. The base of this pattern aligns with the approximate center of the large hole burned in the floor of the residence. There was another partial pattern on the back (west) side and left (south) side of the refrigerator. This pattern indicated that fire came from somewhere to the right (north) of the

Eureka Fire Department Fire/Arson Investigation Report**F#07-1400****Address:** [REDACTED]**Bloody Camp Rd, Hoopa**

unit. Remains of framing members supporting the metal roof of the trailer in the collapse area are virtually nonexistent. Most have been burned away, leaving very few remnants along the edges of the roof panels. The center of this roof collapse is approximately 10 to 12 feet north of the southeast corner of the building. A large portion of the floor was completely burned through in the southeast corner of the building. The wood floor joists beneath the surrounding floor that remains have been severely damaged by fire. These appear to have been 2"x6" before the fire. Numerous floor joists 10 to 18 feet north of the southeast corner have been burned away, leaving only several small pieces on the ground. A section of the ribbon board at the outside ends (east side) of these floor joists was also destroyed. The entire floor under the wood burning stove has been destroyed. Prior to the fire, the wood stove was located north of the refrigerator against a wall separating the addition and the mobile, with the door opening to the east into the kitchen area. The stove had fallen and come to rest on the steel beam that supported the wood floor joists.

Origin(s): Based on the amount and location of burn damage, destroyed/missing structural components, and the partial 'V' pattern on the wall of the wood frame addition, I believe the area of origin of this fire is 10 to 18 feet north of the south wall of the home, and 3 to 7 feet west of the east wall of the home. This location is roughly northeast of the wood stove door, in an area between the living room and the kitchen. This area would be visible from both the south and east windows in the kitchen.

Ignition Sources: Numerous potential ignition sources were found in or near the area of origin. A kerosene lamp, Coleman type lantern, the remains of 2 small oil lamps, and a handheld plumber's torch were found the area to the south of the refrigerator. Upon examination, we found that the valve of the torch was securely in the closed position, and the tank was empty. We believe that because of its condition and location it is most probable that the torch was not an ignition source of the fire. A heating element, of a size consistent with the remains of a waffle iron, the remains of 2 oil lamps, the wood stove, and a metal refillable cigarette lighter were found in the area of origin.

The property owner, [REDACTED] stated that there was no fuel for any of the oil lamps or lanterns since he ran out during the snowstorm in February. He had not been able to purchase any fuel and had resorted to candles for light.

Utilities/Appliances: There was a microwave oven, propane gas stove/oven, and electric refrigerator in the kitchen. According to [REDACTED] there were several electric outlets on the walls above the kitchen counter. Any outlets closer to the area of origin are unknown. The propane supply line serving the stove/oven ran from the tank at the northeast corner of the house down the east wall to the kitchen, where it terminated on the east wall of the house approximately 10 feet from the southeast corner. The gas supply valves at the tank and the stove were both in the open position at the time of the fire. The pilot lights to the stove were lit at the time of the fire. The supply valves were closed post extinguishment by Hoopa Fire personnel. The gas furnace and water heater are both located remote from the area of origin.

Extent of Damage: See Burn Patterns above. The contents in the area of origin were a total loss. The contents in parts of the house remote from the area of origin (north of the collapse zone) were presumably less damaged but not salvageable.

Eureka Fire Department Fire/Arson Investigation Report

F#07-1400

Address: [REDACTED] Bloody Camp Rd, Hoopa

Witness(s): Interviewed

X [REDACTED] Property owner: I spoke with [REDACTED] while he was a patient at St. Joseph Hospital for an unrelated illness on 06-08-07 at 14:30. He was completely lucid and alert, answering all of my questions. He stated that he had not had any fuel for any of his oil lamps or lanterns since the snowstorm in February, and had not been able to purchase any since. He said that since February, he and his family had relied on candles for light, and that the electricity was "sporadic" in the winter. [REDACTED] stated that the only flammable liquids he could think of that were in the house were a quart of motor oil under the kitchen sink, and a chainsaw with a full gas tank in the back bedroom. The cook stove had been cleaned recently, and the pilot lights were lit. One of the burners on the gas cook stove did not work properly. The wood stove was not lit at the time [REDACTED] entered the house. [REDACTED] stated that the door to the wood stove did not latch, and that he used a chunk of concrete to hold the door shut when operating it.

X Charlie VanBuskirk, Deputy Coroner: I spoke with Mr. VanBuskirk on 06-08-07 at 11:50. He stated that the decedent had soot in his lungs, and burns to his trachea. He also had some "skin slip" on his right hand, a burn on his right shoulder, and no traumatic injuries. He believed that the burn on [REDACTED] shoulder was from burning material dropping from the ceiling of the bathroom. There was an unknown florescent substance on his right shoulder. Samples for a toxicology report had been sent away, but results were not back yet.

X Deputy Dave Lundie, HCSO: I spoke with Deputy Lundie by telephone at 16:35 on 06-17-07. He stated that while he was stationed on "side 3" of the fire building (east side), he did not see any windows in his view that were broken out. He said that during the incident, he was able to see "white smoke" from the wood burning stovepipe of the house. After the gas canisters were deployed into the house, he was able to see what appeared to be white smoke coming from the windows on the "#4 side" (south) of the building. Lundie also stated that he noticed a separation between the time the gas canisters were deployed and the time the fire started. He said that the smoke from the gas canisters was coming out in puffs, and that the smoke coming from the window when the fire started was light colored and steady; and that the window on "the #3 side" darkened and he could hear crackling from inside the house. Lundie said that there were lights and a television on at night, and that he could hear [REDACTED] moving around in the house during the course of the incident.

Deputy Kevin Miller, HCSO: I spoke with Deputy Miller by telephone at 16:30 on 06-18-07. He stated that he was stationed on the #1 (west) side of the house during the incident. He observed that from his vantage point, the skirting covering the crawlspace under the house was in place at the time of the fire, and that members of the fire department had removed it during suppression operations. He also stated that the bedroom window on the #1 (west) side was broken out at the time of the fire. Miller also stated that he first saw black-gray smoke coming from the wood burning stovepipe after the gas canisters were deployed. He said that it was lazy at first, and then appeared to increase in velocity as the fire progressed. He did not see any smoke at the time the canisters were deployed, but was able to see a distinct difference between the smoke from the gas canisters and the smoke from the fire.

Deputy Miller said that the white smoke from the canisters had dissipated before the smoke was visible from the wood burning stovepipe. It came from the stovepipe "for a long time", and then began to come out the vent pipes, then the roof, and finally the eaves of the house. He

Eureka Fire Department Fire/Arson Investigation Report

F#07-1400

Address: [REDACTED] Bloody Camp Rd, Hoopa

said that the windows that were not broken were "blacked out" from the smoke, and he first saw flames from the roof by the wood burning stovepipe, near the #4 (south) side. Miller also said that there were lights on at night, and he was observing the house through a night vision device after dark.

Deputy Kerry Ireland, HCSO: I e-mailed a list of the same questions that I had asked of the other Deputies to Deputy Ireland on 06-29-07. I received a reply from him via e-mail on 07-12-07. Deputy Ireland stated that at various times he was positioned between 50 yards and 20 feet from the #3 / #4 (east and south) side of the house during most of the incident. The left (west) window on the #4 (south) side had been broken out at the time of the fire. Ireland stated that he observed lazy smoke coming from the wood burning stovepipe prior to seeing flames coming from the #4 (south) side of the house; and that he saw flames from the left (south) window on the #3 (east) side before the house became well involved. He also stated that "between the hours of 2100 on Sunday and 0400 on Monday, the [REDACTED] had started a fire in the stove. I could smell smoke with the scent being consistent with that of a wood burning stove fire." He also said that the [REDACTED] lit a candle during the morning hours, and that he was able to observe some light from the fire in the wood stove with the aid of his night vision goggles. Deputy Ireland also stated that after the gas canisters had been deployed, he was able to differentiate between the gas cloud and smoke from the fire in the house. The gas had not fully dissipated when he noticed that the 'smoke' turned from a whitish color (gas) to whitish brown, and darken to gray. The smoke was coming from the #4 (south) side of the house.

[REDACTED] X Interviewed

[REDACTED]

Investigation Summary: I was notified of this incident at approximately 19:30 on June 5, 2007, and was instructed to report to Arcata Fire's Mad River Station at 06:30 the following morning. The information I received was that an individual had barricaded himself in a house in Hoopa, and that it had burned, causing fatal injuries to the individual. Upon arriving at the station, I was met by Dave White from Arcata Fire and Dave Diemer from HCSO. White and I drove the HCF/AIU investigation van to the incident, and Diemer arrived in his patrol vehicle. Upon arrival, we met with HCSO evidence technician [REDACTED]. We first toured the site, noting locations of evidence that [REDACTED] wanted left undisturbed. We then began our examination of the house.

We first noticed the remains of a Coleman-type lantern, another kerosene lantern, and two smaller oil lamps on the south side of the building, in close proximity to the refrigerator. We examined these items and photographed them in place. The first layer of debris we removed was the remains of the metal roof. There were very few remaining wood structural components attached to the roof panels. The roof panels were separated and placed in a pile away from the house. Next we removed the remains of the cook stove, and placed it near the roof panels. It was located on the east wall of the kitchen prior to the fire. The stove did not appear to have any remarkable patterns on it. Investigator White examined the gas supply line to the stove, and found no obvious defects. The pipe was in its original location, running south along the base of the east wall of the mobile to the kitchen area. It entered the house directly behind the cook stove. He then bent the pipe back to the north (resulting in a 'U' shape) to allow better access to the interior of the debris pile.

Investigator White, Deputy Diemer and I then began to examine the debris in the area of greatest damage. Much of this debris consisted of what appeared to be charred wood; golf ball

Eureka Fire Department Fire/Arson Investigation Report**F#07-1400****Address:** [REDACTED] **Bloody Camp Rd, Hoopa**

size and smaller. There were also numerous food cans mixed in the debris. Many of these cans had ruptured or expanded as their contents heated and expanded during the fire. Within several feet of the east wall of the house we found an ammunition magazine for a handgun, and several spent .223 cartridges. We advised evidence technician [REDACTED] and she photographed and collected them. A short time later, Investigator White found the remains of what appeared to be a tear gas canister that had been deployed into the house. It was located several feet north of the remains of an oil lamp. Both items were found in the area of origin. Other deputies on scene stated that there had been a total of 4 canisters deployed. Two of them were found by law enforcement personnel in the addition. We did not find the fourth canister. We finished clearing the debris to a point 1-2 feet under the remaining floor, noting several concentrations of papers resembling magazines, and piles of material appearing to be burned clothing. Investigator White removed some debris from the floor area near the edge, finding no other ignition sources. We did not clear the remaining floor area or under it because it was unstable and posed a safety hazard to fire investigation personnel. Using long handled tools, we removed the burned debris from under the wood stove, finding the missing legs and a portion of the broken hearth. We also found the piece of concrete [REDACTED] later stated during our interview at St. Joseph Hospital he used to hold the wood stove door shut. I removed the refrigerator door to examine it for burn patterns. It appeared to have been forced off its hinges and fallen straight out from the refrigerator when the roof collapsed, and landed on the floor with the inside facing up. There were two protected areas on the outside lower right corner of the door. I was unable to determine the source of the protection. We finished clearing debris from the southeast corner of the house, finding only another ammunition magazine for a handgun. This was photographed and collected by [REDACTED]

Investigator White found and examined the furnace. He also located and photographed the water heater, but was unable to access it directly due to debris. Both appliances were located remote from the area of origin, and he informed me that they gave no indication of having been an ignition source for the fire.

Prior to concluding our scene examination, we suggested that HCSO arrange to conduct a test using an exemplar gas canister in order to determine the possibility of the canister being an ignition source. As of the date of this report, I have not received any information to indicate that this has been done. At no time during our examination of the scene did we find any indicators (smells, oily looking residues) that there may have been ignitable liquids present in the house. Therefore, we did not check for the presence of hydrocarbons with an electronic hand held detector.

On June 8, 2007 I spoke with Charlie VanBuskirk of the Humboldt County Coroner's Office. I inquired about the findings from the autopsy performed [REDACTED] the previous day. He stated that the decedent had soot in his lungs, and burns to his trachea. He also had some "skin slip" on his right hand, a burn on his right shoulder, and no traumatic injuries. This information did not include or exclude the victim from being a contributing factor to the cause of the fire. It merely indicates that at some point, the victim was exposed to hot products of combustion, and that his hand was close enough to the fire to be injured.

On June 21, 2007 at 15:05, I spoke with VanBuskirk again and inquired about the results of the toxicology report for the deceased. [REDACTED]

Conclusions: Based on the interviews I have conducted and the indicators found at the scene, I believe that it is most probable that this fire originated on the floor of the residence, near the front of the wood stove. Its apparently rapid spread is most likely due to a large amount of combustibles

Eureka Fire Department Fire/Arson Investigation Report

F#07-1400

Address: [REDACTED] **Bloody Camp Rd, Hoopa**

(including but not limited to newspapers, magazines, clothing, furniture, floor coverings and possibly live ammunition) in or near the area of origin and a ready supply of oxygen from the broken windows of the house.

I believe that the deceased had the capacity and the materials to start a fire, but cannot determine if the fire was a direct result of his actions. If the deceased did start the fire, I also cannot determine if it was started with the intent of cooking, warming or with intent to cause harm to himself or others. Without additional information, I also cannot determine if the gas canisters deployed by law enforcement personnel generated sufficient heat to cause ignition of items in the area of origin. The exact cause of this fire is undetermined.

Case Status:	<input type="checkbox"/> Closed	<input checked="" type="checkbox"/> Continuing			
Other:	H.C.F./A.I.U.	<input checked="" type="checkbox"/> Yes	<input type="checkbox"/> No		
	Lab Reports	<input type="checkbox"/> Yes	<input type="checkbox"/> No		
	Supplementary Report	<input type="checkbox"/> Yes	<input type="checkbox"/> No		
Attachments:					Agency
Fire Report	<input type="checkbox"/> Yes	<input checked="" type="checkbox"/> No	#		
Police Report	<input type="checkbox"/> Yes	<input checked="" type="checkbox"/> No	#		
Evidence Log	<input type="checkbox"/> Yes	<input checked="" type="checkbox"/> No			
Photo Log	<input checked="" type="checkbox"/> Yes	<input type="checkbox"/> No			HCF/AIU D.White
Investigator Signature/Date: Jeffrey C Nicklas 09-05-07				Approved/Date: William L. Gillespie 11-15-07	

**HUMBOLDT COUNTY SHERIFF'S OFFICE
PROPERTY/EVIDENCE BOOKING AND RELEASE REPORT**

CASE NUMBER: 20070362

PAGE 1 OF 1

DATE STORED <u>2/6/08</u>	TIME STORED <u>200915</u>	DATE OF INCIDENT <u>6/3/07</u>	CRIME <u>664/187 CAS P.C.</u>
NAME OF FINDER (ADDITIONAL VICTIM) <u>STATE OF CALIFORNIA</u>		DOB	ADDRESS
LOCATION PROPERTY WAS FOUND (INCIDENT OCCURRED) <u>Buddy Camp Rd at</u>		<u>Hoopa, CA.</u>	

ADULT ARREST
 JUVENILE ARREST
 SEARCH WARRANT NO. N/A

TYPE OF PROPERTY
 EVIDENCE FOUND SAFEKEEPING

PROPERTY CODES *178

S - Stolen	D - Damaged
R - Recovered	L - Lost
RA - Recovered (For Other Agency)	E - Evidence
F - Found	K - Safekeeping
	C - Contraband

PROPERTY/EVIDENCE LISTING

CODE	ITEM NO.	QTY.	DESCRIPTION	VALUE	NCIC	WEIGHT	DISPOSITION
<u>E</u>	<u>1</u>	<u>1</u>	<u>CD RECEIVED FROM ARSON TASK FORCE INVESTIGATOR NICKLAS.</u>				

OWNERS OF PROPERTY

ITEMS NO. <u>1</u>	NAME <u>HCSO</u>	DOB	ADDRESS	PHONE	NOTIFIED
ITEMS NO.	NAME	DOB	ADDRESS	PHONE	NOTIFIED
ITEMS NO.	NAME	DOB	ADDRESS	PHONE	NOTIFIED

LAB WORK REQUIRED

ITEMS NO.	PURPOSE OF EXAM
ITEMS NO.	PURPOSE OF EXAM
ITEMS NO.	PURPOSE OF EXAM

PIN <u>0984</u>	REPORT DATE <u>2/6/08</u>	SUPERVISOR REVIEW	PIN	REPORT DATE
-----------------	---------------------------	-------------------	-----	-------------

CASE FILE COPY

AGENCY CASE NUMBER
200703162

DEPARTMENT OF JUSTICE
BUREAU OF FORENSIC SERVICES

BFS CASE NUMBER
TX-07-012842-0001

TO: DOJ Toxicology Report Recipient
Humboldt County Sheriff's Office, Eureka
826 Fourth Street
Eureka, CA 95501

FROM: Toxicology
4949 Broadway, Rm F249
Sacramento, CA 95820
(916)227-3620 FAX (916)227-4751

Toxicology Screen and Confirm

OFFENSE DATE: 6/4/2007

SUMMARY:

The toxicological results of the blood sample from [REDACTED] are listed below.

The following compounds were not detected in the sample by gas chromatography/mass spectrometry (GC/MS): certain stimulants (including methamphetamine and cocaine and/or cocaine metabolites), tranquilizers, common narcotics, antidepressants, psychedelics (including phencyclidine), benzodiazepines, sedative/hypnotics (including barbiturates), and anticonvulsant drugs. Cannabinoids were not detected by immunoassay. Caffeine, nicotine and/or their metabolites may be present but are not routinely reported.

Phencyclidine (PCP) was initially indicated below the positive immunoassay calibrator but was not confirmed by GC/MS. The presumptive immunoassay screening was repeated and phencyclidine was not indicated. The blood sample is therefore negative for phencyclidine (PCP).

The presumptive immunoassay (IA) results for the sample are listed below along with the cutoff levels for each drug. The number of drugs that are confirmed is dependent upon the type of contract our laboratory has with your agency.

Confirmation of any other drugs, including benzodiazepines and/or marijuana (THC) is available at an additional cost. Please allow two weeks for confirmatory analysis. Confirmatory analysis is required prior to a court appearance by a toxicologist.

<u>Immunoassay Classification</u>	<u>Result</u>	<u>Cutoff</u>
Benzodiazepines	Negative	100 ng/mL
Cocaine	Negative	150 ng/mL
Marijuana	Negative	30 ng/mL
Methamphetamine	Negative	50 ng/mL
Opiates	Negative	10 ng/mL
PCP	Negative	10 ng/mL

EVIDENCE:

On 12/31/2007, the following evidence was received from Property Controller [REDACTED] of the Bureau of Forensic Services, Eureka Laboratory via GSO/Central Services rep:

Submission 01: One evidence envelope containing one tube of blood from the subject.

Item 01_01: One tube of blood from the subject.

COPY TO
EVIDENCE FILE
2-21-08 [REDACTED]

DISPOSITION:

Samples for misdemeanor driving and contract cases will be retained in the Toxicology Laboratory for one year and then destroyed, unless other arrangements have been made. Samples from felony driving offenses are retained for one year and returned to the submitting laboratory. The samples for non-driving felony cases will be returned to the submitting laboratory/agency.

If called as a witness, I would testify that I am employed by the State of California Department of Justice and conducted examinations and formed conclusions as stated in this report. Information regarding the examination and conclusions are entered into and are maintained within the DOJ Laboratory Information Management System (LIMS) database. I, the undersigned, declare this information is true and correct under penalty of perjury.

DATE OF ANALYSIS: 2/4/2008

DATE OF REPORT: 2/11/2008

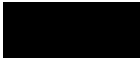
Technical Reviewer: 

Administrative Reviewer: 

Forensic Toxicologist

cc: DOJ Toxicology Report Recipient DAHUMB 707-445-7416 Related Case(s): EU071251

**HUMBOLDT COUNTY SHERIFF'S OFFICE
PROPERTY/EVIDENCE BOOKING AND RELEASE REPORT**

CASE NUMBER: 200703162

PAGE 1 OF 2

DATE STORED <u>12/27/07</u>	TIME STORED <u>1300</u>	DATE OF INCIDENT <u>12/3/07</u>	CRIME <u>664/187 PC, OIS</u>
NAME OF FINDER (ADDITIONAL) <u>State of California</u>		DOB	ADDRESS <u>664/187 PC, OIS</u>
NAME OF FINDER (ADDITIONAL)		DOB	ADDRESS
LOCATION PROPERTY WAS FOUND (INCIDENT OCCURRED) <u>Bloody Camp Rd. at Hostler Ranch - Hoopa, CA.</u>			

ADULT ARREST
 JUVENILE ARREST
 SEARCH WARRANT NO. N/A

TYPE OF PROPERTY
 EVIDENCE FOUND SAFEKEEPING

PROPERTY CODES *178

S - Stolen	D - Damaged
R - Recovered	L - Lost
RA - Recovered (For Other Agency)	E - Evidence
F - Found	K - Safekeeping
	C - Contraband

PROPERTY/EVIDENCE LISTING

CODE	ITEM NO.	QTY.	DESCRIPTION	VALUE	NCIC	WEIGHT	DISPOSITION
E	1	13	AUDIO TAPED STATEMENTS, RECEIVED FROM INV. HONZA: COOPER, R. SWIFT, BARNETT, SANCHEZ, RICKER, HARRHAM, HIGGSON, OLSON, T. WILCOX, WILSON, ROBERTS, DORNBACK, KAY HONZA.				
E	2	16	CD STATEMENTS: RECEIVED FROM INV. DUNN LT. MURPHY, LT. KNIGHT, DEP. GAMB, DEP. TAYLOR, DEP. BARNEY, SGT. QUINNELL X 2, LT. CAUNITA. RECEIVED FROM SGT. EDWARD LUNDKE, MILLER, MASSARD, FULTON, BISHOP. RECEIVED FROM CHIEF INV. HOSLER. RECEIVED FROM SGT. SILVEAS OFF. HILL. SGT. JOHNSON. RECEIVED FROM DET. QUINNELL CHIEF HOSTLER. DISPATCH 911 CALL. RANDY GARCIA, JESSE TAYLOR, KEERY IRLAND.				

OWNERS OF PROPERTY

ITEMS NO.	NAME	DOB	ADDRESS	PHONE	NOTIFIED
<u>1-2</u>	<u>HCSO</u>				
ITEMS NO.	NAME	DOB	ADDRESS	PHONE	NOTIFIED
ITEMS NO.	NAME	DOB	ADDRESS	PHONE	NOTIFIED

LAB WORK REQUIRED

ITEMS NO.	PURPOSE OF EXAM
ITEMS NO.	PURPOSE OF EXAM
ITEMS NO.	PURPOSE OF EXAM

BOOKING OFFICER <u>RICH. HESLER</u>	PIN <u>0931</u>	REPORT DATE <u>12/27/07</u>	SUPERVISOR REVIEW	PIN	REPORT DATE
----------------------------------------	--------------------	--------------------------------	-------------------	-----	-------------

**HUMBOLDT COUNTY SHERIFF'S OFFICE
PROPERTY/EVIDENCE BOOKING AND RELEASE REPORT**

CASE NUMBER: 200703162

PAGE 2 OF 2

DATE STORED 12/27/07	TIME STORED 1300	DATE OF INCIDENT 6/3/07	CRIME 624/187PC., DIS
VICTIM STATE OF CALIFORNIA	DOB	ADDRESS	PHONE
NAME OF FINDER (ADDITIONAL)	DOB	ADDRESS	PHONE
LOCATION PROPERTY WAS FOUND (INCIDENT OCCURRED) BLOODY CAMP RD. AT HOSTLER RANCH - HOOPA, CA.			

ADULT ARREST
 JUVENILE ARREST
 SEARCH WARRANT NO. N/A

TYPE OF PROPERTY
 EVIDENCE FOUND SAFEKEEPING

PROPERTY CODES *178

S - Stolen	D - Damaged
R - Recovered	L - Lost
RA - Recovered (For Other Agency)	E - Evidence
F - Found	K - Safekeeping
	C - Contraband

PROPERTY/EVIDENCE LISTING

CODE	ITEM NO.	QTY.	DESCRIPTION	VALUE	NCIC	WEIGHT	DISPOSITION
E	3	1	FLAMELESS TRI-CHAMBER CS MUNITION, RECEIVED FROM INV. HONSAL.				
E	4	1	HAN-BALL CS MUNITION, RECEIVED FROM INV. HONSAL.				
E	5	1	CS EXPANSION GRENADE, RECEIVED FROM SET. QUEWELL.				
E	6	2	DC + CS SHOTGUN BARRICADE PROJECTILE, FROM SET. QUEWELL.				
E	7	1	37MM FERRET CS MUNITION, RECEIVED FROM OFFICER JONES.				
E	8	1	SKETCH OF SCENE USED BY CIRT TEAM.				

OWNERS OF PROPERTY

ITEMS NO.	NAME	DOB	ADDRESS	PHONE	NOTIFIED
5-8	HCSO				

LAB WORK REQUIRED

ITEMS NO.	PURPOSE OF EXAM

BOOKING OFFICER RICH S. BEILER	PIN 0931	REPORT DATE 12/27/07	SUPERVISOR REVIEW	PIN	REPORT DATE
-----------------------------------	-------------	-------------------------	-------------------	-----	-------------

**HUMBOLDT COUNTY SHERIFF'S OFFICE
PROPERTY/EVIDENCE BOOKING AND RELEASE REPORT**

CASE NUMBER: 200703162

PAGE 1 OF 1

DATE STORED <u>1/24/08</u>	TIME STORED <u>1015</u>	DATE OF INCIDENT <u>6/3/07</u>	CRIME <u>644/187(a) P.C., OIS</u>
NAME OF FINDER (ADDITIONAL) <u>State of California</u>		DOB	ADDRESS
NAME OF FINDER (ADDITIONAL)		DOB	ADDRESS
LOCATION PROPERTY WAS FOUND (INCIDENT OCCURRED) <u>Blossy Camp Rd. @ Hazel Ranch - Healdsburg, CA.</u>			

ADULT ARREST
 JUVENILE ARREST
 SEARCH WARRANT NO. N/A

TYPE OF PROPERTY
 EVIDENCE FOUND SAFEKEEPING

PROPERTY CODES *178

S - Stolen	D - Damaged
R - Recovered	L - Lost
RA - Recovered (For Other Agency)	E - Evidence
F - Found	K - Safekeeping
	C - Contraband

PROPERTY/EVIDENCE LISTING

CODE	ITEM NO.	QTY.	DESCRIPTION	VALUE	NCIC	WEIGHT	DISPOSITION
E	1	19	CD PHOTOS OF WEAPONS & CP, CD PHOTOS OF TO DO LIST, CD STATEMENTS: <u>Set. Lowmyer, Off. Sparlingo, Off. Nolan, Dep. Berry, Off. Landrevaux, Dep. Daniels, Sgt. Noua, Off. Jones, Off. Hutz, Sgt. Curran, Dep. Taylor, Sgt. Pringle.</u>				
E	2	5	PHOTOS SHOWN TO INVOLVED OFFICERS				

OWNERS OF PROPERTY

ITEMS NO. <u>152</u>	NAME <u>HCSO</u>	DOB	ADDRESS	PHONE	NOTIFIED
ITEMS NO.	NAME	DOB	ADDRESS	PHONE	NOTIFIED
ITEMS NO.	NAME	DOB	ADDRESS	PHONE	NOTIFIED

LAB WORK REQUIRED

ITEMS NO.	PURPOSE OF EXAM
ITEMS NO.	PURPOSE OF EXAM
ITEMS NO.	PURPOSE OF EXAM

BOOKING OFFICER <u>RICH - 25162</u>	PIN <u>0934</u>	REPORT DATE <u>1/24/08</u>	SUPERVISOR REVIEW	PIN	REPORT DATE
----------------------------------------	--------------------	-------------------------------	-------------------	-----	-------------

HUMBOLDT COUNTY SHERIFF'S DEPARTMENT
EVIDENCE REPORT
SUPPLEMENTAL REPORT

Classification: Officer Involved Shooting

HCSO Case: 200703162

Evidence Tech: [REDACTED]

Investigator: C.I.R.T.

Occurred: Bloody Camp Rd.

Date Reported: 06-03-2007

Hoopa

[REDACTED] Residence

[REDACTED]
[REDACTED]
[REDACTED]
[REDACTED]
DOB: 02-04-1981

On June 4, 2007, I was contacted by Detectives Schlesiger and Quenell regarding an officer involved shooting incident that occurred in Hoopa. Detective Schlesiger requested my assistance in processing the scene. I was told that the [REDACTED] was inside a residence and had fired a weapon at law enforcement personnel. I was told that law enforcement personnel had returned gunfire. I was told the [REDACTED] was still inside the residence and negotiations were taking place between the [REDACTED] and law enforcement.

At approximately 1140 hours, I arrived at Bloody Camp Rd. in Hoopa and met with Detective Schlesiger, Detective Quenell and D.A. Investigator Steve Dunn. I was informed the [REDACTED] was still inside the residence. I observed numerous law enforcement and emergency personnel on scene from the Humboldt County Sheriff's Office, Humboldt County District Attorney's Office, Eureka Police Department, California Highway Patrol, Hoopa Valley Volunteer Fire Department, Pelican Bay State Prison Negotiators, Yurok Tribal Police Department, Ambulance Personnel and Hoopa Valley Tribal Police. Refer to personnel and crime scene logs for details.

Upon my arrival, I took digital photographs of the dry erase boards located inside the HCSO Command Van, which contained personnel assignments and a drawing of the residence. I was told that negotiations were continuing with the [REDACTED] [REDACTED] [REDACTED]

Detective Schlesiger requested I assist HCSO Detective Kirkpatrick and EPD Detective Lawson with a search of [REDACTED] residence. At approximately 1335 hours, I cleared the scene and followed Detective Kirkpatrick and Detective Lawson to Masten Flats located on Pine Creek Rd. in Hoopa. We arrived at the residence at approximately 1410 hours.

I took the following GPS reading at [REDACTED] residence: [REDACTED] [REDACTED]. There was no physical address for the residence. The residence was a singlewide, [REDACTED] mobile home. There was a [REDACTED] Ford pickup with California license plate [REDACTED] parked southwest of the mobile home. The bed of the pickup was full of garbage. There was an additional wooden structure located on the property. The Detectives found the front door unlocked. They entered the residence to check for occupants. The mobile home was found empty.

Using a Nikon digital camera, I proceeded to photograph the exterior and interior of the residence. I continued to photograph throughout the search. Using a digital video recorder, I took a video of the exterior and interior of the residence. The video file was later transferred to DVD and booked into evidence. The door entered into the living room area with the kitchen located to the left. There was a hallway off of the kitchen, which led to the bathroom and the bedroom.

We photographed and collected the following items from inside the residence: [REDACTED] located on the kitchen table; indicia for [REDACTED] P.O. Box [REDACTED] Hoopa located on the kitchen table; 4 Super X cartridges, 1 - .44 REM Mag cartridge, 3 WIN .380 Auto cartridges, 3 - .22 long cartridges and 2 - 20 GA shotgun shells located on the top shelf of the bedroom closet; indicia for [REDACTED] and [REDACTED] located on the top shelf of the bedroom closet. I later booked these items into evidence.

We located several phone numbers handwritten on paper. Detective Kirkpatrick requested I take photographs of these items. These items were not collected.

We searched the interior and exterior of the mobile home and the additional structure. We did not locate any weapons or other significant evidence.

We concluded our search at approximately 1510 hours.

I took a total of 63 digital photographs. The digital photographs were later transferred to CD ROM and booked into evidence.

I cleared the residence and started enroute to Bloody Camp Rd. The area of Bloody Camp Rd. was clearly visible from Pine Creek Rd., which is located in the valley of Hoopa. While enroute to the scene, I noticed what appeared to be smoke in the vicinity of Bloody Camp Rd. At approximately 1526 hours, I proceeded to take photographs of the smoke. I took a total of 7 digital photographs within a 3 minute time period. I did not notice any visible flames. The digital photographs were later transferred to CD ROM and booked into evidence. After photographing I continued to travel back to the scene.

I arrived on scene at approximately 1543 hours. I was told that the residence was on fire and [REDACTED] was inside. Per Investigators, I proceeded to take photographs. I walked down the gravel driveway leading from Bloody Camp Rd. to the residence. I was told that law enforcement vehicles, which had been parked in the driveway, had been moved prior to my arrival. The vehicles were moved to facilitate entry of the Fire and Rescue vehicles. I was told the front and rear tires of the law enforcement vehicles had been marked before they were moved. As I walked down the driveway to the residence, I took photographs of the tire markings on the driveway. At approximately 1549 hours, I noticed flames at the residence. I continued to take photographs throughout the incident. Due to safety issues, Detective Quenell and Deputy Massaro approached the residence and took additional photographs using the Nikon camera.

Using a digital video recorder, I took several videos of the fire. Due to safety issues, Sgt. Quenell assisted me by taking some of the video footage. I later transferred 7 video files to DVD and booked them into evidence.

During fire extinguishing efforts, I proceeded to photograph and search the area of the driveway for possible evidence. The gravel driveway was located on the west side of

Bloody Camp Rd. The driveway traveled in a west and north direction to the residence approximately .2 of a mile. There was an additional residence located on the south side of the driveway. The driveway traveled north, past [REDACTED] residence, to the [REDACTED] residence. I was told [REDACTED] was the owner of the property.

The painted tire markings on the driveway indicated the locations of the four law enforcement vehicles. I was told that the two vehicles, closest to the residence, were from the Hoopa Valley Tribal Police Department. I was told the vehicles, closest to Bloody Camp Rd., were from the Hoopa Valley Tribal Police Department and the Humboldt County Sheriff's Office. The HVTP vehicle was parked in front of the HCSO vehicle. The tire locations of the vehicles were marked in yellow and pink paint. The vehicles had been moved prior to my arrival.

I observed 3 - .223 expended cartridge cases on the driveway next to the HVTP vehicle in the first position closest to the residence. The expended cartridge cases were located on the driver's side of the vehicle. I marked these items with pink paint. I collected these items immediately after photographing so they would not be lost due to foot and vehicle traffic. I later booked these items into evidence.

I noticed several expended CS cartridges lying on the south side of the driveway near the position of the first HVTP vehicle. I took photographs of the cartridges. I moved the cartridges to the edge of the driveway to allow Emergency Vehicles to pass.

I proceeded to take photographs of the exterior of the residence. Fire personnel were in the process of extinguishing the fire. Detective Schlesiger took me to the west wall of the residence. A square section had been cut out of the wall. I was told this was the bathroom of the residence and [REDACTED] was found deceased on the floor. I took photographs of the bathroom [REDACTED].

Detective Schlesiger informed me that an involved vehicle from Yurok Tribal Police Department was parked in the driveway on the north west side of the residence. Detective Schlesiger requested I take photographs of the vehicle prior to being removed. I met with HCSO Sgt. Garcia and took photographs of the vehicle and a safety shield used by Officer's during the incident.

Detective Schlesiger requested I photograph a group of Agents from the Pelican Bay C.I.R.T. Team. I was told these C.I.R.T. members had not been directly involved in the incident. I took 2 digital photographs of the team.

At approximately 1630 hours, I was informed the Humboldt County Coroner's Office had been notified and was enroute.

Detective Schlesiger informed me that the two HVTP vehicles, which had been parked closest to the residence, were moved to the hillside located northeast of their original positions. The first vehicle contained a California license plate number [REDACTED] and the second vehicle contained a U.S. Govt plate number [REDACTED] with a vehicle number of [REDACTED]. Per Detective Schlesiger, I took photographs of the vehicles. I noticed that the vehicle containing license plate number [REDACTED] had indentations and a hole in the hood. I took photographs of the damage. There was a tactical vest located in the rear cargo area of the vehicle containing license plate number [REDACTED]. I was told this

tactical vest belonged to the Pelican Bay C.I.R.T. agents. Per Detective Schlesiger, I took photographs of the vest before it was returned to the agents.

I was informed that Ambulance personnel had located two expended cartridge cases in the driveway. I observed 1 - .223 expended cartridge and 1 - 9mm expended SIMS cartridge case. The expended cartridges were located on the driver's side of the Humboldt County Sheriff's Office vehicle. I marked these two items with yellow paint and took photographs. I collected the cartridge cases and later booked them into evidence.

At approximately 1745 hours, I assisted D.A. Investigator Honsal in collecting clothing and equipment from HCSO Sgt. Bryan Quenell, HCSO Deputy Jamie Barney, HCSO Deputy Anthony Gomes and HCSO Deputy Brian Taylor. I was informed that D.A. Chief Investigator Mike Hislop had photographed and performed examinations on the weapons and ammunition used by the involved Officers. Refer to Hislop's report for details. Per Detective Schlesiger, these were the Law Enforcement Officers on scene that had fired their weapons. The clothing was placed in separate evidence bags. Per Detective Schlesiger, the items were to be examined for possible evidence and returned to the Officers. These items were not booked into evidence. Detective Schlesiger informed that there was no physical contact between the [REDACTED] and the Officers. Refer to Detective Schlesiger's report for details.

At approximately 1845 hours, Humboldt County Deputy Coroner Charles Van Buskirk arrived on scene. Detective Schlesiger requested I take additional photographs and video of the body prior to removal. The video file was later transferred to DVD and booked into evidence.

The [REDACTED] was unclothed and had black soot over most of his body. There were several sheets and blankets lying on the floor of the bathroom. We noticed red clothing on top of the toilet seat. I was told the [REDACTED] had been seen through the window wearing some type of red clothing. During our investigation, we discovered water dripping from the wall in the bathroom. We were unable to determine if the water leak resulted from the shower being turned on or if damage occurred to the pipes during fire fighting efforts.

I took additional photographs after the body was removed.

I took a total of 205 digital photographs. The digital photographs were later transferred to CD ROM and booked into evidence.

Per Detective Schlesiger, Deputy [REDACTED] and Sgt. Hanson would secure the scene over night. Detective Schlesiger requested HCSO Detective Kirkpatrick, EPD Detective Lawson and I return the following the day to continue processing the scene. I was informed that D.A. Chief Investigator Mike Hislop and D.A. Investigator Wayne Cox would be utilizing a Nikon Total Station to create a diagram of the scene.

I cleared the scene at approximately 1955 hours.

On June 5, 2007 at approximately 0823 hours, I arrived on scene and met with Detectives Kirkpatrick and Lawson. Sgt. Hanson and Deputy [REDACTED] were on scene upon my arrival. At approximately 0827 hours, members of the Humboldt County Arson Task force arrived including HCSO Deputy Diemer. Sgt. Hanson and Deputy [REDACTED] later cleared the scene to conduct witness interviews. Refer to their reports for details.

Using a Nikon digital camera, I proceeded to take photographs. I took photographs of the burnt structure and surrounding area. The front door was located on the north side of the residence. Based on information received from the legal occupant of the residence and the diagrams created on the previous day, the front door opened into the living room area. There was what appeared to be a bedroom on the south side of the living room based on a metal mattress spring observed on the floor. The kitchen area was located on the east side of the living room. There was a hallway, which traveled north from the kitchen to the bathroom and a bedroom. During the initial photographs, we observed what appeared to be a firearm barrel on the living room floor.

I noticed that the walls were completely burnt on the south and east sides of the residence, which contained a bedroom and the kitchen. The roof had fallen into the kitchen area. The additional walls of the residence were still standing with the roof attached.

The two HVTP vehicles were still on scene. We placed the vehicles back into position based on the painted tire marks that were placed on the driveway on the previous day. Per Detectives, the HVTP vehicle with California license plate [REDACTED] was parked closest to the residence and the HVTP vehicle with U.S. Govt plate [REDACTED] was parked directly behind the first vehicle. After placing the vehicles back into position, I took photographs of the vehicles, in a direct line of sight, from the south side of the residence. I was told that this side had contained two windows and it was believed the [REDACTED] had fired his weapon from these windows. Refer to the Detective's report for details. The roofs of the vehicles, including the light bars and front windshields, were clearly visible from this position.

I returned to the vehicles and took photographs. I got inside the both vehicles and took line of sight photographs to the residence. Both vehicles front windshields contained spider web breakage patterns. The second vehicle contained a hole in the hood near and just below the breakage in the front windshield. I noticed damage to the plastic located under the right windshield wiper. The first vehicle contained a hole in the hood near and below the breakage in the front windshield. Upon opening the hood of the first vehicle, I noticed a hole in the rubber gasket at the front of the engine compartment. There was damage to the insulation underneath the hood.

After taking initial photographs, I proceeded to document the scene with video. I took a video of the residence and a video from the intersection of the gravel driveway and Bloody Camp Rd. to the location of the vehicles. The 2 video files were later transferred to DVD and booked into evidence.

We proceeded to place numbered evidence markers on all possible evidence. I took photographs as the evidence was located and marked. I took a video of the location of evidence item #45, which was at the top of the hill on the north side of the residence. The video files were later transferred to DVD and booked into evidence.

I later collected the following items and booked them into evidence:

<u>Item #</u>	<u>Description</u>	<u>Location</u>
4	7 Ferret liquid CS Model SGA-300, 1.5 inch cal. expended cartridges; 5 Ferret liquid CS Model SGA-310, 1.5 inch cal. expended cartridges; 2 Defense Technology No. 17 CS 37/38 mm expended cartridges and 13 Defense Technology No. 40-14 CS 37/40 mm expended cartridges.	Driveway next to HVTP [REDACTED]
7	21 – expended 12 GA shells #230C barricade projectiles	Inside HVTP [REDACTED]
8	6 – expended 12 GA shells #230C barricade projectiles	Driveway next to HVTP [REDACTED]
9	Expended plastic CS projectile	lawn south of house
10	Black plastic 12 GA projectile	lawn south of house
11	Black plastic 12 GA projectile	lawn south of house
12	Black plastic 12 GA projectile	lawn south of house
13	Black plastic 12 GA projectile	lawn below kitchen window
14	Plastic CS projectile	lawn below kitchen window
14a	Canister spoon "MFG 2003"	next to item 14
15	R-P .45 auto expended cartridge case	lawn below kitchen window
16	Metal canister pin	lawn below kitchen window
17	Metal canister pin	lawn below kitchen window
18	Plastic expended CS projectile	east side of house
19	Empty firearm magazine	ground below kitchen
20	Plastic expended CS projectile	east side of house
21	Black plastic expended CS projectile	lawn southwest of house
22	"C" .22 long expended cartridge case	ground near front steps
23	37 mm CS projectile	under vehicle in driveway
24	37 mm CS projectile	lawn north of house
25	"C" .22 long expended cartridge case	lawn north of house
26	37 mm CS projectile	lawn north of house
26a	37 mm CS projectile	in north wall of house
27	37 mm CS projectile	lawn north of house
28	Plastic expended CS projectile	lawn north of house
29	37 mm CS projectile	lawn north of house
30	37 mm CS projectile	lawn north of house
31	37 mm CS projectile	lawn north of house
32	37 mm CS projectile	lawn north of house
33	Plastic CS projectile	lawn north of house
34	.45 auto expended cartridge case	lawn north of house
35	.45 auto expended cartridge case	gravel driveway north/house
36	.45 auto expended cartridge case	gravel driveway north/house
37	.45 auto expended cartridge case	gravel driveway north/house
38	.45 auto expended cartridge case	gravel driveway north/house

<u>Item #</u>	<u>Description</u>	<u>Location</u>
39	37 mm CS projectile	gravel driveway north/house
40	Plastic CS projectile	ground under kitchen floor
41	6 – expended cartridge cases w/ firing pin marks (1 – WW .45 auto & 5 - .223)	ground under kitchen floor
42	Machete blade approx. 17.5 inches long	ground under kitchen floor
43	Spent gas canister	ground under kitchen floor
44	Firearm magazine (empty)	ground under kitchen floor
45	20 – TD 37 mm Ferret expended cartridge cases (2 liquid & 18 powder)	top of hill north of house
46	3 – 37 mm projectiles	in north wall of house
47A	Knife blade approx. 9” x 2.25”	living room floor
47B	Knife blade approx. 5” x 1”	living room floor
47C	Knife (curved) blade approx. 11” x 2”	living room floor
47D	Folding knife in case blade approx. 3.5”	living room floor
47E	Spherical metal ball open holes on both ends (poss. grenade)	living room floor
47F	6 – firearm magazines (empty)	living room floor
47G	Sword in sheath (total length approx. 29”)	living room floor
47H	AK47 Rifle Norinco 7.62mm X09 S/N [REDACTED]	living room floor
47I	Shotgun barrel and tube Mossberg Model 590 12 GA No S/N, bolt carrier, ghost ring sight, shell carrier, magazine spring, magazine, 2 springs	living room floor
47J	AR15 barrel and detached hammer, 22.5”	living room floor
47K	Remington Arms .22 Long Rifle (barrel only) Identifying numbers 20 rt 17	living room floor
47L	Winchester Model 90 .22 Long Rifle S/N [REDACTED] w/ octagon barrel	living room floor
48	Springfield Armory Model 1911 – A1 .45 cal. pistol w/magazine and 7 - .45 auto copper jacketed cartridges [REDACTED]	on top of toilet bathroom
49	Spent gas canister	bedroom southwest corner
50	Plastic CS projectile	bedroom southwest corner
51	Knife: blade approx. 10.5”	ground under kitchen floor
52	Pink pillowcase, red athletic shorts, red Adidas shirt	bathroom
53	.223 LC 06 cartridge	grassy area at intersection driveway and Bloody Camp Rd

While Detective Kirkpatrick, Detective Lawson and I were processing the scene for evidence, D.A. Chief Investigator Mike Hislop and D.A. Investigator Wayne Cox took measurements for a diagram including all of the evidence marked for collection. Refer to their reports for details and diagram.

During the search, I assisted the Arson Task Force with evidence collection and photographs. Refer to Arson Task Force reports for cause and origin determination.

I took a total of 201 digital photographs. The digital photographs were later transferred to CD ROM and booked into evidence.

At approximately 1655 hours, we concluded our search and cleared the scene.

On June 7, 2007, Detective Schlesiger requested I attend the autopsy of [REDACTED] at the Humboldt County Coroner's Office. I arrived at approximately 0932 hours and met with HCSO Detective Kirkpatrick. Also present were EPD Detectives Lawson and Kalis, Deputy Coroner Charles Van Buskirk, Autopsy Technicians [REDACTED] and [REDACTED]. Pathologist Dr. [REDACTED] would be performing the autopsy.

Using a Nikon digital camera, I proceeded to take photographs. I continued to photograph throughout the autopsy. The body was enclosed in a white body bag and a blue body bag with a Humboldt County Coroner's Office identification tag containing the name [REDACTED] Case #C-099-07 and the date 6/4/07.

The autopsy began at approximately 1035 hours. The body was removed from the blue body bag. I proceeded to use an alternative light source to search for possible foreign substances/materials. I noticed three areas of fluorescence on the white body bag. I marked the three areas and took photographs. I swabbed the three areas. The 6 swabs were later booked into evidence. I noticed two areas of fluorescence on the body. I swabbed the right bicep and the right shoulder. The 4 swabs were later booked into evidence. Autopsy Technician [REDACTED] collected head and pubic hair standards. These items were retained by the Coroner's Office. [REDACTED] was wearing no clothing. The Coroner's Office had obtained x-rays of [REDACTED] body. I took photographs of the x-rays. We noticed what appeared to be an old style skeleton key in the x-ray near the pelvic bone.

[REDACTED] began with the external portion of the autopsy. [REDACTED] stated there was a post mortem laceration on the right forearm. [REDACTED] stated there were burns and blisters located on the right arm, right shoulder, the right palm and the left side of the jaw line. [REDACTED] stated the skin was sloughing on the top portion of the right fingers. [REDACTED] stated the top of the left hand and the left palm did not contain any burns or blisters. Refer to [REDACTED] report for details.

At approximately 1100 hours, I proceeded to collect GSR from the right and left thumbs and index fingers. I later booked this item into evidence.

[REDACTED] started the internal portion of the autopsy. [REDACTED] stated there was soot located in the trachea. [REDACTED] stated the cause of death was smoke or heat inhalation. [REDACTED] attempted to locate the key observed on the x-ray with negative results.

The autopsy concluded at approximately 1300 hours.

I took a total of 99 digital photographs. The digital photographs were later transferred to CD ROM and booked into evidence.

On June 7, 2007 at approximately 1420 hours, I examined the tactical vests and equipment collected from Sgt. Quenell, Deputy B. Taylor, Deputy Barney and Deputy Gomes on June 4, 2007. Using a Nikon digital camera, I took photographs during my examination.

Deputy Taylor's vest contained what appeared to be blood on the front of the vest, which contained the Sheriff's logo. Deputy Taylor had informed me that he had injured his nose, during the incident, causing bleeding on the vest. The equipment consisted of a pair of gloves and a wound dressing kit. I did not note any damage or further possible blood on Deputy Taylor's items.

Deputy Barney's equipment consisted of MK-4 spray, 2 magazines with 30 LC 06 cartridges in each magazine. I did not notice any damage or possible blood on Deputy Barney's items.

Sgt. Quenell's equipment consisted of a lens, 2 gloves wound dressing kit, mirror, Streamlight Stinger [REDACTED], radio head set, metal clip, 2 Glock magazines with 15 Winchester .40 S & W cartridges in each magazine, 2 Cal. 5.56 mm Colt magazines with 31 FC 05 cartridges in the first magazine and 17 FC 05 cartridges and 13 LC 06 cartridges in the second magazine. I did not notice any damage or possible blood on Sgt. Quenell's items.

Deputy Gomes' equipment consisted of a tactical vest only. I did not notice any damage or possible blood on Deputy Gomes' vest.

I concluded my examination at approximately 1550 hours. I took a total of 38 digital photographs including 2 photographs of the assignment board located in the HCSO Criminal Investigations Division. The digital photographs were later transferred to CD ROM and booked into evidence.

Per Lt. Cavinta and Detective Schlesiger, these items were returned to the SET members.

On June 8, 2007 at approximately 1020 hours, I examined additional equipment and clothing collected on June 4, 2007 from Sgt. Quenell, Deputy B. Taylor, Deputy Barney and Deputy Gomes. Per Detective Schlesiger, the ammunition examined was not counted. D.A. Chief Investigator Mike Hislop originally documented the ammunition on June 4, 2007. Refer to Hislop's report for details.

Deputy Gomes' equipment and clothing consisted of 2 gloves, a protective mask, 2 knee pads, 2 elbow pads, a headset, a helmet, HCSO SET camouflage shirt size med-regular and a pair of camouflage pants size med-reg. Deputy Gomes' belt contained 2 magazines with ammunition, MK-4 spray and handcuffs. I did not notice any damage or possible blood on Deputy Gomes' items.

Deputy B. Taylor's equipment and clothing consisted of 2 knee pads, 2 elbow pads, a headset, a helmet, camouflage pants size large-regular and camouflage shirt size large regular. Deputy B. Taylor's belt contained 2 handcuffs, MK-4 spray and 4 magazines with ammunition. I noticed a tear in the right side pocket on the shirt and a white residue on both sleeves and left front portion of the shirt. I did not notice any additional damage or possible blood on Deputy B. Taylor's items.

Deputy Barney's equipment and clothing consisted of a helmet, 2 kneepads, 2 elbow pads, HCSO SET camouflage shirt size large-regular and camouflage pants size large-regular. Deputy Barney's belt contained handcuffs. I noticed white residue on the back lower portion of the shirt. I did not notice any damage or possible blood on Deputy Barney's items.

Sgt. Quenell's equipment and clothing consisted of a belt, a helmet, 2 knee pads, 2 black Danner boots size 8 ½, HCSO SET camouflage shirt containing name tag, a pen in the left front pocket and ear plugs in the right front pocket, size med-reg and camouflage pants with black belt and two black gloves in the left side pocket. I did not notice any damage or possible blood on Sgt. Quenell's items.

I concluded my examination at approximately 1400 hours. I took a total of 41 digital photographs. The digital photographs were later transferred to CD ROM and booked into evidence.

Per Lt. Cavinta and Detective Schlesiger, the items were returned to the HCSO SET members.

On June 11, 2007, I examined and photographed the firearm parts and knives collected from the residence on June 5, 2007. HCSO Armory Deputy (RET) John Knife assisted in the firearm parts identifications.

The following are my findings during my examination (measurements are approximate):

- #47A: knife with a blade length of 9 inches and width of 2 ¼ inches, contains no handle, contains fire damage, blade is single edge
- #47B: knife with a blade length of 5 inches and width of 1 inch, serrated edge on top with smooth edge on bottom, metal skeleton of handle in tact, contains fire damage
- #47C: knife with curved single edge blade length of 11 inches and width of 2 inches, handle missing, contains fire damage
- #47D: folding knife in case with a blade length of 3 ½ inches, contains fire damage, unable to open knife
- #47E: hollowed out possible grenade, metal spherical shape object with open holes on both ends (not active)
- #47F: 6 firearm magazines all empty, contains fire damage
- #47G: sword in sheath with handle missing, total length is 29 inches, contains fire damage
- #47H: AK47 Rifle S/N [REDACTED] Norinco Made in China 7.62 mm X09, safety in "F" (fire) position, stock melted, contains fire damage

- #47I: Shotgun barrel and tube only, total length 23 ¾ inches long, Mossberg Model 590 12 GA 20 inch cylinder bore no S/N, contains fire damage
- #47J: AR15 barrel with detached hammer, barrel length 22 ½ inches, total length 29 ½ inches, no identifiable marks, contains fire damage
- #47K: .22 long rifle Remington Arms ?S/N 20 RT 17, total length 25 inches, barrel length 20 inches, 2 bored holes near chamber and 1 bored hole near end of rifle barrel
- #47L: Winchester Model 90 .22 long rifle with missing stock, octagon barrel 23 ½ inches, S/N [REDACTED]

I took a total of 51 digital photographs. The digital photographs were later transferred to CD ROM and booked into evidence.

On June 12, 2007 at approximately 0800 hours, I received a metal lighter from HCSO Deputy Diemer. Deputy Diemer informed me this item had been recovered from the residence on June 5, 2007. I later booked this item into evidence.

On June 12, 2007 at approximately 1340 hours, I received 4 Colt M16 rifles and 3 pairs of boots from D.A. Chief Investigator Mike Hislop. I was informed the boots had been securely stored in D.A. Investigator Honsal's Office and the M16 rifles had been securely stored in the D.A. Office Evidence Room. Hislop had originally collected the rifles and boots from Sgt. Quenell, Deputy B. Taylor, Deputy Barney and Deputy Gomes on June 4, 2007.

I met with D.A. Investigator Steve Dunn to perform examinations on the rifles. All weapons were received loaded with the safety in the on position. Using a Nikon digital camera, I took photographs during the examination.

Sgt. Bryan Quenell: Colt M16 A2 Cal. 5.56mm S/N [REDACTED] with magazine, tactical light, Trijicon sight and straps; 1 LC06 cartridge in chamber and 17 LC 06 cartridges in magazine

Deputy Jamie Barney: Colt M16 A2 Cal. 5.56mm S/N [REDACTED] with magazine, tactical light, Trijicon sight, Colt grenade launcher (empty) S/N [REDACTED] 40mm M203; 1 LC 06 cartridge in chamber and 27 LC 06 cartridges in magazine.

Deputy Anthony Gomes: Colt M16 A2 Cal 5.56mm S/N [REDACTED] with magazine, tactical light, no scope; 1 LC 06 cartridge in chamber and 27 LC 06 cartridges in magazine.

Deputy Brian Taylor: Colt M16 A2 Cal. 5.56mm S/N [REDACTED] with magazine, tactical light, scope Trijicon; 1 FC 05 cartridge in chamber and 16 FC 05 cartridges in magazine.

I took a total of 34 digital photographs. The digital photographs were later transferred to CD ROM and booked into evidence. I later booked the 4 Colt M16 rifles into evidence at the HCSO Evidence Storage Facility.

After performing examinations on the rifles, I retrieved the blood samples for Sgt. Quenell, Deputy B. Taylor, Deputy Barney and Deputy Gomes from the Evidence Refrigerator located in the HCSO Criminal Investigations Division. The blood samples had originally been collected by D.A. Chief Investigator Mike Hislop. Refer to Hislop's report for details. I booked the four blood samples into evidence. I took 6 digital photographs of the blood samples. The digital photographs were later transferred to CD ROM and booked into evidence.

On June 18, 2007 I performed an examination on the boots I received from D.A. Chief Investigator Mike Hislop on June 12, 2007. I took photographs of the boots during my examination.

Deputy Gomes: black Bates boots, size 10 ½
Deputy Barney: black Danner boots, size 10 ½
Deputy Taylor: black Danner boots, unknown size

I did not notice any damage or possible blood on the boots. At approximately 0915 hours, the boots were released to Lt. Cavinta to be given to the HCSO SET members.

I took a total of 6 digital photographs. The digital photographs were later transferred to CD ROM and booked into evidence.

On June 18, 2007, I completed my examination of the weapons collected from the residence on June 5, 2007. I took digital photographs during my examination. All measurements are approximate.

#51: knife from kitchen area, blade length 10 ½ inches, serrated on top, sharp on the bottom, total length 16 inches, contains fire damage
#48: Springfield Armory [REDACTED] Model 1911 - A1 .45 caliber (chamber empty), magazine contains 7 *I* .45 auto copper jacketed cartridges

I took a total of 5 digital photographs. The digital photographs were later transferred to CD ROM and booked into evidence.

I will request a copy of this report be forwarded to Detective Schlesiger.

Any further investigation will be a matter of report.

[REDACTED]

6/3/08
Date

Approved

**HUMBOLDT COUNTY SHERIFF'S OFFICE
PROPERTY/EVIDENCE BOOKING AND RELEASE REPORT**

CASE NUMBER: 200703162

PAGE _____ OF _____

DATE STORED <u>6-4-07</u>	TIME STORED <u>1510</u>	DATE OF INCIDENT <u>6-3-07</u>	CRIME <u>PC 1604/187</u>
NAME OF FINDER (ADDITIONAL VICTIM) <u>STATE OF CA</u>	DOB	ADDRESS	PHONE
LOCATION PROPERTY WAS FOUND (INCIDENT OCCURRED) <u>MASTEN FLATS, HOOPA, CA</u>	DOB	ADDRESS <u>[REDACTED]</u>	PHONE <u>RESIDENCE</u>

ADULT ARREST
 JUVENILE ARREST
 SEARCH WARRANT NO. _____

TYPE OF PROPERTY

EVIDENCE FOUND SAFEKEEPING

PROPERTY CODES *178

S - Stolen	D - Damaged
R - Recovered	L - Lost
RA - Recovered (For Other Agency)	E - Evidence
F - Found	K - Safekeeping
	C - Contraband

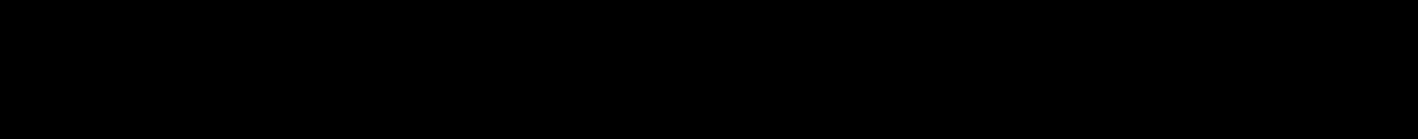

PROPERTY/EVIDENCE LISTING

CODE	ITEM NO.	QTY.	DESCRIPTION	VALUE	NCIC	WEIGHT	DISPOSITION
<u>E</u>	<u>1</u>	<u>7</u>	[REDACTED]				
<u>E</u>	<u>2</u>	<u>MISC</u>	<u>INDICIA: [REDACTED]</u>				
<u>E</u>	<u>3</u>	<u>MISC</u>	<u>4 SUPER X CARTRIDGES; 1 - .44 REM MAG CARTRIDGE; 3 - WIN .380 AUTO CARTRIDGES; 3 - .22 LONG CARTRIDGES; 2 - 20 GA SHOTGUN SHELLS</u>				
<u>E</u>	<u>4</u>	<u>MISC</u>	<u>INDICIA: [REDACTED]</u>				

OWNERS OF PROPERTY

ITEMS NO.	NAME	DOB	ADDRESS	PHONE	NOTIFIED

LAB WORK REQUIRED

ITEMS NO.	PURPOSE OF EXAM

[REDACTED]	PIN <u>1302</u>	REPORT DATE <u>6-12-07</u>	SUPERVISOR REVIEW _____	PIN _____	REPORT DATE _____
------------	-----------------	----------------------------	-------------------------	-----------	-------------------

CASE FILE COPY

**HUMBOLDT COUNTY SHERIFF'S OFFICE
PROPERTY/EVIDENCE BOOKING AND RELEASE REPORT**

CASE NUMBER: 200703162

PAGE _____ OF _____

DATE STORED 6-5-07	TIME STORED 1700	DATE OF INCIDENT 6-4-07	CRIME PC 604(E)/187
NAME OF FINDER (ADDITIONAL VICTIM) STATE OF CA		DOB	ADDRESS [REDACTED]
NAME OF FINDER (ADDITIONAL VICTIM)		DOB	ADDRESS [REDACTED]
LOCATION PROPERTY WAS FOUND (INCIDENT OCCURRED) BLOODY CAMP RD. HOOPA [REDACTED] RESIDENCE			

ADULT ARREST
 JUVENILE ARREST
 SEARCH WARRANT NO. 6304

TYPE OF PROPERTY
 EVIDENCE FOUND SAFEKEEPING

PROPERTY CODES *178

S - Stolen	D - Damaged
R - Recovered	L - Lost
RA - Recovered (For Other Agency)	E - Evidence
F - Found	K - Safekeeping
	C - Contraband

PROPERTY/EVIDENCE LISTING

CODE	ITEM NO.	QTY.	DESCRIPTION	VALUE	NCIC	WEIGHT	DISPOSITION
E	1	1	.223 EXPENDED CARTRIDGE CASE				
E	2	1	.223 EXPENDED CARTRIDGE CASE				
E	3	1	.223 EXPENDED CARTRIDGE CASE				
E	4	27	EXPENDED CS CARTRIDGES: 7 FERRET LIQUID CS MODEL SGA-300 CAL 1 1/2 INCH; 5 FERRET LIQUID CS MODEL SGA-310 CAL 1 1/2 INCH; 2 DEFENSE TECHNOLOGY ND. 17 CS 37/38mm; 13 DEFENSE TECHNOLOGY ND. 40-14 CS 37/40mm				
E	5	1	EXPENDED 9mm SIMS ROUND				
E	6	1	.223 EXPENDED CARTRIDGE CASE WINCHESTER REM				
E	7	21	EXPENDED 12 GA. SHELLS # 230C BARRICADE PROJECTILES				
E	8	6	EXPENDED 12 GA. SHELLS # 230C BARRICADE PROJECTILES				
E	9	1	PLASTIC CS PROJECTILE EXPENDED				
E	10	1	BLACK PLASTIC 12 GA. PROJECTILE				

OWNERS OF PROPERTY

ITEMS NO.	NAME	DOB	ADDRESS	PHONE	NOTIFIED
ITEMS NO.	NAME	DOB	ADDRESS	PHONE	NOTIFIED
ITEMS NO.	NAME	DOB	ADDRESS	PHONE	NOTIFIED

LAB WORK REQUIRED

ITEMS NO.	PURPOSE OF EXAM
ITEMS NO.	PURPOSE OF EXAM
ITEMS NO.	PURPOSE OF EXAM

PIN 1302	REPORT DATE 6-26-07	SUPERVISOR REVIEW	PIN	REPORT DATE
----------	---------------------	-------------------	-----	-------------

CASE .E COPY

**HUMBOLDT COUNTY SHERIFF'S OFFICE
PROPERTY/EVIDENCE BOOKING AND RELEASE REPORT**

CASE NUMBER: 200703162

PAGE _____ OF _____

DATE STORED 6-5-07	TIME STORED 1700	DATE OF INCIDENT 6-4-07	CRIME PC 664(E)/187
NAME OF FINDER (ADDITIONAL VICTIM) STATE OF CA		DOB	ADDRESS
NAME OF FINDER (ADDITIONAL VICTIM)		DOB	ADDRESS
LOCATION PROPERTY WAS FOUND (INCIDENT OCCURRED) BLOODY CAMP RD HOOPA RESIDENCE			

ADULT ARREST
 JUVENILE ARREST
 SEARCH WARRANT NO. 6304

TYPE OF PROPERTY
 EVIDENCE FOUND SAFEKEEPING

PROPERTY CODES *178

S - Stolen	D - Damaged
R - Recovered	L - Lost
RA - Recovered (For Other Agency)	E - Evidence
F - Found	K - Safekeeping
	C - Contraband

PROPERTY/EVIDENCE LISTING

CODE	ITEM NO.	QTY.	DESCRIPTION	VALUE	NCIC	WEIGHT	DISPOSITION
E	11	1	BLACK PLASTIC 12 GA. PROJECTILE				
E	12	1	BLACK PLASTIC 12 GA. PROJECTILE				
E	13	1	BLACK PLASTIC 12 GA. PROJECTILE				
E	14	1	PLASTIC CS PROJECTILE				
E	14A	1	CANNISTER SPOON "MFG 2003"				
E	15	1	R.P. 45 AUTO EXPENDED CARTRIDGE CASE				
E	16	1	METAL CANNISTER PIN				
E	17	1	METAL CANNISTER PIN				
E	18	1	PLASTIC CS PROJECTILE EXPENDED				
E	19	1	EMPTY FIREARM MAGAZINE				
E	20	1	PLASTIC EXPENDED CS PROJECTILE				
E	21	1	BLACK PLASTIC CS PROJECTILE EXPENDED				

OWNERS OF PROPERTY

ITEMS NO.	NAME	DOB	ADDRESS	PHONE	NOTIFIED
ITEMS NO.	NAME	DOB	ADDRESS	PHONE	NOTIFIED
ITEMS NO.	NAME	DOB	ADDRESS	PHONE	NOTIFIED

LAB WORK REQUIRED

ITEMS NO.	PURPOSE OF EXAM
ITEMS NO.	PURPOSE OF EXAM
ITEMS NO.	PURPOSE OF EXAM

PIN 1302	REPORT DATE 6-26-07	SUPERVISOR REVIEW	PIN	REPORT DATE
-------------	------------------------	-------------------	-----	-------------

CASUALTY COPY

HUMBOLDT COUNTY SHERIFF'S OFFICE
PROPERTY/EVIDENCE BOOKING AND RELEASE REPORT

CASE NUMBER: 200703162

PAGE _____ OF _____

DATE STORED 6-5-07	TIME STORED 1700	DATE OF INCIDENT 6-4-07	CRIME PC 664(E)/187
STATE OF CA		DOB	ADDRESS
NAME OF FINDER (ADDITIONAL VICTIM)		DOB	ADDRESS
LOCATION PROPERTY WAS FOUND (INCIDENT OCCURRED)		RESIDENCE	

ADULT ARREST
 JUVENILE ARREST
 SEARCH WARRANT NO. 6304

TYPE OF PROPERTY
 EVIDENCE FOUND SAFEKEEPING

PROPERTY CODES *178

S - Stolen	D - Damaged
R - Recovered	L - Lost
RA - Recovered (For Other Agency)	E - Evidence
F - Found	K - Safekeeping
	C - Contraband

CODE	ITEM NO.	QTY.	DESCRIPTION	VALUE	NCIC	WEIGHT	DISPOSITION
E	22	1	"C" .22 LONG EXPENDED CARTRIDGE CASE				
E	23	1	37mm CS PROJECTILE				(IN CAN)
E	24	1	37mm CS PROJECTILE				(IN CAN)
E	25	1	.22 "C" EXPENDED CARTRIDGE CASE				(IN CAN)
E	26	1	37mm CS PROJECTILE				(IN CAN)
E	27	1	37mm CS PROJECTILE				(IN CAN)
E	26A	1	37mm CS PROJECTILE				(IN CAN)
E	28	1	PLASTIC CS PROJECTILE EXPENDED				(IN CAN)
E	29	1	37mm CS PROJECTILE				(IN CAN)
	30	1	37mm CS PROJECTILE				(IN CAN)
	31	1	37mm CS PROJECTILE				(IN CAN)
	32	1	37mm CS PROJECTILE				(IN CAN)

OWNERS OF PROPERTY

ITEMS NO.	NAME	DOB	ADDRESS	PHONE	NOTIFIED

LAB WORK REQUIRED

ITEMS NO.	PURPOSE OF EXAM

BC	PIN 1302	REPORT DATE 6-26-07	SUPERVISOR REVIEW	PIN	REPORT DATE
----	----------	---------------------	-------------------	-----	-------------

CASL E COPY

**HUMBOLDT COUNTY SHERIFF'S OFFICE
PROPERTY/EVIDENCE BOOKING AND RELEASE REPORT**

CASE NUMBER: 200703162

PAGE _____ OF _____

DATE STORED 6-5-07	TIME STORED 1700	DATE OF INCIDENT 6-4-07	CRIME PC (604E)/187
STATE OF CA		DOB	ADDRESS
NAME OF FINDER (ADDITIONAL VICTIM)		DOB	ADDRESS
LOCATION PROPERTY WAS FOUND (INCIDENT OCCURRED) BLOODY CAMP RD HOOPA		RESIDENCE	

ADULT ARREST
 JUVENILE ARREST
 SEARCH WARRANT NO. 6304

TYPE OF PROPERTY
 EVIDENCE FOUND SAFEKEEPING

PROPERTY CODES *178

S - Stolen	D - Damaged
R - Recovered	L - Lost
RA - Recovered (For Other Agency)	E - Evidence
F - Found	K - Safekeeping
	C - Contraband

PROPERTY/EVIDENCE LISTING

CODE	ITEM NO.	QTY.	DESCRIPTION	VALUE	NCIC	WEIGHT	DISPOSITION
E	33	1	PLASTIC CS PROJECTILE				
E	34	1	.45 AUTO EXPENDED CARTRIDGE CASE				
E	35	1	.45 AUTO EXPENDED CARTRIDGE CASE				
E	36	1	.45 AUTO EXPENDED CARTRIDGE CASE				
E	37	1	.45 AUTO EXPENDED CARTRIDGE CASE				
E	38	1	.45 AUTO EXPENDED CARTRIDGE CASE				
E	39	1	37mm CS PROJECTILE				(IN CAN)
E	40	1	PLASTIC CS PROJECTILE				
E	41	6	EXPENDED CARTRIDGE CASES W/ FIRING PIN MARKS 1-WW .45 AUTO			5-	.223
E	42	1	MACHETE BLADE APPROX 17 1/2 INCHES				
E	43	1	SPENT GAS CANNISTER				
E	44	1	FIREARM MAGAZINE (EMPTY)				

OWNERS OF PROPERTY

ITEMS NO.	NAME	DOB	ADDRESS	PHONE	NOTIFIED
ITEMS NO.	NAME	DOB	ADDRESS	PHONE	NOTIFIED
ITEMS NO.	NAME	DOB	ADDRESS	PHONE	NOTIFIED

LAB WORK REQUIRED

ITEMS NO.	PURPOSE OF EXAM
ITEMS NO.	PURPOSE OF EXAM
ITEMS NO.	PURPOSE OF EXAM

PIN 1302	REPORT DATE 6-26-07	SUPERVISOR REVIEW	PIN	REPORT DATE
----------	---------------------	-------------------	-----	-------------

CASI E COPY

**HUMBOLDT COUNTY SHERIFF'S OFFICE
PROPERTY/EVIDENCE BOOKING AND RELEASE REPORT**

CASE NUMBER: 200703162

PAGE _____ OF _____

DATE STORED <u>6-5-07</u>	TIME STORED <u>1700</u>	DATE OF INCIDENT <u>6-4-07</u>	CRIME <u>PC 664(E)/187</u>
[REDACTED]		DOB	ADDRESS
STATE OF CA		DOB	ADDRESS
NAME OF FINDER (ADDITIONAL VICTIM)		DOB	ADDRESS
LOCATION PROPERTY WAS FOUND (INCIDENT OCCURRED) <u>BLOODY CAMP RD HOOPA</u>		[REDACTED] <u>RESIDENCE</u>	

ADULT ARREST
 JUVENILE ARREST
 SEARCH WARRANT NO. 6304

TYPE OF PROPERTY
 EVIDENCE FOUND SAFEKEEPING

PROPERTY CODES *178

S - Stolen	D - Damaged
R - Recovered	L - Lost
RA - Recovered (For Other Agency)	E - Evidence
F - Found	K - Safekeeping
	C - Contraband

PROPERTY/EVIDENCE LISTING

CODE	ITEM NO.	QTY.	DESCRIPTION	VALUE	NCIC	WEIGHT	DISPOSITION
E	45	20	TD 37mm FERRET EXPENDED CARTRIDGE CASES	(2 LIDUO		18	POWDER)
E	46	3	37mm CS PROJECTILES (REMOVED FROM NORTH WALL)				(IN CAN)
E			47 + 48 SEE ADDITIONAL EVIDENCE SHEETS				
E	49	1	SPENT GAS CANNISTER				
E	50	1	PLASTIC CS PROJECTILE				(IN CAN)
E	51	1	KNIFE BLADE APPROX 10 1/2" LONG				
E	52	3	PINK PILLOW CASE, RED ATHLETIC SHORTS, RED ADIDAS SHIRT				
E	53	1	.223 LC 06 CARTRIDGE				- GRASSY AREA BEHIND COMM. VAN

OWNERS OF PROPERTY

ITEMS NO.	NAME	DOB	ADDRESS	PHONE	NOTIFIED
ITEMS NO.	NAME	DOB	ADDRESS	PHONE	NOTIFIED
ITEMS NO.	NAME	DOB	ADDRESS	PHONE	NOTIFIED

LAB WORK REQUIRED

ITEMS NO.	PURPOSE OF EXAM
ITEMS NO.	PURPOSE OF EXAM
ITEMS NO.	PURPOSE OF EXAM

PIN 1302 REPORT DATE 6-26-07 SUPERVISOR REVIEW _____ PIN _____ REPORT DATE _____

CASI E COPY

**HUMBOLDT COUNTY SHERIFF'S OFFICE
PROPERTY/EVIDENCE BOOKING AND RELEASE REPORT**

CASE NUMBER: 200703162

PAGE _____ OF _____

DATE STORED 6-5-07	TIME STORED 1700	DATE OF INCIDENT 6-4-07	CRIME PC 664(e)/187
NAME OF FINDER (ADDITIONAL VICTIM) STATE OF CA		DOB	ADDRESS
NAME OF FINDER (ADDITIONAL VICTIM)		DOB	ADDRESS
LOCATION PROPERTY WAS FOUND (INCIDENT OCCURRED) BLOODY CAMP RD HOOPA RESIDENCE			

ADULT ARREST
 JUVENILE ARREST
 SEARCH WARRANT NO. _____

TYPE OF PROPERTY
 EVIDENCE FOUND SAFEKEEPING

PROPERTY CODES *178

S - Stolen	D - Damaged
R - Recovered	L - Lost
RA - Recovered (For Other Agency)	E - Evidence
F - Found	K - Safekeeping
	C - Contraband

PROPERTY/EVIDENCE LISTING

CODE	ITEM NO.	QTY.	DESCRIPTION	VALUE	NCIC	WEIGHT	DISPOSITION
E	47A	1	KNIFE BLADE ~ 9" WIDTH ~ 2 1/4" -				LIVING ROOM
E	47B	1	KNIFE BLADE ~ 5" WIDTH ~ 1" -				LIVING ROOM
E	47C	1	KNIFE CURVED BLADE ~ 11" WIDTH ~ 2" -				LIVING ROOM
E	47D	1	FOLDING KNIFE IN CASE BLADE ~ 3 1/2" -				LIVING ROOM
E	47E	1	SPHERICAL METAL BALL OPEN HOLES ON BOTH ENDS (POSS. GRENADE)				LIVING ROOM
E	47F	6	FIREARM MAGAZINES (EMPTY)				LIVING ROOM
E	47G	1	SWORD IN SHEATH TOTAL LENGTH ~ 29"				LIVING ROOM
E	47H	1	AK47 RIFLE NORINCO 7.62mm X09 [REDACTED] MADE IN CHINA				LIVING ROOM
E	47I	1	SHOTGUN BARREL & TUBE MOSSBERG MODEL 590 12 GA. NOS/N BOLT CARRIER, GHOST RING SIGHT, SHELL CARRIER, MAGAZINE SPRING, MAGAZINE, 2 SPRINGS-LR.				LIVING ROOM
E	47J	1	AR15 BARREL & HAMMER (DETACHED) BARREL 22 1/2"				LIVING ROOM
E	47K	1	REMINGTON ARMS .22 LONG RIFLE (BARREL ONLY) ?S/N 20 RT 17				LIVING ROOM

OWNERS OF PROPERTY

ITEMS NO.	NAME	DOB	ADDRESS	PHONE	NOTIFIED
ITEMS NO.	NAME	DOB	ADDRESS	PHONE	NOTIFIED
ITEMS NO.	NAME	DOB	ADDRESS	PHONE	NOTIFIED

LAB WORK REQUIRED

ITEMS NO.	PURPOSE OF EXAM
ITEMS NO.	PURPOSE OF EXAM
ITEMS NO.	PURPOSE OF EXAM

PIN 1302	REPORT DATE 6-18-07	SUPERVISOR REVIEW	PIN	REPORT DATE
-------------	------------------------	-------------------	-----	-------------

CAS E COPY

**HUMBOLDT COUNTY SHERIFF'S OFFICE
PROPERTY/EVIDENCE BOOKING AND RELEASE REPORT**

CASE NUMBER: 200703162

PAGE _____ OF _____

DATE STORED 6-5-07	TIME STORED 1700	DATE OF INCIDENT 6-4-07	CRIME PC 664(e)1187
STATE OF CA		DOB	ADDRESS
NAME OF FINDER (ADDITIONAL VICTIM)		DOB	ADDRESS
LOCATION PROPERTY WAS FOUND (INCIDENT OCCURRED) BLOODY CAMP RD HOOPA RESIDENCE			

ADULT ARREST
 JUVENILE ARREST
 SEARCH WARRANT NO.

TYPE OF PROPERTY
 EVIDENCE FOUND SAFEKEEPING

PROPERTY CODES *178

S - Stolen	D - Damaged
R - Recovered	L - Lost
RA - Recovered (For Other Agency)	E - Evidence
F - Found	K - Safekeeping
	C - Contraband

PROPERTY/EVIDENCE LISTING

CODE	ITEM NO.	QTY.	DESCRIPTION	VALUE	NCIC	WEIGHT	DISPOSITION
E	47L	1	WINCHESTER MODEL 90 .22 LONG RIFLE				OCTAGON BARREL - L.R.
E	48	1	SPRINGFIELD ARMORY MODEL 1911-A1 .45 CALIBER PISTOL W/ MAGAZINE AND 7 .45 AUTO COPPER JACKET CARTRIDGES N/A				BATHROOM

OWNERS OF PROPERTY

ITEMS NO.	NAME	DOB	ADDRESS	PHONE	NOTIFIED

LAB WORK REQUIRED

ITEMS NO.	PURPOSE OF EXAM

BO	PIN	REPORT DATE	SUPERVISOR REVIEW	PIN	REPORT DATE
	1302	6-18-07			

CASE E COPY

**HUMBOLDT COUNTY SHERIFF'S OFFICE
PROPERTY/EVIDENCE BOOKING AND RELEASE REPORT**

CASE NUMBER: 200703162

PAGE _____ OF _____

DATE STORED 6-7-07	TIME STORED 1300	DATE OF INCIDENT 6-4-07	CRIME PC 1604/187
STATE OF CA NAME OF FINDER (ADDITIONAL VICTIM)	DOB	ADDRESS	PHONE
LOCATION PROPERTY WAS FOUND (INCIDENT OCCURRED) HUMBOLDT CO. CORONER'S OFFICE - AUTOPSY	DOB	ADDRESS	PHONE

ADULT ARREST
 JUVENILE ARREST
 SEARCH WARRANT NO. _____

TYPE OF PROPERTY

EVIDENCE
 FOUND
 SAFEKEEPING

PROPERTY CODES *178

S - Stolen	D - Damaged
R - Recovered	L - Lost
RA - Recovered (For Other Agency)	E - Evidence
F - Found	K - Safekeeping
	C - Contraband

CODE	ITEM NO.	QTY.	DESCRIPTION	VALUE	NCIC	WEIGHT	DISPOSITION
E	1	2	SWABS: INTERIOR OF WHITE BODY BAG				
E	2	2	SWABS: INTERIOR OF WHITE BODY BAG				
E	3	2	SWABS: INTERIOR OF WHITE BODY BAG				
E	4	2	SWABS: RIGHT BICEP				
E	5	2	SWABS: RIGHT SHOULDER				
E	6	1	GSR: RIGHT + LEFT HANDS				

OWNERS OF PROPERTY

ITEMS NO.	NAME	DOB	ADDRESS	PHONE	NOTIFIED

LAB WORK REQUIRED

ITEMS NO.	PURPOSE OF EXAM

PIN 1302	REPORT DATE 6-12-07	SUPERVISOR REVIEW	PIN	REPORT DATE
-------------	------------------------	-------------------	-----	-------------

CAS LE COPY

**HUMBOLDT COUNTY SHERIFF'S OFFICE
PROPERTY/EVIDENCE BOOKING AND RELEASE REPORT**

CASE NUMBER: 200703162

PAGE _____ OF _____

DATE STORED 6-12-07	TIME STORED 1340	DATE OF INCIDENT 6-4-07	CRIME PC 664/187
NAME OF FINDER (ADDITIONAL VICTIM) STATE OF CA		DOB	ADDRESS
NAME OF FINDER (ADDITIONAL VICTIM)		DOB	ADDRESS
LOCATION PROPERTY WAS FOUND (INCIDENT OCCURRED) PINE CREEK / BLOODY CAMP RD, HOOPA			

ADULT ARREST
 JUVENILE ARREST
 SEARCH WARRANT NO. _____

TYPE OF PROPERTY
 EVIDENCE FOUND SAFEKEEPING

PROPERTY CODES *178

S - Stolen	D - Damaged
R - Recovered	L - Lost
RA - Recovered (For Other Agency)	E - Evidence
F - Found	K - Safekeeping
	C - Contraband

PROPERTY/EVIDENCE LISTING

CODE	ITEM NO.	QTY.	DESCRIPTION	VALUE	NCIC	WEIGHT	DISPOSITION
E	1	1	COLT M16 A2 5.56mm RIFLE S/N [REDACTED] (BRYAN DUENELL)				w/
			MAGAZINE & 18 LC 06 CARTRIDGES CAL. 223				
E	2	1	COLT M16 A2 5.56mm RIFLE S/N [REDACTED] (JAMIE BARNEY)				w/
			MAGAZINE & 28 LC 06 CARTRIDGES CAL. 223, COLT GRENADE LAUNCHER S/N [REDACTED] 40mm M203				
E	3	1	COLT M16 A2 5.56mm RIFLE S/N [REDACTED] (ANTHONY GOMES)				w/
			MAGAZINE & 28 LC 06 CARTRIDGES CAL. 223				
F	4	1	COLT M16 A2 5.56mm RIFLE S/N [REDACTED] (BRIAN TAYLOR)				w/
			MAGAZINE & 17 FC 05 CARTRIDGES CAL. 223				
E	5	34	DIGITAL PHOTOGRAPHS TRANSFERRED TO CD ROM				

OWNERS OF PROPERTY

ITEMS NO.	NAME	DOB	ADDRESS	PHONE	NOTIFIED

LAB WORK REQUIRED

ITEMS NO.	PURPOSE OF EXAM
ITEMS NO.	PURPOSE OF EXAM
ITEMS NO.	PURPOSE OF EXAM

PIN 1302	REPORT DATE 6-15-07	SUPERVISOR REVIEW	PIN	REPORT DATE
-------------	------------------------	-------------------	-----	-------------

CASE COPY

**HUMBOLDT COUNTY SHERIFF'S OFFICE
PROPERTY/EVIDENCE BOOKING AND RELEASE REPORT**

CASE NUMBER: 200703162

PAGE _____ OF _____

DATE STORED 6-12-07	TIME STORED 1400	DATE OF INCIDENT 6-4-07	CRIME PC 664(E)187
NAME OF FINDER (ADDITIONAL VICTIM) STATE OF CA		DOB	ADDRESS
NAME OF FINDER (ADDITIONAL VICTIM)		DOB	ADDRESS
LOCATION PROPERTY WAS FOUND (INCIDENT OCCURRED)			

ADULT ARREST
 JUVENILE ARREST
 SEARCH WARRANT NO. _____

TYPE OF PROPERTY

EVIDENCE
 FOUND
 SAFEKEEPING

PROPERTY CODES *178

S - Stolen	D - Damaged
R - Recovered	L - Lost
RA - Recovered (For Other Agency)	E - Evidence
F - Found	K - Safekeeping
	C - Contraband

PROPERTY/EVIDENCE LISTING

CODE	ITEM NO.	QTY.	DESCRIPTION	VALUE	NCIC	WEIGHT	DISPOSITION
E	1	MISC	BLOOD SAMPLE: DEPUTY ANTHONY EDMES				
E	2	MISC	BLOOD SAMPLE: DEPUTY JAMIE BARNEY				
E	3	MISC	BLOOD SAMPLE: DEPUTY BRIAN TAYLOR				
E	4	MISC	BLOOD SAMPLE: SGT. BRYAN QUENELL				
COLLECTED BY DA. CHIEF INV. MIKE HISLOP RETRIEVED FROM C.I.D. EVIDENCE REFRIG.							

OWNERS OF PROPERTY

ITEMS NO.	NAME	DOB	ADDRESS	PHONE	NOTIFIED
ITEMS NO.	NAME	DOB	ADDRESS	PHONE	NOTIFIED
ITEMS NO.	NAME	DOB	ADDRESS	PHONE	NOTIFIED

LAB WORK REQUIRED

ITEMS NO.	PURPOSE OF EXAM
ITEMS NO.	PURPOSE OF EXAM
ITEMS NO.	PURPOSE OF EXAM

PIN 1302	REPORT DATE 6-12-07	SUPERVISOR REVIEW	PIN	REPORT DATE
-------------	------------------------	-------------------	-----	-------------

CASE COPY

HUMBOLDT COUNTY SHERIFF'S OFFICE
PROPERTY/EVIDENCE BOOKING AND RELEASE REPORT

CASE NUMBER: 200703162

PAGE _____ OF _____

DATE STORED SEE BELOW	TIME STORED	DATE OF INCIDENT 6-3-07	CRIME PC 664/187
NAME OF FINDER (ADDITIONAL VICTIM) STATE OF CA		DOB	ADDRESS
LOCATION PROPERTY WAS FOUND (INCIDENT OCCURRED) BLOODY CAMP RD, HOOPA CA		DOB	ADDRESS

ADULT ARREST
 JUVENILE ARREST
 SEARCH WARRANT NO.

TYPE OF PROPERTY
 EVIDENCE FOUND SAFEKEEPING

PROPERTY CODES *178

S - Stolen	D - Damaged
R - Recovered	L - Lost
RA - Recovered (For Other Agency)	E - Evidence
F - Found	K - Safekeeping
	C - Contraband

PROPERTY/EVIDENCE LISTING

CODE	ITEM NO.	QTY.	DESCRIPTION	VALUE	NCIC	WEIGHT	DISPOSITION
E	1	205	DIGITAL PHOTOGRAPHS TRANSF. TO CD ROM 6-4-07 SCENE/RESIDENCE				
E	2	1	VIDEO FILE TRANSF. TO DVD 6-4-07 RESIDENCE				
E	3	8	VIDEO FILES TRANSF. TO DVD 6-4-07 SCENE/FIRE				
E	4	201	DIGITAL PHOTOGRAPHS TRANSF. TO CD ROM 6-5-07 SCENE				
E	5	3	VIDEO FILES TRANSF. TO DVD 6-5-07 SCENE				
E	6	99	DIGITAL PHOTOGRAPHS TRANSF. TO CD ROM 6-7-07 AUTOPSY				
E	7	38	DIGITAL PHOTOGRAPHS TRANSF. TO CD ROM 6-7-07 SET EQUIPMENT				
E	8	41	DIGITAL PHOTOGRAPHS TRANSF. TO CD ROM 6-8-07 SET EQUIPMENT				
E	9	51	DIGITAL PHOTOGRAPHS TRANSF. TO CD ROM 6-11-07 RECOVERED EVIDENCE				
E	10	46	DIGITAL PHOTOGRAPHS TRANSF. TO CD ROM 6-12-07 SET WEAPONS/BOOTS				
E	11	5	DIGITAL PHOTOGRAPHS TRANSF. TO CD ROM 6-18-07 RECOVERED EVIDENCE				

OWNERS OF PROPERTY

ITEMS NO.	NAME	DOB	ADDRESS	PHONE	NOTIFIED

LAB WORK REQUIRED

ITEMS NO.	PURPOSE OF EXAM

PIN 1302	REPORT DATE 6-18-07	SUPERVISOR REVIEW	PIN	REPORT DATE
-------------	------------------------	-------------------	-----	-------------

CAS. .LE COPY

**HUMBOLDT COUNTY SHERIFF'S OFFICE
PROPERTY/EVIDENCE BOOKING AND RELEASE REPORT**

CASE NUMBER: 200703162

PAGE _____ OF _____

DATE STORED 6-12-07	TIME STORED 0800	DATE OF INCIDENT 6-3-07	CRIME PC 664/187
NAME OF FINDER (ADDITIONAL VICTIM) STATE OF CA		DOB	ADDRESS
NAME OF FINDER (ADDITIONAL VICTIM)		DOB	ADDRESS
LOCATION PROPERTY WAS FOUND (INCIDENT OCCURRED) BLOODY CAMP RD, HOOPA CA			

ADULT ARREST
 JUVENILE ARREST
 SEARCH WARRANT NO. _____

TYPE OF PROPERTY

EVIDENCE
 FOUND
 SAFEKEEPING

PROPERTY CODES *178

S - Stolen	D - Damaged
R - Recovered	L - Lost
RA - Recovered (For Other Agency)	E - Evidence
F - Found	K - Safekeeping
	C - Contraband

PROPERTY/EVIDENCE LISTING

CODE	ITEM NO.	QTY.	DESCRIPTION	VALUE	NCIC	WEIGHT	DISPOSITION
E	1	1	METAL LIGHTER				
			RECEIVED FROM HCSO DEPUTY DEMER				

OWNERS OF PROPERTY

ITEMS NO.	NAME	DOB	ADDRESS	PHONE	NOTIFIED

LAB WORK REQUIRED

ITEMS NO.	PURPOSE OF EXAM

PIN 1302	REPORT DATE 6-12-07	SUPERVISOR REVIEW	PIN	REPORT DATE
----------	---------------------	-------------------	-----	-------------



CAS LE COPY

SEARCH WARRANT INVENTORY

DATE ITEMS REMOVED 6-4-07 CASE NUMBER 20070-31607

DEPUTY SHERIFF SEIZING ITEMS M. KARPATICH 0583 SEARCH WARRANT NUMBER N/A

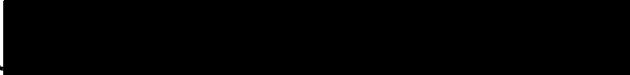
ITEMS REMOVED FROM ADDRESS/LOCATION MASTERS FLATS GPS 

#1  KITCHEN TABLE
FOR  (2006 + NO BELLS)

#2 EVIDENCE FOR  KITCHEN TABLE

#3 PAPER BOWL CONT. TOP SHLE OF BEDROOM
MISC. AMMO. CLOSET

#4 EVIDENCE FOR  TOP SHLE OF BEDROOM
(2005) CLOSET

6-4-07 1910 HRS M. Karpatic 0583
DATE TIME SIGNATURE OF DEPUTY SHERIFF PIN #

DISTRIBUTION: ORIGINAL - LEAVE AT SCENE OF SEARCH WARRANT SERVICE YELLOW - RETURN TO COURT WITH ORIGINAL SEARCH WARRANT



Humboldt County Sheriff's Office
Criminal Investigation Division
Supplemental Report

CASE: 2007-3162

INVESTIGATOR: Sergeant Wayne Hanson

DATE: 06-04-2007

CRIME: Officer Involved Shooting

[REDACTED] State of California

[REDACTED] [REDACTED] [REDACTED]

LOCATION: Bloody Camp Road/ Hostler Ranch, Hoopa

Witness: Sergeant Mike Fridley
Humboldt County Sheriff's Office
Address: 826 4th Street, Eureka
Telephone 530-625-4231

Witness: [REDACTED]
[REDACTED]
[REDACTED]

Witness: [REDACTED]
[REDACTED]
[REDACTED]

Witness: [REDACTED] [REDACTED]
[REDACTED]
[REDACTED]

Witness: [REDACTED] [REDACTED]
[REDACTED]
[REDACTED]

Witness: [REDACTED]

Witness: [REDACTED]

Witness: [REDACTED]

Witness: [REDACTED]

On Sunday, 06-03-2007 in the early evening hours, Lt. Cavinta contacted me by telephone at my residence. Lt. Cavinta advised me that there had been an officer involved shooting at residence located off Bloody Camp Road, Hoopa. Lt. Cavinta told me that the [REDACTED] had shot at several of our deputies. Lt. Cavinta advised me that several of our deputies had shot back at [REDACTED]. Lt. Cavinta told me that [REDACTED] was now barricaded inside of a residence. Lt. Cavinta told me that our Special Enforcement Team was on scene along with other officers from other agencies.

Lt. Cavinta said that Detective Schlesiger was on scene with him as the lead detective in this incident. Lt. Cavinta was requesting that I contact a second detective to respond to his location to assist Detective Schlesiger with the investigation. Lt. Cavinta requested that I respond in the morning with another detective to assist in the investigation. I then contacted Detective Steve Quenell at his residence and requested that he respond tonight to assist Detective Schlesiger at the scene.

I then contacted Detective Marvin Kirkpatrick at his residence and advised him to meet me at our office in Eureka at 0700 hours on Monday, to respond with me to Hoopa. On 06-04-2007 at approximately 0700 hours, Detective Kirkpatrick and I met at our office in Eureka. We then both responded to the Hoopa area in the same vehicle. When I arrived in the Willow Creek area, I spoke to Detective Schlesiger on his cellular telephone. Detective Schlesiger requested that we respond to the Sheriff's Office, Hoopa Station and contact [REDACTED] who is [REDACTED] mother. Detective Schlesiger told me that

██████████ knew where her son, ██████████ was currently staying. Detective Schlesiger requested that I contact ██████████ for a statement, regarding his brother ██████████ ██████████

At approximately 0900 hours, ██████████ arrived at our Hoopa office in her vehicle. Detective Kirkpatrick and I then followed ██████████ in her vehicle to a residence located off Matsen Flat, Hoopa.

Detective Kirkpatrick and I then contacted ██████████ inside of a residence. We then spoke to ██████████ in the kitchen area of the residence at 0910 hours. I recorded our conversation with ██████████ on a digital recorder. I later transferred our interview to a CD-R, which I later booked into evidence. The following is a summary of what ██████████ relayed to us about his brother, ██████████

██████████ told us that ██████████ was up on Bald Hill, freaked out and scared. I asked ██████████ when was the last time he saw his brother ██████████ ██████████ told me that he saw ██████████ Saturday night at his house and he spent the night. ██████████ said that ██████████ was acting a little crazy. ██████████ told us that ██████████ was ██████████ and was a little confused. I asked ██████████ what he meant by a little crazy. ██████████ said that he was walking back and forth in his house. ██████████ said that ██████████ cut up his wet suit with a kitchen knife. ██████████ said that ██████████ put on his wristwatch and put a lot of his clothes on.

██████████ said that ██████████ was not acting normal when he came over Saturday night to his residence. I asked ██████████ if he had seen his brother, ██████████ act like this before. ██████████ said, yes but not this bad. I asked ██████████ if his brother was saying anything to him. ██████████ said ██████████ would not talk to him. ██████████ said that he had to yell, ██████████ do you hear me. ██████████ said that ██████████ would mostly look down at the ground and would not answer him. ██████████ said that ██████████ did tell him that I am your brother the cat.

I asked ██████████ prior to Saturday night when was the last time he had spoken to ██████████ when he was normal. ██████████ said that he saw ██████████ 4 or 5 days before Saturday night and he was not as bad. ██████████ told me that his brother, ██████████ is never completely normal.

I asked ██████████ if ██████████ was drinking alcohol when he saw him Saturday night or Sunday morning. ██████████ told me he did not see him drinking alcohol, Saturday or Sunday. I asked him if he was smoking marijuana or taking other drugs. ██████████ told me he did not know.

I asked ██████████ how he knew that ██████████ ██████████. ██████████ told me that ██████████ told him that he ██████████ a couple of months ago.

██████████ told me that on Sunday morning at approximately 1030 to 1100 hours he gave ██████████ a ride to his Mother's house and his mother called ██████████, because ██████████ was not himself. ██████████ said that ██████████ told him that he did not want to go back to ██████████ ██████████ said that ██████████ was getting angry about going to ██████████

██████████ said that ██████████ acted like he was going to spit on his mother. ██████████ said that he grabbed ██████████ and threw him into his truck.

██████████ said that he then gave ██████████ a ride over to ██████████ house located off Highway 96 in the middle of Shoemaker Road. I asked ██████████ why ██████████ wanted to go to ██████████ house and he told me to get his guitar and amp. ██████████ said he then drove ██████████ over to ██████████ house and left him there. I asked ██████████ if ██████████ had access to any guns. ██████████ told me that ██████████ did not have any guns that he is aware of.

I asked ██████████ if ██████████ has ever threatened to hurt himself or someone else in the past. ██████████ told me that the first time that ██████████ went to ██████████ he was going ██████████. I asked ██████████ if he was present when ██████████ threatened ██████████. ██████████ told me ██████████ had a loaded 12-gauge shotgun in his hands and place the barrel of the shotgun ██████████ at his Mother's house a couple of years ago. ██████████ said that he grabbed the shotgun out of ██████████ hands. I asked ██████████ if the shotgun was loaded and he told me, yes. I asked ██████████ why ██████████ wanted to ██████████ with the shotgun. ██████████ said he did not know why he wanted to hurt himself.

I asked ██████████ how ██████████ got the shotgun. ██████████ said that there father gave it to ██████████ as a Christmas gift when he was 12 years old. I asked ██████████ where the shotgun was now at and he told me that the police took it when this happened.

I then ended my interview with ██████████

I then responded to ██████████ residence after I left ██████████ residence, but ██████████ was not at home. I did locate ██████████ at his residence on Monday, 06-11-2007 for a statement.

Detective Kirkpatrick and I were able to contacted ██████████ on 06-11-2007 at 1015 hours at his residence. I used a digital recorder to record our conversation. I later transferred that interview to a CD-R, which I booked into evidence. The following is a brief summary of what ██████████ relayed to me about this investigation.

I asked ██████████ if he saw ██████████ a week ago Sunday at his residence. ██████████ told me that ██████████ was not taking his medication and was acting bazaar when he saw him on Sunday at 1200 hours at his house. I asked ██████████ how ██████████ came to his house on Sunday. ██████████ told me he walked there. I asked ██████████ how he new that ██████████ was ██████████. ██████████ said he has know ██████████ all of his life and he knows when he is ██████████. I asked ██████████ what ██████████ was wearing on Sunday and he told me a trench coat. ██████████ told me he asked ██████████ to leave, because he was being loud around his kids. ██████████ said when ██████████ left he walked away from his residence.

I then ended my conversation with ██████████ ██████████

Detective Kirkpatrick and I then responded to the Incident Command Post located off Bloody Camp Road, Hoopa. I contacted Lt. Cavinta and Detective Schlesiger. I was

briefed by Lt. Cavinta of the situation. Lt. Cavinta advised me that [REDACTED] was still inside of a residence and Sgt. Mike Fridley was attempting to contact [REDACTED] via a patrol vehicle's external broadcast system. Lt. Cavinta advised me that the Sheriff's Office Special Enforcement Team, Eureka Police Department's tactical team and the California Department of Corrections tactical team were on scene with a perimeter set up around the residence.

Detective Schlesiger requested that I attempt to contact any neighbors in the area that may witnessed any of the situation involving this incident with [REDACTED]. Detective Schlesiger also requested that I attempt to locate two [REDACTED] with the last name of [REDACTED] that might have seen [REDACTED] on Sunday. Detective Schlesiger said that the [REDACTED] may live a mile or so further up Bloody Camp Road. I then stayed on scene at the Command Post for the rest of the time.

At approximately 1840 hours, Deputy [REDACTED] and I began to check with the neighbors in the area to see what they may have witnessed regarding this incident.

I drove down to a dirt road, which is located just south below [REDACTED] property. I contacted the occupants of that residence, who I identified as [REDACTED] and his wife [REDACTED]. They told me that their address is [REDACTED] Road, Hoopa, because they do not want to use the name [REDACTED] as their address. I used a digital recorder to record our conversations. I later transferred my interview to a CD-R, which I booked into evidence. The following is a brief summary of what they relayed to me about this investigation.

Both [REDACTED] and [REDACTED] told me that both left to go out of town on Friday, June first at 1930 hours and returned home on Monday, June 4th at 0130 hours. Both [REDACTED] and [REDACTED] told me that they had no idea on what may have transpired at [REDACTED] residence, which is located to the north above their residence. I then ended my conversation with the [REDACTED]

I then returned the scene at 2000 hours and secured the residence and property with Sergeant Buhiner and Deputy [REDACTED] until Detective Marvin Kirkpatrick, EPD Detective Kevin Lawson, ID Tech [REDACTED] and Arson Task Force members arrived in the morning on Tuesday, 06-05-2007 to start their investigation.

On 06-05-2007 at 0830 hours, I went to another neighbor's residence, which is located just to the west of the [REDACTED] residence. I contacted [REDACTED] at the residence, who told me that he lived here with his wife, [REDACTED] and their 5-year-old daughter. [REDACTED] told me that his wife and daughter were not currently home. I used a digital recorder to record our conversations. I later transferred my interview to a CD-R, which I booked into evidence. The following is a brief summary of what [REDACTED] relayed to me about this incident.

[REDACTED] told me that on Sunday, he received telephone calls from friends, who were listening to police scanners. [REDACTED] told me that those friends told him that the police were

at his neighbor's [REDACTED] house. [REDACTED] told me that in the evening hours on Sunday, Hoopa Tribal Police and a Deputy Sheriff came to his residence to evacuate him, because shots were fired at [REDACTED] property. [REDACTED] said police officers came to his house at about 2100 hours. [REDACTED] said he told those officers to be careful, because he has heard automatic gunfire coming from [REDACTED] property in the past. [REDACTED] said those officers told him that they had [REDACTED] inside of [REDACTED] house.

I asked [REDACTED] if he heard shots being fired at [REDACTED] property on Sunday. [REDACTED] told me that he hears gunshots all the time at the [REDACTED] property. [REDACTED] did tell me on Sunday, he heard 4 or 5 gunshots coming from the [REDACTED] property in the afternoon. [REDACTED] said he was unsure on what time he heard the gunshots on Sunday. [REDACTED] said that the gunshots came one after the other in rapid fire. [REDACTED] said after he heard the gunshots he told his wife to take their daughter and leave for their safety. [REDACTED] said that he was outside working on his truck when he heard the gunshots.

I asked [REDACTED] if he saw police vehicles coming to [REDACTED] property. [REDACTED] said that he saw, Sheriff and Hoopa Tribal Police going to [REDACTED] property with their emergency lights on. I asked [REDACTED] if he knows [REDACTED] and he told me, no.

I asked [REDACTED] if he heard anyone yelling from the [REDACTED] property when law enforcement was on scene. [REDACTED] said he heard someone, "hooping and hollowing". [REDACTED] went on to tell me through out the day when law enforcement was on scene he heard three separate volleys of gunshots. [REDACTED] told me at approximately 2000 hours he heard approximately 4 to 6 gunshots. [REDACTED] said he was outside of his residence and he heard officers state, we returned fire. [REDACTED] said he heard officers calling for a roll call after he heard the gunshots. [REDACTED] said he could hear an officer on the police loud speaker, telling the subject to come outside. [REDACTED] said he could not remember the exact words that the officer on the loud speaker was saying.

I asked [REDACTED] if he was able to see what officers at [REDACTED] house were during this incident. [REDACTED] told me had he walked to the rear of his property he could see [REDACTED] house, but because of the gunshots being fired that would not be safe. [REDACTED] told me he eventually left his property Sunday night at about 2100 hours .

[REDACTED] told me that on Monday morning about 0900 hours he returned home. [REDACTED] said he remembers on Monday morning hearing some type of shooting occurring on [REDACTED] property. [REDACTED] described those sounds as more of thuds not gunshots. (I believe [REDACTED] was hearing chemical agents being fired from a 37mm into [REDACTED] residence).

[REDACTED] told me that on Monday he was at his house when he saw smoke coming from [REDACTED] property. [REDACTED] said he saw fire trucks on the road and heard fire personnel state, wait until it's safe, before you go in. [REDACTED] said he was unsure on what time this occurred. [REDACTED] told me that his wife, [REDACTED] was not currently at home, but he would call me on my cellular telephone when she returns home this morning. I then left his residence. A short time later I received a telephone call from [REDACTED] [REDACTED] who told me she was now at home.

I then ended my interview with [REDACTED] [REDACTED]

On 06-05-2007 at 0955 hours, I spoke to [REDACTED] [REDACTED] at her residence, regarding this investigation. I used a digital recorder to record our conversation. I later transferred the interview to a CD-R, which I booked into evidence. The following is a brief summary of what Carmeli relayed to me about this investigation.

[REDACTED] told me on Sunday, she was aware of a problem occurring at [REDACTED] [REDACTED] property, because she received several telephone calls from friends, who were listening to police scanners. [REDACTED] told me that those friends told her that there might be some sort of hostage situation occurring at [REDACTED] [REDACTED] house.

[REDACTED] told me when she looked outside she saw cops above her house at approximately 1530 hours on the driveway leading to [REDACTED] [REDACTED] house. [REDACTED] told me at 1830 hours she heard gunshots coming from the [REDACTED] property. [REDACTED] said after she heard the shots she looked up the hill from her house and saw one or two cops ducking. [REDACTED] said she does not remember how many shots she heard, but it was more than one. [REDACTED] said after the shots were fired her husband, [REDACTED] told her and the kids to leave and go down the hill. I asked [REDACTED] if she knew [REDACTED] and she told me, no.

I then ended my interview with [REDACTED] [REDACTED]

On 06-05-2007 at 0900 hours, I contacted [REDACTED] and her daughter, [REDACTED] [REDACTED] at their residence located at [REDACTED] Bloody Camp Road, Hoopa. The [REDACTED] residence is located approximately [REDACTED] miles up Bloody Camp Road from [REDACTED] [REDACTED] property. I used a digital recorder to record our conversations. I later transferred the interview to a CD-R, which I booked into evidence. The following is a brief summary of our conversations.

I asked both [REDACTED] and [REDACTED] if they knew [REDACTED] and when was the last time they saw or spoke to him. They both told me that they saw [REDACTED] on Sunday at 1300 hours, when they both drove down Bloody Camp Road in their vehicle to go to the store.

[REDACTED] and [REDACTED] when they returned from the store they saw, [REDACTED] walking up Bloody Camp Road. They told me that [REDACTED] was approximately half way up the hill near the deerskin gate off Bloody Camp Road. They both said that they recognized [REDACTED] and stopped to see if he needed a ride. They both told me that they have known [REDACTED] for years.

I asked them what [REDACTED] was wearing and they both told me a trench coat and a beanie hat. They both told me it was approximately 80 degrees on Sunday and [REDACTED] was sweating. I asked what [REDACTED] said when he got into their vehicle. [REDACTED] told me that [REDACTED] told them he was going to [REDACTED] and [REDACTED] house to visit. I asked them if [REDACTED] was carrying anything and they told me a thermos. I asked them if [REDACTED] was acting different than he normally does on Sunday. They both told me that he had a weird look in

his eyes. I asked them what they meant by a weird look in his eyes. They told me that he looked like he had something on his mind and did not talk too much. They said [REDACTED] said he needed some sleep and water to drink.

I asked [REDACTED] and [REDACTED] if they gave [REDACTED] a ride in their vehicle. They told me that they gave [REDACTED] a ride and dropped in off in front of [REDACTED] and [REDACTED] driveway. I asked [REDACTED] and [REDACTED] if it was normal to see [REDACTED] on Bloody Camp Road. They both told me that they have never seen [REDACTED] walking on Bloody Camp Road in the past.

I then ended my interview with [REDACTED]

On 06-05-2007 as I was leaving the Bald Hill area, I spoke to DA Investigator, Mike Hislop on the radio. Hislop requested that I contact Sergeant Mike Fridley for a statement of his involved in this incident and take custody of some cassette tapes that Sergeant Fridley used to record his conversation, when he was negotiating with [REDACTED] I then responded to the Sheriff Office substation located in Hoopa at 1325 hours to speak with Sergeant Fridley.

I spoke Sergeant Mike Fridley and I recorded our conversation on a digital recorder. I later transferred my interview to a CD-R, which I booked into evidence. The following is a brief summary of what Sergeant Fridley relayed to me about this incident. Sergeant Fridley had already given a statement to Detective Quenell about this incident on Sunday night.

Sergeant Fridley told me that he is a hostage negotiator for the Humboldt County Sheriff's Office. Sergeant Fridley told me that he responded to [REDACTED] [REDACTED] property located off Bloody Camp Road, Hoopa on Sunday, 06-03-2007. Sgt Fridley told me that when he arrived on scene he used a Hoopa Tribal Police vehicle as cover. Sgt. Fridley said that Deputy Jason Daniels was also with him, because Deputy Daniels is also a hostage negotiator for the Humboldt County Sheriff's Office. Sergeant Fridley told me while on scene setting up negotiations with [REDACTED] he was positioned approximately 50 yards to the south east of the residence.

Sergeant Fridley told me that when he began to negotiate with [REDACTED] he used the loud speaker on the Hoopa Tribal Police vehicle. Sergeant Stewart said that when he was speaking on the loud speaker he would turn on his cassette tape recorder to record his negotiation with [REDACTED] Sergeant Fridley said that he used a total of 6 cassette tapes during the course of his negotiation with [REDACTED] Sergeant Fridley said he booked those 6 cassette tapes into evidence at the Hoopa sub station. I asked Sergeant Fridley to give me those 6 cassette tapes, which he then provided to me. I later transported those 6 cassette tapes and placed them into our evidence locker in our main office in Eureka.

Sergeant Fridley said when he and Deputy Daniel were on scene they were kneeling down behind the driver's side of the Hoopa Tribal police vehicle using the engine block as cover. Sergeant Fridley said that there were two Hoopa Tribal police vehicles on scene

and Sheriff's Office Special Enforcement Team (S.E.T.) members were using the other vehicle as cover. Sergeant Fridley told me at approximately 2053 hours he heard someone yell that the [REDACTED] was opening one of the windows on the house. Sergeant Fridley said he then turned on his cassette recorder and he started talking to [REDACTED]. Sergeant Fridley said that he was using the loud speaker on the patrol vehicle.

Sergeant Fridley said when he started talking on the loud speaker he heard the sound of a bullet strike near his location. Sergeant Fridley said he heard the crack and snap of the bullet. Sergeant Fridley said the bullet went through the brush approximately 5 feet from his location. Sergeant Fridley said that he captured the sound of the bullet on his tape recorder. Sergeant Fridley said that recording was on cassette number one side B.

Sergeant Fridley said after he heard the shot he broadcasted on the radio, shots fired. Sergeant Fridley said S.E.T. members on scene returned fire. I listened to the cassette tape that Sergeant Fridley described to me. I could clearly hear the first shot that Sergeant Fridley described to me as the crack and snap of a bullet. I then heard on the tape cassette a second later 6 shots one after the other.

I then spoke to Sergeant Fridley on what had transpired on Monday, 06-04-2007. Sergeant Fridley said that after Sunday night he went home to get some sleep. Sergeant Fridley said he came back to work on Monday, 06-04-07 at 0800 hours. Sergeant Fridley said that he drove back to the location of this incident. Sergeant Fridley said he was on scene again to be the negotiator attempting to convince [REDACTED] to come out of his residence peacefully.

Sergeant Fridley said on Monday morning and he was unsure of the time, S.E.T members started to use chemical agents in an attempt to get [REDACTED] out of the residence. Sergeant Fridley said, because S.E.T members were wearing protective chemical masks they were unable to use the loud speaker to tell [REDACTED] to come out of his residence peacefully. Sergeant Fridley said that he was then broadcasting on the loud speaker from the Hoopa Tribal police vehicle to tell [REDACTED] to come outside and surrender peacefully to law enforcement. Sergeant Fridley said he made the announcement on the loud speaker every 10 to 15 minutes for several hours telling [REDACTED] to please surrender, before chemical agents were placed into the residence.

I asked Sergeant Fridley if he witnessed chemical agents being deployed into the residence. Sergeant Fridley said he witnessed two different types of chemical agents that were deployed into the residence. Sergeant Fridley said the first type was a ferret round that was shot from a short looking type shotgun. Sergeant Fridley said that they were being shot at side 4 of the residence, windows A and B, which was the south side. Sergeant Fridley said that ferret rounds were also fired at the south side by a 12-gauge shotgun.

I asked Sergeant Fridley which officers were firing the ferret rounds. Sergeant Fridley told me he witnessed Deputies Brian Taylor, Jamie Barney firing the ferret rounds. I asked Sergeant Fridley if he heard any movement from inside of the residence or any

yelling from inside of the residence during the time frame that the ferret rounds were being deployed. Sergeant Fridley told me that he did not hear any movement, nor did he hear any yelling coming from the residence.

I asked Sergeant Fridley if he witnessed deputies at some point approach the residence with a ballistic blanket on the south side of the residence. Sergeant Fridley told me that he saw Sergeant Brain Quenell, Deputies Brian Taylor, Jesse Taylor, Massaro, and Barney. Sergeant Fridley said because of the distance he could not tell, who threw hand held chemical agents into the residence. Sergeant Fridley told me that on the south side, which is also know as side 4. He saw what he believed was two hand held chemical agents thrown into windows A and B on side 4. Sergeant Fridley said after the hand held chemical agents were thrown inside, he saw white smoke coming out of the windows.

Sergeant Fridley said after the hand held chemical agents were thrown into the windows the S.E.T. members retreated from the residence using the ballistic blanket as cover. Sergeant Fridley said that after a while the white smoke stopped. Sergeant Fridley said 5 to 10 minutes after the white smoke stopped he saw black smoke coming from window B on side 4 of the residence, which is the south side.

Sergeant Fridley said that when he started seeing the black smoke coming from inside of the residence he started advising [REDACTED] over the loud speaker numerous times to come outside, because the house was on fire. Sergeant Fridley said he eventually saw flames inside of the residence. Sergeant Fridley said he could hear popping sounds, what he believed were rounds going off inside of the residence from the fire.

Sergeant Fridley said after approximately 45 minutes the Fire Department approached the residence with CDC SWAT team as protection.

I then ended my interview with Sergeant Fridley.

 0330

7/9/07
Sergeant Wayne Hanson

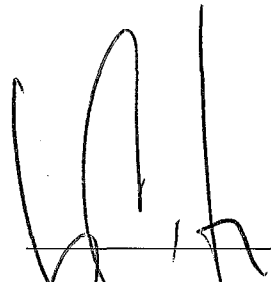
Supervisor 7/9/07

**HUMBOLDT COUNTY SHERIFF'S OFFICE
PROPERTY/EVIDENCE BOOKING AND RELEASE REPORT**

CASE NUMBER: 2007-316Z

PAGE _____ OF _____

DATE STORED <u>6/21/07</u>	TIME STORED <u>1300</u>	DATE OF INCIDENT <u>6-4-07</u>	CRIME <u>664/187 P.C.</u>
NAME OF FINDER (ADDITIONAL VICTIM) <u>STATE OF CAL.F</u>		DOB	ADDRESS
NAME OF FINDER (ADDITIONAL VICTIM)		DOB	ADDRESS
LOCATION PROPERTY WAS FOUND (INCIDENT OCCURRED)			

ADULT ARREST
 JUVENILE ARREST
 SEARCH WARRANT NO. _____

TYPE OF PROPERTY

EVIDENCE
 FOUND
 SAFEKEEPING

PROPERTY CODES *178

S - Stolen	D - Damaged
R - Recovered	L - Lost
RA - Recovered (For Other Agency)	E - Evidence
F - Found	K - Safekeeping
	C - Contraband

[REDACTED]	DOB
[REDACTED]	DOB

PROPERTY/EVIDENCE LISTING

CODE	ITEM NO.	QTY.	DESCRIPTION	VALUE	NCIC	WEIGHT	DISPOSITION
E	101	60	CD-R's OF STATEMENTS FROM: SGT MIKE FRIDUSY				
[REDACTED]							

[REDACTED] OF PROPERTY

ITEMS NO.	NAME	DOB	ADDRESS	PHONE	NOTIFIED
ITEMS NO.	NAME	DOB	ADDRESS	PHONE	NOTIFIED
ITEMS NO.	NAME	DOB	ADDRESS	PHONE	NOTIFIED

LAB WORK REQUIRED

ITEMS NO.	PURPOSE OF EXAM
ITEMS NO.	PURPOSE OF EXAM
ITEMS NO.	PURPOSE OF EXAM

BOOKING OFFICER <u>W. Hanson</u>	PIN <u>0330</u>	REPORT DATE	SUPERVISOR REVIEW	PIN	REPORT DATE
-------------------------------------	--------------------	-------------	-------------------	-----	-------------

CASE FILE COPY

HUMBOLDT COUNTY SHERIFF'S DEPARTMENT

CASE: 200703162
INTERVIEWER: Sergeant Wayne Hanson
SUBJECT: Attempt P.C. 187/ Officer Involved shooting.
STATEMENT OF: [REDACTED]
DATE & TIME: June 4th, 2007 9:10 A.M.
LOCATION: Hoopa, California
ALSO PRESENT: Marvin Kirkpatrick, Detective

WH Wayne Hanson
MK Marvin Kirkpatrick
[REDACTED]
UF Unknown Female

WH Uh the time is ten after nine (9:10) in the morning, on Monday June the forth (4th), two thousand seven, (2007), I'm in Hoopa with uh Detective Marvin Kirkpatrick, Sergeant Wayne Hanson, I'm talking to [REDACTED], [REDACTED], [REDACTED] about his brother. Um you know what's going on, why we're here?

[REDACTED] A little bit.

WH Okay and you're [REDACTED] brother, younger brother older brother?

[REDACTED] Younger brother.

WH Younger brother. What's been going on um with your brother [REDACTED] and why do you think we're here this morning?

[REDACTED] Um he's up there freaked out scared

WH Up, up, up where?

[REDACTED] On Bald Hill there.

WH Okay. Um when's the last time you spoke to your brother?

■ Um yesterday, he stayed the night at my house the night before.

WH Stayed here?

■ At my house over there.

WH Oh where's your house at?

■ (Inaudible)

WH Oh this here, and whose house is this then?

■ Mine.

WH Okay so he stayed here?

■ This house here?

WH Yeah.

■ This is my great aunts house,

WH Oh great aunt.

■ She's in the living room.

WH Oh okay.

■ This is just,

WH What's the address here, you don't know the add, this, the address you gave me this morning is where you're, you're house,

■ Where I live.

WH And this is your great aunts house?

■ Yeah.

WH What's your great aunts name?

■ [REDACTED]

WH Spell the first name?

█ [REDACTED]

WH Okay. So you saw your brother [REDACTED] yesterday now?

█ Yeah I dropped him off.

WH And where did you drop him off at?

█ I went over my mom's house first and he was just talking kind of crazy a little bit and just, just

WH Well what,

█ Confused like he don't he's [REDACTED] and he don't.

WH Where did you originally see him at yesterday before you dropped him off?

█ He was at my house.

WH At your house, what time was that?

█ Stayed the whole night the night before.

WH Oh okay so you, this is,

█ My girlfriend was going to work so I was gonna,

WH So this is Monday so it was Sunday, yesterday is when you saw your brother, so he came over Saturday night?

█ Yeah.

WH What time Saturday night?

█ Well I came over here, up at his house with my mother and uh,

WH That's the trailer right above us there?

█ Yeah to come see him cause he was in jail or whatever,

WH Okay.

■ And he was up staying at my house.

WH So Saturday night he was being kind of crazy you said?

■ Well he, not crazy he's just walking back and forth in my house, kind of just like he cut up my wet suit you know and I think he put half of it on, I don't, I don't know.

WH How did he cut your wet suit up, with what?

■ I don't know probably kitchen knife or something in there.

WH Did you see him cut your wetsuit up?

■ No.

WH Okay. You just found it cut up?

■ Yeah in the morning I woke up you know he had my watch on and he had all kinds of clothes on just uh not acting, you know.

WH Not your normal brother?

■ No.

WH Has he acted like that before, you see him like that before?

■ Yeah, not, not quite as, as bad.

WH Was he making any bizarre statements or just?

■ He wasn't saying much I mean if he, if I asked him a question he, he would just kind of looked at me and looked back down and did you hear me, can you answer me, yeah I can, but then not answer me you know.

WH And that's not normal behavior,

■ No.

WH For your brother?

■ Well he's been like this in the past before three (3) or four (4) times but you know but then he goes on and off his,

WH Before,

■ The way he is.

WH Before Saturday night when's the last time you spoke to your brother when he was normal?

■ I don't know four (4) or five (5) days before that?

WH And he was completely normal?

■ No he's never completely normal, he's just, I mean he was, he could ask me questions and you know do normal things but he's I don't know.

WH Was he drinking or at all?

■ No.

WH Was he taking, [REDACTED]?

■ I don't know.

WH Okay. So on Saturday night he's at your house and um again was he, was he making any kind of weird statements, bizarre statements that you can recall?

■ Um yeah he was just saying like I'm his brother the cat or something just stuff like that. My girlfriend is, is um his blood sister now and all kinds of just things that I could kind of pick out some things that made sense but, you know the whole shot it wasn't, it just didn't make any sense.

WH Okay then everybody, you go to sleep, who's home with you when your brother's over there, anybody else with you?

■ Me and my girlfriend.

WH Who's your girlfriend?

■ [REDACTED]

WH Where's she at?

■ She's down at the [REDACTED] right now at work.

WH Down where

■ The [REDACTED]

WH Oh okay,

■ She works there, she's at work right now.

WH So you go to sleep in the morning, um you wake, that would have been Sunday morning?

■ Um yeah.

WH Cause today's Monday.

■ Yeah, yeah.

WH And then you give your brother a ride somewhere and where was that to?

■ Went over my mom's first and then um he was just still kind of being the same way, so she got on the phone and call uh [REDACTED] and um he went and sat back in the truck and said he didn't want to go there anymore, and he was kind of hollering a little bit, telling me to hurry up and then he would get back out as soon as I got in would just stand there for a minute, I don't know.

WH Was he being angry or?

■ Little bit more, I mean he wasn't angry at all but and then he got over there and he I don't know he, he sees my mom and I don't know just gets a little angry.

WH I mean was he threatening to, to hurt you or hurt anybody else or threatening to hurt himself or anything like that?

■ Well no he, he, he acted like he was going to spit on my mom and it pissed me off and I grabbed him by his shoulder and just shoved him in the truck and said we got to go.

WH Why does, why did he want to spit on your mom for?

■ He gets things in his head, I don't know what's going on.

WH Okay and then you put him in the truck and about what time of the day was that, do you remember?

■ Um shoot, eleven (11).

WH In the morning?

■ Ten thirty (10:30) eleven (11) maybe.

WH Okay and you gave him a ride to where?

■ ■■■■■ house.

WH And where's that at?

■ That's up um in between Highway Ninety Six (96) and Shoemaker road, right in the middle, it's um down by uh,

WH Why did he want to go to ■■■■■ house for?

■ To go get his guitar and his amp or something.

WH Okay. And then once you take him to ■■■■■ house, do you leave him there or do you take him someplace else after that?

■ He went in for a minute and, and uh ■■■■■ woman came out and uh he said he was gonna go see if they were awake or whatever.

WH Pardon me.

■ He was gonna go see if they were awake or whatever.

WH Okay.

■ And then he came out and said alright bro, I'll see you later.

WH Okay. You waited in the truck and he went in by himself?

■ Just yeah for a knock on the door and then,

WH Uh huh.

■ You know they opened the door and he was like all right.

WH Did he pick up the guitar or anything?

■ I don't know.

WH Did he get back in your truck with something, the guitar you'd be able to tell it's a pretty big item.

█ No he didn't get back in the truck, he stayed there.

WH Oh he stayed there and you, you took off?

█ Yeah.

WH And you took off?

█ Yeah.

WH And that's the last time you saw him?

█ Yeah. He said I'm gonna stay here with my friends you know.

WH Okay. █ █ house is exact; I'm not that familiar with Hoopa.

█ Um draw you something.

WH Pardon me?

█ Draw you something maybe, I don't,

WH Do you have a phone number?

█ No I don't, it's one (1) of his friends I guess I don't really know the guy.

MK What's the girlfriend's name you said that █ █ girlfriend?

█ Her name's █ I believe.

WH █

MK █

WH Um so with your brother um again would be kind of redundant, so it wasn't your normal brother seemed a little off on Saturday night and Sunday?

█ A little off compared to even being off normally yeah.

WH Yeah. And a little like he wanted to spit on your mom a little agitated kind of, hostile or?

■ No just I don't know what he wanted he just,

WH I mean it's not normal behavior

■ I don't know what he wanted he just.

WH It's not normal behavior to spit on, act like he's going spit on your mom is it?

■ Uh huh. I don't know what he,

WH Does your brother have any guns that your aware of?

■ No he don't. He had this,

WH I mean do you have any guns at your house that you're missing or anything like that?

■ No.

WH When you, when you left him off at um ■■■■■■■■■■ house, your brother wasn't, do you remember what he was wearing, he doesn't have a backpack or anything like that?

■ NO.

WH Okay.

MK Do you remember what he was wearing?

■ That cut up wet suit I think um,

MK What do you mean by a wet suit, what, what part of the wet suit are you talking about, is this like a diving wet suit?

■ Yeah.

MK Okay.

■ Cut off right here, had the long arms, he cut the arms off and,

WH What, what logical reason do you think your brother cut up your wetsuit to put it on?

■ I don't know.

WH This is bizarre,

■ Yeah.

MK So he cut the legs off to make them like shorts?

■ Well they're already like that.

MK Is it a one (1) piece?

■ Yeah.

WH Are you about the same size as your brother?

■ No I'm inch and a half taller maybe

WH Oh so,

■ Fifteen (15) twenty (20) pounds heavier maybe, fifteen (15) pounds heavier.

WH Does it kind of make you mad that he cut you your wet suit?

■ Nay, yeah a little bit yeah (inaudible) pissing me off.

WH Do, does your brother ever get combative with you, you guys ever fight?

■ When we were little I guess.

WH So what, what do you think is causing his bizarre behavior?

■ Scared right now.

WH I mean on Saturday night and Sunday what was causing that strange behavior.

■ I don't know, [REDACTED].

WH You know what types of [REDACTED] he takes?

■ [REDACTED] once a month [REDACTED] a couple other things, vitamins something and vitamin c maybe I don't know.

WH Has your brother always been a little off for years or just happening recently?

■ I don't know five (5) or six (6) years maybe.

WH That he takes medication to keep him, try to keep him normal?

█ Yeah. When he's taking his medication he's fine I mean he's,

MK Where does he seek medical attention at?

█ Over at K'ima Medical Center.

MK They're the one's treating him, █?

█ I believe yeah.

MK Did, does he go anywhere else that you know of?

█ █, they probably gave him whatever.

MK To see the doctor or actually been in the facility?

█ Been in there a couple times, a little bit.

MK Okay.

WH How did he get to █ last time, who took him?

█ Um

WH That was about a week ago or so?

█ Oh that time?

WH Yeah.

█ The ambulance.

WH I mean who, who called?

█ My mother probably or I don't know who, yeah my mother I think.

WH Was that like a week or two (2) ago or do you remember?

█ Um Wednesday, last Wednesday maybe.

WH This is Monday, so Wednesday of last week?

█ I think so.

WH And what was he doing Wednesday of last week that prompted your mom to call, do you remember?

■ Um just I don't know, I don't know what went on over there.

WH Oh you weren't there when the ambulance showed up at your mom,

■ Nay she lives on the other side of town.

WH Oh your mom just relayed to you what, why he had to go?

■ I didn't even know until yesterday when I came over here with her that he went out town and did all that and went to jail and stuff.

WH He went to jail last week also?

■ He went to um,

WH Or [REDACTED]

■ He went to both.

WH And you can't recall what he did last week what your mom told you?

■ At her house?

WH Yeah.

■ I don't know, or, argument maybe, I don't know.

WH Okay.

■ Probably, I don't know.

WH And your brother normally lives by himself in the trailer right up the road here?

■ Yeah, might stay a night down here, stay a night at my house once or twice a week you know just lives up there you know, yeah he stays up there.

WH By himself?

■ I guess yeah.

WH Does your brother have a girlfriend?

■ I don't know, I don't think so.

WH Okay. Does your brother ever threaten to hurt you or hurt your mom, or hurt anybody else that you're aware of, is that no?

■ No.

WH Okay. Has he ever threat,

■ I mean everyone's gotten in fights before you know with just people that I mean I have before but not just off the wall in particular you know being threatening to anybody your just, no.

WH Has he ever threatened to hurt himself or hurt, hurt some cops or anything like that?

■ Um I think the first time he went to ■ he was, he was um going to ■

WH Is that what somebody relayed to you or did?

■ I was there.

WH And what did he say?

■ He had a twelve (12) gauge in his hand, he was at my mom's house,

WH How long ago was that?

■ Couple years ago.

WH And how was that defused, somebody?

■ I took it from him.

WH Was it loaded?

■ Yeah.

WH And why, why did he want to hurt himself?

■ I don't know.

MK Where did he get that gun?

■ He got it for Christmas from my dad about I don't know when we were twelve (12) years old, thirteen (13).

MK So it was his shotgun?

■ Yeah.

MK Okay.

WH What happened to that shotgun, where is it at now?

■ Police took it.

MK Did he say he wanted ■?

■ Um I believe yeah, he turned around and stuck it in his mouth and I grabbed it from him. It didn't go off or nothing.

MK Uh huh.

WH Did you have to wrestle it from him or he just gave it up when you grabbed it?

■ Just gave it up. Feels lonely I think, cry for help, I mean he don't have that many friends you know, never really had a steady girlfriend you know he lives by himself. I don't know he has ■ and he just, I don't know.

WH And that was a few years ago?

■ Yeah.

WH About how many do you remember?

■ Two (2), two and a half (2 ½).

WH And that was at your mom's house?

■ Yeah.

WH Has there been any other things like that since, with a weapon or any kind of threats that he wanted to hurt himself?

■ No.

WH Until recently when he's acting bizarre again?

■ Well he never made no threats.

WH Okay.

■ The only reason, he's never ever that I recall I mean.

MK Where's your mom's house at?

■ Um house number [REDACTED], down by the

MK You don't know how your brother got to where he's at from the house you dropped him off?

■ No. Someone there probably gave him a ride.

WH See the reason we're here talking to you we're just trying to gather as much information we can about your brother, trying to you know make him, convince him to come out of the house.

■ I can go up there and make him come out,

WH No we can't.

■ If you guys let me do it.

WH We can't do that it's against all policy and procedures to have a family member try that cause sometimes that makes people more angrier.

■ It wouldn't tho.

WH Yeah but can't do that. Um

■ It would be simple and easy.

WH Pardon me.

■ It would be simple and easy.

WH Yeah but we can't do that.

■ I know I understand though.

MK We, we have done that in the past and it's backfired.

WH Yeah so all our training and stuff, we're not allowed to do that. One (1) it would put you in harms way.

MK Yes.

WH And all kinds of stuff, um anything else that we need to know about your brother that we haven't asked you?

■ No.

WH If you were talking to him what would you tell him why to come out, I mean some magical thing you know, the love of his mom, or his grandparents or?

■ I mean in his head it's just like what's going on it's getting stretched out in his mind just goes and goes and goes you know and just congers up his own little what's going on you know, just say hey what the hell you doing, come back to fucking reality I'll tell him, quite being fucking stupid but then you know put my arm around him, tell him I love him or something you know and uh oh yeah okay or something.

MK How do you know he's ■

■ Because he says he hasn't been taking it.

MK Did he say how long he hasn't been taking it?

■ Few months I guess.

MK It's been that long?

■ Yeah.

MK He hasn't got his once a month ■

■ Uh huh.

MK And he takes ■?

■ Yeah he takes five (5) six (6) pills everyday, use to.

WH Where does he store those pills at inside of his trailer or does he keep them here?

■ Um he use to have a backpack full and I use to have like my own over there when he came over you know he'd take them if he didn't have them, you know things like that but I haven't seen that red pack back around in a long time.

MK He told you he stopped taking them, and how long has that been?

■ Couple months?

MK Okay. So you know he hasn't been at least two (2) months, [REDACTED] [REDACTED]?

■ Yeah that's why, yeah I, I don't know really, I mean she must.

MK Do you ever try to convince him to try to take his meds?

■ I mean he'd take them if they were sitting right in front of him there yeah, probably just lost them or something and just forgot about it and just, just went.

WH Anything else that we forgot to ask you to say about your brother?

■ He's not a violent person really I mean he's.

WH Again we're just you know talk to you trying to figure out your brother and try to

■ I mean he's just like me, he just a little, he's just a little bit off kind of, little bit more high strung a little bit you know more uh I don't know he likes to fantasize and stuff I guess I don't know.

WH Fantasize about what?

■ I don't know just, not fantasize but he likes to tell stories a lot but there just complete exaggerations of maybe a part of something he use to you know did or something it would just unravel into like a movie or something I don't know. Right now he thinks you know probably just that.

WH Do you know what's going on right now with your brother?

■ Yeah.

WH What's, did somebody tell you?

■ Yeah I been talking to [REDACTED] a little bit.

WH To who?

WH Oh who's [REDACTED]

[REDACTED] The owner of the house.

WH Oh okay and what did she tell you is going on?

[REDACTED] You guys know what's going on, I don't know she just,

WH I just got up to Hoopa about an hour ago.

[REDACTED] Oh she tells me that uh [REDACTED] came up there and um and um was trying to visit them or something and I don't know he was acting kind of weird or something so she called my mom and um they wanted to have a ambulance and a um cop go up there you know to go get him and take him cause after I left that's what was gonna happen and the cop came and uh he started getting all freaked out and her and her husband and her kid went outside to talk to the cop and the cop told them not to get back in there and um he fired a shot and they fired some shots back I guess and um,

WH Where do you think your brother got the gun at?

[REDACTED] Probably in that house.

Mk Is he related to [REDACTED]

[REDACTED] No. We use to live right down below them about, ten (10) years ago, lived up on the hill for about six (6) years, we're kind of neighbors.

WH Did you keep, I think I already asked you this, did you keep any guns at your house?

[REDACTED] I have one (1) yes.

WH Is it there this morning?

[REDACTED] Yeah.

WH Okay. What kind of gun do you have?

[REDACTED] It's a Rossi twenty two (22) pump.

WH Okay and you're positive the only gun you have is in your house?

■ Yeah.

WH Okay.

■ I got that when I was about twelve (12) too.

UF Oh excuse me.

WH Oh sorry. Um ■, can you draw me a map then?

■ There's an intersection here, Highway Ninety Six (96), there's an intersection right here, and then there's a store right here, it's called D.C.'s or something and then there's a house right here like a lot with a trailer in it and then another one (1) right next to it and then it goes up.

WH What street is this here?

■ I don't know what this one's called, but then it goes up to the top and there's a stop sign right here,

WH Is D.C.'s down by the gas station?

■ It's um on Highway Ninety Six (96) up by,

WH Is it in the north end of the valley?

■ Yeah like it's right past the modular, well if you're going south,

WH Back towards, excuse me south back towards Willow Creek?

■ Willow Creek. It'd be up on the right hand side before you get to the modular plant.

WH Oh D.C.'s is?

■ This is, this is coming from um Willow Creek right here and then it's probably like a half a mile and here's the modular factory right here.

WH Okay.

■ You know and it goes up and there's a intersection right here that goes down and around.

WH And that goes to the river?

■ Yeah it goes down to ■ point there, you can overlook the river and this just keeps on going.

WH Mm hmm towards Hoopa?

■ Yeah. Blue Slide right there and then this one (1) up here, this road goes all the way up you know around and hits the highway right here.

WH Okay.

■ And that one's, that's one's um Shoemaker road.

WH There's a road sign off of ninety six (96) for Shoemaker?

■ Mm hmm yeah.

WH Okay. So where they're place is?

■ And theirs is right here.

WH On the corner there, so once I come off ninety six (96)?

■ Yeah once you take a um, well it'd be a right coming from this way.

WH Right okay.

■ And then you'd see D.C.'s right here.

WH Mm hmm.

■ And then there's a lot right here with like a house in it

WH Mm hmm.

■ And there's a double wide trailer and that's his.

WH What color is it?

■ It's um ■■■■■

WH And they, they have any vehicles?

■ A few vehicles sitting out there.

WH What, what kind of vehicles, color?

■ I'm not sure.

WH So basically the distance from here to here is just a couple hundred yards?

■ A hundred and fifty yards, (150) two hundred (200) hundred.

WH Okay so basically it'd be the D.C.'s and then the, not this place the second place past D.C.'s then?

■ Yeah there's three (3), three (3) spots up there and then there's a house right here.

WH Which would be on the corner of Shoemaker?

■ Yeah on the corner by the stop signs, it's in between right there and there's a trampoline out here and

WH Okay.

■ Yeah.

WH Would he be, uh does he work anywhere?

■ He's there.

WH Okay.

■ And his girlfriend, her kids probably.

WH Okay.

MK Thank you.

WH Anything else you think you need to ask us, tell us, excuse me, or ask us?

■ No.

WH My name again is Hanson this is Kirkpatrick, Sheriff's Office. Okay anything you need to ask Marvin?

MK No.

WH Okay we'll stop this at nine thirty five (9:35).

End of Transcript.

Transcribed on 8/2/2007 by [REDACTED] 0608.

HUMBOLDT COUNTY SHERIFF'S DEPARTMENT

CASE: 200703162
INTERVIEWER: Sergeant Wayne Hanson
SUBJECT: Attempt P.C. 187/ Officer Involved shooting.
STATEMENT OF: [REDACTED]
DATE & TIME: June 4th, 2007 6: 40 P.M.
LOCATION: [REDACTED] Hoopa, California.

ALSO PRESENT:

WH Wayne Hanson

[REDACTED]

WH The date is um June the fourth (4th) two thousand and seven (2007) approximately six forty (6:40) in the evening, I'm at um [REDACTED] and um, what's your first name again ma'am?

[REDACTED]

WH [REDACTED] residence, what's your address here?

[REDACTED] Uh post office box?

WH Well your physical address, I know it's a hard one (1)?

[REDACTED] Um

[REDACTED] Um we use [REDACTED].

WH [REDACTED].

[REDACTED] Mm hmm, cause I don't like to refer to [REDACTED]

[REDACTED] Yeah.

WH Okay and what's your P.O. Box?

■ [REDACTED]

WH [REDACTED]

■ Yeah.

WH Okay the reason I'm here is last night um your neighbor up there and he wasn't involved in it um [REDACTED] [REDACTED] was gone, but there was a gentleman in the house last night, at [REDACTED] [REDACTED] house that um fired some rounds, shot some round and our deputies returned fire but you weren't home last night you said you got back from a trip?

■ One thirty (0130) A.M. this morning.

WH One thirty (0130) this morning and this is Monday?

■ Yeah.

WH So obviously you didn't,

■ We, we left on Friday night at seven thirty (730) P.M. uh went to uh right around Salem, Sheridan, Oregon.

WH Mm hmm.

■ And then uh picked up our son, he goes to boarding school up there.

WH Okay so you left Friday night about seven (7 00) P.M. got back this morning about one thirty (1:30) on Monday, and you didn't have anybody staying at this house when you were gone?

■ (Inaudible).

WH Do you know a uh [REDACTED] by any chance?

■ Uh just by name that's all.

■ I know his mom.

WH Okay. And you haven't spoken to [REDACTED] [REDACTED] today or nothing like that, so (inaudible) with deputy, shots being fired you have no knowledge?

■ (Inaudible) yeah we weren't even here.

WH Okay ending the um tape at um eighteen forty two (1842) hours.

End of Transcript.

Transcribed on 7/30/07 by [REDACTED] 0608.

HUMBOLDT COUNTY SHERIFF'S DEPARTMENT

CASE: 200703162
INTERVIEWER: Sergeant Wayne Hanson
SUBJECT: Attempt P.C. 187/ Officer Involved shooting.
STATEMENT OF: [REDACTED]
DATE & TIME: June 5th, 2007 8:36 A.M.
LOCATION: [REDACTED] Hoopa, California.
ALSO PRESENT: Deputy Mark [REDACTED]

WH Wayne Hanson

MP Mark [REDACTED]
[REDACTED] [REDACTED]

WH Time is um eight thirty six (8:36) in the morning on June the fifth (5th) uh two thousand seven (2007), I'm at [REDACTED] house with Deputy [REDACTED] Sergeant Wayne Hanson um and I'm just going to ask you a couple quick questions [REDACTED] you know uh [REDACTED] then?

[REDACTED] Uh yeah I've never actually met him but I know of him.

WH Okay. The reason I'm here is um all day yesterday and the day before this is Tuesday, starting on Sunday there was a problem with your neighbors house, are you aware of what was going on up there?

[REDACTED] Yeah I figured it out.

WH Um let me ask you this on how did you figure out what was going on up there?

[REDACTED] Uh neighbors with scanners and stuff, it wasn't until about sundown, almost dark that a sheriff and uh tribal police came to evacuate me.

WH Oh was that on Sunday night?

[REDACTED] Yeah.

WH And why did they evacuate you?

■ Uh because shots were fired, but shots were fired around four (4) o'clock I believe too.

WH On, on Sunday?

■ Yeah.

WH Did you hear those shots?

■ Oh yeah, we always hear gun shots back there it was never surprise to hear gunshots.

WH How many gunshots did you hear on Sunday?

■ Sunday I think I believe I heard four (4) to five (5) shots the first time, and then,

WH Do you remember what time of day that was?

■ Uh I can't remember, my wife would know better because I sent her and the kids out of here.

WH Okay was it the four (4) or five (5) shots, was it like all in succession four (4) or five (5) shots?

■ Yes, yes, yes,

WH Or was there a lull between the shots?

■ No it seemed like succession, just one (1) right after another.

WH Could you tell different calibers or?

■ Uh not really I never paid, I was working on my truck so I, I heard the shots but

WH So you were outside?

■ Yeah.

WH And who, who was home with you?

■ My wife and my two (2) children.

WH Was your wife home?

■ Uh she went and took my son to school right now.

WH Okay. Um did you hear police sirens or anything like that?

█ Oh no, the only way I knew something was, uh sirens were coming up the hill is my wife, just after uh tribal police, we saw tribal police go by and uh we didn't think nothing of it because uh █ his nephew or something works for Tribal Police so he comes visit him sometimes.

WH Oh █ █ uh █

█ Yeah █, the one (1) behind,

WH Okay.

█ █ so it was never uncommon but my wife went to the store and she told me that two (2) uh sheriff's were coming up, full lights were coming up the hill and then actually I went outside and I was playing with my kids, I heard the sirens coming up.

WH Okay.

█ But by the time they got to the junction down here they didn't have no more sirens on.

WH Was that after you heard the shots?

█ Yeah.

WH The sheriff's cars were coming?

█ Yeah.

WH Okay.

█ I think that's when it was.

WH Okay.

█ I just can't remember.

WH Do you know a █

█ No I don't.

WH You don't know █ and █ █ normally lives up there with who?

█ Yeah with uh █

WH [REDACTED] his wife?

[REDACTED] Uh girlfriend.

WH Girlfriend. Anybody else there living with them?

[REDACTED] Uh the boy, [REDACTED]

WH And how old is [REDACTED]

[REDACTED] Uh he's lets see my son's seven (7) so he must be about nine (9) ten (10) I guess.

WH Okay. So on Sunday or um you heard the four (4) or five (5) shots, um you said that was in the afternoon, about what time?

[REDACTED] I can't remember, I mean all I can remember my father and my brother's they left around two (2) o'clock, they saw Tribal about three (3) three thirty (3:30), and then there was gunshots maybe I don't know I want to say four (4) or five (5) or something rather, so I, I don't know.

WH Okay. Um and then what happens next does a deputy come down and asks you later?

[REDACTED] No it wasn't until like after nine thirty (9:30) nine fifteen (9:15) cause uh it was just right after my brother and my, my brother called to let me know they got back home down in San Francisco.

WH Mm hmm.

[REDACTED] And then uh I was out on the front porch out here and that's when I looked over and I saw a sheriff and Hoopa tribal coming over to let me know.

WH What time was that?

[REDACTED] That was like I say after uh nine (9), nine (9) o'clock.

WH So did you hear any that one (1),

[REDACTED] Oh I heard a bunch of gunshots, uh I mean I heard the guy, I heard that kid hooping and hollering too you know.

WH Is that before the shots?

[REDACTED] That was after, during, you know.

WH What did you, could you tell what he was saying?

■ No I couldn't tell what he was saying you know just "who yeah", you know and that was about it.

WH Literally hooping?

■ Yeah just literally hooping and hollering so,

WH And so that, that was after you heard the shots?

■ Yeah that was, then there was a few more shots and then you know through the, I think if I remember I heard three (3) volley's of shots and the last time I heard uh, by this time there was a bunch of uh vehicles up here now,

WH Mm hmm.

■ So this had to be eight (8) o'clock,

WH So,

■ And that's when I heard these guys, well what I was out here doing first (1st), second (2nd) round I believe all those guys ducked you know and like I said you know when the cops came that night I said it ain't normal to hear gunshots back there, it wasn't normal, I mean it was always normal to hear gunshots back there,

WH Okay so you mean they always target practice,

■ Yeah because my wife's called Tribal Police and let them know because we'd hear fully automatic weapons going off back there.

WH Okay. Okay so

■ So that's when the Sheriff and the Tribal Police came I said hey man you guys got to watch it cause I know that guy has you know automatic weapons it wouldn't be, you know it wouldn't be uncommon to here, (inaudible) you know my wife would call in to Tribal Police and they'd say oh well it's he's hunting mountain Lion, I'm like okay, it's a mountain lion.

WH Oh. Yeah everybody always says stuff like that.

■ Yeah.

WH Um okay so let me back track so it's clear in my mind so on Sunday sometime, it's still daylight I assume?

■ Oh yeah like I said,

WH Four (4) or five (5) shots?

■ Yeah.

WH And then how much time goes between till you hear more shots?

■ Oh maybe an hour, two (2) hours you know.

WH And two (2) hours later how many shots did you hear?

■ Probably about four (4) or five (5) six (6) shots,

WH Okay.

■ And then all I know is you guys returned fire because I heard these guy say we returned fire, we returned fire.

WH How did you hear that?

■ I hear it, because they, I could hear them talking on the road up here.

WH Oh not the radio's but,

■ No (inaudible) yeah I heard you guys talking yeah then they were calling for roll call and so I could hear cause I was working on my truck.

WH Oh okay. So you could hear the officers?

■ I heard everything,

WH Saying that I fired?

■ Well yeah, we returned fire because they were talking on, he was talking on that he was talking to someone verbally on the radio so.

WH Okay and then you heard an officer ask for roll call?

■ Yeah.

WH I mean on the radio or just verbally?

■ Uh both.

WH Okay, it was at dark then?

■ Uh no still light out, I was still working on my truck so it was still light out.

WH Okay, okay after you hear that roll call, you, what else do you hear?

■ Uh that's all I heard after that that, then I start um

WH Was he hooping and hollering after that?

■ At that point to yeah he was still you know every time he would shoot, you would hear him yelling and whatever you know. I couldn't hear what exactly he was yelling at that time so.

WH Okay. You hear uh Law Enforcement announcing "Police" "Sheriff's Office" anything like that come out or anything like "come out" or anything like that.

■ Oh I heard yeah the, the loud speaker?

WH Yeah

■ Yeah I heard that.

WH What, what did you hear?

■ Um just them telling him to come out and then I remember something they were saying the door was opening, be prepared or something rather he's coming out or he's going, ■ going back in, so that's all I heard.

WH Okay can you remember the exact words on the loud speaker, what they said?

■ On no, no, no.

WH Okay.

■ All I know is reference just,

WH Okay.

■ You know coming out going back in, um just the roll call.

WH And where, where your house is at all you see, you can't physically see much can you?

■ Not unless I go back this way.

WH Did you do that on Sunday?

■ No

WH Oh okay.

■ I just, I know line of sight, guns.

WH Common, common sense.

■ So I'm staying over here working, you know I knew I was safe over here.

WH Okay.

■ So no I never went over there.

WH It all sounded like rifle fire to you, the shooting?

■ Uh no I heard a lot of pistol firing and yesterday morning we were, I came back to take a shower and get some more clothes.

WH Yeah.

■ And uh didn't sound like shotgun, didn't sound like pistol and there were a lot of volley's (inaudible) and I was next door with my brother in law.

WH What time was that yesterday?

■ That would be approximately nine (9) o'clock I guess in the morning.

WH Okay um,

■ I believe it was nine (9) o'clock.

MP Do you have any idea who was up there at that time?

■ No. By this time all the cars that were here were all cleared out, um looked like one (1) or two (2) cars.

WH Mm hmm and nine (9) o'clock yesterday as in Monday morning?

■ Yeah.

WH Okay.

■ Then I just kept hearing thud, thud, thud, thud, you know it wasn't like a shotgun you know.

WH It was um later in the morning we used chemical agents,

■ Well maybe that's when it was, I don't know I just,

WH Kind of like a thud.

■ Yeah it was just a thud, thud, it sounded like low velocity.

WH Yeah that's what we were launching, chemical agents.

■ Mm hmm.

WH How do you, did you hear a lot of those rounds?

■ Yeah.

WH Yeah that was chemical agents yesterday.

■ Yeah they were just continually that's why I you know I was surprised that I didn't hear no return fire

WH Okay.

■ You know.

WH Okay when the officers come down Sunday night and asked you and your family to evacuate,

■ Well my family were already gone.

WH Okay but they came down and they asked you to evacuate?

■ Yeah.

WH They tell you why they want you to evacuate?

■ Oh yeah hostage, possible suicidal situation and uh, you know they only think I didn't like about it was uh, when they came the, the Sheriff Department was, to me he seemed very

respectful you know but it was just like the Tribal guy followed me all the way threw my own house you know while I'm getting kids clothes and sleeping bags and stuff you know and then I just kind of you know that's what uh my wife's been upset is you know how come they didn't come down in the first situation saying well this is we're trying to handle it now you know maybe eventually we're gonna have to have a full evacuation you know please be prepared.

WH Oh when it happened?

■ When it started happening it would have been nice.

WH Well when, when it started happening um

■ I know you know but I mean when you have vehicles backed up all the way there and you got stuff down the road that way, come on you can afford one (1) person for public safety.

WH Yeah I, I know I mean it's always hind sights are always better than foresight but what happened is one (1) of the officer, a couple of the officers were actually pinned down in there um they couldn't move um in a very bad predicament.

■ Well yeah I mean that whole situation where his house is he has three hundred and sixty (360) degree view.

WH Yeah.

■ Everywhere that's why I knew you guys were in trouble you know.

WH Yeah, so, so, so it was kind of tense for a while.

■ Yeah I understand.

WH Just the oversight by somebody.

■ But you know well see the thing is that's why I'm saying okay the Tribal Police, you know I have a issue with the Tribal Police, I'm a Hoopa Tribal member and I just you know don't think they're efficient. I use to like to hear when my said other tribes use to come here and work as police officers you know justice is blind when you don't have relatives here.

WH Yeah.

■ And that's the way I view it you know how come they don't do that with the tribal police so?

WH I don't know.

■ That's all I'm going to say about that but I mean at least you had the local resources of the Tribal Police Department they were up there they could have come to these two (2) house, if not to my wife's grandmothers house down here below and he aunts house and at least let us know.

WH Yeah every, I've been law enforcement for quite a few years, everything's a training issue, I mean, I mean it should be brought up in the future,

■ But I mean you know everything with law enforcement and any kind of entity like that is to serve and protect the community and we are the community.

WH Well absolutely as I said it's a training issue, you just have to be, bring it to the council's

■ I don't know my, my first thing is you know worrying about safety, I mean with the job I work in there's some hot spots, you know I deal with nuclear I deal with a lot of stuff and my first thing is getting everybody out when there's a situation and me last.

WH Yeah.

■ And that's just me working with a crew you know I've run a hundred (100) crew, hundred (100) man crew,

WH Yeah.

■ And then my first thing is always been safety.

WH Yeah well see to backtrack I wasn't here that night we got called out um Deputy ■ and I did later but the officer were getting on scene, there was a couple officers that are pinned down, they can't move safety,

■ Mm hmm.

■ They're trying to set up a perimeter in that house; it takes a lot of guy's perimeters to make sure he doesn't escape.

■ Oh yeah I understand.

WH So there's, they're trying to set up the northeast, west, south perimeter in the house and um should have came down here quicker you know,

■ Well what I'm just saying, I'm not blaming the Sheriff's Department, I'm blaming really the Tribal Police Department.

WH Yeah.

■ They should have been worried about the people that live here.

WH Yeah.

■ You know and I understand that you guys got your work to do you know, it's just I, I don't understand because I mean, isn't the right protocol that the Tribal Police would have been first on the scene and then when the situation blew up like it did you guys would be taking over, Humboldt County?

WH Yeah that's what happened.

■ Yeah see then how come they didn't fall back and,

MP We, we were first on scene.

WH No it was um,

■ Tribal Police was.

WH No it was um Tribal, Yurok and Tribal were first on scene.

■ Yeah.

WH You know it was helter skelter you know um somebody shooting at you and I'm not making excuses.

■ Well I mean I've been shot at, I've had pistols pushed in my face

WH Yeah, yeah I'm not making excuses but um,

■ But you know everyone around me is more important to me.

WH Oh, oh absolutely and, and

■ I'm not even law enforcement.

WH I can bring up your concerns, which I totally understand.

■ And that's what my wife is really upset about.

WH Yeah,

■ You know we got two (2) kids out here playing with a kite at the time.

WH What, what time did they come tell, officer show up?

█ Like I said it was just right after the sun had set so it was around sunset's about eight forty (8:40) so it was about nine (9),

WH They came down here and told you that.

█ I would say approximately nine (9) o'clock.

WH About nine (9) o'clock somebody finally came to your house?

█ Yeah they two (2) guys with uh guns came walking this way.

WH And so you (inaudible).

█ Yeah and then the one (1) guy, the Sheriff he was cool, he sat out here you know while I was getting my stuff and then uh Tribal Police man I mean followed me there every room and I'm just getting,

WH Do you know what his name was?

█ No I could easily pick him out, he had funny colored eyes and light, light hair but big guy you know that's the only thing I felt you know was like woo you know

WH Yeah.

█ I was just trying to get out you know.

WH Yeah.

█ You know and it's just me, I would have spent the night here.

WH Cause, cause you already sent your wife and kids (inaudible).

█ Yeah my wife and kids were already down at their, and then uh he asked for phone numbers you know when the situation was over that he was going to tell us to come back so I gave him my wife's cell phone number, I gave him my wife's grandmothers number where we were staying.

WH What's your wife's first name?

█ [REDACTED]

WH And same last name?

■ Yes.

WH And what's her middle name?

■ ██████████

WH Spelling?

■ ████████████████

WH And her date of birth?

■ ████████████████████████████████████████████

WH (Inaudible) remember the birthday.

■ I only remember cause her and my son have the same, same day.

WH Let, let me write my cell number on this cause I, I got to speak to your wife too, uh

■ She might be back here shortly so.

WH Okay well I'm just gonna be up the hill, I've got to talk other neighbors and then come back.

■ Okay.

WH I'll write my cell number cause it, see what she saw or heard.

■ Yeah no I don't think she really saw anything or heard.

WH What's going on.

■ It was me cause I was outside working you know I was in between my shed and back to this side of the house working on my truck so.

WH So when you left Sunday about nine (9) o'clock you said um

■ Yeah.

WH When did you come back home then?

■ Oh I came back home the next morning I mean you guys were all repositioned differently by this time.

WH Did you see smoke coming from?

■ Oh not yet we came home about eight o'clock, seven (7) o'clock, no yeah it had to be about seven thirty (7:30) we came back up cause I took a,

WH Last night?

■ No this morning, yesterday morning excuse me Monday morning. Cause I took a shower, my wife took a shower then we got some more clothes.

WH Uh huh.

■ And a couple blankets and then we walked out of here to next door.

WH Okay.

■ Then we took our kids to school, I dropped,

WH Oh so you didn't spend last night?

■ No, no cause we were evacuated.

WH Oh then what time did you get back today?

■ Like I said, oh today uh well the only reason why the neighbors told us cause they heard on the scanner it was all over and then from people down at the store last night about I'd say, eighteen hundred (1800).

WH Did you see any fire or smoke coming from ■ house?

■ Oh it was already standing over here when it started firing and smoking, see I came up here,

WH Cause you were standing right at the next house?

■ I was uh next door at my in laws, my father, father and mother in laws over here.

WH So you saw the,

■ Because my wife from down the valley saw the smoke and see I'm worried about this grass being somewhat dry

WH Right.

Coming this way, and I know the wind blows at night in the evening time so that's why I stood over there and waited just in case the fire started coming this way. Then I seen the fire department both truck come over and wait and then I heard them talking about you know wait till it's safe, we don't care if it's fully engulfed you guys go when we tell you to go you know and then I figure when they left, they were all right you know every, something happened.

WH Yeah we're concerned cause it is (inaudible).

Oh yeah I understand, I understand.

WH Okay.

I understand.

WH Um okay, you got anything else that I forget to ask?

No it's just like I said my main concern was you know the, the, the local, at least the local the tribal should have came told us you know get ready to leave in case you have to leave.

WH Right.

You know what I mean like that you know that would have been nice, that's the only thing.

WH Oh, oh, I agree with you one hundred percent (100%) but, but, um it needs to be corrected so it doesn't happen in the future but I agree with you a hundred percent (100%).

Yeah so no I that's, that's my biggest complaint,

MP It sounds like you guys never got a call back after it was over?

No we've never got a call back so, technically we could still be staying somewhere else, you know waiting for the call back so.

WH Yeah.

MP (Inaudible) somewhere.

WH I, I talked to your in laws last night see what saw or heard and they said they were out of town?

■ Yeah they were in Oregon getting there uh boy he goes to school up north so

WH Right.

■ There were out of town.

WH Yeah. We, we're going to be here, or Sheriff's office is going to be here through out the day up there, it's completely safe,

■ Okay.

WH Um he was found deceased inside the house.

■ He ended up taking his own life yeah.

WH We don't know yet um the coroner took his body.

■ Oh okay.

WH Um so there will be an autopsy but uh

■ Yeah I figured three (3) situations that were going to happen, that was one (1) of them.

WH Oh it's tragic.

■ Yeah.

WH It's tragic.

■ I, I don't care cause I mean this is, I think you know this had to happen for a reason and a lot of people complained and nothing happened and until it came this far you know.

WH And so you didn't know him but you just heard rumors about ■ or?

■ Yeah so but I'm talking about the neighbors so I hope they don't be played as the ■ cause they're not a ■

WH Oh ■ ■

■ Mm hmm, they're not a ■ you know that's all I have to say about that.

WH Okay. Well the house is completely destroyed by fire.

■ Okay.

WH So that will have to resolve it's self where they're going to live. Okay uh yeah when your wife comes home I need to talk to her it won't take long.

█ Okay.

WH Um thank you for your time and I'm going to stop the tape at eight fifty four (8:54).

End of transcript.

Transcribed on 7/30/2007 by █ 0608.

HUMBOLDT COUNTY SHERIFF'S DEPARTMENT

CASE: 200703162
INTERVIEWER: Sergeant Wayne Hanson
SUBJECT: Attempt P.C. 187/ Officer Involved shooting.
STATEMENT OF: [REDACTED] [REDACTED]
DATE & TIME: June 5th, 2007 9:55 A.M.
LOCATION: [REDACTED], Hoopa, California

ALSO PRESENT:

WH Wayne Hanson

[REDACTED] [REDACTED] [REDACTED]
WH This is uh Sergeant Wayne Hanson, its uh June the fifth (5th) two thousand seven (2007) about nine fifty five (9:55) in the morning, I'm at uh Miss [REDACTED] house which is located at [REDACTED]

[REDACTED] Mm hmm.

WH Okay uh good morning, how are you?

[REDACTED] Fine.

WH Uh the reason I'm here there was an incident uh started on Sunday with your neighbor up, up top of the hill, [REDACTED] [REDACTED] house.

[REDACTED] Mm hmm. Yes.

WH Um okay. I just need, sometime Sunday you became aware of a problem going on up at your neighbors house, [REDACTED] [REDACTED]

[REDACTED] Did I become aware?

WH Yeah, yeah.

[REDACTED] By people calling to tell me there was a problem.

WH Okay and what, what were people calling to tell you what was going on?

■ Just that there was maybe a hostage situation or something and they were all speculation.

WH Okay was it friends and family that was listening to the scanner?

■ Listening to the scanner and all we seen were cops right up here behind our house.

WH Well what time did you see the cops above your house, remember, I mean was it,

■ Uh well I went down the hill at um, down to the valley at gosh three thirty (3:30), three forty (3:40).

WH In the afternoon?

■ Yeah I was trying to make back (inaudible)

WH Okay.

■ (Inaudible) but anyways I went down the hill and I called my husband said that Tribal Police was flying up the hill with lights, which is very unusual for our area and, and to watch see where they go and that was it, that's all we knew.

WH Okay did you, you didn't hear any um gunshots,

■ I didn't hear gunshots until six thirty (6:30).

WH Six thirty (6:30) on Sunday night?

■ Sunday evening yeah.

WH And where were you on Sunday evening when you heard them?

■ I was right here,

WH Inside your house?

■ Yeah and I looked up the hill and I seen cops ducking and shots fired.

WH (Inaudible)

■ Cops ducking?

WH Ducking, oh you physically could see them?

■ Yeah right here.

WH How many cops did you see?

■ I think probably two (2) one (1) for sure, two (2).

WH And how many, how many shots did you hear?

■ I don't know, I just.

WH More than one (1).

■ Probably more than one (1).

WH Okay um did you hear any yelling?

■ No.

WH Um did you hear?

■ Just my husband saying go, go, go get out of here so,

WH Okay. Um do you know who ■■■■■ is have you heard that name before?

■ You know I've probably, if I know, I think I know when he was a kid,

WH Mm hmm.

■ When I last time I knew him.

WH But you normally, you wouldn't normally see him in this neighborhood?

■ Uh uh, I didn't.

WH Or this surrounds?

■ Nope.

WH Um and you know ■■■■■ owns the house above you?

■ Yes. I've known him since I was a kid.

WH How long have you lived here?

■ I've was born and raised in this house next door.

WH Oh where you're in laws are at?

■ No that's his in laws, those are my parents.

WH Excuse me, your parents, yeah his in laws.

■ Yeah.

WH Okay.

■ And I use to be friends with his mom and ■ and um so I knew ■ since I was a kid.

WH Okay. So after you hear the uh you know a couple shots, one (1) shot um were you here, you weren't here when the officers came and said it would be a good idea to leave, you're husband said, why don't you go ahead and get out of here?

■ Uh-uh nope, which I was pretty annoyed with that it waited till nine (9).

WH Right that's what he told me so,

■ Mm hmm I was really,

WH So after you see the officers ducking you hear the shot, your husband says get out of here.

■ Just go.

WH So you took your daughter, took off in your car?

■ And our son.

WH And your son took off in the car?

■ Uh huh took off and went down the hill,

WH Okay.

■ And we just kind of waited, he stayed cause he figured that it wouldn't be you know, we'd be able to come home that night and everything would be fine, and then the officer showed up and but that's where my problem lies is that it was nine (9) whatever nine (9) something

where they came and obviously shots were fired at six thirty (6:30), the only reason we knew what was going on is because with scanners you know and there's

WH Right.

■ Why didn't somebody come and they seen us running around outside, the officers did so

WH Yeah I wasn't here, I got a phone call um from my house that evening, I'll go ahead and stop this tape at almost ten (10) o'clock.

End of transcript.

Transcribed on 7/25/2007 by ■ 0608.

HUMBOLDT COUNTY SHERIFF'S DEPARTMENT

CASE: 200703162
INTERVIEWER: Sergeant Wayne Hanson
SUBJECT: Attempt P.C. 187/ Officer Involved shooting.
STATEMENT OF: Sergeant Mike Fridley, #1
DATE & TIME: June 5th, 2007 @ 1325 hours.
LOCATION: Hoopa Substation, Hoopa, California

ALSO PRESENT:

WH Wayne Hanson
MF Mike Fridley

WH This is Sergeant Wayne Hanson, it's um June the fifth (5th), two thousand seven (2007), approximately uh thirteen twenty five hours, I'm at the Hoopa Substation with Sergeant Mike Fridley uh discussing uh an incident that occurred in Hoopa on Sunday uh and this is case two thousand seven three one six two (20073162). This incident occurred at [REDACTED] residence uh in Hoopa. Mike it came to my attention today through um D.A. Investigator Mike Hislop that um you had some tape recording um that you took on Sunday regarding this incident at [REDACTED] residence, shots fired?

MF Yes.

WH And uh you currently a um hostage negotiator for the Humboldt County Sheriff's Office?

MF Yes I am.

WH Okay, I'll let you go ahead and narrate regarding uh you're on scene at [REDACTED] residence uh on duty in full Sheriff's Department uniform?

MF Yes.

WH In a marked Sheriff's Department truck, excuse me, uh vehicle, patrol vehicle?

MF No I was hiding behind a Hoopa Tribal Police Vehicle, it's marked, Expedition.

WH Okay, it has a light bar on top?

MF No they, I don't believe they have light bars.

WH Okay and you're arrived at um scene because what type of a call?

MF Um that they had a stand off situation and I was requested to respond to negotiate.

WH Okay and Detective um Steve Quenell already spoke to you on late Sunday night or early Monday morning?

MF Yes.

WH Took a statement from you?

MF Yes, yes sir.

WH Okay. Um okay while you're on scene, you have a um cassette recorder with you?

MF Yes.

WH Okay and why don't you just go ahead and just tell me uh what happen, what time uh it was that this was all transpiring?

MF Okay uh it's pretty standard for the Sheriff's Department, I don't know that there's a policy but we record our negotiations so that's why I had the tape recorder going is the incident, as we would negotiate with the [REDACTED] we'd turn the tape on, I'd try to notate the time, negotiator uh tape what I was saying to him and at the end of that I would turn the tape off, try to, if I could remember say the time when I stopped, so the tape kind of bounces around and there's a lot of dead space in it but that's pretty much the procedure is just for uh later on we can tape record the, the negotiations and to critique it and maybe possibly for litigation later down the road. Um at this point where this incident was happening there was two (2) Hoopa Tribal units parked below the residence, um there was one (1) closer to the residence and one (1) further back, um I was using the second (2nd) vehicle back, Jason Daniels and I, Deputy Jason Daniels, he was acting as my couch, I was the primary negotiator, we were on the drivers side of the vehicle, using the engine block as cover and kneeling down um and the S.E. T. Team members were up using the front vehicle as cover um at some point near twenty fifty three (2053) hours, I remember somebody yelling that he was opening one (1) of the windows, so when I heard that I turned the tape back on, I wanted to start negotiating with him again cause I knew that he was at a window and he could hear me and we were using the Public Address System.

WH Is that on the patrol vehicle?

MF On, on the patrol vehicle, on the second (2nd) patrol vehicle.

WH And about how far from your patrol vehicle to the house were you in feet?

MF I,

WH Ball park.

MF It's probably about fifty (50) yards I don't know how many feet it was.

WH Okay.

MF Uh when the window, I didn't see the window open cause I was obviously in my position behind the, the vehicle, I turned the tape on um and I, I tried to contact him, and as soon as I started to talk to him, I heard, I didn't really hear the shot, I heard the bullet come near very close to where I was sitting at and go into the brush on the side of the road,

WH (Inaudible).

Mf Just, just past me, it would be on the, the south side of the road, I heard it go through the brush it made like kind of a whizzing sound as it went past me.

WH And the patrol vehicle that you're trying to obtain cover behind, you're south of the residence, would be your, your position?

MF Yeah it would be south, south east.

WH And that sound that you heard um you used the word "whizzing" have you heard that before,

MF Yes.

WH Uh around?

MF Yes.

WH In your training?

MF Yes and I mean it was, I, you could hear the shot and the whizzing almost in one (1) one (1) constant sound, it was like fluid.

WH And you captured that sound on a tape recorder?

MF Yes, yes as soon as I heard that I yelled "shoots fired".

WH And then what happened after you heard shots fired?

MF Within a second or two (2) I heard the, the what I, the S.E.T. Team that was in front of me returned fire.

WH Okay and Detective Quenell already spoke to you about that?

MF Yeah.

WH Okay and then a point in time you, you, you took um numerous tapes of your negotiations?

MF Yes there's uh six (6) tapes total, I secured those from the vehicle when the, at the conclusion of the incident, I brought them back to the, the Hoopa Station and uh when I was here I thought maybe that I had captured part of the shooting on the tapes, so I played back the tapes until I got to the tape marked "tape number one (1)" and it's on side B uh you can hear basically what I just described to you, it's captured on the tape.

WH Okay and then you booked those into evidence at the Hoopa Sub?

MF Yes.

WH And then uh today's date and time on June the fifth (5th) two thousand seven (2007) you're going to give those tapes to me and I'm going to transport them to our evidence locker at Main Station in Eureka and place them into evidence. Um okay and there's several hours worth of recordings on these tapes?

MF Yes there are ninety (90) minute tapes so, I think all of them but the last one (1) are completely full.

WH Okay um that's about all I have, anything else you think we need to add in this?

MF Uh that if I was asked to estimate how close, I heard that bullet go through the brush near us that it was within five (5) feet of where I was at.

WH Okay and you're by uh,

MF By the sound of the bullet going through the bushes, I heard it going into the bushes and

WH Okay.

MF I would estimate that it was within five (5) feet of where I was at.

WH And how long can you estimate while you're on scene that the time, once you arrived till the shoots fired at you, was it five (5) minutes, twenty (20) minutes, an hour, two (2)?

MF Oh we'd been there several hours.

WH before the shot was fired and the negotiations several hours with uh the [REDACTED]

MF Yes.

WH Who is the [REDACTED] that you believe (inaudible).

MF [REDACTED]

WH Okay. That's about all I have. Ending tape at thirteen thirty two (1332) hours.

End of transcript.

Transcribed on 7/19/2007 by [REDACTED] 0608.

HUMBOLDT COUNTY SHERIFF'S DEPARTMENT

CASE: 200703162
INTERVIEWER: Sergeant Wayne Hanson
SUBJECT: Attempt P.C. 187/ Officer Involved shooting.
STATEMENT OF: Sergeant Mike Fridley, #2.
DATE & TIME: June 5th, 2007 @ 1445 pm.
LOCATION: Hoopa Substation, Hoopa California

ALSO PRESENT:

WH Wayne Hanson
MF Mike Fridley

WH This is Sergeant Wayne Hanson date is um June the fifth (5th) two thousand seven (2007) it's fourteen forty five (1445) hours, I'm at Hoopa Substation with Sergeant Mike Fridley discussing case two thousand seven thirty one sixty two (20073162) this is the second (2nd) interview with um Sergeant Fridley today um regarding what happened at um [REDACTED] residence um continuation from Sunday and Monday on June the fourth (4th), actually June the third (3rd) June the fourth (4th) a continuation, Mike um after Sunday's event um where (inaudible) the tapes where "shot's fired" are gonna be heard on your tape, you go home at uh a certain time on Monday morning to

MF Yes.

WH To get some rest and then you respond back to the incident on Monday.

MF Monday morning yes.

WH On June the fourth (4th), what time was that?

MF I came to work at eight (8) and I drove pretty much straight up there from (inaudible).

WH Okay and um your duty again on that date was the negotiator for Humboldt County Sheriff's Office?

MF Yes.

WH Okay and you're on scene for about how long uh your on scene on Monday and then you're witnessing our uh special enforcement team deploying chemical agents, is that correct?

MF Yes.

WH Do you remember what time that all started?

MF I do not know. What had happened was those, the special enforcement team were using protective masks, chemical masks, um and they weren't able to talk into the radio's so I was acting as the, the calm person, letting the command post know what was going on so I watched them insert the gas and up, updated the command posts as to what was going on with them.

WH Oh so you were relaying?

MF Relaying. So I had eyes on them the whole situation when they, (inaudible) gassing.

WH And you're positioned again about how far from the structure where [REDACTED]

MF Still back at the second (2nd) vehicle like uh where I was negotiating from, if I guessed it was somewhere around fifty (50) yards.

WH Okay and while you're there um you're on scene for how long, hours before a Special Enforcement Team is deploying chemical agent?

MF I think it was probably a couple of hours, I didn't really look at my watch.

WH And during those couple of hours before uh chemical agents are deployed um you're on the loud speaker uh advising the subject inside to please come out, surrender?

MF Yes.

WH Do you know how many times you uh?

MF I couldn't tell you, um I tried to do it at least every ten (10) or fifteen (15) minutes, sometimes it would go longer, I would talk for three (3) or four (4) or five (5) minutes and then stop and just pick it back up you know another fifteen (15) twenty (20) minutes after that.

WH And Lieutenant Cavinta was uh contacting the radio and also requesting you other times to,

MF Yes.

WH Do that also wasn't he. Okay you're on scene for several hours um negotiating over a loud speaker requesting the guy to please surrender and at a certain point um Lieutenant Cavinta authorized the use of chemical agents as a tool to make the [REDACTED] come out?

MF Yes.

WH Okay and just tell me what you witnessed when chemical agents were being deployed.

MF They were uh two (2) different types of chemical agents, there was, I guess they're called ferret rounds that you shot from a little short shotgun looking thing. I saw them shot those toward the windows and try to hit threw the windows on side four (4).

WH Which is the south side?

MF Yeah and they had them had them mark as window four "A" (4 A) and four "B" (4 B) they were trying to shoot, shoot threw those, they also shoot uh some shotgun rounds, I don't know what those are called, gas rounds?

WH Yeah. It, it would be a twelve (12) gauge and then uh are you familiar with a thirty seven (37) millimeter?

MF Yeah.

WH Did you see both of those?

MF Yes.

WH Being deployed. Can you tell which um S.E.T. members were deploying them?

MF I saw Deputy Brian Taylor and I believe it was Deputy Jamie Barney.

WH Okay. And um this transpires for quite a while?

MF Yes. It was in conjunction with volleys of gas that were being introduced from the other side of the house as well, I'm not sure, I never got to see that so I don't know which what, what windows or side of the house they were actually shooting at but I could hear the radio traffic they were trying to coordinate the two (2) volley's together, they would, I mean one (1) would go and there would be a time and then the other one (1) would go.

WH Okay during this time frame do you hear um any voices or see any movement, or hear any movement from inside the, the structure?

MF I did not.

WH Is there a point in time that um, um a couple deputies approach the house with a um ballistic blanket?

MF Yes.

WH Okay why don't you tell me what you saw there?

MF That's the point where I was doing the relay that I was telling you about uh several of the S.E.T. Team members when up to the house on the south side, they, they were calling it side four (4).

WH Can you tell which members those were?

MF Uh I couldn't tell you exactly, I saw Sergeant Quenell, Deputy Brian Taylor, Deputy Jesse Taylor, Deputy Blake Massaro and Deputy Barney, those are the one's (1's) that I seem to remember going up there. I don't know who did the introduced the, the gas cause I couldn't tell from the distance.

WH And all these deputies are positioned behind a large uh ballistic blanket for protection?

MF Yes.

WH And what kind of gas did they introduce this time?

MF It was a hand held canister, I don't, I'm not a chemical admissions person,

WH Okay.

MF It's just like a grenade top, you pull the pin throw it and um I saw them throw at least one (1) canister into the first window and then they move to window "B" which is on the corner, it would be the south east corner and they, I saw at least one (1) canister placed in that window, as soon as those went off, I saw white smoke come from outside the house, or come out the windows.

WH Did they have to break the windows to put these things in or do you recall?

MF I believe there were holes in there already from the ferret rounds and the shotgun rounds, they were able to just throw them through the open windows.

WH Yeah we're talking about side four (4) windows "A" and window "B"?

MF Yes.

WH And can you recall a total of how many canisters were put in each window?

MF I think there was two (2) in each one (1). They placed two (2) canisters, I saw at least one (1) I'm thinking it was two (2) in each one (1) but I'm not one hundred (100 %) percent sure.

WH Okay. And you said you're not sure which deputy um put them in the windows. After the last canisters put in the window you're seeing volumes of white smoke or what are you seeing?

MF Yes white smoke coming from both window "A" and "B" um and then the S.E.T. Team retreated and the whole time I was updating the command post you know what was happening, smoke was introduced, the team was half way back um and then they made it back to the front of the tribal rig, that uh was closest to the, the house.

WH And then uh what happens next, is the period of time you see a different color smoke?

MF Uh eventually the white smoke stopped and there was no smoke at all, and from the point that there was no smoke at all till I'm guessing cause I didn't look at my watch was probably five (5) to ten (10) minutes, more closer to five (5) I started to see uh black colored smoke coming from window "B" which is on the, it would be on the three (3) four (4) corner,

WH Okay.

MF Um and it started to get thicker and thicker and then smoke started to come out of window "A".

WH Okay

MF And it,

WH You mean a large volume?

MF It turned white, it turned black, it was a large volume then it would, like almost slow down and then it would puff out and then for a long time it was just smoke coming out of the house, um I got on the P.A. numerous times and, and told [REDACTED] or I tried to tell [REDACTED] that we thought the house was on fire and they needed to get out and um, eventually we could see flames, or I could see flames coming out of window "B", and again I got on the P.A. many, many times and told them the house was on fire and you needed to get out and um and the fire just kind of progressed, just kept getting worse and worse and worse, I could hear what sounded like um rounds going off, popping in the fire.

WH Okay and you weren't sure if that was heat induced or somebody shooting?

MF Yeah I don't know if they were shot or yeah burning up?

WH But multiple um rounds going off?

MF Yeah.

WH From the time of the black smoke until you see flames um and uh the structure looks like it's fully engulfed, do you have a time estimate?

MF For fully engulfed?

WH Yeah ballpark?

MF Uh I probably thirty (30) to forty five (45) minutes, like I said I wasn't looking at my watch but I remember it was take took a long time that but it just smoked for a long time.

WH Okay and again you never heard any voice from anybody inside and no doors open up, nobody attempted to come out?

MF No. At one (1) point when the it was still just black smoke we heard, or I heard some kind of a pop or a bang come from window "B" area, I don't know if it was a gun shot or something popping in the fire, or what but it was a, a popping sound.

WH Okay. And then um uh a point in time, were you there when the fire department uh approaches the structure to put it out?

MF Yes.

WH And um our S.E.T. Team was with the, were they with the uh fire department for protection when they approached the structure?

MF Um I believe it was the Pelican Bay S.E.T. Team escorted the, the fire trucks up.

WH For their safety?

MF Yeah.

WH Okay um because we still don't know the uh where the [REDACTED] is at. Okay anything else you need to add about?

MF Well we could only see the fire on our side of the house, I don't know what it did to the other side.

WH Cause of your position on the south side?

MF Yes.

WH And with you that day is, anybody else with you as a negotiator?

MF No I was by myself.

WH Okay and that's all I can think of.

MF Okay.

WH Ending tape at um thirty fifty five (1355) hours.

End of transcript.

Transcribed on 7/24/07 by [REDACTED] 0608.

HUMBOLDT COUNTY SHERIFF'S DEPARTMENT

CASE: 200703162
INTERVIEWER: Rich Schlesiger, Detective
SUBJECT:
STATEMENT OF: [REDACTED]
DATE & TIME: June 3, 2007 @ 1845 hrs.
LOCATION: Hoopa, California

ALSO PRESENT:

RS Rich Schlesiger
[REDACTED] [REDACTED]

[REDACTED] (Inaudible).

RS Okay.

[REDACTED] Apparently I heard he hasn't been taking it and,

RS Okay, sir what's your, let me get the date here, June third (3rd) two thousand and seven (2007), time eighteen forty five (1845). What's your first name?

[REDACTED] [REDACTED]
RS What's your middle name?

[REDACTED] Middle name, [REDACTED]

RS You go by [REDACTED]?

[REDACTED] [REDACTED]
RS. [REDACTED]

[REDACTED] Yeah. [REDACTED]

RS What's your date of birth?

██████████

RS Where do you live at in Hoopa?

██████████ I live on Tish Tang Road.

RS What's your P.O. Box?

██████████) Hoopa.

UF (Inaudible) sent me down here to talk to you?

RS Yeah, go back up there and I'll talk to you, talk to you after I'm done talking to ██████████

UF Okay.

RS Okay ██████████ how did you hear this was all going about?

██████████ I had to work today, I work for the Fisheries Department, due the net harvest, anyway I stopped at the store after work and my other boy the, her and I have four (4) boys together

RS Okay.

██████████ And my youngest boy ██████████ is like,

RS What's her name?

██████████ Her name's ██████████

RS ██████████ and you're, you're, is it ██████████ e or ██████████?

██████████

RS ██████████ dad?

██████████ Yeah.

RS Okay.

██████████ Her and I have four (4) boys together and then I have two (2) other younger boys.

RS Okay. And, and with [REDACTED] uh it sounds like uh he, from what I heard, is he was a [REDACTED]?

[REDACTED] I guess.

RS Okay.

[REDACTED] That's what I heard I mean, (inaudible) say I mean she doesn't, we've been back in ninety five (95) ninety six (96) divorced I mean for quite a while and uh she doesn't really include me with what's going on.

RS Okay.

[REDACTED] You know, she's basically, we divorced, [REDACTED] was in like in the eighth (8th) grade and you know try to turn all my kids against me, I mean, natural, normal,

RS Okay.

[REDACTED] You know divorce thing from there he went from bad to worst and,

RS When, when's the last time you talked with [REDACTED]

[REDACTED] I talked to [REDACTED]; you know I was trying to think of that on the way up, maybe about a week ago.

RS Okay how was he then?

[REDACTED] Uh I, I don't know if this was the last time, but the time I seen him he was with that guy up there in the car, [REDACTED] and he's not a very good character,

RS No.

[REDACTED] In my opinion.

RS I know who you're talking about.

[REDACTED] You know, anyway he was standing over at the seventy six (76) station and he had a lunch pail on his hand and I was pulling out, he said "oh what's up pop" or something like that, I said just getting some lunch, he said I got my lunch right here, tuna, it's like man [REDACTED] you know I thought to myself, come on son you know.

RS And you mentioned something, he wasn't looking good?

█ No he was looking all scraggly whiskers, last time I seen him and he's lost a lot of weight, you know and he's got uh went recently got a part of a big tattoo on his chest and he knows that you know (inaudible) big tattoo's on him and he knows I don't care for it.

RS What about, okay, what about █?

█ What do you mean, do he do them?

RS Yeah.

█ I'm sure he does them.

RS What kind?

█ █

RS Okay. What makes you think that's what he does?

█ Uh I don't know, just cause uh, just kind █ I mean I don't know if it's that █ or I mean, and I haven't seen him do it, I see,

RS You just suspected it?

█ Yeah I mean I've did it before I mean

RS Mm hmm.

█ And I know,

RS And you realize what █ and █.

█ Well I don't imagine it is, but I mean, I, I, I, you know I don't have █ but I know █ and I was on it for awhile you know,

RS You know the effects of it.

█ I know I mean it makes you uh think █ you know what I mean █.

RS What about um, do you know █?

█ █ I think. Yeah his mother would probably know she's got all the █ and all that. I mean I just, I just, you know in my opinion you know █ he'd never come around.

UM Would you see if you can get these people preferably to leave?

RS Okay.

UM Since we've got an active shooter, he's already fired twice.

RS Okay.

UM And (inaudible) if they've got family, friends or somebody they can go to and a phone number so we can get them notified when the coast is clear.

RS Okay.

UM So.

█ These people?

UM Yeah, them and the other guy down there. So he's already shot twice I guess he hit two (2) cars.

RS Okay.

UM And he does have one (1) rifle so we don't want anybody else getting hurt.

RS Okay.

UM I'm going to take █ up to █.

RS Okay.

UM So if you can work on the.

RS I got one (1) more person to talk to then I'll go do what.

UM Thank you.

RS So uh

█ I think he's just, I think he knows he's, █, I think he knows that you know he should be taking his medicine and I think he's come to a

RS Mm hmm.

█ A (inaudible) here that you know he needs, he knows he needs to get help but he doesn't want to.

RS Right.

█ And uh apparently I guess he came up here I don't know I guess he got in a fight with his mom and them.

RS Yeah I don't, I don't really know all the details, so I'll talk with her.

█ Yeah you know like I said I went to the store then █ says well you ready for this, that's my other boy, what's that, █ up █ and █ and got a gun on a cop or something, I said what!

RS Now who's █ and █, whose house is he at?

█ That's █ right, that's her right there.

RS Okay.

█ █ apparently is over there at her house. I, I've never been over there.

RS Okay.

█ I don't know what the living situation is but, but I know █ use to live right down the hill.

RS Does he live there?

█ No, no he's got his own place, no electricity um up in her old house but, but █ use to live in this house right over here that my girlfriend lives in now, she lived with this guy just right there and I think that's when he got acquainted with █ and █, that was oh quite a few years back.

RS Okay.

█ Like probably in ninety seven (97) something like that.

RS I mean do, do you have any idea why he came up here today?

█ I don't know I guess to see █ and █ I don't know.

RS Okay.

■ I, I, like I say I haven't talked to ■

RS And from what I understand (inaudible). Obviously you don't agree with what he does.

■ No he doesn't come around when he's fucked up and he knows, cause I tell him you know. We got in a argument while back cause he needed, one of his water lines broke, (inaudible). And my other boy ■ was up his house after we had that cold weather remember?

RS Mm hmm.

■ And I said what are you doing and he said fixing ■ water, says well where's ■ at, he's in the house asleep, I said what, that don't (inaudible) right there you know.

RS Right.

■ So anyway a while after that ■ was over my house and uh came in said something about you know needed help fixing his water, I said well why can't you fix it ■, just needs a you know you need a pipe wrench or something or, only time you ever want to help dad is when you want me around is when you want me to help you, cause he'd babysat once in while,

RS Mm hmm.

■ When you know we'd go out or something, it's like we always pay him you know and he's sitting in a nice house, watching a big screen T.V. watching his little brothers you know that are you know nine (9) and eleven (11) now, I said you know what ■ fucking help yourself, you know what's wrong with you I says, you got two (2) good arms, you know you're an able bodied man, you know he got mad at me, you know cause I, I tell him how it is you know.

RS ■ has, has, has he been violent towards you or other people when he gets like this?

■ He never, never gets violent with me, he never has. Towards his mother and stuff I think so.

RS Yeah.

■ You know them but he doesn't, he doesn't go there with me.

RS Okay.

■ You know he just don't come around you know.

RS When he's doing something like this he stays away from you?

█ Yeah he don't come around me I mean cause he you know, just like my other boy was messed up for a while you know in to this north side, south side I says you know what █, I says don't come around here, don't come around my house, don't come around my other kids, you want to be in that gang shit I said you go ahead, but you keep it away from us.

RS Right.

█ I says you know if that's the kind of life you want to live, I mean that's kind of you know how I am with kids you know it's like. In her words, I'm so black and white. (Inaudible).

RS (Inaudible) pretty, I see what your saying that's black and white there, stay away for it.

█ Yeah I mean I don't want no part of it you know.

RS Well █ is there anything else I haven't asked you that would be important for me to know>

█ I don't know I mean.

RS I mean have you been seeing a decline, I mean you haven't been really around them much but have you been seeing a decline in his mental help at all?

█ I seen his, his, █ you know and, and, I've seen it and I've seen him messed up before and then █ he was big and healthy and, and uh he was pretty much a normal person,

RS Okay

█ You know lately █ and, and I think that, that you know is the reason why he's doing what he's doing is because you know he's probably not (inaudible), he's probably not eating █

RS No.

█ You know and stuff like I mean he needs you know he's not like a dangerous bank robbing, murdering criminal he's just you know he just, he needs help you know.

RS Right.

█ But I fear the worst right now you know.

RS Alright █ we'll end the interview at eighteen fifty five (1855).

█ HI mean he's got a good heart I mean he's got a lot of good in him.

End of transcript.

Transcribed on 12/14/07 by [REDACTED] 0608.

HUMBOLDT COUNTY SHERIFF'S DEPARTMENT

CASE: 200703162
INTERVIEWER: Rich Schlesiger, Detective
SUBJECT: Attempt PC 187/ Officer Involved Shooting
STATEMENT OF: [REDACTED]
DATE & TIME: June 3, 2007
LOCATION: Hoopa, California

ALSO PRESENT:

RS Rich Schlesiger
[REDACTED]

RS The date here, June third (3rd) two thousand seven (June 3rd, 2007). [REDACTED] is that your full name?

[REDACTED] It's [REDACTED]

RS How do you spell it?

[REDACTED] [REDACTED] last name [REDACTED]

RS And your middle name [REDACTED]

[REDACTED] [REDACTED]

RS And your date of birth [REDACTED]

[REDACTED] [REDACTED]

RS And where you live at [REDACTED]

[REDACTED] Hoopa.

RS What road?

█ [REDACTED], it's down by T triple C.

RS You got a phone number?

█ [REDACTED]

RS What, I really don't know exactly █ what's going on, I just pretty much just got here so can you fill me in on how, what led up to all this going on?

█ Yeah you know I, I don't know if you want to go back any about █ and his life, and where this started but,

RS We will, we will.

█ Okay so this (inaudible).

RS And your mom right?

█ I'm mom.

RS Okay.

█ Um about maybe a couple weeks ago, you know two months ago, █
and I took him █
█
█

RS Okay.

█ And you know I talk to Willie Hostler a couple weeks ago, I even wrote a letter and everything and I said listen you know █ is getting back into you know a bad situation um a year and a half ago, it will be two (2) years this August I believe it was, █
█
█

RS Okay.

█ it goes, █
Willie █
█
█

█ I said are you going to pay your bills, I'm going to go get food. █

█ I you know kept talking to Willie I said █

█ he starts you know sometimes you know he'll even take a college class and I had him before that, I took him out of the trailer park he was living in the trailer park █

RS Which trailer park?

█ The Trinity River Trailer Park, he had a trailer in there. I brought him to my house you know and he was there for quite a while and he was eating good and everything and then all of a sudden █

█ Willie █

█ Willie, █

█ he showed up and I, I was telling █ the story, I said gee █ last Friday night █

█ I said go ahead and cook, you can sleep here or whatever you know you want to eat. Well come to find █

█, he couldn't sleep, my stepson lives in the upstairs room, he's too old to be there anyway, he's twenty seven (27) he's loud, he talks all night on the phone, he's very loud, and um █ just kind █, he goes all I want is some sleep. And he got loud and obnoxious it just got worse, escalated and so at that point █ you know it should be enough for them to come, they did Eddie Guyer came, the ambulance, they came in together. █ was standing out there and he goes, he was fine, he was like this just like I found him yesterday and today incoherent and not responsive but you know he, he just said I just, could you just take me you know out of here and this and that cause then I'm the bad guy at that point you know he's mad at me. So they put him in the ambulance and they took him █

RS When was this?

█ Last Saturday morning at four thirty (4:30) a.m.

RS Okay.

█ Okay well █ and █

█ as any situation could happen right, well I guess he broke something there, it's a Crisis Center you know they hadn't got █ yet so they instantly called Sergeant Armstrong, I talked to him a couple times since then and they could, he couldn't figure out why he was called, he even told me he said I even wrote in there, I, you know I'm picking this guy up from █ they

brought him to the jail [REDACTED], from Saturday morning till Tuesday. I'm calling Sergeant Armstrong said he's help me, he did, I called the jail I said could you please get a Doctor [REDACTED], it took me that many days, [REDACTED] to the hospital. They got him in there and um Friday rolls around and they released him just like that. They didn't,

RS This last Friday?

[REDACTED] This last, just two (2) days ago. They release him, but the time I found him, he, the guy that took off walking he couldn't handle it that's his best friend and his first cousin, he um had been, [REDACTED] says the guy that was in the car, he said you know what it's almost [REDACTED].

RS What's [REDACTED] last name?

[REDACTED] um,

RS [REDACTED]

[REDACTED] No, no, [REDACTED].

RS Okay.

[REDACTED] [REDACTED]. And I noticed that too. I went over there last night to talk to him, he was sitting there just [REDACTED] I said [REDACTED],

RS Went over where?

[REDACTED] To his trailer. I moved his trailer over to [REDACTED] where he use to live, he wanted it over there really bad so he, he doesn't even have electricity over there we're trying to get the electricity,

RS What's the trailer look like?

[REDACTED] It's okay, it's a [REDACTED] singlewide trailer, pretty decent. He's got a couple chairs in there, a T.V., a bed in the back I mean,

RS Does he have any vehicles or anything?

[REDACTED] No. Um so he's [REDACTED] so then my other son [REDACTED] came tried to talk some sense into him, he goes come on [REDACTED] it's gonna be dark, you don't have any electricity here, took us like an hour to talk to him, coaxing him, he put on all his clothes. Um I'm kind of, I've taken I have a um a degree in addiction studies and all that so I kind of see when someone's in their [REDACTED], he's putting on all these clothes and it's hot you know he's got several shirts

on three (3) coats, a hat, I said [REDACTED], you can get heat exhaustion you know take that stuff off, and he's like no someone will steal it, in that tone.

RS Mm hmm.

JA So at that point I just reasoned with him and I got him a thing of water and filled it up, took him over to [REDACTED] said [REDACTED] can you watch him tonight I said until I can get him,

RS Who is [REDACTED]

JA My second (2nd) son.

RS Okay.

JA They're not even a year apart they grew up very close. [REDACTED] brings him to my house and I guess during the night [REDACTED] had just sat there and cut up stuff, [REDACTED] clothes this and that and he, [REDACTED] said, brings him home, Mom [REDACTED]. So he's there and,

RS What day was that on, you took him to [REDACTED]

JA Last night.

RS Last night.

JA Yeah and so that was last night; [REDACTED] said he'd watch him.

RS Where does [REDACTED] live at?

JA Over cross from the hospital on Tish Tang.

RS Okay.

JA Okay so then,

RS Same last name?

JA [REDACTED] yeah, [REDACTED] the dad okay.

RS Okay.

JA And um so he brings him to my house at ten (10) this morning, he starts getting all obnoxious all just like that and in a hot second he said hi mom I love you and the next second he was like where's my money, in a whole other tone, [REDACTED] totally a different person. I said [REDACTED] I don't, I can't have you around the baby, I'm raising my granddaughter she's three

(3), and she started crying, I took her in the bedroom I said [REDACTED] my husband can you please watch her in here. He comes out and he's going to spit on me,

RS Mm hmm.

[REDACTED] You know and I said come on [REDACTED] you know don't do that, so [REDACTED] took him out and dropped him off somewhere, and I, in the meantime I call um dispatch, I said could, [REDACTED] [REDACTED], he's just not acting himself I said he's, he shouldn't have [REDACTED], [REDACTED], I said you can tell [REDACTED], and so Mike came to the house, Mike Roberts and he tried looking for him,

RS Mike who?

[REDACTED] Mike Roberts.

RS The cop?

[REDACTED] Yeah

RS Okay.

[REDACTED] And um, he couldn't find him in the meantime, he gets a call, only police officer on duty here, he gets a call, has to go out town, meantime then [REDACTED] he makes it up here somehow [REDACTED]

RS And this is today then?

[REDACTED] Today, this is all in one (1) day, from this morning when I said I called and he came to the house, this is today.

RS Okay.

[REDACTED] So around noon, [REDACTED] called me she said listen, [REDACTED] came in, I didn't recognize him, he's got all these coats on,

RS [REDACTED] who?

[REDACTED] [REDACTED]

RS And is that the house [REDACTED] in now?

[REDACTED] Yes. He was fine, she was trying to get his clothes off cause he was over heated, he walked or something all the way up here.

RS Okay.

■ Um she tried to give him some water, he said I'm just tired, I just want to sleep and she called me she said ■ she was whispering in the back room, she didn't want him to think you know she was doing anything against, you know hurting him because I use to live up here and in old, ■ you know Willie the Chief,

RS Mm hmm.

■ That's his uncle,

RS Okay.

■ ■ use to haul hay for him and stuff and so uh ■ stepson, so ■ probably felt it was a safe place to go, someone that would talk to him and he said I just want to go to sleep.

RS This, this house here?

■ Yes.

RS Okay.

■ It was a safe place for him.

RS Who, when you got here who else was here besides ■

■ I didn't ever come up here.

RS Oh you didn't.

■ No I called dispatch and I said can you send, cause ■ said you know ■ is not ■

RS Oh, ■ called you?

JA Yes. She said ■ up here, that's how I knew he was up there. I said you know I tried to call the ambulance earlier and stuff and they were looking for him and then there was no officer's on duty, she said you know what ■ she said it's kind of you know ■ he's not answering much, he won't say anything, he's not responding. They were gonna take him down the hill and then I kept calling that dispatcher, ■ who didn't know much and he said listen I'll send someone up there, that's when I said you got to be really careful, I said send an ambulance with him, this ambulance driver knows him, he brought him out Saturday morning at four thirty (4:30) in the morning, so um he gets to these two (2) white gates here cause ■ was standing down here and she has a cell phone and she's calling me point

by point, telling me, they're not here yet, they're not here yet, so Officer Berry from the Yurok Tribe gets to those two (2) white things and she's standing down there and she's talking to me as he pulls up, and she said here, talk to his mom, so I called, I talked to him and I said this is the situation, [REDACTED], [REDACTED] and I said I called Mike Roberts, he knows about it, he was going to deal with it but he had a call out town and so he said okay, I'll wait you know till Mike Roberts gets back and we'll bring a um ambulance up there and we'll deal with it that way, I'd rather do that. [REDACTED] calls me not minutes after that crying and [REDACTED] was up at the house with [REDACTED] and she said [REDACTED] he,

RS [REDACTED]

[REDACTED] that's [REDACTED] like husband, they've been together for like twenty (20) years or more.

RS Okay. Are they around here?

[REDACTED] They were told to leave. [REDACTED] is the one (1) that you seen come walk down here, [REDACTED]

RS Okay.

[REDACTED] She, she went up in the brush and has been hiding up there and then got her truck out of there some how, must have been parked up somewhere, so she said he went flying in there, with a siren and the loud speaker and it scared [REDACTED] just like that you don't do that with someone [REDACTED], he went flying in there, totally lied to me, told me lied to me, told me he was gonna wait for Mike and,

RS Well what did, what did uh [REDACTED] tell you was, what was, what was [REDACTED] crying about?

JA Because he did that because she just heard him say she was going to wait, he was going to wait for the ambulance and Mike, and he didn't, soon as he got off the phone, he went flying in there, he didn't do anything that he said, I said well you got to be careful, he gets scared, and he said okay, I'll wait for the ambulance and this and that, he didn't, he went flying in there with the sirens, went up to the house with a loud speaker, [REDACTED] come running out cause he was sitting there talking to [REDACTED] trying to you know and he come running out, the guy tells [REDACTED] to get behind his rig so [REDACTED] didn't even you know, get to say anything, hollering and this and that it scared [REDACTED], it scared [REDACTED], he didn't have a gun on him when he went up there, there was obviously a gun in the house and that's when he just pointed it, well it scared him you know, he's seeing the situation and then this escalated to this, that's how it happened, it should've never been like that. Just Saturday morning when they came to my house, an officer and an ambulance, he got in, it was fine, that guy should, I mean and I just through telling him [REDACTED] [REDACTED] and he was just [REDACTED] Friday, he's shouldn't have been, he's kind of not stable you know and I don't know why it had to escalate like this, it's.

RS What, when you, when did you eventually get up here [REDACTED]

[REDACTED] Because [REDACTED] was calling me, I was afraid to come up here you know I kept saying, are they going to let me talk to my son, cause [REDACTED] said when it was just that one (1) officer, she could hear him saying [REDACTED], help me. If they would have let [REDACTED] talk to him, he would have been out by now, he was calm then, he goes please [REDACTED] help me, she was calling me on the phone, she goes [REDACTED] and she was telling me he's hollering at me right now, they won't even, she was hiding in the brush, they, that officer made her go up and hide in the brush with her little boy. So I just stood down on my porch calling, she was calling back and forth, back and forth cause I didn't expect it to be like this and I was afraid to come up here you know and, and see this and then finally she calls me, she goes there is S.W.A.T. Team, there's guns, there all standing out there pointing at the house and it's scary, I know he's scared to death. She said it's gotten worse and worse, you need to get up here and so I came flying up here and my ex husband [REDACTED] heard from my son [REDACTED] at the store what was going on and so he came up here but,

RS What, so what exactly happened between uh [REDACTED] and [REDACTED] then?

UM Are your keys in your car?

[REDACTED] Yeah.

UM Can [REDACTED] move your, back your car up so we can get this thing in there, thanks.

RS What, what happened between [REDACTED] and [REDACTED] or [REDACTED] and [REDACTED] for all this, I mean what, what, what were they so worried about?

[REDACTED] They weren't, it happened this morning when [REDACTED] came to my house and Mike Roberts was suppose to get the ambulance and get him um out to [REDACTED] but Mike had to leave, so then,

RS So.

[REDACTED] So then [REDACTED] just called me and she said [REDACTED] what do I do with [REDACTED]

RS So did you go to work, what did you do, how did [REDACTED] ever leave your house?

[REDACTED] This morning [REDACTED] took him out um I said [REDACTED] I took [REDACTED] and [REDACTED] over to [REDACTED] house last night,

RS Okay.

[REDACTED] To see if [REDACTED] would you know come out of it, calm down or what but [REDACTED] fell, went to sleep, him and his um fiancé and he said when he woke up this morning [REDACTED] had you know

like cut up his clothes and this and that, hide his toothbrush and [REDACTED]

RS Mm hmm.

[REDACTED] Like I'm hiding it because someone's gonna

RS Right.

[REDACTED] You know it's this person [REDACTED] he brought him over back to my house and so [REDACTED] then, this morning early before ten (10), he came in and he just was irrational and I said [REDACTED] I said I, [REDACTED]

RS What, what do you mean by that, what do you mean by that [REDACTED]

[REDACTED] "F" ing bitch, give me my money.

RS So he really was

[REDACTED] Then spit at me,

RS So he really has an issue with getting his money then?

[REDACTED] Yes and I told him I said you know what [REDACTED] I said I'll buy your food, I'll pay your bills and everything but at this point [REDACTED], I don't want to give you money and you go [REDACTED]

RS Right.

[REDACTED] I said you know I love you too much for that and this is what's happened for the last two (2) months, you've demanded your money and I don't know [REDACTED] [REDACTED]. So I'm the one (1) that initially called to get help and all I wanted was an ambulance [REDACTED]. I didn't expect all this to happen.

RS Where, where did this gun come from?

[REDACTED] I, at [REDACTED] house, inside of their house.

RS So they, did they know, so the,

[REDACTED] I don't think they knew that all this was going to happen.

RS Did [REDACTED] know there was a gun there or something or?

[REDACTED] Unless it was just laying there or you know,

RS Okay.

[REDACTED] or something and he just seen it you know I, I don't know, I.

RS Does, does [REDACTED] have any other guns like at his house or anything like that?

[REDACTED] The only gun he had was a twenty two (22) and [REDACTED] took it like a week ago when he went in, [REDACTED] went over to his place and he said mom there was a gun there and he said I'm going to lock it up at someone else's house I wanted to get it out of there but [REDACTED] didn't have any on him.

RS Okay.

[REDACTED] You know.

RS What about, you, you mentioned [REDACTED] and [REDACTED], what, I mean how bad is it?

[REDACTED] I don't know, like I said he's been really straight to the point [REDACTED] he'll take a class you know he was,

RS You think when he

[REDACTED] Stops taking his,

RS [REDACTED]

[REDACTED] When he stops [REDACTED] there is vultures in Hoopa and they know [REDACTED] and they start trying to talk, [REDACTED], I'll, I mean even the guy up there, he told me he said I seen it [REDACTED] right before my eyes, he said oh come on [REDACTED] you know, [REDACTED] [REDACTED] so then they get their money [REDACTED] [REDACTED]

RS Okay.

[REDACTED] Because [REDACTED], he said for the longest time [REDACTED] would say no, no, I don't want to do that well then if you have a problem with it and someone's there waiving it at you all the time and I told Willie that um a couple of people I said oh yeah they were bound and determined gonna be [REDACTED] you know and

RS Mm hmm.

■ And I said I'm not gonna do that.

RS Well ■ explain to me a little bit more about why ■ ends up there though at ■

■ Well because when he was um probably thirteen (13) fourteen (14) fifteen (15) maybe I lived up around the corner, way up there

RS Okay.

■ And ■

RS Okay.

■ ■ uncle, he's a old, old guy, he lives up there and um ■ use to go up there and bail hay, help him stack hay, clean his yards, do all kinds of stuff and, and ■ my mentor you know and help me out in some hard days I had a long time ago, right after my divorce, that was clear back in ninety four (94) ninety five (95), you know and then his stepson is ■ so ■ were living there in the house down the road where ■ at

RS Okay.

■ And they kind of befriended ■ was,

RS So they all know each other, that, that's not something odd for,

■ Oh no ■

RS Okay.

■ That's why ■ thought it was a safe place. He'd you know when he was a boy he use to go and visit all the time and um he'd come up here every once in a while you know and you know they loved ■ they seen him grow up and stuff and that's why it just like breaks their heart to see all of this when they didn't want that. They just called, she just called to tell me God ■, he, ■,

RS Did ■ explain a little of how ■ was acting?

■ That's all, same way that he was this morning.

RS Kind of just,

█ you, I'd talk to him, I'd say █ and he'd go, I'd go █ look at me. What, what did you, he wouldn't even remember a second later what I was saying.

RS Did uh █

█ I think that's what caused the most part.

RS Okay, okay.

JA When he turned um eighteen (18) and he gets that stupid Hoopa money he um he just you know he, he kind of, that's what I think caused it. I think that everyone knew the vultures around here knew he got money and anybody and everybody █

RS Mm hmm

█ You know and he, I'm sure that he never ever wanted to,

RS (Inaudible) was telling me he was an athlete and stuff like that in school.

█ Yeah. He worked at Fishers where █ works, I was so proud of him, he was only a junior in High School, he worked there and saved up enough for his own Ranchero, really healthy young boy, worked I mean he did, he just was, he's got a big heart, you know he just loves everybody and even █ the guy that was with me and he couldn't handle this, he started crying and took off walking he goes gosh █ even when he does have money he's always um giving people money you know if they have kids, oh you got food money for dinner, he don't even have much money but he'll hand over whatever he has you know, go buy people diapers and this and that for their kids, so I just

RS So

█ I think that this is what I think, years ago, █ cause I'll never forget it, they took off some people from down Pecwan, he had a █ car at point, he took off I hadn't seen him for three (3) days, I was at the old house on Masten Flat where now he has his trailer pulled in there and someone come, I and I was asleep, I heard someone come flying in and leave, well they stole his car and they kicked him out and that's when he changed, and I think that █ or something because from then on █ everything started coming out, and I was asleep and my window was open a little bit, and I heard, it almost sounded like mom, I thought it was an animal and I was scared cause it's kind of back in the dark,

RS Mm hmm.

■ I finally went up and he was laying in a heap, in the road, beat up, I got him in the house, I cleaned him all up, got him some water, propped him up,

RS How old was he when this happened ■

■ Nineteen (19).

RS And he's how old now?

■ Twenty six (26). So from then on, I kept trying to get him help, I knew that he had um ■ from that and everyone even said, that summer, it was in the summer, something happened to ■, you know it was somebody ■, I swear that someone put something in it, ■, you know he's like, "hi mommy I love you" you know and this and that, he just a really sweet boy and so I just, ■ you know what I mean, ■ and I think that's maybe what's happened here ■, ■ now he's been, ■

RS Well that; I was going to ask you that, what, ■?

■ ■

RS What was the last one (1)?

■ ■

RS At night?

■ Yeah.

RS ■

■ ■, they gave it to him on Friday and I said why did you ■,

RS ■

■ No I didn't expect him out until Saturday, I went over to Butte County to my nephews graduation and so, I'm trying and plus ■ so I went into the hospital on Thursday,

RS So he was out Friday and [REDACTED]n,

[REDACTED] He, yeah, he went right to, he went to my house, I wasn't there, so he went to [REDACTED] house cause that's Masten Flat, you know there's a bunch of houses up there and he calls [REDACTED], his auntie, [REDACTED] grandma, he calls her gram, so he went there and he, and that was right after he got out [REDACTED] [REDACTED] made a comment gosh [REDACTED] [REDACTED] [REDACTED] he's like doing that, [REDACTED] and you're hey are you listening, you know and [REDACTED] and that was yesterday.

RS Okay.

[REDACTED] Or Friday he said, and that's why I said,

RS So probably [REDACTED] is the first person to see

[REDACTED] [REDACTED]

RS [REDACTED]

[REDACTED] [REDACTED]

RS The grandma?

JA Yeah because I called there on my way back and I was in Weaverville, and [REDACTED] said you need to come here and um get [REDACTED] she said he was, he was you know for some reason [REDACTED] he's just, he forgets a second later what he's doing, she said he just sits there [REDACTED] [REDACTED] at all. I said I'll be back that was yesterday, I said I'm in Weaverville I'm on my way home, I'll go right up there, that's when I said I went up there, went out to his trailer, he's sitting there [REDACTED] he wouldn't listen to me you know he went you know it's wasn't that he wouldn't listen to me, he wouldn't respond, didn't respond at all. It was scaring me, I said come on [REDACTED], I don't, I can't leave you here [REDACTED] and then [REDACTED] my boy came, cause he heard you know [REDACTED] wasn't doing very well, he came walking in and I go thank you for coming. I said [REDACTED] we need to get him out of here, can you talk to him, so he kept talking to him and talking to him and it took like an hour or more to get him up, out of there, he started putting all these clothes on and that's the story I said when I got over to [REDACTED], over to [REDACTED], [REDACTED] was going to watch him and all the rest happened.

RS Okay. Well before I mean, today it sounds like he was kind of on you a little.

JA This morning.

RS This morning?

■ Yeah.

RS And then what about before [REDACTED], how was he acting before then too, kind of the same way?

■ [REDACTED] angry.

RS How long has he been this angry, [REDACTED]

■ Well I haven't seen all of it, but my son [REDACTED], who works at [REDACTED] um he would be driving by, he was afraid to even pick him up and people would tell him he said, they said gosh [REDACTED]

RS Mm hmm.

■ This has been going on for a month. [REDACTED] and [REDACTED] would come home and tell me other people would tell me things, I said gosh you know [REDACTED], I said I know, I can't force him to go out there, I have [REDACTED] won't go unless [REDACTED], and so that's been like for the last month, [REDACTED].

RS What about, has he been violent towards you or anything like that?

■ Just his mouth, he gets loud and, and mouthy all of a sudden just like it's, it's almost you know strange because it will, it'll, he'll walk in, I love you mommy and give me a hug and everything and then,

RS Just turn around and,

■ Yeah, and you "f" ing bitch, I mean, totally I mean, it hurts my feelings [REDACTED]

RS But he, he's got a big thing about this money thing though right?

■ Yes.

RS Okay.

■ And he never use to, for the whole time that I've been his payee, it was fine with, I'd go pay his rent when he was in the trailer park, I'd pay his bills, we go out town, buy all his food, he'd get his little, new shoes or new pants, all of his deodorants you know, his special stuff, and then I'd give him some spending money on the weekends and he'd even have money left at the

end of the month and he only gets [REDACTED], but I had it spread out and I'd write on his little envelope you know what was spend on what. He was cool with that and all of a sudden two (2) months ago and he started and it was because of these friends, and I heard it, [REDACTED] even told me too, one of them is [REDACTED], she came up to [REDACTED] I'm gonna be his payee, your mother steals all his money, and he goes mom don't steal all his money, he pays his bills and stuff and she's one (1) [REDACTED].

RS Okay.

[REDACTED] So.

RS [REDACTED] do you know [REDACTED] phone number?

[REDACTED] I think it's [REDACTED] I'm pretty sure it's [REDACTED] [REDACTED]

RS [REDACTED]

[REDACTED] [REDACTED]

RS Okay and what about [REDACTED]

[REDACTED] [REDACTED] don't have a phone.

RS Okay where does he live at?

[REDACTED] He lives over on Tish Tang, um it's uh driveway, the last driveway, there's like a gravel pit and stuff, [REDACTED] before the dental clinic and K'ima W Medical Center, it's on the right.

RS Before the turn off to go down there or?

[REDACTED] No you go down there towards the hospital.

RS So on Airport Road down there?

[REDACTED] Yeah on Airport Road, it's um the first right turn before the dental clinic and K'ima W Medical Center is right on the other side. [REDACTED]

RS Does [REDACTED] got a phone number?

[REDACTED] My house, he lives with me.

RS Okay,

■ Um,

RS ■

■ Yeah.

RS Okay. Okay ■ is there anything that I haven't asked you, you think would be important for me to know?

■ I don't know I just don't want anything bad to happen to my son and you know and he does have a big heart, he just needs ■ and I didn't want any of this to happen, all I wanted was the ambulance to go and get him.

RS Okay. We'll end the interview at nineteen forty three (1943).

End of transcript.

Transcribed by ■ 0608 on 12/26/07.

HUMBOLDT COUNTY SHERIFF'S DEPARTMENT

CASE: 200703162
INTERVIEWER: Rich Schlesiger, Detective
SUBJECT:
STATEMENT OF: [REDACTED]
DATE & TIME: June 3, 2007 @ 2024 hours.
LOCATION: Hoopa, California

ALSO PRESENT:

RS Rich Schlesiger
[REDACTED]

[REDACTED] Is that cordless?

RS Yeah. Lets see the date is June third, two thousand seven (3rd, 2007), time is twenty twenty four (2024) hours. Is it Gordon?

[REDACTED] Yeah.

RS [REDACTED] what's your middle name?

[REDACTED] [REDACTED], it's like [REDACTED]

RS [REDACTED]

[REDACTED] Yeah.

RS What's your date of birth [REDACTED]

[REDACTED] [REDACTED]

RS Where do you live at?

[REDACTED] [REDACTED]

RS With mom?

■ Yeah.

RS Okay. What's the phone number there?

■ [REDACTED]

RS [REDACTED]

■ Mm hmm.

RS Do you have a P.O. Box?

■ [REDACTED]

RS Okay. [REDACTED] what I'm trying to figure out is, why we're in the situation we're in with [REDACTED], um your, your mom mentioned something to me, that you, you saw him not to, pretty recently?

■ Yeah

RS When did you last see [REDACTED]

■ I think it was this morning.

RS This morning, what time about?

■ About ten (10) or eleven (11).

RS Okay.

■ Maybe earlier,

RS Was it at the house?

■ He kind of woke me yeah.

RS Okay, who else was there?

■ Um I don't know I was sleeping and he woke me up and you want uh, you want to know like what was between us or?

RS How did you wake up yeah, how did you?

■ Yeah cause I you know when somebody is present in your room or something,

RS Mm hmm.

■ And that kind of changes the air?

RS Mm hmm.

■ That, that's what happened, I woke up and I looked up at him, and I didn't know who it was at first, and then I kind of realized who it was and I said oh hey ■ and I was going to get up and give him a hug cause I didn't see him for (inaudible) missed him and I just kind of stayed in bed and he said he came in and he was looking for his guitar and it wasn't on the right side where he left it, it was on the left side of my closet cause I cleaned it.

RS Mm hmm.

■ And I was like oh it's on that side, he's all it's okay, I'll just give it to (inaudible) that's my daughters name and I was like I didn't say nothing you know I was going to say well it's your stuff (inaudible) take your stuff you know

RS Mm hmm mm hmm.

■ But I just kind of let him, let him say what he was going to say and then, then I kind of went back to sleep and he disappeared and then that was it and I woke up at twelve (12).

RS How, how would you say ■ was acting?

■ Well in between that amount of time I mean you couldn't really determine how he was acting or I mean he seemed fine because I was just waking up and

RS Did you hear him yelling at mom or anything like that?

■ No I, I was sleeping before that.

RS Okay.

■ But he does that a lot, it's mainly over his money.

RS Over his money?

■ Cause he wants to go party with it or do whatever and needs t take care of his bills and stuff.

RS Right and mom's his payee?

■ Yeah.

RS And you understand that [REDACTED]

■ Yeah.

RS Yeah [REDACTED]?

■ Yeah.

RS Yeah, what do you know about that?

■ He just likes to be, himself it doesn't bother him, [REDACTED] but all this other stuff comes along with it.

RS Right, right.

■ Like his physical well being or whatever you call it, you know he doesn't see that this is what it's doing to him, he just thinks of being high and liking it.

RS Mm hmm. How long have you know [REDACTED] to be using [REDACTED]

■ Well he's actually been really clean and he's just got back on it recently.

RS How long ago would you say?

■ Um [REDACTED] it was about six (6), about eight (8) months to a year ago, [REDACTED].

RS Okay. Uh why, I mean why are we in the situation we're in right now with him being armed here and all that, what, what's the story?

UM Can I borrow you for a minute?

RS Yeah.

(Inaudible).

■ I'm thinking it's because something that escalated from something else and

RS What, what do you mean by that?

■ He was, he isn't, [REDACTED] any little thing can escalate into a big thing, we could be talking about something small and,

RS He just flies off the end sometimes?

■ Yeah and I'm not blaming it on him, it's just in between two (2) people, one (1) thing happened and you know we're only people I mean we can't control everything about ourselves.

RS Right. This, [REDACTED]

■ [REDACTED].

RS Is it more [REDACTED] or?

■ Um I remember one (1) time he was up in my bedroom and he was tapping a twelve-gauge bullet on the thing saying he was going, waiting for it to shot himself in the face with it.

RS How long ago was that?

■ This was years ago.

RS Okay. So a while ago, he was like that but it's changed a little bit?

■ Yeah.

RS Okay. So how would you say he is more now, [REDACTED], more I mean what would you say?

■ It's on a free range basis pretty much he just does what ever.

RS So he's just up, up down, all over.

■ He just doesn't think no more, I mean I wouldn't say he's [REDACTED] it's just anything can happen at any time with him.

RS Okay. Okay.

■ So it's like,

RS Why would he come up here to [REDACTED]

■ Well he was friends with them when he's sober he's friends with them because, when he's sober he's friend's with a lot of people [REDACTED], still be's his friend but they don't want to have something like this happen.

RS Right, right I see what your saying. Um I mean did uh, what I'm trying to understand, I mean is he paranoid about something or, or does he just get pissed off?

█ Get's pissed off.

RS Okay has he ever been violent towards you or you ever seen him violent towards anyone?

█ Uh. Can't say me and him ever got in a fight.

RS Okay.

█ I mean that's why I'm up here cause me and him, he considers me as his best brother because well that's what he tells, I don't know if he tells us all that but, because I sit, █ I'll still let him sleep in my bed or everyone else they can't stand him when he's like that.

RS Have you ever talked to him █?

█ Well I'm not really a perfect person so like if I did, he would like kind of

RS Put it back on you too?

█ Yeah put it back on me so I never really did that. I told him you know what it does do (inaudible).

RS Did you; █?

█ Oh no and I wasn't around him today, I've been at work, I just got off work. I took off work.

RS You work at Rays?

█ Yeah I took off the rest of the day so and come up here and at least see him but they said I can't even talk to him or try and talk to him out of it or nothing.

RS Why do you think he would shoot at the cops?

█ I don't even know if he thinks he's doing right, he's probably just scared.

RS Okay. Have you seen him scared before like that?

█ Yeah.

RS And,

■ [REDACTED] when he's scared.

RS Okay.

■ He pretty much just curls up in a ball but he, you know but everything else of him does that.

RS Okay I see what you're saying. So almost like two (2) different people then?

■ Yeah kind of like (inaudible) he just kind of kind of just goes off kind of and, he thinks he's avoiding the matter.

RS Okay. Have you ever seen him with any guns, you mentioned that, that shotgun shell you ever seen him with any guns?

■ Um use to own shotgun before it got stolen.

RS How long ago was that?

■ This is last year, I believe.

RS He lives down on Masten Flat?

■ Yeah. Well it wasn't his, cause he ain't allowed to carry guns but it was his hunting rifle.

RS Okay.

■ It was his hunting for like quail and stuff.

RS How about this [REDACTED] guy he hangs out with?

■ It's our cousin.

RS What can you tell me about him?

■ That's his friend, they go have fun together.

RS They party together?

■ [REDACTED] ain't really a partier I mean he might do things, but he don't party, he's like, he's kind of a quiet guy, he stays away from crowds cause he's kind self conscious or something that's what I get out of him.

RS Okay.

■ I don't really know him that much. He's my cousin but I never really hung around him, he use to watch me when I was a baby but.

RS Okay. Okay ■ is there anything that I haven't asked you, you think would be important for me to know, that you can think of?

■ Not really just, I don't know.

RS Okay.

■ I'm just kind of worried about him right now.

RS I understand. Okay we'll end the interview at twenty thirty four (2034).

End of transcript.

Transcribed on 12/26/07 by ■ 0608.

HUMBOLDT COUNTY SHERIFF'S DEPARTMENT

CASE: 200703162
INTERVIEWER: Rich Schlesiger, Detective
SUBJECT:
STATEMENT OF: [REDACTED]
DATE & TIME: June 3, 2007 @ 2024 hours.
LOCATION: Hoopa, California

ALSO PRESENT:

RS Rich Schlesiger
[REDACTED]

[REDACTED] Is that cordless?

RS Yeah. Lets see the date is June third, two thousand seven (3rd, 2007), time is twenty twenty four (2024) hours. Is it [REDACTED]

[REDACTED] Yeah.

RS [REDACTED] what's your middle name?

[REDACTED] [REDACTED]

RS [REDACTED]

[REDACTED] Yeah.

RS What's your date of birth [REDACTED]

[REDACTED] [REDACTED]

RS Where do you live at?

[REDACTED] [REDACTED]

RS With mom?

■ Yeah.

RS Okay. What's the phone number there?

■ [REDACTED]

RS [REDACTED]

■ Mm hmm.

RS Do you have a P.O. Box?

■ [REDACTED]

RS Okay. [REDACTED] what I'm trying to figure out is, why we're in the situation we're in with [REDACTED] um your, your mom mentioned something to me, that you, you saw him not to, pretty recently?

■ Yeah

RS When did you last see [REDACTED]

■ I think it was this morning.

RS This morning, what time about?

■ About ten (10) or eleven (11).

RS Okay.

■ Maybe earlier,

RS Was it at the house?

■ He kind of woke me yeah.

RS Okay, who else was there?

■ Um I don't know I was sleeping and he woke me up and you want uh, you want to know like what was between us or?

RS How did you wake up yeah, how did you?

■ Yeah cause I you know when somebody is present in your room or something,

RS Mm hmm.

■ And that kind of changes the air?

RS Mm hmm.

■ That, that's what happened, I woke up and I looked up at him, and I didn't know who it was at first, and then I kind of realized who it was and I said oh hey ■ and I was going to get up and give him a hug cause I didn't see him for (inaudible) missed him and I just kind of stayed in bed and he said he came in and he was looking for his guitar and it wasn't on the right side where he left it, it was on the left side of my closet cause I cleaned it.

RS Mm hmm.

■ And I was like oh it's on that side, he's all it's okay, I'll just give it to (inaudible) that's my daughters name and I was like I didn't say nothing you know I was going to say well it's your stuff (inaudible) take your stuff you know

RS Mm hmm mm hmm.

■ But I just kind of let him, let him say what he was going to say and then, then I kind of went back to sleep and he disappeared and then that was it and I woke up at twelve (12).

RS How, how would you say ■ was acting?

■ Well in between that amount of time I mean you couldn't really determine how he was acting or I mean he seemed fine because I was just waking up and

RS Did you hear him yelling at mom or anything like that?

■ No I, I was sleeping before that.

RS Okay.

■ But he does that a lot, it's mainly over his money.

RS Over his money?

■ Cause he wants to go party with it or do whatever and needs t take care of his bills and stuff.

RS Right and mom's his payee?

■ Yeah.

RS And you understand that ■ ■

■ Yeah.

RS Yeah ■

■ Yeah.

RS Yeah, what do you know about that?

■ He just likes to be, himself it doesn't bother him, he just gets high but all this other stuff comes along with it.

RS Right, right.

■ Like his physical well being or whatever you call it, you know he doesn't see that this is what it's doing to him, he just thinks of being high and liking it.

RS Mm hmm. How long have you know ■ ■

■ Well he's actually been really clean and he's just got back on it recently.

RS How long ago would you say?

■ ■

RS Okay. Uh why, I mean why are we in the situation we're in right now with him being armed here and all that, what, what's the story?

UM Can I borrow you for a minute?

RS Yeah.

(Inaudible).

■ I'm thinking it's because something that escalated from something else and

RS What, what do you mean by that?

■ He was, he isn't, his mentality and how he is, any little thing can escalate into a big thing, we could be talking about something small and,

RS He just flies off the end sometimes?

■ Yeah and I'm not blaming it on him, it's just in between two (2) people, one (1) thing happened and you know we're only people I mean we can't control everything about ourselves.

RS Right. This, have you ever heard him talk about suicide or anything like that or?

■ [REDACTED]

RS Is it more paranoia now or?

■ Um I remember one (1) time he was up in my bedroom and he was tapping a twelve-gauge bullet on the thing saying he was going, waiting for it to shot himself in the face with it.

RS How long ago was that?

■ This was years ago.

RS Okay. So a while ago, he was like that but it's changed a little bit?

■ Yeah.

RS Okay. So how would you say he is more now, more paranoid, more I mean what would you say?

■ It's on a free range basis pretty much he just does what ever.

RS So he's just up, up down, all over.

■ He just doesn't think no more, I mean I wouldn't say he's paranoid or suicidal it's just anything can happen at any time with him.

RS Okay. Okay.

■ So it's like,

RS Why would he come up here to [REDACTED] place?

■ Well he was friends with them when he's sober he's friends with them because, when he's sober he's friend's with a lot of people but when he gets high everyone, still be's his friend but they don't want to have something like this happen.

RS Right, right I see what your saying. Um I mean did uh, what I'm trying to understand, I mean is he paranoid about something or, or does he just get pissed off?

■ Get's pissed off.

RS Okay has he ever been violent towards you or you ever seen him violent towards anyone?

■ Uh. Can't say me and him ever got in a fight.

RS Okay.

■ I mean that's why I'm up here cause me and him, he considers me as his best brother because well that's what he tells, I don't know if he tells us all that but, because I sit, even when he's high, I'll still let him sleep in my bed or everyone else they can't stand him when he's like that.

RS Have you ever talked to him [REDACTED]

■ Well I'm not really a perfect person so like if I did, he would like kind of

RS Put it back on you too?

■ Yeah put it back on me so I never really did that. I told him you know what it does do (inaudible).

RS Did you; did you see him [REDACTED]

■ Oh no and I wasn't around him today, I've been at work, I just got off work. I took off work.

RS You work at [REDACTED]

■ Yeah I took off the rest of the day so and come up here and at least see him but they said I can't even talk to him or try and talk to him out of it or nothing.

RS Why do you think he would shoot at the cops?

■ I don't even know if he thinks he's doing right, he's probably just scared.

RS Okay. Have you seen him scared before like that?

■ Yeah.

RS And,

■ He just does crazy things when he's scared.

RS Okay.

■ He pretty much just curls up in a ball but he, you know but everything else of him does that.

RS Okay I see what you're saying. So almost like two (2) different people then?

■ Yeah kind of like (inaudible) he just kind of kind of just goes off kind of and, he thinks he's avoiding the matter.

RS Okay. Have you ever seen him with any guns, you mentioned that, that shotgun shell you ever seen him with any guns?

■ Um use to own shotgun before it got stolen.

RS How long ago was that?

■ This is last year, I believe.

RS He lives down on Masten Flat?

■ Yeah. Well it wasn't his, cause he ain't allowed to carry guns but it was his hunting rifle.

RS Okay.

■ It was his hunting for like quail and stuff.

RS How about this ■ guy he hangs out with?

■ It's our cousin.

RS What can you tell me about him?

GS That's his friend, they go have fun together.

RS They party together?

■ ■ ain't really a partier I mean he might do things, but he don't party, he's like, he's kind of a quiet guy, he stays away from crowds cause he's kind self conscious or something that's what I get out of him.

RS Okay.

■ I don't really know him that much. He's my cousin but I never really hung around him, he use to watch me when I was a baby but.

RS Okay. Okay ■ is there anything that I haven't asked you, you think would be important for me to know, that you can think of?

■ Not really just, I don't know.

RS Okay.

■ I'm just kind of worried about him right now.

RS I understand. Okay we'll end the interview at twenty thirty four (2034).

End of transcript.

Transcribed on 12/26/07 by ■ 0608.

HUMBOLDT COUNTY SHERIFF'S DEPARTMENT

CASE: 200703162
INTERVIEWER: Rich Schlesiger, Detective
SUBJECT: Attempt PC 187/ Officer Involved Shooting
STATEMENT OF: [REDACTED] #2.
DATE & TIME: June 4th, 2007 @ 0700
LOCATION:

ALSO PRESENT:

RS Rich Schlesiger

[REDACTED]

RS [REDACTED] what was your full name again?

[REDACTED]

RS Spell [REDACTED] for me.

[REDACTED]

RS Your date of birth again?

[REDACTED]

RS Okay. [REDACTED] back down at the house yesterday morning,

[REDACTED]

Mm hmm.

RS Was there something, did that, did, did uh did um, did he threaten you at all?

[REDACTED] All he did is he, he came, [REDACTED] brought him in because like I said he was at [REDACTED] all night and then when [REDACTED] woke up he had you know cut up his stuff and he was, in his mind he was protecting it and then when he got there,

RS Did he kind of tear up [REDACTED] house?

JA No not like that, what [REDACTED] does is, he'll say stuff like I cut it up to protect you, there's evil stuff in it or something you know.

RS Mm hmm.

JA It, it's like he's protecting him and so he hid his toothbrushes because something was on his toothbrushes and that's what [REDACTED] was reiterating to me is that it was almost like yeah he ripped up his stuff, cut it up and stuff but it was more like he's, there's evil stuff or things that are going to harm my brother so I'm gonna protect him.

RS So [REDACTED] was kind of like you need to deal with him then?

JA Yeah because he's like oh mom me and my fiancé got in a big argument cause he cut up you know some of her stuff too and she's like geez you know we can't handle this um

RS What kind of stuff did, did he cut up?

JA Like um a couple pieces of his clothing and one (1) main thing is um he, what is those, the fish, the gears um,

RS Oh okay.

JA Those you know,

RS Waders.

JA Ski Doo gears, no it's a whole

RS Oh a whole suit.

JA No it's a whole suit, wet suit.

RS And he's wearing that?

JA No he didn't wear it, he cut it up, very expensive, one (1) of [REDACTED] you know prize things.

RS Okay.

JA That he wears Eeling and then the river and stuff and I don't think that was it, he found that and it was like man that's expensive, cut up my other stuff so he said, get in, so he got in and he took him over my house and instantly cause I'm his payee too you know he, he's like um give

me my money and his whole tone is different, it's not, well at first he said, he said hi um "hi mom I love you," just like he did the day before.

RS Mm hmm.

■ Hi mom I love you and then he was trying to get money out me the day before and I go no ■ you if you want any food or your bills paid I'll go do it you know.

RS Okay.

■ And he had an uh amp and guitar in hook at I think some drug house and I said you know ■ I'll go get that for you, you know give them the forty (40) bucks whatever, I'll go and give him the money myself, I'm not giving you no cash. And um so then he was like, after you know he went from night to day just like and he goes, I want some money his whole like this, his chin was all, just you know, didn't look like him and I knew then because I've seen him in that state before, he just you know he gets. He would never hit me I mean he's never hit any of us, but he, he just gets so his mouth and everything he gets,

RS Yeah.

■ Really, really loud and belligerent and cussing and he just, he said you "f" ing bitch. Give me my money and then he started to hock up and ■ was standing there and he goes "hey" and he was going to spit on me.

RS Did he, do you have a younger daughter or son?

■ ■ is my youngest and I have his daughter, custody, she's in my custody cause he was a teen dad.

RS What, what did he, what did ■ mention about her at the house?

■ He didn't mention anything.

RS Did he mention something about hurting her?

■ Uh uh, no. She um, she just heard the hollering and took off and I grabbed her um and took her back to the room to ■ my husband.

RS Okay.

■ But she just started crying because of the loud everything you know.

RS And how old is she?

■ Three (3).

RS What's her name?

■ [REDACTED]

RS What's the last name?

■ [REDACTED]

RS [REDACTED] okay. How do you spell that?

■ [REDACTED]

RS Yeah.

■ [REDACTED]

RS Okay.

■ No he loves her very much.

RS Okay.

■ He just, you could tell that blank, that dark eyes, the blank look he's you know no looking at me like mom no more and he's been in and out like that.

RS Right.

■ And I said [REDACTED] lets, you know lets go get you some help and I don't know what he was concerned with if he was just wanting to go get more drugs or what you know but he started getting you know just his mouth,

RS Yeah.

■ He just starts talking and saying things that make no sense but getting louder and louder and that kind of stuff so [REDACTED] told him to get in his rig and he wasn't gonna, he was gonna take off walking and [REDACTED] told him, you get in, he had that black trench coat on and stuff and he um, I guess he dropped him off down the road because he was you know getting irate you know just hollering and stuff and [REDACTED] said just get out then and then I gave a little bit and I went over to [REDACTED] and asked him where did you take him, what happened you know because I had called um Mike Roberts and said could you please [REDACTED] he needs to go, he's just, he's not stabilized and I said I think we need, [REDACTED]

RS Right.

█ [REDACTED]
[REDACTED]
[REDACTED] [REDACTED]
[REDACTED]
[REDACTED]

RS Okay.

█ Usually he's all calm and he's all, you know, hey mom and he'd eat, he's sleeping and he's eating, and he's calm, he wasn't like that at all.

RS Okay.

█ It was like, I'm wondering what in the world you know, [REDACTED]
[REDACTED]
[REDACTED]

RS (Inaudible).

█ [REDACTED]
[REDACTED]

RS Mm hmm.

█ [REDACTED]
[REDACTED] [REDACTED]
[REDACTED]
[REDACTED]

RS Mm hmm.

█ [REDACTED]

RS Cause it was Deputy Berry or [REDACTED] that mentioned to me that he, he made some threat towards the little girl?

█ No.

RS No, you didn't hear, hear anything like that?

█ Uh-uh no I never said that.

RS Okay, okay. Alright [REDACTED] we'll end at zero seven zero six (0706).

[REDACTED] What are they going to do?

End of transcript.

Transcribed on 1/14/08 by [REDACTED] 0608

HUMBOLDT COUNTY SHERIFF'S DEPARTMENT

CASE: 200703162
INTERVIEWER: Rich Schlesiger, Detective
SUBJECT: Attempt PC 187/ Officer Involved Shooting
STATEMENT OF: [REDACTED]
DATE & TIME: June 3, 2007
LOCATION: Hoopa, California

ALSO PRESENT:

RS Rich Schlesiger

[REDACTED]
RS The date here, June third (3rd) two thousand seven (June 3rd, 2007). [REDACTED] is that your full name?

[REDACTED] It's Jacqueline.

RS How do you spell it?

[REDACTED] [REDACTED] last name [REDACTED]

RS And your middle name [REDACTED]

[REDACTED]
RS And your date of birth [REDACTED]

[REDACTED] [REDACTED]).

RS And where you live at [REDACTED]

[REDACTED] Hoopa.

RS What road?

■ [REDACTED]

RS You got a phone number?

■ [REDACTED]

RS What, I really don't know exactly [REDACTED] what's going on, I just pretty much just got here so can you fill me in on how, what led up to all this going on?

■ Yeah you know I, I don't know if you want to go back any about [REDACTED] and his life, and where this started but,

RS We will, we will.

■ Okay so this (inaudible).

RS And your mom right?

■ I'm mom.

RS Okay.

■ Um about maybe a couple weeks ago, you know two months ago, [REDACTED]
[REDACTED]
[REDACTED]

RS Okay.

■ And you know I talk to Willie Hostler a couple weeks ago, I even wrote a letter and everything and I said listen you know [REDACTED] is getting back into you know a bad situation um a year and a half ago, it will be two (2) years this August I believe it was, [REDACTED] uh went into a [REDACTED]

RS Okay.

■ And so I know when he gets into this state, it goes, worse he goes into his minds, and, and he doesn't even know who he is or who I am so I told Willie [REDACTED] unless he poses a harm or threat to himself or you and at that point he was just talking to himself and I was in fear [REDACTED] People get him, like he [REDACTED] and he was starting to harass me, give me my money, give me my money, I'm a director of a family literacy program, I had parents there, all my staff, I said [REDACTED] you know,

finally I said are you going to pay your bills, I'm going to go get food. Well he probably, I don't know but he could have been [REDACTED], I never seen him use it but, kind of given by he lost weight um so I, I you know kept talking to Willie I said please take him out there, he just needs to go to [REDACTED], and he gets straight and [REDACTED] and he starts you know sometimes you know he'll even take a college class and I had him before that, I took him out of the trailer park he was living in the trailer park and I seen him kind of going down hill.

RS Which trailer park?

[REDACTED] The [REDACTED], he had a trailer in there. I brought him to my house you know and he was there for quite a while and he was eating good and everything and then all of a sudden he started swaying away two (2) months ago and he's just started getting acting like this, and so I, Willie said he could only help if something happens so last Saturday you know before that I kept asking Willie, come on you got to pick him up. I understand there has to be a you know a reason a cause, so and I just found out [REDACTED] the one (1) that brought him to my house last Friday night, cause he showed up and I, I was telling [REDACTED] the story, I said gee [REDACTED] last Friday night [REDACTED] shows up at ten (10) o'clock, soaking wet, he was being kind of loud but not obnoxious at that point and I went out and I said [REDACTED] the baby is asleep, please be quiet. I said go ahead and cook, you can sleep here or whatever you know you want to eat. Well come to find out [REDACTED] the one (1) that gave him a ride there soaking wet, and so then four (4) o'clock in the morning he kind of went berserk, he couldn't sleep, my stepson lives in the upstairs room, he's too old to be there anyway, he's twenty seven (27) he's loud, he talks all night on the phone, he's very loud, and um [REDACTED] just kind of went berserk, he goes all I want is some sleep. And he got loud and obnoxious it just got worse, escalated and so at that point I felt that's a [REDACTED] [REDACTED] you know it should be enough for them to come, they did Eddie Guyer came, the ambulance, they came in together. [REDACTED] was standing out there and he goes, he was fine, he was like this just like I found him yesterday and today in coherent and not responsive but you know he, he just said I just, could you just take me you know out of here and this and that cause then I'm the bad guy at that point you know he's mad at me. So they put him in the ambulance [REDACTED]

RS When was this?

[REDACTED] Last Saturday morning at four thirty (4:30) a.m.

RS Okay.

[REDACTED] Okay well they get him to [REDACTED] and [REDACTED] as any situation could happen right, [REDACTED] you know they hadn't [REDACTED] yet so they instantly called Sergeant Armstrong, I talked to him a couple times since then and they could, he couldn't figure out why he was called, he even told me he said I even wrote in there, I, you know I'm picking this guy up [REDACTED] they

brought him to the jail [REDACTED], from Saturday morning till Tuesday. I'm calling Sergeant Armstrong said he's help me, he did, I called the jail I said could you please get a Doctor or someone in there to diagnosis him, it took me that many days, they diagnosed him and sent him right over to [REDACTED] to the hospital. They got him in there and um Friday rolls around and they released him just like that. They didn't,

RS This last Friday?

[REDACTED] This last, just two (2) days ago. They release him, but the time I found him, he, the guy that took off walking he couldn't handle it that's his best friend and his first cousin, he um had been, [REDACTED] says the guy that was in the car, he said you know what it's almost like they needed to keep him longer, I said I know he's not stable.

RS What's [REDACTED] last name?

JA [REDACTED] um,

RS [REDACTED]

[REDACTED] No, no, [REDACTED].

RS Okay.

[REDACTED] [REDACTED] [REDACTED] And I noticed that too. I went over there last night to talk to him, he was sitting there just uh incoherent I said [REDACTED]

RS Went over where?

[REDACTED] To his trailer. I moved his trailer over to Masten Flat where he use to live, he wanted it over there really bad so he, he doesn't even have electricity over there we're trying to get the electricity,

RS What's the trailer look like?

[REDACTED] It's okay, it's a [REDACTED] singlewide trailer, pretty decent. He's got a couple chairs in there, a T.V., a bed in the back I mean,

RS Does he have any vehicles or anything?

[REDACTED] No. Um so he's incoherent so then my other son [REDACTED] came tried to talk some sense into him, he goes come on [REDACTED] it's gonna be dark, you don't have any electricity here, took us like an hour to talk to him, coaxing him, he put on all his clothes. Um I'm kind of, I've taken [REDACTED] [REDACTED] studies and all that so I kind of see when someone's in their [REDACTED], he's putting on all these clothes and it's hot you know he's got several shirts

on three (3) coats, a hat, I said [REDACTED] you can get heat exhaustion you know take that stuff off, and he's like no someone will steal it, in that tone.

RS Mm hmm.

[REDACTED] So at that point I just reasoned with him and I got him a thing of water and filled it up, took him over to [REDACTED] said [REDACTED] can you watch him tonight I said until I can get him,

RS Who is [REDACTED]

[REDACTED] My second (2nd) son.

RS Okay.

[REDACTED] They're not even a year apart they grew up very close. [REDACTED] brings him to my house and I guess during the night [REDACTED] had just sat there and cut up stuff, [REDACTED] clothes this and that and he, [REDACTED] said, brings him home, Mom I can't take care of him. So he's there and,

RS What day was that on, you took him to [REDACTED]

JA Last night.

RS Last night.

JA Yeah and so that was last night; [REDACTED] said he'd watch him.

RS Where does [REDACTED] live at?

JA Over cross from the hospital on Tish Tang.

RS Okay.

JA Okay so then,

RS Same last name?

JA [REDACTED] the dad okay.

RS Okay.

[REDACTED] And um so he brings him to my house at ten (10) this morning, he starts getting all obnoxious all just like that and in a hot second he said hi mom I love you and the next second he was like where's my money, in a whole other tone, that [REDACTED], totally a different person. I said [REDACTED] I don't, I can't have you around the baby, I'm raising my granddaughter she's three

(3), and she started crying, I took her in the bedroom I said [REDACTED] my husband can you please watch her in here. He comes out and he's going to spit on me,

RS Mm hmm.

[REDACTED] You know and I said come on [REDACTED] you know don't do that, so [REDACTED] took him out and dropped him off somewhere, and I, in the meantime I call um dispatch, I said could, [REDACTED] really needs to get back to [REDACTED] he's just not acting himself I said he's, he shouldn't have been released, he's not stable, I said you can tell in his eyes, he's not there, it's not [REDACTED] and so Mike came to the house, Mike Roberts and he tried looking for him,

RS Mike who?

[REDACTED] Mike Roberts.

RS The cop?

[REDACTED] Yeah

RS Okay.

[REDACTED] And um, he couldn't find him in the meantime, he gets a call, only police officer on duty here, he gets a call, has to go out town, meantime then [REDACTED] he makes it up here somehow, [REDACTED]

RS And this is today then?

[REDACTED] Today, this is all in one (1) day, from this morning when I said I called and he came to the house, this is today.

RS Okay.

[REDACTED] So around noon, [REDACTED] called me she said listen, [REDACTED] came in, I didn't recognize him, he's got all these coats on,

RS [REDACTED]

[REDACTED] uh [REDACTED] and [REDACTED]

RS And is that the house [REDACTED] in now?

JA Yes. He was fine, she was trying to get his clothes off cause he was over heated, he walked or something all the way up here.

RS Okay.

■ Um she tried to give him some water, he said I'm just tired, I just want to sleep and she called me she said ■ she was whispering in the back room, she didn't want him to think you know she was doing anything against, you know hurting him because I use to live up here and in old, ■, you know Willie the Chief,

RS Mm hmm.

■ That's his uncle,

RS Okay.

■ ■ use to haul hay for him and stuff and so uh ■ is ■ stepson, so ■ probably felt it was a safe place to go, someone that would talk to him and he said I just want to go to sleep.

RS This, this house here?

■ Yes.

RS Okay.

■ It was a safe place for him.

RS Who, when you got here who else was here besides ■

■ I didn't ever come up here.

RS Oh you didn't.

■ No I called dispatch and I said can you send, cause ■ said you know ■ is not himself he's,

RS Oh, ■ called you?

■ Yes. She said ■ up here, that's how I knew he was up there. I said you know I tried to call the ambulance earlier and stuff and they were looking for him and then there was no officer's on duty, she said you know what ■ she said it's kind of you know he's just not himself, he's not answering much, he won't say anything, he's not responding. They were gonna take him down the hill and then I kept calling that dispatcher, ■ who didn't know much and he said listen I'll send someone up there, that's when I said you got to be really careful, I said send an ambulance with him, this ambulance driver knows him, he brought him out Saturday morning at four thirty (4:30) in the morning, so um he gets to these two (2) white gates here cause ■ was standing down here and she has a cell phone and she's calling me point

by point, telling me, they're not here yet, they're not here yet, so Officer Berry from the Yurok Tribe gets to those two (2) white things and she's standing down there and she's talking to me as he pulls up, and she said here, talk to his mom, so I called, I talked to him and I said this is the situation, he's um [REDACTED], he is a harm, he just want to get him out of [REDACTED] and I said I called Mike Roberts, he knows about it, he was going to deal with it but he had a call out town and so he said okay, I'll wait you know till Mike Roberts gets back and we'll bring a um ambulance up there and we'll deal with it that way, I'd rather do that. [REDACTED] calls me not minutes after that crying and [REDACTED] was up at the house with [REDACTED] and she said [REDACTED] he,

RS [REDACTED] who's [REDACTED]

[REDACTED] [REDACTED] [REDACTED] that's [REDACTED] like husband, they've been together for like twenty (20) years or more.

RS Okay. Are they around here?

[REDACTED] They were told to leave. [REDACTED] is the one (1) that you seen come walk down here, [REDACTED]

RS Okay.

[REDACTED] She, she went up in the brush and has been hiding up there and then got her truck out of there some how, must have been parked up somewhere, so she said he went flying in there, with a siren and the loud speaker and it scared [REDACTED] just like that you don't do that with someone [REDACTED], he went flying in there, totally lied to me, told me lied to me, told me he was gonna wait for Mike and,

RS Well what did, what did uh [REDACTED] tell you was, what was, what was [REDACTED] crying about?

[REDACTED] Because he did that because she just heard him say she was going to wait, he was going to wait for the ambulance and Mike, and he didn't, soon as he got off the phone, he went flying in there, he didn't do anything that he said, I said well you got to be careful, he gets scared, and he said okay, I'll wait for the ambulance and this and that, he didn't, he went flying in there with the sirens, went up to the house with a loud speaker, [REDACTED] come running out cause he was sitting there talking to [REDACTED] trying to you know and he come running out, the guy tells [REDACTED] to get behind his rig so [REDACTED] didn't even you know, get to say anything, hollering and this and that it scared [REDACTED] it scared [REDACTED] he didn't have a gun on him when he went up there, there was obviously a gun in the house and that's when he just pointed it, well it scared him you know, he's seeing the situation and then this escalated to this, that's how it happened, it should've never been like that. Just Saturday morning when they came to my house, an officer and an ambulance, he got in, it was fine, that guy should, I mean and I just through telling him [REDACTED] [REDACTED] and he was just released on Friday, he's shouldn't have been, he's kind of not stable you know and I don't know why it had to escalate like this, it's.

RS What, when you, when did you eventually get up here [REDACTED]

JA Because [REDACTED] was calling me, I was afraid to come up here you know I kept saying, are they going to let me talk to my son, cause [REDACTED] said when it was just that one (1) officer, she could hear him saying [REDACTED] help me. If they would have let [REDACTED] talk to him, he would have been out by now, he was calm then, he goes please [REDACTED] help me, she was calling me on the phone, she goes [REDACTED] and she was telling me he's hollering at me right now, they won't even, she was hiding in the brush, they, that officer made her go up and hide in the brush with her little boy. So I just stood down on my porch calling, she was calling back and forth, back and forth cause I didn't expect it to be like this and I was afraid to come up here you know and, and see this and then finally she calls me, she goes there is S.W.A.T. Team, there's guns, there all standing out there pointing at the house and it's scary, I know he's scared to death. She said it's gotten worse and worse, you need to get up here and so I came flying up here and my ex husband [REDACTED] heard from my son [REDACTED] at the store what was going on and so he came up here but,

RS What, so what exactly happened between uh [REDACTED] and [REDACTED] then?

UM Are your keys in your car?

[REDACTED] Yeah.

UM Can [REDACTED] move your, back your car up so we can get this thing in there, thanks.

RS What, what happened between [REDACTED] and [REDACTED] or [REDACTED] and [REDACTED] for all this, I mean what, what, what were they so worried about?

[REDACTED] They weren't, it happened this morning when [REDACTED] came to my house and Mike Roberts was suppose to get the ambulance and get him um out to [REDACTED] but Mike had to leave, so then,

RS So.

[REDACTED] So then [REDACTED] just called me and she said [REDACTED] what do I do with [REDACTED]

RS So did you go to work, what did you do, how did [REDACTED] ever leave your house?

[REDACTED] This morning [REDACTED] took him out um I said [REDACTED], I took [REDACTED] and [REDACTED] over to [REDACTED] house last night,

RS Okay.

[REDACTED] To see if [REDACTED] would you know come out of it, calm down or what but [REDACTED] fell, went to sleep, him and his um fiancé and he said when he woke up this morning [REDACTED] had you know

like cut up his clothes and this and that, hide his toothbrush and like stuff that [REDACTED] person would do,

RS Mm hmm.

[REDACTED] Like I'm hiding it because someone's gonna

RS Right.

[REDACTED] You know it's this person or he talks to cats that aren't there and he, he brought him over back to my house and so [REDACTED] then, this morning early before ten (10), he came in and he just was irrational and I said [REDACTED] I said I, I need to get you some help and he started real kind of like belligerent to me and,

RS What, what do you mean by that, what do you mean by that [REDACTED]

[REDACTED] "F" ing bitch, give me my money.

RS So he really was

[REDACTED] Then spit at me,

RS So he really has an issue with getting his money then?

[REDACTED] Yes and I told him I said you know what [REDACTED] I said I'll buy your food, I'll pay your bills and everything but at this point you're not stabilized, I don't want to give you money [REDACTED] [REDACTED] or something,

RS Right.

JA I said you know I love you too much for that and this is what's happened for the last two (2) months, you've demanded your money and I don't know you know and at this point I was gonna try to force [REDACTED]. where he will have [REDACTED] and get straight. So I'm the one (1) that initially called to get help and all I wanted was an ambulance to bring him back to [REDACTED] I called [REDACTED] they said bring him back out then. I didn't expect all this to happen.

RS Where, where did this gun come from?

[REDACTED] I, at [REDACTED] and [REDACTED] house, inside of their house.

RS So they, did they know, so the,

[REDACTED] I don't think they knew that all this was going to happen.

RS Did [REDACTED] know there was a gun there or something or?

[REDACTED] Unless it was just laying there or you know,

RS Okay.

[REDACTED] or something and he just seen it you know I, I don't know, I.

RS Does, does [REDACTED] have any other guns like at his house or anything like that?

[REDACTED] The only gun he had was a twenty two (22) and [REDACTED] took it like a week ago when he went in, [REDACTED] went over to his place and he said mom there was a gun there and he said I'm going to lock it up at someone else's house I wanted to get it out of there but [REDACTED] didn't have any on him.

RS Okay.

[REDACTED] You know.

RS What about, you, you mentioned [REDACTED], what, I mean how bad is it?

[REDACTED] I don't know, like I said he's been really straight to the point he [REDACTED], he'll take a class you know he was,

RS You think when he

[REDACTED] Stops taking his,

RS Goes over the edge,

[REDACTED] When [REDACTED], there is vultures in Hoopa and they know when he gets [REDACTED]. and they start trying to talk, come on [REDACTED] I'll, I mean even the guy up there, he told me he said I seen it [REDACTED] right before my eyes, he said oh come on [REDACTED] you know, we'll front you some, we'll front you some so then they get their money by fronting [REDACTED] stuff and they got him on it.

RS Okay.

[REDACTED] Because [REDACTED] he said for the longest time [REDACTED] would say no, no, I don't want to do that well then if you have a problem with it and someone's there waiving it at you all the time and I told Willie that um a couple of people I said oh yeah they were bound and determined gonna be [REDACTED] payee so that they could take all his money you know and

RS Mm hmm.

■ And I said I'm not gonna do that.

RS Well ■ explain to me a little bit more about why ■ ends up there though at ■ and ■ house?

■ Well because when he was um probably thirteen (13) fourteen (14) fifteen (15) maybe I lived up around the corner, way up there

RS Okay.

■ And ■

RS Okay.

■ Willie's uncle, he's a old, old guy, he lives up there and um ■ use to go up there and bail hay, help him stack hay, clean his yards, do all kinds of stuff and, and ■ my mentor you know and help me out in some hard days I had a long time ago, right after my divorce, that was clear back in ninety four (94) ninety five (95), you know and then his stepson is ■ so ■ and ■ were living there in the house down the road where ■ at

RS Okay.

■ And they kind of befriended ■ and ■ was,

RS So they all know each other, that, that's not something odd for,

■ Oh no ■

RS Okay.

■ That's why ■ thought it was a safe place. He'd you know when he was a boy he use to go and visit all the time and um he'd come up here every once in a while you know and you know they loved ■ they seen him grow up and stuff and that's why it just like breaks their heart to see all of this when they didn't want that. They just called, she just called to tell me God what's wrong with ■ he, I never ever seen him like this, I said he needs to go to the hospital,

RS Did ■ explain a little of how ■ was acting?

■ That's all, same way that he was this morning.

RS Kind of just,

■ Just in a zone, you, I'd talk to him, I'd say ■ I need to get you help and he'd go, I'd go ■ look at me. What, what did you, he wouldn't even remember a second later what I was saying.

RS Did uh ■ have a uh ■ in the past?

■ I think that's what caused the most part.

RS Okay, okay.

■ When he turned um eighteen (18) and he gets that stupid Hoopa money he um he just you know he, he kind of, that's what I think caused it. I think that everyone knew the vultures around here knew he got money and anybody and everybody was they're selling him stuff and he'd never used before.

RS Mm hmm

■ You know and he, I'm sure that he never ever wanted to,

RS (Inaudible) was telling me he was an athlete and stuff like that in school.

■ Yeah. He worked at Fishers where ■ works, I was so proud of him, he was only a junior in High School, he worked there and saved up enough for his own Rancho, really healthy young boy, worked I mean he did, he just was, he's got a big heart, you know he just loves everybody and even ■ the guy that was with me and he couldn't handle this, he started crying and took off walking he goes gosh ■ even when he does have money he's always um giving people money you know if they have kids, oh you got food money for dinner, he don't even have much money but he'll hand over whatever he has you know, go buy people diapers and this and that for their kids, so I just

RS So

■ I think that this is what I think, years ago, I think someone gave him some real bad stuff cause I'll never forget it, they took off some people from down Pecwan, he had a ■ car at point, he took off I hadn't seen him for three (3) days, I was at the old house on Masten Flat where now he has his trailer pulled in there and someone come, I and I was asleep, I heard someone come flying in and leave, well they stole his car and they kicked him out and that's when he changed, and I think that they gave him some really, really something that had poison in it, rat poisoning or something because from then on is when the ■ and everything started coming out, and I was asleep and my window was open a little bit, and I heard, it almost sounded like mom, I thought it was an animal and I was scared cause it's kind of back in the dark,

RS Mm hmm.

■ I finally went up and he was laying in a heap, in the road, beat up, I got him in the house, I cleaned him all up, got him some water, propped him up,

RS How old was he when this happened [REDACTED]

■ Nineteen (19).

RS And he's how old now?

■ Twenty six (26). So from then on, I kept trying to get him help, I knew that he had um some kind of disorder from that and everyone even said, that summer, it was in the summer, something happened to [REDACTED] you know it was somebody put some yucky stuff and I think if, if he's taken anything in this last month, I swear that someone put something in it, something really, really bad because he usually will come out of it when he's been in [REDACTED] and he get medicine, you know he's like, "hi mommy I love you" you know and this and that, he just a really sweet boy and so I just, I just hate the drug dealers around here and the people that will give somebody something that's not, you know what I mean, trying to kill his brain and I think that's maybe what's happened here is he's not stabilized at all, something has happened to his brain, worse than you know, [REDACTED]

RS Well that; I was going to ask you that, what, what medications does he currently take?

■ He takes uh a [REDACTED] once a month and he takes [REDACTED], um [REDACTED] and then [REDACTED], and he hasn't been taken that, well since the last week he has been until Friday, and then so,

RS What was the last one (1)?

■ [REDACTED].

RS At night?

■ Yeah.

RS Do you have any idea if he's been taking these?

■ The last time I called [REDACTED] they gave it to him on Friday and I said why did you release him if he wasn't stable yet, and they wouldn't answer me and so I was gone,

RS Did you see him Friday when he got out of [REDACTED]

■ No I didn't expect him out until Saturday, I went over to Butte County to my nephews graduation and so, I'm trying and plus I have pneumonia so I went into the hospital on Thursday,

RS So he was out Friday and he's acting strange already on,

■ He, yeah, he went right to, he went to my house, I wasn't there, so he went to ■ house cause that's Masten Flat, you know there's a bunch of houses up there and he calls ■, his auntie, gram, ■ grandma, he calls her gram, so he went there and he, and that was right after he got out he wasn't even stable, ■ made a comment gosh ■ if he was in ■ why, he's not even stable, he's like doing that, you talk to him and he's like looks down and you're hey are you listening, you know and so he wasn't even stable yet and that was yesterday.

RS Okay.

■ Or Friday he said, and that's why I said,

RS So probably ■ is the first person to see

■ ■

RS ■ out.

■ And ■

RS The grandma?

JA Yeah because I called there on my way back and I was in Weaverville, and ■ said you need to come here and um get ■ she said he was, he was you know for some reason he's not stabilized he's just, he forgets a second later what he's doing, she said he just sits there and zones like this, he's not you know stabilized at all. I said I'll be back that was yesterday, I said I'm in Weaverville I'm on my way home, I'll go right up there, that's when I said I went up there, went out to his trailer, he's sitting there in a zone, he wouldn't listen to me you know he went you know it's wasn't that he wouldn't listen to me, he wouldn't respond, didn't respond at all. It was scaring me, I said come on ■ I don't, I can't leave you here like this and then ■ my boy came, cause he heard you know ■ wasn't doing very well, he came walking in and I go thank you for coming. I said ■ we need to get him out of here, can you talk to him, so he kept talking to him and talking to him and it took like an hour or more to get him up, out of there, he started putting all these clothes on and that's the story I said when I got over to Rich, over to ■ was going to watch him and all the rest happened.

RS Okay. Well before I mean, today it sounds like he was kind of on you a little.

■ This morning.

RS This morning?

■ Yeah.

RS And then what about before he went to ■ how was he acting before then too, kind of the same way?

■ On and off, angry.

RS How long has he been this angry, not, not his normal self?

■ Well I haven't seen all of it, but my son ■ who works at ■ um he would be driving by, he was afraid to even pick him up and people would tell him he said, they said gosh ■ standing out you know out in front of the store and he's talking to himself.

RS Mm hmm.

JA This has been going on for a month. ■ would just be talking to himself, talking to himself, he'd be walking down the road and talking to himself and ■ would come home and tell me other people would tell me things, I said gosh you know something's wrong with ■ I said I know, I can't force him to go out there, I have to have an ambulance and ambulance won't go unless they ■, and so that's been like for the last month, he's been just talking to himself and you know kind of weird stuff.

RS What about, has he been violent towards you or anything like that?

■ Just his mouth, he gets loud and, and mouthy all of a sudden just like it's, it's almost you know strange because it will, it'll, he'll walk in, I love you mommy and give me a hug and everything and then,

RS Just turn around and,

■ Yeah, and you "f" ing bitch, I mean, totally I mean, it hurts my feelings but I know it's not him you know and I'll go ■ you know,

RS But he, he's got a big thing about this money thing though right?

■ Yes.

RS Okay.

■ And he never use to, for the whole time that I've been his payee, it was fine with, I'd go pay his rent when he was in the trailer park, I'd pay his bills, we go out town, buy all his food, he'd get his little, new shoes or new pants, all of his deodorants you know, his special stuff, and then I'd give him some spending money on the weekends and he'd even have money left at the

end of the month and he only gets like [REDACTED], but I had it spread out and I'd write on his little envelope you know what was spend on what. He was cool with that and all of a sudden two (2) months ago and he started and it was because of these friends, and I heard it, [REDACTED] even told me too, one of them is [REDACTED], she came up to [REDACTED] I'm gonna be his payee, your mother steals all his money, and he goes mom don't steal all his money, he pays his bills and stuff and she's one (1) that was giving him dope that's why.

RS Okay.

[REDACTED] So.

RS [REDACTED] do you know [REDACTED] phone number?

[REDACTED] I think it's [REDACTED]). I'm pretty sure it's [REDACTED]

RS [REDACTED]

[REDACTED] Yeah [REDACTED]

RS Okay and what about [REDACTED]

[REDACTED] don't have a phone.

RS Okay where does he live at?

[REDACTED] He lives over on Tish Tang, um it's uh driveway, the last driveway, there's like a gravel pit and stuff, but it's the last [REDACTED] and K'ima W Medical Center, it's on the right.

RS Before the turn off to go down there or?

[REDACTED] No you go down there towards the hospital.

RS So on Airport Road down there?

[REDACTED] Yeah on Airport Road, it's um the first right turn before the dental clinic and K'ima W Medical Center is right on the other side. [REDACTED]

RS Does [REDACTED] got a phone number?

[REDACTED] My house, he lives with me.

RS Okay,

■ Um,

RS

■ Yeah.

RS Okay. Okay ■ is there anything that I haven't asked you, you think would be important for me to know?

■ I don't know I just don't want anything bad to happen to my son and you know and he does have a big heart, he just needs to be stabilized and I didn't want any of this to happen, all I wanted was the ambulance to go and get him.

RS Okay. We'll end the interview at nineteen forty three (1943).

End of transcript.

Transcribed by ■ 0608 on 12/26/07.

HUMBOLDT COUNTY SHERIFF'S DEPARTMENT

CASE: 200703162
INTERVIEWER: Rich Schlesiger, Detective
SUBJECT: Attempt PC 187/ Officer Involved Shooting
STATEMENT OF: [REDACTED]
DATE & TIME: June 4, 2007 @ 0019 hours.
LOCATION: Hoopa, California

ALSO PRESENT:

RS Rich Schlesiger

[REDACTED] [REDACTED]

[REDACTED] I just hope I'm not in trouble.

RS No I don't see a reason for it.

[REDACTED] You know I did everything I could, I put everything in a gun safe.

RS Yeah.

[REDACTED] And locked it, what else could I do?

RS Yeah. Okay [REDACTED] it's June fourth (4th) two thousand seven (2007), time is zero, zero nineteen (0019) hours, we're talking in my vehicle obviously away up from your residence, now this is Bald Hill road?

[REDACTED] This is actually called the Bloody Camp road.

RS Bloody Camp road.

[REDACTED] Neat uh, appropriate for what we're doing?

RS Bloody Camp.

[REDACTED] Yeah. That's where it turns into Bloody Camp when you take the stop sign down here.

RS Okay.

█ Yeah and the rest is Bald Hill, will take you to Orick.

RS Okay. Okay now I get it. Is, is there a house number or anything like that?

█ I know. No.

RS I saw there's an █ on the post there.

█ There's an █ on the post, it's █, Bald Hill pretty much.

RS Okay.

█ Yeah these guys thought I was pretty cool under fire, these guys are like exchanging shots and I'm laying in the grass asleep, I was like it's not that I'm just that cool, it's that I'm that sick.

RS Yeah. █ what's your full name?

█ █ Two (2) █ common spelling. I'm also on probation.

RS Okay.

█ For what that's worth. Nothing super serious um █ knows all about that.

RS What is it for?

█ Um assault, but the same thing, they dropped the charges um,

RS Misdemeanor?

█ Yeah. I did a couple weeks in jail and they just didn't have a case, they had to let me go.

RS Okay. What's your date of birth █

█ █).

RS Okay. You guys don't have a phone up here right?

█ Uh we have a cell phone.

RS What was that again, four nine, nine?

Uh [REDACTED] The only way I can remember is a woman's measurements, [REDACTED]. That's how I can

RS That's pretty good.

[REDACTED] Can remember it.

RS Well [REDACTED] I mean um so [REDACTED] how do you know him?

[REDACTED] Uh God well, let's see his mom and another guy use to live right down here in uh what they call the Latham out, Latham ranch down here.

RS Mm hmm.

[REDACTED] And him and his brothers were kind of like kids in the neighborhood and they use to come up and hang out and watch T.V. and stuff. Um I mean he's kind of a goofy kid, I mean all along but uh just in the last few years, I mean I think [REDACTED]

RS I mean before this time, when was the last time you saw [REDACTED]

[REDACTED] Oh my god, um I see him down town occasionally walking around but here's where, here's where I think he got it in his head that he could come to my house in this condition is one (1) time years ago the cops had had him down town and he had kicked out their windows and run away and he shows up, I guess he went to Harry O's at Beaver Creek, showed up down here at the neighbors and then like four (4) in the morning he's at my house, beating on the door, and handcuffed, his hands are blue and uh I felt sorry for the kid,

RS Really.

[REDACTED] Yes and this years ago, I mean five (5) six (6) years ago maybe.

RS Okay, okay.

[REDACTED] Maybe even longer. He was, he was, yeah about seven (7) years ago and um like an idiot I sawed the shit off of him, I probably shouldn't have, um his hands were blue and it looked like he was going to loose them if I didn't do something for the kid, but he was um obviously doing crazy shit then, um he was al [REDACTED] then and that was, shit that was five (5) years ago probably and he was having problems then but I guess and he, then he started calling, like today he was calling [REDACTED] me and [REDACTED] mom and dad and I love you guys, and I knew he was out there when he grabbed me and like start sobbing uncontrollably and the next second,

RS Let's back up a second,

█ Yeah okay.

RS So how, how long has it been since he's been to your house?

█ Oh uh probably that night years ago when I sawed that shit off of him.

RS Really.

█ Seven (7) years or something yeah, and he just walked in, for what it's worth we didn't let him in, he didn't knock either, and the door was open and I was laying in bed feeling like hell and he just walked in and he looked so different.

RS So who was all down at the house when?

█ Um █ nephew █, uh my son █ me and █

RS How old, what's █ name?

█ Uh █. That's uh █ kid.

RS How old is he?

█ Oh he's ten (10), my son's nine (9).

RS What's your son's name?

█ █ and █ and I mean right away, something I mean he looked so whacked out,

RS He just walks in the front door?

█ Yeah. Walked right in, started wandering around the house, and he has a big coat on and all he said was "trench coat mafia".

RS He said that?

█ Yeah. First thing he said.

RS What do you guys say?

It's like ooh. I had to look at him for a minute and I go who is that, and she goes you know what I don't know and I go, that's not good, so I get up and I walk out and I look at her real, and he has a beard and I can see the muscles in his face just going like this,

RS Clenching his.

Oh he's just so jacked and um,

RS Let me ask you a question, you ever done Meth. before

Sure.

RS So the way he was acting would you say that was a person?

Um I looked at his pupil, I use to drive an ambulance you know I mean, dealing with tweaker's it's like living in this town it's just a fact of life but um seemed to be pretty good, they weren't really blown, they weren't dilated so much but um he was, god he had gloves on, coat, big old boots um a knit hat and it's like seventy five (75) degrees out.

RS Yeah I was gonna say when I came over it was seventy one (71).

Yeah and he's like got all this shit on him.

RS What time of day was this about?

Um one (1) o'clock one thirty (1:30).

RS OKAY.

Maybe more a little afternoon.

RS Okay.

And I was feeling terrible, I mean normally nobody would even, first of all he walked but then I found out the neighbors up here, I asked him how did you get here, and he said oh I walked about half way up the hill and uh, and and uh oh what the hell her name is uh gave him a ride and they let him off at the end of the driveway. Thank you.

RS Yeah. Where do they live at?

They live uh last driveway on left, on this road, you just keep going.

RS How far up?

■ Um about another mile and a half. Willie knows where it is.

RS Okay.

■ Um

RS I'm taking it you guys rent this from Willie's uncle?

■ Uh we've lived here, we don't, I, I pretty much own it. We've lived here for like twenty three (23) years or something.

RS Oh okay.

■ Me and uh Willie's uncle build this place a long time ago.

RS Okay.

■ And ■ isn't uh, he's not, he's just not on, I don't know, he made it all my fault, he came to see you, you know I didn't ask him to come, so he's all bend out of shape thinking I ask him to come up here or something and but I can take one (1) look at him, I mean I didn't recognize him the first of all, first off I didn't recognize him and then he's just talking off, right away, he's talking crazy shit.

RS What's he saying?

■ Oh first of all he said I'm on the run, and I said ■ what did you do this time and he goes no I'm just joking I'm not on the run, and he starts babbling about some other shit and he said um, I said what have you been doing lately, the last, oh the last, just to back up a little bit the last time I did see him down town, he came up with this story about he was watching five (5) panthers run around in his back yard, this, you know let alone see one (1) let alone five (5) he was just tweaked out, gave us this big long story so he was whacked out then but anyway he just started talking about uh, so I kind of, I just it go, I dropped it you know if you're not on the run fine and then he goes I'm really tired and he's sweating and shit, and he just climbs in my bed with me. Yeah. I mean the guy climbs in bed with me I mean just come on in I guess.

RS He comes right in to your bedroom then?

■ Yeah, but then he's walked up and he's, well I had gone out and talked to him right and I go lay down, I'm feeling that bad, and I thought he'd stand there at the doorway and he goes you know what, you know what ■ no you know what dad I'm really tired, can I lay down for a minute and I look at ■ and he's calling us mom and dad and I,

RS Where's ■ at?

██████████ right over here talking to,

RS Nowhere was she at in the house?

██████████ Oh she was um, running around doing something I don't know. We were trying to get laundry done the house is kind of a mess, um

RS What's ██████████ last name?

██████████. And so the guy climbs in bed with me and I'm just thinking my god, and I got up you know naturally,

RS Yeah.

██████████ And then he was just talking and then he goes yep I'm on the run again. I go well you just said you weren't so what's up ██████████ what's the deal and he said I got in an altercation with my mom and I fucked up ██████████ house real bad and so, so, you're uh this is where you came, you just got off the valley floor, he goes yeah, I figured it's cool up here you know uh no body will find me.

RS ██████████ his brother right?

██████████ Yeah and then he said, then he, right in the same sentence, right in the same breath he goes yeah but you know what, I'm not going back, they're not taking me alive, I'm not going back, I'm not going anywhere and right about then he stands up and I'm standing at the door way to the bedroom and he goes because I got this, he pulls out some weird two prong knife that you can flip back and forth, he had kitchen knives in his belt buckles he had um a great big gurrhka knife, I mean a huge fucking thing and wrapped in leather laying on my bed, um he pulled two (2) more knives out of his boots, he must have had six knives probably,

RS Okay.

Mm Um he pulled them on that officer, I mean when he pulled up he pulled that shit right on him, he had a taser gun, he said the hell with that and he pulled out his real gun and he got to within thirty (30) feet and I was telling the guys loaded with knives dude, seriously. And right then you know and he's going (inaudible) I'm not, I'm not having any of that, I'm not and then he was yelling at those cops well later on, but he was telling them move that car, just walk out of here you're not leaving with that car. I was just and the first thing we looked through the window and he's pointing the gun at us, I thought right then I would have probably shot him you know.

RS Mm hmm.

██████████ Yeah I was stunned.

RS So what else is going on out the house while you're there?

Um well anyway I decide that, calls his mom and his mom says that he just trashed us all, we're looking for him, where the hell is he at, he's at our house. Oh that's a drag yeah and I don't know how, you know we figured out how he got there and stuff but I guess he had just totaled out house, caused all kind of problems and um I just told get those kids and that truck and you leave and go down to the end of the driveway, call the cop or do whatever you've got to do but don't come back, don't bring these kids back into this and I'll stay here with him until the cops come or, I really had thought about taking him out, but I realized that he was so heavily armed and tweaked that I would have had to hit him like with Norman Bates with a shovel or something.

RS Were you, were you worried about your safety?

Yes, yes, he became so anyway the cops uh, comes back once and says the cops are coming and said I'm going to head out, okay go, don't come back anymore, I mean it, don't come back. No what you hear or whatever and um

RS And are you guys just hanging out in the house while this is going on?

Yeah I'm trying to calm him down you know and he's talking about how evil he is and all and I said I don't think that's the case at all you know, I was trying to reason with him and you know how people (inaudible) talking to him.

RS Right, right.

And he just said and the he's got these tattoo's on his arm like triangles and he's saying yeah every point of this triangle means twenty four (24) people, that's how many people I've killed, and he starts counting them and pretty soon he just can't even do the math anymore you know and uh he's just talking about yep killings my thing, that's what I do and he's talking about some people that and some other people, oh I'd slash their throats but he lived through it, you know he was talking about murdering all kinds of people that are just fine and walking around right this minute. Um he was just, just god, rambling you know, just on about um that before it was over he was going to have to kill some more people and right about then I was like well where do I fit in to this you know,

RS Mm hmm.

Mm You know and um I became pretty aware of my own safety and I started taking uh, I know the cops are on there way so what I need to do is stall for time, and somehow get these weapons out of his reach, I mean there's like machetes by the, by, there's a hatchet,

RS Stuff that you have laying around the house?

■ Yeah in the house, that we use, I use to machetes to cut pizza or whatever, so I threw all that shit out the window and as he's not looking, I'm, I keep, then he goes back in the bedroom and lays down, I think he's going to sleep, perfect.

RS Right.

■ You know I figure you guys are rolling, we'll have him isolated in this bedroom, I got all the weapons I locked up every fucking gun in that gun safe except for that twenty two (22) that he was using earlier, I forgot all about it.

RS So he's laid down on the bed and you're putting all the guns away?

■ Right, I'm slowly, but he's starting to catch on because uh something, I don't know what it is, I don't know what it is but um I just kept quietly trying to move this shit out of the way, so he won't have any access to it and I think we're going to catch him asleep and I walk back in the bedroom and he's like this, looking out the window something's up, I'm not liking this at all, something's up and I'm what ■ relax, and I got the fan on real loud so he can't hear anything coming.

RS Mm hmm.

■ You know I'm trying to fucking dull his senses, trying to get him on to other ■ I was like ■ why don't you have a sandwich, hoping he'll eat and he'll go to sleep you know but he wasn't having it, um try to get him to drink a soda, like two (2) sips, and then start rattling, sat it down um, then like he, he'd be sobbing you know. I've done, you know I've done speed enough to where, I mean a few times, I never really, just wasn't my thing um, I'm sure everybody's tried it in this county at one (1) time or another but um people like him that aren't too well oriented or balanced you know in the first place, I mean lets face it the shit makes everybody crazy,

RS Right, right.

■ And somebody who is already nuts lets just (inaudible) that's it.

RS Yeah I see what your saying.

■ I mean he's just gone, the poor kid's gone, so I mean I feel for you guys, your gonna, there's no reasoning with him I tried, I mean I was like ■ you know,

RS Did you tell him you know, what, I mean what exactly did you tell him that you'd get him to give (inaudible).

So well here's the thing, so anyway I was stalling it anyway he's, he's standing in the doorway and he's like I know something's up you know and I, I, I got to live here, I don't want him to know that I did it,

RS Right.

You know or did it.

RS Right.

And so he gets up anyway he, he's standing in the bedroom and I go hey go come on in here and sit down you know and what I did is I fucked up the seating is, I wanted to sit in the chair that was facing the driveway and the other seat is facing like up this way, where you can't see anything.

RS (Inaudible).

Yeah and the kitchen and he got the wrong seat on me, he took that seat and he was looking right out the god damn window and um you know, had it been the other seat he wouldn't even have seen you guys coming, you know so that got all fouled up and basically he's just becoming more agitated as time goes on and he could probably sense by now I'm like, I'm waiting you know and I'm thinking I can solve everybody a lot of trouble and go get that shovel and knock him in the fucking head with it, but I figured this guy is so well armed and so tweaked that I have to use lethal force, there's no smacking him the head and if I went with my forty five (45) said hey drop that shit, I don't think, he's going to lunge at me

RS Mm hmm.

And then I have to explain to you guys why I shot this dude in my kitchen.

RS Mm hmm.

So I figured when the cops show up I'm out you know I'm going to try to get there two (2) steps ahead of him and when he saw you guys he spased, looked down and started to become instantly confused and that was my cue, I just fucking ran outside,

RS Mm hmm.

You know and he started, he's like dad what did you do that for, come talk to me, come be with me, come back in here and the deputy looks at me and goes, do you want to go back in there, I said "fuck no I'm done".

RS So he follows you outside?

█ Yep, yeah.

RS Okay.

█ (Inaudible).

RS When the deputy came up,

█ And then the deputy came up with his taser gun and he's pulling these knives, going (inaudible) end of the dragon or some goddamn thing you know and that was it.

RS So where are you standing, where are you standing when the deputy gets there and where is, where is █ standing?

█ Uh I run outside and the cops pull up a lot farther than they wanted to, it took them a long time to get their rig out of there. I ran up as they opened the door and just stood behind the door and I'm talking to them and he's in the doorway yelling at us, you know, "what's this all about, you guys better get the fuck out of here" you know, go away, this ain't your property, blah, blah, blah.

RS So he's and he's brandishing these knives at him?

█ Yep, yep.

RS Okay.

█ And he had a taser gun and the gun said fuck that and he instantly pulled out his Glock and he started to come down the steps a little bit and if I remember right the, the cop said no you don't want to do that and he backed up and he sat a bunch of other shit and he went inside.

RS What was the other shit he said?

█ Um geez it's hard to remember, something about you guys shouldn't have come up here, why don't you guys go away, cause I'm not going anywhere and he shut the door.

RS Okay. What happens after that █

█ Um we're waiting with the, I don't know I forget her name, the Yurok Tribal Police lady UM,

RS Heather?

█ Yeah and the deputy, what's his name?

RS Greg.

Mm Yeah he's real cool, I like him anyway I'm kicking it with them behind their rig and there's just realized that they're to close and um I don't, at that time I remember guess what, I didn't get all the guns, he's asking me what's in there and I told him how everything's locked up and I just remembered my god damn twenty two (22) was up in the gun rack, I completely forgot about it and right about then we look up in the window and he's got that gun and he's pointing it at us.

RS Which window would that be?

■ That's the back bedroom window that faces north,

RS Okay.

■ And, and they were really um at odds to try to get that, that vehicle back up without putting, exposing themselves and that's the only cover we had.

RS Mm hmm.

■ And they felt pretty naked and outgunned um and I had to level with them, I don't know how much trouble, I just told them, there's a gun, there's a gun safe in there that's got an AK Forty seven (47) and an AR Fifteen (15) shotgun with slugs, forty five (45) automatic pistol. (Inaudible) guns I've collected for years, I've had this shit for ever. Basically the only reason I have a AR Fifteen (15), well the AK was you know young, fool I just wanted to have it, but the AR Fifteen (15) we've used to keep the coyotes off these cows for years. With a bolt-action rifle I use to have to shoot at those goddamn things, I'd never get a shot at them,

RS Mm hmm.

■ Now I just start squeezing the rounds off and they just run into it, but I've never taken the gun off the property you know, I've had it forever and ever but I, I just don't, I realize, I hope to get it back you know.

RS Mm hmm.

■ But I'd really feel shitty if he's using it on you guys, that fucker. You know on one (1) hand I feel sorry for this kid, and the other hand fuck, shot the bastard you know I, I'm really, I'm really upset that he decided to do this at my house. I got kids, my little kid's flipped out.

RS Oh I can imagine.

■ Yeah he's really upset and he thinks I'm going to go to jail because of these guns you know.

RS So they back up the, the, the Yurok Tribal car?

At two (2) different times yeah.

RS Two (2) different times and you're standing back behind it?

Mm hmm.

RS Okay. Um eventually you guys stop in one (1) area?

Yeah and I'm really sick, I mean they thought I was crazy cause you guys were shooting it out with this guy and I'm laying down in the grass, I'm just so sick,

RS Got bit by a spider or something?

Oh my god, look at what it did to my fucking leg, I mean it's just horrible, I almost got, it's really weird, I almost got in the ambulance and went to town today but had I been gone, he would have been in there and um the, the AR Fifteen (15) and the um,

RS All that would have been out.

the pistol was out; yeah he would have had access to,

RS Do you usually keep those guns out?

No. Only the pistol at night.

RS Why were they out?

Um that's a good question, I don't even know, I think I was um, actually I had a, I just bought a um, what do you call that a lighted retractable scope,

RS Mm hmm.

That's a five (5) power, it's like a um, it has a bullet drop compensator. The guns real rigged up, it had, the thing about this damn gun, it's got a flashlight on it.

RS Oh yeah.

It's got the post, you can put

RS The (inaudible) too?

No the AR Fifteen (15) got, got lights on it,

RS Oh really?

█ Yeah so it's set up to fight at night, which doesn't help. Yeah if he got a hold of it, here's the thing about the gun safe, what's your name again?

RS Rich.

█ Rich. Is the gun safe, there's a two point locking, it's a, it's a (inaudible) I don't know, about an eighty (80) dollar gun safe from K-Mart but it's got two (2) locking points, one (1) of them doesn't work on the bottom, so if he was smart enough, he could have pried the bottom of that thing out and got it open, you know what I mean.

RS How, how do you open it?

█ I just use the top, I, I, don't, I have to get it fixed; the bottom lock got froze up on me and doesn't work.

RS How, how big is the safe?

█ Oh four (4) foot by, it's no, no bigger, holds about five (5) guns, it's no bigger than this. It's got a top shelf in it.

RS Four (4) foot by,

█ Yeah, it's like uh it's a twenty two, real old Winchester twenty two (22), god there's two (2) twenty two (22) in that house. If he finds that sixteen (16) shot repeater too, goddamn it just gets better. Yeah there's a twenty (20), lets see there's two (2) twenty two's (22's) in that house.

RS Let's back up here okay?

█ Okay.

RS The guns that you know are outside of the safe for sure are what?

█ The twenty two (22) that's it.

RS Twenty two (22) rifle?

█ Yep, rifle with a um variable three (3) to nine (9) scope on it and it is accurate. I use it to kill squirrels, I can shot them in the head at like a hundred yards with it, it's dialed. That's probably what he was shooting at you guys in the first place with, up the hill, I don't know.

RS Okay that's what your pretty sure was, is out?

█ Yes. I, absolutely I feel, I feel so shitty that I forgot that thing.

RS In the safe would be an AK Forty seven (47)?

█ Yep, an AR Fifteen (15), um Mossberg five hundred (500) pump shotgun, military police gun, uh forty five (45) automatic.

RS Hold on a second.

█ Okay.

RS A what now?

█ Forty five (45) automatic.

RS What, what brand?

█ Oh it's a um, that's a good one, what the hell, I just got brain fade right now I'm so tweaked out on this, it's um, it's a good one, how dumb, I really, it's uh oh man, I can't, can't remember that. It a T.R.P. a tactical response pistol, it's a uh, um (inaudible) armory.

RS Okay.

█ It's like a thirteen hundred (1300.00) dollar gun. It's got the tritium night sights, which doesn't help you guys either,

RS No.

█ Fabulous pistol. Took me a year to get the hang of it.

RS What was it Springfield Arms?

█ Yeah Springfield Armory, it's a uh tactical response. It's uh; I guess it's a S.W.A.T. pistol I don't know.

RS Okay.

█ But (inaudible) it's a seven (7) rounder you know nothing extravagant.

RS Anything else?

█ Mm there's a twenty, (20), there's a sixteen (16) shot Winchester twenty two (22) rifle in the gun safe too, and there's lots of slugs for the um shotgun.

RS Okay we'll get to the ammo in a second.

█ Okay.

RS Is that all the guns?

█ Um that I, yep that's it.

RS Okay. Ammo, there's what?

█ There's no ammo for the AK thank god, none that I know of, um there's forty (40) rounds in a double clip set up on the AR fifteen (15), there's twenty (20) in each clip, and there side by side, you just switch them over, uh.

RS Is that in the safe too?

█ Yes and god damn here it is and what I should have done was took it outside and threw it in the grass I could have gave it to the deputies to defend us with you know. He felt really naked, he probably would have used it, anyway um I should have taken the clip apart and hid that but I threw it in there all together, which isn't good but I was in a hurry.

RS Right no, I can understand.

█ I was trying to get this shit out of there uh,

RS How much twenty two (22) ammo?

█ Uh oh there's lots, I just bought four hundred (400) rounds, but they're um most of that's locked up too but there was a couple boxes and the clip to the twenty two (22) in the top drawer of the dresser on the right and the guns in the rack above it so. If he was rummaging around it wouldn't take him shit to find it and apparently he did.

RS How many rounds would you say?

█ Oh there's three (3) fifty (50) round boxes probably out there, the thing is the guns filthy, it only shoots um three (3) and four (4) rounds without jamming, now had I cleaned it'd been shooting seven (7) rounds like (inaudible) this guns really dirty it's a cheap Remington that doesn't work well when it's dirty, thank god. He probably,

RS But it does get dirty quick though huh?

█ Yeah and it was filthy to begin with, but like I said the scope is, is, is uh zeroed in very accurate.

RS Okay.

█ I feel like shit if he's using this shit on you guys, but you know I did all I could to keep the shit away from him other than to just throw it out the back door, I probably should have done that, cause Willie said what he shot last time was big, it wasn't no twenty two (22) so he got a hold of something I guess.

RS Okay.

█ Oh ammo for the AA and ammo for the forty five (45) there's like um I don't know, nine (9) rounds in a box, in a cupboard and there's like um two (2) clips, there's like about maybe twenty (20) rounds total. I think that's it. There's lots of slugs though for the, for the shotgun, there's like three (3) four (4) boxes.

RS Outside?

█ No it's in the gun safe.

RS In the gun, how many, how many rounds of slugs?

█ Oh I don't know maybe twenty (20) twenty five (25).

RS Okay now this, so what color is your safe?

█ Brown,

RS Brown.

█ It's a brown Hallmack, and if he had the presence of mind to pry it open he just might, might have been able to do that. He's had the time.

RS Oh yeah, yeah.

█ Did you guys cut off the juice to the house?

RS No I don't think so, not yet I think,

█ Probably be good if he did turn on a light, you could see him better.

RS Yeah and we were also worry about █

■ Um I, I am too. He's all real mad at me, he's just furious at me about all this he's thinking I did it all.

RS And so it has two (2) locking mechanisms on it?

■ Mm hmm, yeah there's and upper,

RS One (1) that works and one (1) doesn't?

■ Yeah the one (1) on the bottom is not functioning, but to look at it you can't tell, to look at from the outside it looks perfectly functional.

RS Mm hmm. So if he pulled on it a few times or?

■ Uh

RS Would he think oh I can get into it or?

■ You know like his state of mind, it's like uh yeah if he had the presences of mind to maybe work on it a little bit, um if he can get that bottom cause it's not you know we're not talking (inaudible) and steel here, you know if he can get that bottom uh the thing is I have like a bucket of carpentry tools which isn't to far away and

RS Oh really.

■ Yeah which is not helpful there either and I mean he could just take a hammer and just get to work on it, we haven't heard any of that that I know of but um,

RS I mean as far as I've heard I don't think we've heard any like,

■ No pounding.

RS Nothing like that no.

■ Okay. Uh he'd have to get a pretty big crow bar and like pry just the corner back and maybe get a gun out of there, but that AR fifteen (15) a full length, it's no, it's no shorty.

RS Okay.

■ It's a full length rifle.

RS So the main thing we're looking at for sure is a twenty two (22) that can jam after three (3) or four (4) rounds,

█ Yep.

RS Once it gets dirty, probably four hundred (400) plus rounds in the house?

█ Yeah but like I said the majority of that is locked up too, there's only about one fifty (150) rounds out.

RS Okay.

█ The majority of that shit's locked up too. Cause I mean I've got kids you know I can't

RS Right.

█ Leave this shit laying all over the place, that's why I got that gun safe but I didn't really envision this.

RS Right.

█ Like god.

RS So eventually going back to is that everything ammo and (inaudible) wise?

█ Um yeah, I can't, there's a um I got a marine shoulder holster that's got a pack, you know you can carry a couple clips in that.

RS What about the body armor?

█ Oh yeah shit there's um I got that on kind of a fluke, you know it's um, it's a I guess it's a regulation three (3) body armor, it's um, it's in the corner with a bunch of clothes on it, hopefully he never saw it. It has no plates. It has, it has pockets for the, for the uh

RS Trauma plate?

█ Trauma plate yeah but there's nothing there.

RS And it's in where the bedroom?

█ Yes. The same window, he was, it's right by the window that he was uh pointing the gun at us. I don't even think the thing even fit me, I don't even know why I have it.

RS Okay.

█ But anyway is that like illegal too or something?

RS I don't know if that is or not.

█ I, I don't know either.

RS I don't' keep up with that.

█ God to think that he's got body armor on and an AR Fifteen (15) would just be horrendously horrible, crazy fucker, and he just kept talking about um he's not going, he's not going back.

RS What about this fake grenade?

█ Um I bought it out of Sportsman Guide you know kind of a conversation piece. All I did is okay they got the holes in the bottom?

RS Mm hmm.

█ All I did is takes some candle wax and fill it in so it looks like there's something in it.

RS Okay.

█ That's it.

RS Okay.

█ It is, it has the pin and everything but you know you can unscrew it and look right at it, the, the fuse is pinched off and everything.

RS Okay

█ There's nothing in it.

RS So there's no, is it a key safe, is it a combo safe?

█ It's like uh, you know what a Harley key looks like, it's round with a little togs on it, it's um, it's like a uh, I could draw it.

RS Oh do you use a key on it or something?

█ Yeah.

RS You do, you do use a key?

█ Mm hmm.

RS And where's that key at?

█ That's, that's the thing too you know I was trying, I was trying to do this so fast and be so sly and I didn't have an pockets on me and I didn't want him to see me with the keys so I locked that stuff up and I where I normally put it, is up into the closet up high, most people can't reach that shit, this time I was so afraid of him finding it, I reached way back there, there's a hot water closet there,

RS Mm hmm.

█ I reached way back there and put it behind the pipe on the hot water heater. Boy I hope to fuck he didn't find it, that would just be, be (inaudible). But I did hide it in that room, there again that's another mistake.

RS The bedroom?

█ Yes.

RS There's a hot water heater thing?

█ Yep and it's right behind the, right behind the exhaust pipe on it. And I mean I just felt like such dog shit and then I just it's hard to think in this capacity. I just kept saying to myself, what a day to be sick, oh my god.

RS So you got bit by a brown recluse?

█ Something it's just made me so ill. I'm starting to feel a little better.

RS Petty nasty looking.

█ Oh it's horrible.

RS So he's wearing, what kind of clothes exactly?

█ That's another thing. This guy is wearing a wetsuit, he's wearing trunks, comes up to the T top he's wearing a fucking wetsuit, yeah for swimming in the river to escape and then he's got on like brown pants with big boots which are full of knives um he had a trench coat on, he had a um a knit dark colored cap.

RS What, did he tell you he was wearing the wetsuit in case he had to jump in the river?

█ Yeah after he took off half his, half his stuff, he started heating up in the house and cause I was sick, I made █ build me a fire I was so,

RS Mm hmm.

■ So cold and he got hot and started striping off some layers, and he's got this wetsuit. I mean he's like um, I don't know it's almost like he's pre mediated, he wanted an incident of some kind you know.

RS Did ■ did you ever hear any gun shots?

■ Oh yeah.

RS When, when was that?

■ Um the first time they exchanged fire, I don't know who was shooting at who really, but I heard, yeah I heard him shoot at them, the first time, one (1) two (2) three (3) or something, and then the second exchange was just before dark probably.

RS How many shots did you hear then?

■ Oh I don't know three (3) four (4) rounds maybe. I don't know if they were returning fire on his or not I don't know. I just, you know what I hope this guy doesn't do is burn my house down. I was thinking about that, getting the fire department up here would probably be hard to do huh, they're all volunteers and shit.

RS Yeah I don't know how long they (inaudible).

■ You know and I just hope I did the right thing, but I don't know if I did or not. You know what if I just hit him in the head with a shovel, and then there's like two (2) people coming to visit at your house, you just sit them down and hit them in the head with a shovel, everything up to them was kind of speculative you know what I mean?

RS Right.

■ But he was there he had a, he just I, in the last year I've only seen him like four (4) times in the last year and each time I see him. He's progressively worse you know he's just worse and his mom's a nice lady, worked real hard, which is rare in these parts you know she's uh, she comes from a good family and that shit just ate up his brain.

RS Yeah.

■ And the guy is still doing it, seeing how miserable he is and I was trying to tell him you know what ■ you've got to give that up. You know there's no way you're going to learn to live like that and you're not normal, and you know what I mean.

RS When he was, when he was pointing the guns at you, the deputies and you, did you think he was going to shoot?

█ Um at my, at that time I was comfortable cause I didn't think he found the ammo.

RS And did, did you hear a clicking noise or anything like that when he had the gun?

█ Um not then cause the window was shut but he came outside after that and went (inaudible) a million times.

RS Was it a bolt action or something?

█ It's a semi-automatic, supposedly a ten (10) rounder but it's a cheap ass damn thing, it's a, supposedly holds ten (10) rounds, but I can only get it to hold four (4) or five (5). Doesn't work for shit, but it's a semi automatic uh twenty two (22).

RS Okay.

█ Has a little plastic clip that he probably found too. So what do they figure they're gonna hit this dude at daylight or what?

RS (Inaudible)

Mm Or are they just going to talk, try and talk to him I guess.

RS Yeah (inaudible)

█ take as long as it takes.

RS I'd imagine so I'm yeah, I don't know you know I don't get to get involved in that.

█ That, that's kind of his call, it's all, I wish he'd just come out. I'd talk to him but you know what, I was talking, I was trying to talk to him when the deputy, those two (2) guys that the lady Heather and that, that one (1) guy, Greg and um he just wasn't listening to me either, he, I can't believe you did this to me, what are you doing, you know, come back in this house. He wanted me to come back in there I wasn't going back in there.

RS Mm hmm.

█ And uh I tried to talk to him, come on █ there's no way out of this just come out, just, I mean what are you doing. I just kept asking him that, I just kept asking him that, what are you doing dude.

RS Yeah.

█ And all he kept saying was back it up, you guys leave but you're not taking them rigs with you. This guys' about to hit you. Almost.

RS Close.

█ Um and he just kept saying that, I'm not going back. Where ever that is.

RS So eventually there's some other deputies or SWAT Team members that come over and, and you took off up towards Jasper's or something like that?

█ Yeah well I went up once, they asked me to go inform him, tell him to lock his doors and don't come out of the house, so I went up there, told him what was going on and he flipped out on me and he's all mad at me about it, and uh I went back down there and I slept on the side of the road for an hours probably, I felt so shitty but um I didn't know really what to do and they said well you can hang out, you're in a good safe spot just stay right here for now you know, you've given us good information, I drew them a floor plan um I helped them as much as I could and then it's like, then I started hearing the big, I thought you know, he started pulling guns, he found my shit and that just, I was feeling so bad I just you know what, and I heard █ up the hill, I went up to █ and called her one (1) time, she said we're right up the hill, just walk up through the horse pasture and we're in the truck up on the, up here. So that's what I did, that's how I got out of there. I told Jasper I'm out, I'll see you, we'll give you a call and that's how I came down this way.

RS Okay. Well keep your cell phone on tonight.

█ Sure no problem. We're just um, we're right down the neighbors house, we're like um a mile from here.

RS Okay, okay.

█ If that.

RS Okay. Um is there anything that I forgot to ask you or anything like that would be important for me to know?

█ Uh shit. As far as like a million places to hide in that house, there isn't.

RS Okay.

█ You know. Um like the one (1) bedroom when you go in, where my king size bed is where that, there's no door on that, so it's kinda open. Um approaching the front door is a bitch because there's a uh well the deputies got the floor plan but there's a window right by the steps,

so you can stand back in the hallway and look right, you can see him and he'll look right out that window and see anybody coming to the front door.

RS Okay.

■ I mean that's tough to approach it and the back door is an outside, what do you call that, it comes up to the, the strike plate like this,

RS Mm hmm.

■ So the idea of kicking that door in is going to be a bitch.

RS Okay.

■ But the front door is easy; you can get right in it,

RS Okay.

■ Probably blow right in it, but um that's something I wouldn't want, I mean they're hopefully going to gas the dude first right, I would think if he doesn't come out, hey we're going to and nobody is going to withstand that and they'll just gas him and he'll come out, now where he comes out blazing or not,

RS True.

■ That's all up to him, um if they want me to I'll try and talk to him, he's always looked up to me and I don't really know why.

RS Yeah, yeah I mean you, you never know and that's why I said you know keep your phone on and,

■ He was trying to talk to ■ too and you know if it will save his life, fine.

RS Okay.

■ But what I'm worried about is this kid coming back to haunt me later and I could see it in his face, he's like op you knew, you knew they were coming and I did.

RS You, you could tell it was,

■ He figured it out, in, in his demented state that he's in, he's somehow figured out that the Calvary was coming, yeah and I had like there's um, like I said there's machetes thrown out the window's. I was grabbing screwdrivers anything I could think of that he could use on everybody; you know I was trying to get rid of it. Um there's like ax's and mauls in the front yard for

splitting wood, there's just shit all over you know. Thank god um, I just hope, hope to god he only found the twenty two (22) and that's it, but from what Willie said it sounds like big shit, he got into something.

RS Yeah it could have been. All right [REDACTED] I can't think of anything else unless you can.

[REDACTED] Other than he's, he's just not rational. You're just not dealing with somebody's that's got a full deck and he's just really um what's the word, fatalistic, he's really wants to die I think.

RS Yeah and you mentioned something to me before we started talking is as far as how the two responding officers handled the situation, you thought it was pretty, a lot of restraint?

[REDACTED] Oh yeah I thought so, actually had he pointed that gun at me, I wouldn't have shot to killed him but I would have blown that window out and let him know we're not fucking around.

RS Mm hmm.

[REDACTED] I guess maybe that's why you guys are cops and I'm not. You know you could have got your point across without having to kill the bastard I think and I think he showed a lot of restraint yeah,

RS Okay.

[REDACTED] And they hung right in there for a long time, they were real nice to me. I don't know I feel like shit cause the guy, I, I, you know he's like so is there everything, those are all the guns accounted for all of a sudden yeah, and I look up and he's pointing a gun at us. I think I forgot one (1).

RS Mm hmm.

[REDACTED] I felt like shit, you know I apologize a thousand,

RS Well you know I mean you tried all you could and you know,

[REDACTED] I forgot one (1).

RS Yeah. All right [REDACTED]

[REDACTED] Okay.

RS We'll end the interview at zero one hundred (0100) hours.

[REDACTED] Um you guys need to talk to me I'm a mile away.

RS Okay.

■ No problem.

RS Cool.

End of transcript.

Transcribed on 1/11/08 by ■ 0608.



HUMBOLDT COUNTY DISTRICT ATTORNEY'S OFFICE INVESTIGATION REPORT

DATE: July 2, 2007
CASE: HCSO #200703162
[REDACTED]
WITNESS: Eddie Wilson, Eureka Police Department

DA Investigator: William Honsal

On June 12th, 2007 at 2200 hours, I interviewed Officer Eddie Wilson, Eureka Police department, regarding HCSO case # 200703162. The interview was recorded on cassette and the following is a summary of his statement. For a detailed statement refer to attached transcript of the interview.

Eddie Wilson is currently employed as an officer with the Eureka Police Department. He has been employed as an officer for 8 years. He is currently assigned as a hostage negotiator. He has received specialized training as a hostage negotiator from the POST school in Monterrey. He has also attended Crisis Intervention Training, in Redding CA. Wilson has been deployed as a hostage negotiator on one prior incident.

On June 3rd, 2007, Wilson received notification of a SWAT callout. Sergeant Nova advised Wilson regarding the incident. Sgt. Nova requested EPD Negotiators Kay Howden and Wilson respond to the scene to relieve the HCSO Negotiators and assist EPD SWAT.

At 0030 hours, Wilson responded with the SWAT team from EPD to the incident site, just north of Hoopa. Upon arrival at scene, Wilson and Howden met with the HCSO negotiator, Deputy Daniels, at the Command Post. Daniels briefed them on the situation. The briefing included the fact that the [REDACTED] had fired shots at two patrol vehicles that were parked down the driveway from the residence. It was decided at the command post that due to the poor lighting, and the officer safety challenges, Officers were not going to actively negotiate with [REDACTED], unless he contacted the police or wanted to surrender.

At 0245 hours, Wilson and Howden responded to the Southeast side of the residence. Howden and Wilson stood to the rear of the Hoopa Tribal Police SUV. Their orders were to remain quiet at that location unless the [REDACTED] presented himself. Howden and Wilson stood by out of sight throughout the night. On occasion Wilson looked up and observed the Windows on the #4 side. Wilson observed some lighting coming form the windows and on occasion he observed "shadows" casting in front of the window.

During the time they were deployed Wilson did not see or hear the [REDACTED] attempt to talk to the police or to surrender. Wilson did not hear any shots fired or gas deployed during the night.

At daylight, they observed that their position put them in harms way. Wilson and Howden then moved back out of sight from the residence.

At 0700 hours, Sgt. Higgerson, California Department of Corrections, relieved Wilson and Howden.

Disposition: Supplemental report referred to HCSO.

1
2
3
4
5
6
7
8
9
10
11
12
13
14
15
16
17
18
19
20
21
22
23
24
25
26
27
28
29
30
31
32
33
34
35
36
37
38
39
40
41
42
43
44

INTERVIEW WITH EDDY WILSON

Q=Inv. B. Honsal

A=Eddy Wilson

Q: Can you hear me, Eddy?

A: I can, Bill.

Q: Okay, cool. So, ah, you're on tape right now. And, ah, so we'll just cover it from, ah, here on out. And, ah, are you off the air?

A: I am off the air right now.

Q: Okay, cool. So it is – what is the date today, the 12th?

A: Twelfth now.

Q: Yeah, okay. It's June 12th, 10 pm, 2200 hours. I'm talkin' to Eddy Wilson via phone. And, ah, this is being recorded. Wilson, can you spell your last name for the record please.

A: It's W-I-L-S-O-N.

Q: Great. And, ah, were you working, um, on or were you called out on June 3rd of this year to respond to a Hoopa regarding a barricaded [REDACTED]

A: Yes, I was.

Q: Okay. Were you, um – ah, who notified you of that?

A: Ah, when I came in for work that night approximately 830 (unintelligible) briefing orders that there was a standoff that our SWAT team, ah, had been requested by the Sheriff's Office.

Q: Okay. And, um, did you – ah, what time did you – did you get deployed with the team?

45 A: Ah, I did, which is, ah, our common practice now. If they go somewhere, we
46 go too. Um, so I was – myself and Kay Howden were, ah, activated. I was
47 basically taken off, ah, patrol that night. And so our deployment didn't occur
48 until about, ah – I think that we got deployed about 1230 or 0030 and then, ah,
49 left some time shortly after that for Hoopa.

51 Q: Okay. And, ah, what was your role? Ah, why – why were you called out to
52 assist?

54 A: Ah, my role was as a negotiator. And I believe my job at that time was going
55 to be to relieve, ah, SO negotiators who were still there on the scene.

57 Q: Okay. So you were – you're a trained hostage negotiator?

59 A: Yes.

61 Q: Okay. Can you briefly describe your law enforcement experience and what,
62 ah, if any, training you, ah, received to be a hostage negotiator?

64 A: Okay. Um, initially I, ah – I spend six and a half years for law enforcement
65 experience, ah, with the Arcata Police Department on patrol. Um, I've been
66 here, ah, working now two years, um, after tomorrow and, um, have since
67 been, ah, trained as a negotiator. I went to a – attended a 40-hour course in
68 Monterey, California, ah, training just basic negotiations and have since, ah,
69 negotiated with one fire, ah, barricaded subjects, one actual negotiation that
70 based on, ah, not just my, ah, day to day experience with dealing with people
71 in crisis and stuff like that. I also, ah, have training and experience in, ah, CIT
72 or crisis intervention training where I attended another, ah, I believe a 32-hour
73 course in Redding, California earlier on, ah, last year.

75 Q: Great. And do you receive, um, any kind of update training by – by your
76 department?

78 A: Um, we are preparing to implement, ah, more of a quarterly training. Right
79 now we're in transition of a, ah, new, ah, person taking over our team, um,
80 since, ah, Sergeant (Derbert) left. So that – that's – we are – that's kind of in
81 the works right now.

83 Q: Okay.

85 A: But I do – I think I'm scheduled to go to a, you know, an advanced, ah, school
86 here pretty...

88 Q: Well good deal. Okay. So, ah, you were deployed up with the team at, ah,
89 midnight 30 hours I guess that would be on June 4th.

- 90
91 A: That's correct.
92
- 93 Q: And then, ah, you arrived some time early morning. And then once you
94 arrived wo – did you receive any orders?
95
- 96 A: When I arrived, ah, basically our SWAT guys who are deployed by Sergeant
97 (Nova), we met with, ah, the SO negotiators. Ah, (Jason Daniels) was one of
98 'em (unintelligible) basically briefed us. And – and basically we met them at
99 the SO command center, which was parked a ways from the scene, but, ah,
100 basically the outer perimeter and were basically getting briefed on, ah, what
101 had happened prior to our arrival.
102
- 103 Q: Okay. And, ah, what – what was – what'd the briefing consist of, or what –
104 what'd they say regarding to this incident and, um, any of the [REDACTED]
105 actions?
106
- 107 A: My understanding at the time was that they – that initial arriving units earlier
108 in the day, ah, had responded there and that, ah, the [REDACTED] who was now at
109 that time barricaded within the residence, had, ah, taken – taken shots at, ah,
110 two marked patrol vehicles that were parked down the road just a short ways
111 from the residence. Ah, my understanding at that time is that negotiators from
112 the SO had, ah, attempted via PA, ah, to basically go right into what we call
113 surrender phase and try and encourage the [REDACTED] to, ah, you know, put down
114 his gun and come out of the house. Um, at that time, ah, basically due to the
115 lighting – poor lighting due to the environment itself, ah, I believe a decision
116 was made for us not to make any attempts to actually negotiate unless he
117 initiated something with us. They didn't want him to come out during the
118 darkness and us not to have the ability to, ah, you know, give our position
119 away with lighting in order to light him up to get him to come out or to
120 (unintelligible) him through, whatever we needed to do to get him, ah, in
121 custody. So our job, ah, was to go into the inner perimeter. And we were
122 actually behind the second vehicle that had been shot at. It was – it was a
123 marked tribal vehicle.
124
- 125 Q: Okay.
126
- 127 A: Um, we took up position there. And our job was going to be, if he did present
128 himself, um, was to make attempts via the PA to once again, ah, go right into
129 the surrender phase, ah, to get him to come out. But we weren't going to
130 solicit that by us doing anything. We were basically there just in case and to –
131 to basically dispel the, ah, SO negotiators.
132
- 133 Q: Gotcha, okay. So how long were you there, um, in that position? I guess that
134 would roughly be on the south side of the, ah, structure where the ho – where

135 the – the [REDACTED] was barricaded? How long were you in that position behind
136 those cars?
137

138 A: I remember actually getting in position by the cars by about I think it was
139 about quarter to 3 I want to say – quarter to 3, maybe roughly 3 o'clock at the
140 latest at that time.
141

142 Q: Okay.
143

144 A: And we remained, ah, in that initial position behind the second vehicle until
145 daylight broke. And in that time we're gonna be dark, and so we could see the
146 [REDACTED] um, moving about inside the residence, um, never made any attempts
147 to con – communicate with us, never, ah, fortunately enough, didn't shoot any
148 more. Um, we – but you could definitely see him moving about. And, ah, at
149 one point in our time that the lights went out in the residence and we no longer
150 – we no longer had a visual inside.
151

152 Q: Okay. Can you describe the [REDACTED] ah, actions inside? And – and was
153 there more than one person there, or was just one? And, um – and how could
154 you see him inside?
155

156 A: I could only see a shadow. I could just see the – the silhouette of a – of a
157 [REDACTED] – one [REDACTED]. I don't know male, female, or what. I'm guessing, um,
158 you know, my assumption is it was the [REDACTED] I don't know if there was
159 anybody else in there. Um, obviously I was at a distance, so I could not see
160 clearly. But this is just...
161

162 Q: We're almost done, Eddy.
163

164 A: Okay. Ah, so, you know, I couldn't see exactly what was going on, but
165 enough that from our visual we could see somebody moving around inside,
166 ah, just kind of, you know, pretty rapid movements back and forth in front of
167 the light in time. Sometimes he'd go, you know, still for quite a while. Then
168 at times there'd be a little bit of movement until that eventually carried
169 through to where it went dark inside the residence.
170

171 Q: And what time do you think it went dark?
172

173 A: Um, we were there for probably a couple hours before that finally occurred.
174

175 Q: Okay. And one last couple follow-up questions. Um, at any time did the
176 [REDACTED] surrender, yell inside, ah, that he wanted to give up?
177

178 A: No...
179

180 Q: And I...

181

182 A: ...not – not in the time that I was there.

183

184 Q: And, ah, if he did choose to yell or give up, were you in a position where you

185 could have heard him?

186

187 A: Bill, I – I'm sorry. I couldn't hear you, Bill.

188

189 Q: If – were you in a position where, if he wanted to yell from the inside, that, ah

190 – that he give – that he wanted to give up, could he have – could – could you

191 have heard him from your position?

192

193 A: I – I believe so, um, only because – and in that briefing I forgot to say this –

194 we, ah – I think (Jason Daniels) told me that the [REDACTED] at some point had

195 yelled for them to, you know, come and get some, mother fuckers.

196

197 Q: Mm.

198

199 A: Um, and that was – they were able to hear that. That was passed onto us when

200 they briefed us on the situation in the inner perimeter there. So, ah, my – I

201 believe that we were cycling close enough based on that information that, if he

202 would have yelled or made any verbal contact, that, ah, we would have heard

203 him.

204

205 Q: Okay. And during the time where you're there were any shots fired?

206

207 A: No.

208

209 Q: Okay. So the [REDACTED] didn't shoot. Neither did the police.

210

211 A: That is correct.

212

213 Q: And where – was any gas administered?

214

215 A: Not in my time there.

216

217 Q: Okay. And so at some time you, ah – you were told, ah, to break down off the

218 perimeter?

219

220 A: That's correct. When it became daylight, it became very much an issue with

221 us being – at that time we had no – as negotiators, we were in the vehicle

222 behind where they had the posted SWAT perimeter. So we, ah, you know,

223 had Kevlar helmets, (TET) vests. But we were also kind of sitting ducks there

224 so to speak in the – in the light at least. In the darkness it was okay, but in the

225 light it became an issue. So Sergeant (Nova) made the decision to pull us
226 back – back to where the – an SO vehicle had stopped and then respond then
227 with the back of the tribal vehicles...

228
229 Q: Okay.

230
231 A: ...those that were on scene initially when shots were fired earlier in the day.

232
233 Q: I gotcha. So you never made contact with the subject.

234
235 A: (Unintelligible) Ah, I never made any verbal contact with the [REDACTED]

236
237 Q: Okay. Did, um, your partner, ah, Sergeant Howden, did she make any verbal
238 contact with, ah, the [REDACTED]

239
240 A: No, she did not.

241
242 Q: Okay. So then, um, at what time did you finally clear the scene?

243
244 A: We were relieved officially, um, I would say that, ah, some time after 8
245 o'clock in the morning, ah, CDC negotiators arrived on scene.

246
247 Q: Okay.

248
249 A: We went ahead and pulled back completely as they came in transitioned. Our,
250 ah, perimeter SWAT guys were being now relieved by the, ah, SO SWAT
251 team who had been, ah, taking a break. And so I was – we were official back
252 in – at the command vehicle some time after 8 o'clock.

253
254 Q: Okay. Ah, do you have anything to add on what you saw, any observations,
255 [REDACTED] residence, anything like that that you wanna add to this?

256
257 A: Not that I can think of, no.

258
259 Q: Oh okay. Well that'll conclude – the interview is over. It's 10 after 10. Turn
260 off – turn off the tape.

261
262
263 This transcript has been reviewed with the audio recording submitted and it is an accurate
264 transcription.

265 Signed _____

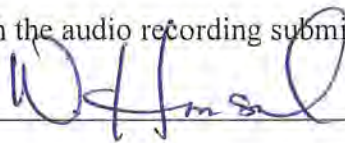

██████████ was described as an Indian Male 20 years old, 5'-08" tall and slender build. Officers were given a color photograph of ██████████ and officers were advised that ██████████ was the only person still inside the residence.

The rules of engagements were discussed at the command post. EPD SWAT's primary role was to deploy around the residence and relieve the sheriff's tactical team during the night. The SWAT team was to observe the residence and report any ██████████ movement or contact. If the ██████████ wanted to give up they were in a position to take him into custody. If the ██████████ exited the residence and threatened deadly force or shot at the officers, they were authorized to protect their lives or the lives of other's in accordance to EPD use of force policy.

Officer Wilcox and the EPD SWAT team then deployed around the residence at approximately 0300 hours where they relieved the Sheriff's deputies. Officer Wilcox deployed with three EPD officers to the South side of the residence (Side #4). Other EPD officers took positions on the Northwest side (Side 1, 2) and on the East side (Side #3). During the night Officer Wilcox observed light and what appeared to be a TV on through the Side #4, "B" Window. Officer Wilcox stated that the night was calm and there was a near full moon that occasionally broke through the cloud cover. Officer Wilcox heard what appeared to be the ██████████ walking around inside the residence. The ██████████ was not seen. Wilcox stated if the ██████████ attempted to talk to the officers during the night he would have been able to hear the ██████████. Nearly the entire time his team was deployed around the residence, Night Vision Goggles were used to clearly see the residence. At approximately 0500 hours, the lights and the TV were turned off and no light or movement was seen inside.

From 0300 to 0700 hours, Officer Wilcox and the EPD team did not have any contact with the ██████████. There were no shots fired, negotiations were not attempted and gas was not deployed. Between 0700-0800 HCSO tactical team redeployed around the residence and relieved EPD SWAT. EPD SWAT team responded back to the command post where they rested.

At 0900 hours, HCSO attempted negotiations with the ██████████ without any response. At that time it was determined that GAS was going to be deployed into the residence. HCSO requested EPD SWAT to assist with the GAS deployment. HCSO was going to administer GAS into the #4 side. EPD SWAT was requested to also administer GAS if necessary. The teams were ready to deploy when they received a stand down order, because the command post wanted a Medical helicopter flown in for rapid transport if necessary. During that time negotiations were ongoing. HCSO negotiators used the Police Car's Public Announcement system. The Negotiators used loud and clear commands to ██████████ in attempt to get him to give up.

The HCSO team then deployed one volley of GAS into the #4 side. After that Volley The Command Post determined that GAS deployment was also needed on the #2 side. Deputies that were on the #2 side, observed the ██████████ in the #2 side window. The EPD SWAT team was then given the assignment to deploy GAS into the #2 side. Their orders were to deploy 5 volleys of GAS using the 37mm launcher and evaluate its

effectiveness. The team moved to a position that was approximately 81 yards to the North of the #2 side. That was the closest position of cover on the #2 side. EPD Officers' Jones and Altic were given the assignment of deploying GAS via the 37mm gas launcher. Officer Jones chose the rounds that were going to be deployed into the #2 side. Jones and Altic deployed rounds into the residence. There was no visible effect that the GAS was showing from the #2 side. As GAS was being deployed, Officer Wilcox heard a couple loud "thumps" coming from inside. He did not know what could be making that sound. He thought [REDACTED] might be closing doors.

During the deployment of GAS on both the #4 and #2 sides, Officer Wilcox could clearly hear the negotiator from HCSO. Wilcox was approximately 150-200 yards away from where the negotiators were giving their orders. Wilcox could not hear any sounds coming from inside the residence. It was his impression that a reasonable person could have heard the commands / orders that HCSO was giving throughout the incident.

The Command Post then advised EPD SWAT to attempt to deploy GAS into the #3 side. Officer Wilcox and his team then moved to the #3 side. Officer Wilcox took a position and observed the #3 side approximately 70 yards away. He did not see or hear [REDACTED] inside the residence. Officer Wilcox and his team were in constant watch on the #2 and #3 sides. If the [REDACTED] attempted to surrender their team was in a position to take him into custody.

Officer Wilcox and his team held on the #2 and #3 sides because HCSO was going to deploy hand canisters into the #4 sides. Officer Wilcox heard over the radio that HCSO was going to deploy continuous discharge chemical agent canisters. Officer Wilcox observed slight amount of white cloud when the first hand canisters were deployed into the residence. In the second deployment, Officer Wilcox observed a larger white cloud exiting the #3 side (A) window and over the #4 side roofline. Along with the cloud, Officer Wilcox smelled the distinct chemical agent odor drifting toward him. The smell was strong enough that Officer Wilcox and his team had to deploy their gas masks. After a few minutes, the cloud dissipated. After approximately 5-10 minutes, officer Wilcox observed a slight amount of dark smoke rising up from the #4 side. Soon after he heard a person state on the radio, "Fire." He then heard, "There is smoke in the house, there may be a fire." At that point he heard the HCSO negotiator get on the PA system and advise [REDACTED] that the house was on fire and that he needed to exit the building. His team observed smoke start from the #4 side and over the course of 30 minutes the smoke turned into fire. The fire was concentrated on the South side and it worked North through the residence. After 45 minutes the house was fully involved with Smoke / Fire to the point that the no one could survive. Officer Wilcox and his team held their positions the entire time in case [REDACTED] surrendered or needed to be rescued from the residence. Officer Wilcox did not hear or see any movement coming from inside the residence during the fire. The only sounds they heard were the sounds of ammunition "cooking off" (exploding) during the fire.

After approximately 45 minutes, HCSO called in the fire engines to suppress the fire. When the fire trucks moved in, the stand down order was given to the perimeter officers. Officer Wilcox and his team then responded back to the command post where they were checked out by the investigation team.

Officer Wilcox did not shoot his weapon during the incident. Officer Wilcox only observed the EPD SWAT team deploy gas with a 37mm launcher on the #2 side.

Disposition: Supplemental report referred to HCSO.

1
2
3
4
5
6
7 **INTERVIEW WITH TODD WILCOX**

8 Q=B Honsal

9 Q1=Officer (Bart Silvers)

10 A=Officer Todd Wilcox

11
12
13 Q: June at 2pm at 1400 hours. We're at EPD Interview Room uh- talking with
14 uh, Officer Todd Wilcox. Um, Officer (Bart Silvers) is also present. Uh, can
15 you spell your last name Officer Wilcox for the record.

16
17 A: W-I-L-C-O-X.

18
19 Q: Okay. And uh-uh, we're here to discuss the incident that occurred up at the- in
20 the Hoopa Valley. Um, the incident occurred on June 3rd. Can you tell us how
21 you were notified about that incident?

22
23 A: Yes. I can look at my pager and give you the exact time. I recall it was...

24
25 Q: Okay.

26
27 A: After 8pm. And according to my pager it was at 2019 hours on the 3rd.

28
29 Q: Okay.

30
31 A: Received a page saying to call Sergeant (Nova). Um, details on a call out. So,
32 I did that. I called him at home.

33
34 Q: So you were at home at the time?

35
36 A: Yes, I'm sorry. I was off duty at home when I got the page.

37
38 Q: Okay.

39
40 A: And the notification was to call his residence phone.

41
42 Q: Okay.

43
44 A: Specifically. It gave the phone number. So, I called that number and when he
45 answered it he was actually on the line with Lieutenant (Zinotti) briefing the

46 Lieutenant. And it worked out well because he didn't have a hold feature so I
47 got to hear his conversation with the Lieutenant. At least his half of it- as he
48 was explaining the scenario. And what I gleamed from that was that there had
49 been uh, a [REDACTED] in a residence not his own up in the Hoopa area. He- let's
50 see- I think the resident- C-E- the people who lived there...

51
52 Q: Uh-hmm.

53
54 A: Left the residence and called- I guess it would have been Hoopa Tribal to
55 come remove the [REDACTED] and when they did so, they were fired upon by the
56 [REDACTED]. Uh, the S.O. also responded. I think he said they were also fired on.
57 And they had activated their- I don't know if they call it a SWAT team or
58 CERT team but their Critical Response uh, functionary there at the S.O..

59
60 Q: Uh-hmm.

61
62 A: Went out there and then notified our command that they were going to request
63 a relief. He told me to be at the station ready to go at about 0030 hours.

64
65 Q: Okay.

66
67 A: And...

68
69 Q: So, what does that mean- being ready to go?

70
71 A: Uh, that would mean being in full uniform, any gear that I would want to have
72 in the truck and uh, ready to drive out the back with whatever I think I would
73 need for that sort of an operation.

74
75 Q: Okay. Good deal.

76
77 A: He didn't specify- as he usually doesn't um, any particular weaponry or things
78 like that.

79
80 Q: Okay. So, you loaded up all the um- you and your team loaded up all the
81 necessary SWAT type equipment into your SWAT vehicle.

82
83 A: Uh-hmm. Yes.

84
85 Q: And then you- what time did you guys end up leaving.

86
87 A: We left right around 12:30.

88
89 Q: Prior to leaving, did you as a SWAT team have a briefing? Official briefing?

90

91 A: Hmm. I think- and I don't think we did here. Uh, I remember I had a
92 conversation with (Bill). He said that we would uh, caravan up to the scene...
93

94 Q: Uh-hmm.

95

96 A: Because uh, Lieutenant (Cavinta) and their command staff were already of
97 course there with their command post set up. And that we would get briefed
98 further uh, you know...
99

100 A2: I guess you could say the conversation on the phone really wasn't a briefing.
101 It was more as informational.
102

103 Q: Okay. Gotcha.

104

105 A: But our expectation was that when we arrived he and I at least uh, would get
106 briefed by them and then we would brief our people.
107

108 Q: Okay. So, what time did you- approximately what time did you arrive up at
109 the scene?
110

111 A: Right around two- 0230

112

113 Q: Okay. So, 0230 you arrived um, off of Bloody Camp Road and [REDACTED]
114 [REDACTED] Road.
115

116 A: Yes.

117

118 Q: For the residence.

119

120 A: Actually, I shouldn't say yes. I have no idea what those streets were called.
121 With looking at the diagram, this diagram appears to represent the area we
122 were in.
123

124 Q: Okay. Great. So, 0230 you arrive there and tell us what happened when you
125 arrived.
126

127 A: Uh, when we arrived uh, we got- we started getting our gear on- whatever we
128 didn't already have on at that point. Whether it was you know- some guys
129 didn't wear their vests up there. Their low grain vests just because it's more
130 comfortable for a long car ride.
131

132 Q: Uh-hmm.

133

- 134 A: Get your helmet on. Make sure your stuffs all together. That sort of stuff. Um,
135 radio checks to make sure everyone's on the right frequency. The little odds
136 and ends you do uh...
- 137
- 138 Q: Okay.
- 139
- 140 A: And then Sergeant (Nova) and myself and (Rigo) uh, went into the S.O.'s
141 command post...
- 142
- 143 Q: Uh-hmm.
- 144
- 145 A: Motor home thing. Uh, and spoke with Lieutenant (Cavinta) and I guess he's a
146 Sergeant um, (Quinell).
- 147
- 148 Q: Yes. Okay.
- 149
- 150 A: Um, and they told us that we were dealing with a [REDACTED] that had a history of
151 [REDACTED]. He had been [REDACTED]. While
152 there he committed Felony vandalism on the facility. He was taken by
153 Sergeant (Armstrong) to jail here at Humboldt County's Correctional Facility.
154 My understanding was that while he was there, the jail decided he needed to
155 [REDACTED]. Uh, or be better placed there- better handled as a [REDACTED]
156 [REDACTED]. And then he was subsequently either uh, released from
157 [REDACTED]. I don't honestly remember which. But in any
158 case, he was in neither facility at some point.
- 159
- 160 Q: Okay.
- 161
- 162 A: And then he went to this residence and the connection I understood between
163 him and the residence was previously the Sheriff's Office had- either Sheriff's
164 or Tribal- I thought he had said Sheriff's had arrested him- he escaped while
165 in handcuffs, went to this residence and um, they cut off the handcuffs. So, he
166 had a connection with uh...
- 167
- 168 Q: Okay.
- 169
- 170 A: Some sort with the people that lived there.
- 171
- 172 Q: Okay.
- 173
- 174 A: I later- much later learned that his residence was somewhere on that same hill.
175 I don't know where. At that time, the information I had was that was his only
176 connection with those folks. He was acquainted with them.
- 177
- 178 Q: Okay.

- 179
180 A: That he had arrived and immediately started acting very strangely. I guess
181 bizarrely or whatever was their...
182
- 183 Q: Uh-hmm.
184
- 185 A: To the extent that they their best recourse or course of action was to leave and
186 call for assistance. Um, Hoopa Tribal was called, arrived, fired on and then a
187 deputy arrived- I thought (Cavinta) said. His vehicle was also fired on.
188 (Unintelligible). And as far as I knew, nobody uh- nobody had been hit. Um,
189 I...
190
- 191 Q: So, at that point you said that they were fired upon. Was it discussed who
192 fired at the vehicle?
193
- 194 A: It was always the generic "He". My presumption was and what I heard was
195 that it was the same...
196
- 197 Q1: What I understood- that's a good point you bring that up. But there was
198 mention made that when "somebody" arrived- as soon as they arrived, the
199 individual- whomever- however they identified him was outside the residence
200 and as soon as somebody got there he started sticking knives and other stuff
201 into his belt and into his socks and like down his boots or whatever he was
202 wearing on his feet. Um, just acting very disconnected from reality and then
203 went into the residence.
204
- 205 Q: Gotcha. Okay.
206
- 207 A: So, yeah. That's a good point because that's- that's why I believe there had
208 been an individual there who had been acting bizarrely who then went into the
209 residence and had not been seen to leave yet.
210
- 211 Q: Okay. Okay. So, you got the briefing on what happened.
212
- 213 A: Uh-hmm.
214
- 215 Q: Now, did you get a specific um, person. Was there a [REDACTED] you were looking
216 for? Did- was there a description of that person?
217
- 218 A: Yes. Actually, before we left here. Um, actually when I first the Sergeant at
219 home, he already had a name. Uh, [REDACTED] - I want to say ([REDACTED])
220
- 221 Q: Uh-hmm.
222
- 223 A: But I don't want to swear to that.

224
225 Q: Okay.
226
227 A: And by the time we got to the station they had already pulled up either a- their
228 booking photograph or a DL photograph or something. So, we had a color
229 picture with um, physical descriptors, name. Uh, before we left here and also I
230 got a um, I don't want to say an operational plan but Sergeant (Hoag) had
231 already prepared um, some assignments as far as our personnel went. As far as
232 our mission was um, who our contacts were- an 8'5x11 summary of the
233 incident.
234
235 Q: Okay.
236
237 A: Including the [REDACTED] identification.
238
239 Q: So you had a description of the [REDACTED]
240
241 A: Yep.
242
243 Q: That um...
244
245 A: Well, we had that before we left.
246
247 Q: Yeah. So, can you describe that to me- what you were initially looking at as
248 far as descriptors go?
249
250 A: I think it was an Indian male. I can't remember his age but I want to say in his
251 20's.
252
253 Q: Okay.
254
255 A: I'm thinking ah man- I want to say 5'8. We can't really remember.
256
257 Q: You can speak in generalities. Was it obese, slender?
258
259 A: No, I think he was moderate to slim.
260
261 Q: Okay.
262
263 A: He wasn't described as being obese or being overly muscular or athletic or
264 something like that.
265
266 Q: Okay.
267
268 A: I'd say average to thin.

269
270 Q: Okay. So, getting back to your deployment here. Um, you were inside the
271 Command Post with (Cavinta), (Rigo), (Nova) and (Quinell)?
272
273 A: Uh-hmm.
274
275 Q: At that point did you uh, receive orders for your SWAT team?
276
277 A: We did. Um, part of that being the rules of engagement.
278
279 Q: Okay.
280
281 A: Which were that um, pretty much standard use of force policy. If he presented
282 a threat to us or anybody else uh, that we felt required us to use deadly force
283 to stop that threat or you know, take a life um, that would be in accordance
284 with- with just our regular Department Policy. There was no extenuating
285 circumstances that were there. Um, there was about a 99 percent certainty that
286 there was no one else in the residence but they weren't absolutely positive.
287 Um, he was definitely not a shoot on fight kind of- nothing...
288
289 Q: There wasn't a...
290
291 A: Out of the ordinary like that.
292
293 Q: You see a target you shoot at it?
294
295 A: Nope.
296
297 Q: If the threat...
298
299 A: Like it was explicitly not such that that cause it- it- you know- he said if you
300 see somebody walking around the inside of the residence- just walking around
301 the inside of the residence, do not shoot him or her. Um, there's- there was
302 just no reason to do that.
303
304 Q: Right. Okay.
305
306 A: However, if he came to a window and pointed a weapon or appeared to be
307 acquiring a target or anything else that would lead us to believe he presented a
308 deadly force threat to somebody then um, if that's what we had to do- that's
309 what we would do.
310
311 Q: That's in accordance with your use of force policy?
312
313 A: Yes.

- 314
315 Q: So, nothing would have changed as far as you know- you're going off your
316 standard policy?
317
318 A: Yes.
319
320 Q: And your rules of engagement?
321
322 A: Uh-hmm.
323
324 Q: Okay. So um, you discuss rules of engagement and then um, did you discuss
325 the mission for PPD SWAT at that point?
326
327 A: Yes. We were given the three locations that their teams were at present. One
328 of which would have been around the Hoopa Valley Tribal SUV's on what's
329 noted as [REDACTED] something...
330
331 Q: [REDACTED].
332
333 A: [REDACTED] Road. There was a group of uh, S.O. personnel there. There
334 was another group of S.O. personnel covering pretty much the three side that's
335 noted on this diagram and another group um, closer to the- or with- which I
336 understood had a visual on the one and two sides. We were to- our people
337 were to replace them. We made the determination that we would put two
338 people on the one-two position and two people on the three position and the
339 remaining four on the uh, travel vehicles. That's what we were going to start
340 with and see what we had from there. Our mission was to contain. Um, to
341 engage if necessary a deadly force threat. You know, prevent escape. Observe,
342 gather information. Um, I can't think of any specifics.
343
344 Q: Uh, were you there to relieve anyone?
345
346 A: Yes, we were- that was our function. I mean, that's why we were requested.
347
348 Q: Okay.
349
350 A: Because- was to relieve the S.O. SWAT team- as I understood it- in it's
351 entirety.
352
353 Q: Okay.
354
355 A: Um, cause they'd been there for quite some time and were anticipating having
356 to work the following day. So, we were there to give them a break.
57
358 Q: Okay.

359
360 Q1: Were the locations where you deployed your men any different than where the
361 S.O. was on your arrival?
362
363 A: Not initially. Um, they went to where they were. Our guys went to where their
364 guys were.
365
366 Q1: Okay.
367
368 A: Um, we did have uh- what changed during the- or say the- by about 5:30-6:00,
369 we started to get just a little bit of dawn coming up so we determined all of
370 our locations weren't going to work. And we needed- I know the one that was
371 covering the one-two side were by a pickup I think- a vehicle of some sort-
372 um, so they backed it up further. Because it was fine at night, but they weren't
373 comfortable with that kind of position in the daylight. So they moved- the
374 guys that were covering. Um, (Rigo) and (Altick) were on the number three
375 side um, my understanding is that they backed up prior to day break. Um, the
376 SUV was me, (Johnson), (Tilla), (Jones). And by about daybreak um, the
377 problem we had was we could see the building just fine um, but we were
378 unable to see what was inside the room- particularly through the windows
379 marked A on the number four side. There could have been someone very
380 easily been someone standing just a foot or two inside that window and we
381 wouldn't be able to see them. And we were not at all comfortable with just
382 standing there in the line of fire. So, right around daybreak, I pulled
383 everybody back from that position to the S.O. vehicles and I don't know-
384 spent a half an hour, maybe 45 minutes trying to figure out how we were
385 going to watch that side- without being in the line of fire. And...
386
387 Q: Sorry. Can I interrupt for just a second?
388
389 A: Sure.
390
391 Q: Going back to initial deployment.
392
393 A: Uh-hmm.
394
395 Q: Um, what was your role as far as um-uh, what is your current role on the
396 SWAT team and was that role what you full filled out there at the-at the
397 scene?
398
399 A: My current role is Team Leader. And my role on this particular page in was
400 Team Leader.
401
402 Q: Okay. So, you were in charge of how many SWAT members?
403

- 404 A: Uh, let's see. Oh, seven. Eight including myself. But there was seven I was
405 supposed to be in control of and I was the one who decided who was going to
406 go where.
407
- 408 Q: Okay.
409
- 410 A: With (Bill)'s concurrence.
411
- 412 Q: Right. So, you deployed your guys. Where were you positioned initially?
413
- 414 A: I was at the front of the SUV nearest the number four side.
415
- 416 Q: Okay. Can you go ahead and mark that with number one? Okay- okay, and so
417 you um, then monitored the number four side from that position?
418
- 419 A: Yeah. During the night um, there's three and there's a three- bout to scale.
420
- 421 Q: Uh-hmm.
422
- 423 A: Uh, there's two trees along the way towards the building. Sergeant (Johnson)
424 and myself moved up to the nearest tree uh, and again- as daylight came up on
425 us um, we backed all the way up to the vehicle.
426
- 427 Q: Okay. Um, based on your observations- did you see anything at the residence-
428 did you make any [REDACTED] contacts um, during the night time hours when you
429 were in that position?
430
- 431 A: Made no [REDACTED] contacts. Um, I didn't see anybody. I heard what sounded
432 like motion. Someone walking around or thudding sounds of footsteps. Not-
433 nothing being thrown around or anything like that but just noises you might
434 expect sitting outside a house. Um, somebody walking around inside. I believe
435 the TV was on based on the flickering light which was that bluish bright light
436 like you get from a TV at night.
437
- 438 Q: Can you tell on this drawing where the TV was coming- or was on in- or the
439 light or the window you were using to...
440
- 441 A: Sure. Window A was dark.
442
- 443 Q: Okay.
444
- 445 A: All night. Or I should say the room inside of window A. I didn't see any
446 artificial light inside that room ever.
447
- 448 Q: Okay.

449
450 A: Or that appeared- that appeared to come from that room. Window B on the
451 four side was pretty brightly illuminated until maybe five or so when it was
452 shut down.
453
454 Q: Was it- was it consistent with what you thought-saw the light as being
455 electrical light at that point? Candle light?
456
457 A: I would say electrical light.
458
459 Q: TV?
460
461 A: And TV. Um, there was the bluish flickering light like the TV and there was
462 also what appeared to be um, a steady bright fluorescent type light- not a
463 flickering from the fire place or a candle light. Or- I mean, I suppose it could
464 have been oil lamp- those don't flicker.
465
466 Q: Uh-hmm. Okay. So, then um-
467
468 A: Oh, you asked where the TV was.
469
470 Q: Uh-hmm. Yes.
471
472 A: I think it was in room B.
473
474 Q: Okay.
475
476 A: Just because it seemed- when it- every once in a while especially with the
477 night vision it would get much brighter very brief like a very bright
478 commercial would come on and it was brightest in room B. But you could see
479 sort of a light bouncing around or something into room- or in window A.
480
481 Q: So- what you saw- you always had someone with night vision goggles looking
482 at the number four side?
483
484 A: As close to always as you can get.
485
486 Q: Okay.
487
488 A: I wouldn't say one hundred- I would say 99.9 percent of the time. Every once
489 in a while- whoever was tasked with that would take them away from their
490 eyes for a second but never more than, you know...
491
492 Q: Okay.
493

- 494 A: Never more than 10 seconds.
495
- 496 Q: And again just-just repeating. There wasn't- it wasn't dead quiet uh, inside the
497 residence? You heard the sounds of creaks, you heard the sound of someone
498 walking inside.
499
- 500 A: Yeah. Not anything extraordinary.
501
- 502 Q: But...
503
- 504 A: Apart from the hour- it was the middle of the night, but yeah. It was um,
505 generally quiet-ish. There was music playing I think. Well, not I think. There
506 was music- but I don't know if he was watching MTV or if he had a radio
507 going or some other music device.
508
- 509 Q: So, you heard music coming from...
510
- 511 A: Heard music.
512
- 513 Q: Now, was it loud enough that you couldn't hear voice coming from inside if
514 someone wanted to talk? Or was it...
515
- 516 A: No- no, you could have talked over it. Particularly if you had been anywhere
517 near that window.
518
- 519 Q: Uh-hmm.
520
- 521 A: Up window A, there was two panes- the left hand pane had a couple holes in
522 it.
523
- 524 Q: Okay.
525
- 526 A: The right hand pane was in tact. It appeared to have maybe a bullet impact. I
527 don't know if we later decided that that wind- that pane was plexy glass or
528 something but that would make sense because it looked like a bullet impact
529 but the window wasn't broken. On the right hand pane- window A.
530
- 531 Q: Okay. So, in this general area, can you describe the lighting? Um, during uh,
532 the time you got deployed?
533
- 534 A: Um, like as it was- it was a fairly bright moon but it was overcast. So, you
535 know, it was by no means pitch dark but it wasn't also an extremely bright-
536 brightly lit moonlit night.
537
- 538 Q: Okay. So um, night vision goggles were needed?

539
540 A: Absolutely. All you could see from this position without night vision was the
541 glow coming from window B.
542
543 Q: Okay. Uh, at some point did you change your position? From the number one
544 position?
545
546 A: Um, well first thing- during the hours of darkness, like I said- Sergeant
547 (Johnson) and I went up to this nearest tree.
548
549 Q: Could you mark that as number two? And you moved up there to what?
550
551 A: To get closer. So we could see better.
552
553 Q: Okay.
554
555 A: Like um...
556
557 Q: If someone wanted to give up um, could you have heard them from that
558 distance?
559
560 A: Oh, definitely.
561
562 Q: Okay.
563
564 A: Yeah, that was another advantage of being closer was we felt like we could
565 hear what he was doing inside better and likewise if somebody had made any
566 kind of verbalizations to us. I feel confident we would have heard it.
567
568 Q: Okay. Uh, when day broke um, your position was compromised by daylight at
569 number two. Where did you move to?
570
571 A: First we moved back to the first SUV.
572
573 Q: Okay. As number three. Okay.
574
575 A: And I was going to say shortly after that- very shortly after that...
576
577 Q: Okay.
578
579 A: We realized we were in a very bad position there.
580
581 Q: Okay.
582
583 A: And we extracted back to these cars which um, were not in the line of sight.

584
585 Q: Okay. So, you could not see the house at that point?
586
587 A: You could not and that- we were in that position for half an hour.
588
589 Q: Okay.
590
591 A: Something like that.
592
593 Q: Was there anyone seeing the front of number four?
594
595 A: I don't believe at that point we had eyes on side four.
596
597 Q: From your distance could you have heard someone that wanted to give up in
598 that position? Or was there someone in position on number three and number
599 four side that could have- if someone stuck their head out the window...
600
601 A: If someone stuck their head out the window and yelled- I'm pretty confident- I
602 don't know, but I'm pretty confident that people on the number three side
603 would have heard it. I'm not sure about where they ended up. On number one-
604 two side how far away they were.
605
606 Q: Could you see the officers on the number three side?
607
608 A: No where.
609
610 Q: Okay. Could you just mark on this drawing here with the letter A where you
611 deployed your other teams around this building?
612
613 A: As I understand it, A went up- excuse me. "A" would be- right around there
614 would be the initial diagram.
615
616 Q: Okay.
617
618 A: But I said I was working up a diagram that the S.O. had of where their people
619 were...
620
621 Q: Right.
622
623 A: And my understanding was to be like that...
624
625 Q: Okay. Good.
626
627 A: Okay.
628

629 Q: Great. So, then you moved back to this position. And do you know what time
630 it was by the time you moved back to that position? Or how long after day
631 break or?
632

633 A: No, I don't.
634

635 Q: Okay.
636

637 A: I could guess six-ish.
638

639 Q: Okay. And um, at some point did your position change or did your mission
640 change when you moved back to that point?
641

642 A: Uh, our mission did not change. Uh, we moved back to this position here. To
643 the rear of the second SUV because um, we pulled out because we felt we
644 were like sitting ducks where we were...
645

646 Q: Okay.
647

648 A: And we went back because I just couldn't take it anymore. Um, I-I felt like
649 there had to be a way to get eyes on that side.
650

651 Q: Okay.
652

653 A: And I just felt like that was my job and...
654

655 Q: Uh-hmm.
656

657 A: So, after staring at those two vehicles I-I went up there to see if there was a
658 way to crawl underneath them or do something with some degree of safety get
659 on eyes on that thing and when I got back here I- from this back- the
660 passenger rear corner- the way the vehicle was angled, I could just poke my
661 head around it and I could see with binoculars into window A far enough that
662 I felt like I was reasonable confident there wasn't somebody standing in that
663 room pointing a gun at us.
664

665 Q: Okay.
666

667 A: That would have had a shot without me seeing them first.
668

669 Q: Okay.
670

671 A: And then Officer (Jones) came up and the two of us kept eyes on it um, quite a
672 while.
673

674 Q: Good. At that point, at that position, did you hear anything coming from
675 inside the house? Any music? Any sounds? Anything like that?
676

677 A: Hmm- man. I don't think so. That was after he'd set up. Who ever was
678 inside...
679

680 Q: Uh-hmm.
681

682 A: Uh, shut everything down at about five. I don't remember hearing anything
683 after that until we got back into position later- later in the day.
684

685 Q: Okay. So, five o'clock everything appeared to shut down?
686

687 A: Or-or thereabouts, yeah.
688

689 Q: Okay. So, something, someone had to shut things off. Lights, the TV...
690

691 A: Yes.
692

693 Q: Okay. Um-uh, so your mission was number four. Was there sometime at that
694 point that you were relieved uh, from-from um, your perimeter position?
695

696 A: Yes. A group of...
697

698 Q: Do you remember what time it was? And then who relieved you? Or
699 approximately.
700

701 A: Let's see. Guessing the time will be tough. I want to say- it could be anywhere
702 between about seven- eight.
703

704 Q: Okay.
705

706 A: Maybe in that range in the morning.
707

708 Q: Okay. You were relieved by whom?
709

710 A: I don't know.
711

712 Q: Uh...
713

714 A: Several- they were Sheriff's Office personnel.
715

716 Q: Sheriff's Office. Okay.
17

718 A: But um, unfortunately I don't know most of them by name.

719
720 Q: No, no problem.
721
722 A: Some of them I don't even know by sight.
723
724 Q: Okay. So, guys in different uniforms from the Sheriff's Office came up and
725 relieved you?
726
727 A: Yeah.
728
729 Q: Okay.
730
731 A: It was daylight, they took up position guarding number four.
732
733 Q: Uh-hmm. And uh- as Team Leader, were there any shots fired by your team
734 while you were guarding number four?
735
736 A: No.
737
738 Q: Okay. Um, was there any gas deployed on that side?
739
740 A: No.
741
742 Q: Okay. You then uh- after you were relieved by the S.O. personnel- where did
743 you go?
744
745 A: Went back to the Command Center area type here by the...
746
747 Q: Uh-hmm.
748
749 A: The- what is known as the TOC- T-O-C on the diagram.
750
751 Q: Okay.
752
753 A: Um, I think (Bill) briefed me that they're- the Sheriff's Office intention was to
754 continue to try and give orders- surrender orders to him.
755
756 Q: Uh-hmm.
757
758 A: To continue to try and get some kind of communication going of some sort.
759 And that we were to take a break and that once we were done taking a break
760 or whenever the situation dictated um, we'd go back to assist (unintelligible).
761
762 Q: Uh-hmm.
763

764 A: So personally, I went and sat in the driver's seat of the truck and passed out.
765 Cause I'd been up for like 26 hours at that point. No- but 24 hours definitely.
766 And then was awakened by- I think it was (Rigo). Um, oh- it must have been
767 nine maybe. So, I think I got a couple hours of sleep so we must have broke
768 about seven cause it was about nine that we got up. Cause we got all suited up,
769 went down- the whole team um- all of us went- cause everybody had been
770 pulled off. All PPD guys got pulled off at once and were replaced. Not
771 simultaneously but you know, a few people from the Sheriff's Office went out
772 to the position covering A, relieved the guys that were there. Some guys went
773 to the positioning- excuse me- side three. The one-two guys got relieved by
774 another group of people, but eventually we all got posse up together at the
775 PPD truck. Took a break, got unbroke...

776
777 Q: Uh-hmm.

778
779 A: Suited again and then our mission was to go to the patrol vehicles- have a
780 little (unintelligible) with (Quinnell) because um, they were talking at that point
781 about deploying chemical agents. So, we were there to assist as far as they
782 were going to put in a volley into side four and if there was a problem or a
783 necessity we were to be prepared to also to put in a volley in side four. Um,
784 our function as I understood it was a backup. We were just going to stand by
785 till they asked us to do something.

786
787 Q: Okay. So yeah- so now your going to change your cat tactics from sitting on
788 the residence to deploying gas into the number four side and your mission was
789 to back them up with whatever be necessary to them they have?

790
791 A: Yes.

792
793 Q: Okay.

794
795 A: And we were waiting on that because they wanted to have a helicopter- a
796 Medivac- a medical type evacuation helicopter in place before we did that. So,
797 we got into position and then stood down for maybe an hour in position while
798 we were waiting for the helicopter and stuff to get coordinated.

799
800 Q: Hmm.

801
802 A: And all the while- or I should say intermittently they were giving verbal
803 commands. And then they'd wait maybe 15 minutes and then do it again for
804 maybe two or three minutes. Take a break.

805
806 Q: When you say verbal commands um, do you know how those verbal
807 commands were given and what they were said?
808

809 A: Uh, they were initiated by hitting the siren one of the SUV's. I don't...Are we
810 good?
811

812 Q: We're good.
813

814 Q1: Sorry about that.
815

816 A: No, there was maybe a car length at most in between the two SUV's. So, if
817 they were in the second one, it wasn't that much further back. But they would
818 burp the siren a few times, and then get on the PA, the vehicle's PA. And um,
819 say something like ([REDACTED] this is the Sheriff's Office, come out. We need you
820 to put down any weapons that you have. We need you to come out the front
821 door with your hands in plain view. Uh, we want to help you. We can't help
822 you while you're still inside. Uh, we can't do anything for you while you're in
823 there, so you need to come out. And no harm will come to you, we just need
824 you to come outside so we can help you.
825

826 Q: Uh-hmm.
827

828 A: So, that was the kind of thing that was repeated. Um, like I said, they would
829 do it, take a break, come back do it some more, take a break...
830

831 Q: In your knowledge um, do you think that that PA system- um, you heard it
832 from the distance that you were away from the S.O. cars or the Hoopa Valley
833 Tribal cars...
834

835 A: Uh-hmm.
836

837 Q: Uh, do you believe it was loud enough to be heard in the trailer?
838

839 A: I do now because of where I was later on.
840

841 Q: Okay. Good. We'll get back to that later on. So uh, at that point did your
842 mission get- change from being a back up behind the Sheriff's Office on the
843 south side?
844

845 A: Yeah. After- I'm thinking- what I'm thinking is I know that they put one
846 volley of chemical agents into the four side and I can't remember if they did a
847 second volley while we were there or not. I think they did. And then it was
848 decided- they continued in between to-to verbalizations. Um, (unintelligible).
849

850 Q: No problem.
851

852 A: Uh, let's see.
853

854 Q: Hold on a second. We'll take a break. We'll change sides here. Here we go.
855 Side two. 1430, go ahead.
856

857 A: Okay. So after either one or two volleys of chemical agents went into the four
858 side by the S.O.'s team um, their command decided- who ever was in charge
859 decided our mission would become to get into position where we could deploy
860 chemical agents into the number two side. And I believe that was based on-
861 yeah. I- it was- before we got there, whoever from the Sheriff's Office got
862 eyes on the number two- number two side and the door on the number one
863 said that he saw somebody inside the window on the number two side.
864

865 Q: Okay.
866

867 A: So, we had reason to believe that there was somebody moving around. I
868 thought he said he was on the ground flailing around or rolling around or
869 doing something so um, that was when we decided that- somebody decided
870 that- I think Command decided that we needed to get around to that side since
871 they'd- the idea was to gain access to the house in increments. And hopefully
872 to convince him to go out the front door. There was also a door on the number
873 three side. Bout two thirds of the way from the four to the two. So we had two
874 door ways he could go through.
875

876 Q: Okay.
877

878 A: In addition to a large window on the number two side. Uh...

879

880 Q: Were those doors being blocked by anything that you guys were doing?
881

882 A: Uh, no.
883

884 Q: Okay.
885

886 A: No- I mean the number three- no. I mean we weren't...
887

888 Q: Anywhere close?
889

890 A: Anywhere from doing that and hopefully he couldn't even see us.
891

892 Q: Uh-hmm.
893

894 A: That would have been the idea.
895

896 Q: Right. So then um, you- you uh, made mention that there's one or two volleys
897 that went into number four side by the S.O.- chemical agents.
898

899 A: Uh-hmm.
900
901 Q: Then the information changed- they want you to go over to the number two
902 side because someone last saw the [REDACTED] on the number two- two one
903 corner?
904
905 A: In- inside the...
906
907 Q: Inside the room.
908
909 A: The window on the number two side is about in the middle of this thing.
910
911 Q: Okay.
912
913 A: And that's presumably the window they were talking about. Cause there's
914 only one window and it was my understanding- I think it was (Bishop) that
915 was over here. Um, that was covering that number two-number one door.
916 Number two side, number one door. And it was through that window that he
917 could see somebody so that's when the decision was made to send us up and
918 around the hill and come down the other side.
919
920 Q: Uh-hmm.
921
922 A: And um, we ended up over here. Do you want that marked?
923
924 Q: Yes. Yeah. How about number- number six I guess now.
925
926 A: Okay. So, number six ended up being the nearest good spot for deploying
927 chemical agents on- into that window.
928
929 Q: And the approximate distance between that window and your position?
930
931 A: Uh, laser range we have with this I think called it 81 yards.
932
933 Q: Okay, 81 yards. So, it shows 81 yards because why? Why would...
934
935 A: That was the closest available cover?
936
937 Q: Okay.
938
939 A: If we had any (unintelligible) we would have never shot from that far.
940
941 Q: Right.
42

943 A: Not because it was a safety risk for him or anyone else. It was simply
944 operational efficiency for the weapon system- not weapon- yeah- deployment
945 system- not really a weapon.
946

947 Q: Uh-hmm.
948

949 A: Intended to be a weapon. A chemical deployment system is not at it's best at
950 81 yards. Where it's most accurate- in addition to that, the rounds are not
951 going to be the most effective from that difference.
952

953 Q: So, you're north of the number two side approximately 81 yards? Um, and
954 you are set up to deploy gas into that room?
955

956 A: Yes.
957

958 Q: Okay. Who- who did you put in charge or who was put in charge of- of
959 shooting the chemical agents into that room?
960

961 A: Uh, (Jones) and (Altick) were the ones who actually did the deployment. I was
962 with them.
963

964 Q: Okay, you were with them.
965

966 A: Right. They were selected. (Jones)- between the two of them, they selected the
967 rounds to use.
968

969 Q: Okay.
970

971 A: Exact ammunition- that was their choice.
972

973 Q: Gotcha. So they- they chose. How long after you're initially in that position
974 did you start um, the volley of gas? And who directed that volley?
975

976 A: Oh goodness. We got the word- we told Command we were in position. Um,
977 they gave us the order to commence when ready. We told them we were going
978 to begin just before we began and then uh, once they started I left that to
979 (Jones) and (Altick). Oh, we- we were- the direction that was given was to put
980 five rounds into the room, wait and if there were a second volley, to be
981 prepared for a second volley- five rounds. Um, and in between those two
982 volleys, there were the verbalizations again from the- it sounded like it was
983 coming from the same place- the Hoopa Valley SUV's.
984

985 Q: Okay, so there was an announcement being made. Now, you are 81 yards
86 away from number two side window?
987

988 A: Uh-hmm.
989
990 Q: And then they are approximately how far away from the number four side?
991
992 A: I think that was ranged at about 65 yards. And there was a hill in between us.
993 This is not by any means low ground.
994
995 Q: Okay.
996
997 A: So you know...
998
999 Q: The sounds coming over a hill and then...
1000
1001 A: Around a corner...
1002
1003 Q: Around a corner and through the trailer to you. And a total distance damn
1004 close to maybe 200 yards.
1005
1006 A: As the crow flies. Yeah.
1007
1008 Q: As the crow flies.
1009
1010 A: Yeah, it wasn't a straight shot. There was trees and other stuff.
1011
1012 Q: At the distance of um, what we estimate about 200 yards could you clearly
1013 hear the PA being announced?
1014
1015 A: Yeah, I could tell what he was saying.
1016
1017 Q: And you could tell what he was saying. Were the orders clear and concise?
1018
1019 A: Yeah. It was the repeat of the same thing before- you know, you need to come
1020 out of the house, you need to not have anything in your hands. You need to...
1021
1022 Q: Did you hear any music being played inside the house at that time? Did you
1023 hear anything that could be distracting the person that's inside?
1024
1025 A: I didn't hear anything from inside.
1026
1027 Q: Okay. Were there any- were the windows in the number two- was that open?
1028 Or was that closed?
1029
1030 A: I should correct myself. Throughout the time I was in that position- it's not
1031 true to say I did not hear anything from inside. I heard a couple of thumps.
1032

1033 Q: Okay.
1034
1035 A: During the time that I was in that position. I did not hear any music. I did not
1036 hear what I thought was television- anything of that kind of sound. But I did- I
1037 do recall hearing one or two- I think two different times I heard a thump. Not
1038 a loud thump, just a thump.
1039
1040 Q: What do you attribute that thump to? What would you?
1041
1042 A: I don't know. I mean...
1043
1044 Q: You just...
1045
1046 A: Never being around that residence before I don't have a point of reference.
1047 Maybe a closing door?
1048
1049 Q: Okay.
1050
1051 A: I-I really don't know.
1052
1053 Q: Okay. Okay. So then um, you initially- they-they pump some gas into the
1054 house.
1055
1056 A: Yes.
1057
1058 Q: Now, how- when they- when they volley the gas did they break the window?
1059 Did they go through the window?
1060
1061 A: The rounds? My understanding- or what I saw was the round that hit the
1062 window broke the window.
1063
1064 Q: Okay. And then did you see any of the uh, chemical agents disseminate in the
1065 room. Did you see it being...
1066
1067 A: You don't.
1068
1069 Q: You don't see it.
1070
1071 A: I didn't and I wouldn't.
1072
1073 Q: Okay. Um, so- but there's now a clear hole in the windows.
1074
1075 A: Uh-hmm.

- 1077 Q: Once the window hole is opened- did you hear anything? Did you hear any
1078 screaming? Did you hear anyone in pain? Did you hear anyone- anyone's
1079 voice at all coming from inside?
1080
- 1081 A: No.
1082
- 1083 Q: Okay. Um, if someone came to that window and shouted for help- wanted to
1084 give up...
1085
- 1086 A: Would have seen them.
1087
- 1088 Q: Could you have seen them and heard them?
1089
- 1090 A: Yeah.
1091
- 1092 Q: Okay. Um, so volleys of gas were initiated? Now, were there also volleys of
1093 gas being initiated on the number four side by the S.O. at the same time?
1094
- 1095 A: Not at the same time. We- trying to think of the exact. I can't- I'm trying to
1096 think of the exact sequence. I know we put in on the number two side. They
1097 put in on the number four side. And I think we put our second volley in
1098 number two and they put a second into number four while we were in that
1099 position.
1100
- 1101 Q: Okay.
1102
- 1103 A: And in between that there was still the commands being given.
1104
- 1105 Q: Commands being given. Okay. Um, did you at any time start seeing um, the
1106 chemical agent start pouring out the windows as far any kind of a smoke? Any
1107 indication that- that the gas was filling the house?
1108
- 1109 A: No.
1110
- 1111 Q: Okay. Um...
1112
- 1113 A: And actually what was being put in wasn't gas per se. It's a particular um,
1114 they may have a liquid as well but um, there's just a single little- once the
1115 thing hits it breaks hopefully and disperses that chemical agent in the room.
1116
- 1117 Q: Chemical agent.
1118
- 1119 A: Yeah.
1120
- 1121 Q: Like a liquid.

1122
1123 A: A liquid or powder. We're powder.
1124
1125 Q: Gotcha.
1126
1127 A: And it's not like you're going to see. If you're in the room and you put two or
1128 three canisters in there and there's some air circulating you'll see- you know,
1129 what looks like um- looks like dust floating in the air.
1130
1131 Q: Okay. Um, did you position change from the number six position uh, at all.
1132 From that point on?
1133
1134 A: Yes. We moved- we moved over to where- close to where the people were
1135 already covering the three side because we were instructed to move to the
1136 number three side to try to put chemical agents in from that position.
1137
1138 Q: Okay. So, your team- your chemical agent team moved from number six and
1139 can you draw- write in number seven where you- where you moved.
1140
1141 A: I personally think that's probably about here.
1142
1143 Q: Uh-hmm.
1144
1145 A: And then the chemical agent guys were sort of in between.
1146
1147 Q: Okay. At that point can you draw the windows and- and any openings that
1148 were in there?
1149
1150 A: Windows- yeah. A two pane window here but this side was covered with ply
1151 wood.
1152
1153 Q: Hmm. Okay.
1154
1155 A: And there was the door here. It looked like opened out.
1156
1157 Q: Okay. So, at that point, was there gas uh, deployed from that side?
1158
1159 A: Yes. They put- I don't know the numbers. They put- if we call this the A
1160 window and I think that's what you referred to it.
1161
1162 Q: Yes, uh-huh.
1163
1164 A: They put chemical agents through the A window and the B window.
1165

1166 Q: Okay. So, agents were in. During that time, did you see any movement on the
1167 inside? Was there any [REDACTED] in there?
1168

1169 A: I never saw.
1170

1171 Q: Or anyone- any voices? Anything like that heard?
1172

1173 A: Voices? Um, I can't remember now if we heard any motion at that point.
1174 Honestly, I can't remember.
1175

1176 Q: Okay. So then um, did your mission change at all from that number seven or
1177 did anything force your position to change at that point?
1178

1179 Q1: Okay- thanks (Ron).
1180

1181 A: Uh, we never moved.
1182

1183 Q: Okay.
1184

1185 A: From there until um, the fire department came in. This is where we were.
1186

1187 Q: Okay.
1188

1189 A: Our mission after the point of those two volleys- or those deploying gas-or
1190 chemical agents into those two openings was to contain. Um...
1191

1192 Q: So, your position is to deliver the gas and also contain the perimeter? You're
1193 to cover the number three side?
1194

1195 A: Uh-hmm.
1196

1197 Q: Uh, if someone would have stuck their head out the window or out of one of
1198 these openings- A, B, or the door, could you- were you in position to take that
1199 person into custody? To assist that person into surrendering?
1200

1201 A: Certainly.
1202

1203 Q: Okay.
1204

1205 A: Um, you know I was probably 70 yards away. I had a very clear view of the
1206 number two door and of this window. I had binoculars that I was watching it
1207 with. There were three people that were positioned over here that had a better
1208 view or had a view.
1209

1210 Q: Uh-hmm.

1211
1212 A: See- I couldn't see this A window.
1213
1214 Q: Now, at this A-B opening on the number three side- were those open? Were
1215 they broke open by the chemical agents?
1216
1217 A: I don't- I could never see the A window.
1218
1219 Q: Okay.
1220
1221 A: I could see a bit of the frame to know where it was. I don't know it's status. B
1222 window had a hole in it from a chemical agents but it was otherwise intact.
1223 Um, and it was hard to see through. I don't know if there was- I don't know
1224 what was on the inside of it. It wasn't curtains but it was almost like it was
1225 fogged.
1226
1227 Q: Okay.
1228
1229 A: Like a bathroom window but um...
1230
1231 Q: Kind of frosted then?
1232
1233 A: Yeah. Kind of- don't know what the problem with it was but I couldn't see
1234 through it. And I never saw- you know it wasn't like I could see somebody
1235 move past it inside even a shadow. Um, but had somebody stuck their head
1236 out there you know, we would have heard them- we would have seen them. If
1237 someone had come out that door, I personally would have seen them
1238 definitely cause I was watching it.
1239
1240 Q: Um, at some point um-uh, did you see anything that uh, became alarming to
1241 you?
1242
1243 A: Uh, sometime down the road.
1244
1245 Q: Okay.
1246
1247 A: Um...
1248
1249 Q: Can you estimate how long after your volleys of gas- did you see something?
1250
1251 A: Yes- that was a while. I mean, I'm thinking- you lose track of time when
1252 you're- I'm thinking an hour- two hours maybe. I mean, it was a while.
1253
1254 Q: Okay.
1255

1256 A: Because be in the intervening time was when this S.O. team made two
1257 different approaches to the house to deploy chemical agents up close and
1258 personal.
1259

1260 Q: Okay.

1261

1262 A: Um, so there was a lengthy amount of time there.
1263

1264 Q: So, you were to hold your position at the number three side. Your sole mission
1265 now was to do was a hand deployment of- of chemical agents into the number
1266 four side?
1267

1268 A: Yeah. I should correct myself. I don't know how they put it in there.
1269

1270 Q: Okay.

1271

1272 A: From what I heard on the radio was that they were going to have to actually
1273 approach the place- what I heard on the radio was they were going to be
1274 actually using some sort of discharge device which the only thing we have
1275 like that uh, you pretty much have to toss in by hand.
1276

1277 Q: Okay.

1278

1279 A: Um, it's not something you can fire at the structure as you could with the
1280 37mm round. So, I guess I'm assuming what they were actually going to do
1281 was walk up to it and lob by hand the devices through the uh- and they said on
1282 the radio that they put something through the A opening and B opening on the
1283 number four side.
1284

1285 Q: When they- could you tell um, you heard the radio. You didn't see the
1286 deployment. But could you tell based on your observation post once the
1287 chemical agents uh were initiated into the residence? Could you see anything?
1288

1289 A: After the first one I could see a little bit of what appeared to be uh, smoke that
1290 I would associate with deployment of some sort of continuous discharge
1291 device coming from the four end of the house.
1292

1293 Q: Okay.

1294

1295 A: Cause I couldn't see the windows on the four side. But coming up over the
1296 roof line I could see some sort of a smoke like looking...
1297

1298 Q: Okay.

1299

1300 A: Small cloud.

1301
1302 Q: Gotcha.
1303
1304 A: And then they repeated that. The second time- I don't know what they put in
1305 the second time but it- there was a lot more smoke um, and I was- like I said I
1306 was about 70 yards up the hill from it and it- as soon as I saw the smoke and I
1307 could smell it and- it couldn't have been 10 seconds from seeing it I could
1308 smell it and then it started burning my eyes. Maybe another 10 seconds after
1309 that and I had to put my mask on.
1310
1311 Q: So, what you were smelling at that point was chemical agent.
1312
1313 A: Yeah.
1314
1315 Q: You weren't smelling three smell of um, of-of burning type smell like you
1316 would with plastic or wood or what not.
1317
1318 A: No. My- my understanding was that that second deployment by hand they
1319 were using a chemical agent that is combined with smoke. The smoke
1320 particles are to carry the chemical agent around. And that had to contaminate
1321 the house. Cause that was a lot of agent. I mean I shouldn't say a lot of agent,
1322 but it did a really good job of contaminating me from 70 yards away so um...
1323
1324 Q: So that- you saw smoke was filling the house at that point?
1325
1326 A: I could not see smoke filling the house.
1327
1328 Q: Okay. So...
1329
1330 A: Based on the amount that was coming out the windows and how bad I was
1331 getting affected by it from 70 yards away I believe the house was all
1332 contaminated.
1333
1334 Q: Okay. Um, and at that point did you see that particular agent dissipate?
1335
1336 A: Yeah. After I got my mask on, it was another maybe minute or so and the air
1337 pretty well cleared.
1338
1339 Q: Okay. Um, did they deploy anything else after that? Did anyone deploy
1340 anything to the best of your knowledge?
1341
1342 A: Not after that.
1343
1344 Q: Okay.
1345

1346 A: Just those two times that I can recall.
1347
1348 Q: Um, what else did you see at that point? Is there anything else that occurred?
1349
1350 A: After that um, I noticed a different color of smoke or what appeared to be
1351 smoke coming from that side.
1352
1353 Q: Can you reference an approximate time after everything cleared up to the
1354 point where you started seeing smoke again?
1355
1356 A: Maybe a minute- you know on the order of.
1357
1358 Q: Okay.
1359
1360 A: Um, maybe five minutes.
1361
1362 Q: Okay.
1363
1364 A: You know I wouldn't say half an hour.
1365
1366 Q: Okay.
1367
1368 A: And I wouldn't say two or three minutes. I wouldn't even say 15. So, five to
1369 10 maybe in that bracket is when I first- and there was a good breeze going so
1370 it was just gently lofting out.
1371
1372 Q: So then um, there was a different kind of smoke?
1373
1374 A: There was a different color.
1375
1376 Q: Color- what was that color?
1377
1378 A: It was darker.
1379
1380 Q: Darker color.
1381
1382 A: I wouldn't say it was thick black smoke but it was definitely darker, grayish,
1383 brownish- not like the white that had come out before.
1384
1385 Q: The continuous discharge chemical release was a white smoke?
1386
1387 A: Yeah.
1388

1389 Q: And then this smoke was a kind of a darker brownish, grayish- at that point
1390 did anybody say anything? did you hear anything on the radio? Did you hear
1391 any PA announcements? Anything like that?
1392

1393 A: First thing I recall was- I don't know if he said his identifier or not but I heard
1394 a voice that I believe was Sergeant (Nova)'s voice say Fire.
1395

1396 Q: Okay.
1397

1398 A: And then there was some more radio traffic about smoke from the house. It
1399 appears there may be a fire inside. And very shortly there after um, heard the
1400 verbalizations from generally the SUV are- I was now over a pretty good hill.
1401

1402 Q: Uh-hmm.
1403

1404 A: From them- but I could hear very clearly saying we see smoke, we're
1405 concerned there may be a fire [REDACTED], you need to get out of the house
1406 immediately. You know, get out of the house. There's no reason to stay in the
1407 house. Come out the door. Um, you know, we're concerned that there may be
1408 a fire in your house.
1409

1410 Q: So, at that point could you see um, through number three A window?
1411

1412 A: Couldn't see the window.
1413

1414 Q: Couldn't see the window.
1415

1416 A: Where I was there was a visual obstruction.
1417

1418 Q: Okay. Could you see the residence at all?
1419

1420 A: Oh, yeah. I could see from about midway from A and B down to the two-three
1421 corner.
1422

1423 Q: Could you see smoke pouring out of anything out of the three side that you
1424 could see?
1425

1426 A: Not-
1427

1428 Q: Or the two?
1429

1430 A: Not initially. Not coming out of any of the openings, no.
1431

32 Q: Okay. Um, to the best of your knowledge someone could have come out to
1433 that opening and surrendered a that point?

- 1434
1435 A: Oh, yeah. I think- to my knowledge yeah.
1436
1437 Q: There wasn't- this wasn't fully involved?
1438
1439 A: Oh, no. No, but when we first saw the smoke come out- my opinion would be-
1440 being an expert as it is- uh, it was not fully involved. There was no smoke
1441 coming out- initially there was no smoke coming out of the chimney which
1442 was about here.
1443
1444 Q: Okay.
1445
1446 A: Um, when they put the continuous discharge chemical agents in there, smoke
1447 initially just lofted up over the edge of the eaves- so out the A-B windows on
1448 the number four side and it was within maybe 15 seconds- 30 seconds before
1449 it even came out the chimney.
1450
1451 Q: Okay.
1452
1453 A: And then when the- what I presume was the fire started- again, smoke came
1454 lofting up over the eaves and then a few minutes later- what seemed like a few
1455 minutes later uh, smoke started trickling out the chimney. But there were a
1456 number of other vents further down the roof line and there was no smoke
1457 coming out of them.
1458
1459 Q: Okay.
1460
1461 A: Not for quite a while.
1462
1463 Q: Now, were you set up to- if someone wanted to give up- to rescue someone or
1464 to take someone into custody on that side?
1465
1466 A: Certainly. If someone had come out either of these openings um, we would
1467 have given them commands to you know, halt, show their hands, that sort of
1468 things and because the- what appeared to be a fire also appeared to be
1469 contained to the number four side, I wouldn't have any problem coming down
1470 the hill and getting them to move or giving them commands to come around to
1471 the safer area over here. There was a gravel road they could have been
1472 directed to had they been led to comply.
1473
1474 Q: Uh, to your knowledge based on your observation of the number three side
1475 um, how long were you there and uh, before number three side was fully
1476 engulfed in flames?
1477
1478 A: Uh, a long time. I'd say fully engulfed probably 45 minutes.

1479
1480 Q: Okay.
1481
1482 A: It-it- I was watching the B side window trying- so I could call out once we
1483 thought the fire had progressed that far. It was forever and a day before there
1484 was even any smoke seeping out the B window and then finally out around the
1485 door. It had to be 30 to 45 minutes.
1486
1487 Q: Gotcha. And-and the B window on the three side- that was still closed to...
1488
1489 A: Closed but ported.
1490
1491 Q: Okay.
1492
1493 A: At least one good sized hole from the 37.
1494
1495 Q: Gotcha. Okay. And then um, at-at what point did you um, then uh, de-mobe
1496 here?
1497
1498 A: Uh, once the fire was left and during the time we're watching it while it was
1499 burning you could hear what sounded like rounds going off inside the house.
1500
1501 Q: Okay.
1502
1503 A: Um, I don't know. I couldn't give you a good reason why. Our presumption
1504 was that it was just being cooked off and not being fired at us.
1505
1506 Q: Okay.
1507
1508 A: Um, and then eventually fire was brought up along here and I could see the
1509 trucks come in at that point. And once they started fighting the fire with the
1510 Sheriff's Office providing cover for them uh, even prior to that, we backed up
1511 a bit because the smoke was getting so thick and we really don't serve a
1512 purpose, and we really don't have breathing apparatus.
1513
1514 Q: Right.
1515
1516 A: For our safety, it was better to back up.
1517
1518 Q: From your position. Okay.
1519
1520 A: Um, and then once- oh, I think we must have got a radio command at some
1521 point to go ahead and secure and come back down the hill to the Command
1522 Post.
1523

- 1524 Q: Okay. And that's where you were checked out there and um, geared down and
1525 then talked with investigators?
1526
- 1527 A: Uh-hmm.
1528
- 1529 Q: Okay. Um, I believe that's it. Anything else? You have anything else to add
1530 Todd that would aide in the investigation at all?
1531
- 1532 A: Uh, just that it took a very long time for this thing to get burning. And I felt
1533 like- as much as none of us- you know, wanted to see it start on fire...
1534
- 1535 Q: Uh-hmm.
1536
- 1537 A: The nice thing you could call it was that it- it unexpectedly- it took a long time
1538 to get involved and I felt very time that at any time somebody was going to
1539 come jumping out the number two window or that back door because he- if
1540 someone was inside wanted to tough it out- at some point they were going to
1541 decide that that wasn't going got work and they would have had an
1542 opportunity. It wasn't as if I saw smoke and immediately poof- into flames.
1543
- 1544 Q: Uh-hmm.
1545
- 1546 A: It wasn't like that at all. It took a long time and I was really surprised that uh,
1547 somebody didn't come out.
1548
- 1549 Q: Did you see anything as far as a change in the fire? Did it ever accelerate
1550 rapidly or did it ever...
1551
- 1552 A: No-no.
1553
- 1554 Q: Did it ever fizz out.
1555
- 1556 A: It just gently started coming out more places further down. It was coming out
1557 the vent, then it was coming out the eaves, then it was coming out the top and
1558 pretty soon you could see flames coming out this end- and it just pretty
1559 gradually would swing out. I would say the fire- cause it was a trailer.
1560
- 1561 Q: Uh-hmm.
1562
- 1563 A: Very flame retardant or something.
1564
- 1565 Q: Something.
1566

1567 A: For a manufactured home I was impressed how long it took that thing. If you
1568 were asleep somewhere and a smoke detector went off, you'd have plenty of
1569 time to get out of that house.

1570
1571 Q: Yeah, that's a good point. Did you hear anything going off?

1572
1573 A: Huh-uh.

1574
1575 Q: Okay. All right. The interview is going to be concluded. It is uh, 1455.

1576
1577
1578 This transcript has been reviewed with the audio recording submitted and it is an accurate
1579 transcription.

1580 Signed _____

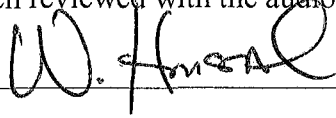
A handwritten signature in black ink, appearing to read "W. Honsal", is written over a horizontal line that serves as a signature line.



HUMBOLDT COUNTY DISTRICT ATTORNEY'S OFFICE INVESTIGATION REPORT

DATE: July 6, 2007
CASE: HCSO #200703162

Witnesses: [REDACTED]
D. Higgerson, Sergeant, California Department of Corrections
A. Dornback, Sergeant, California Department of Corrections
D. Barneburg Sergeant, California Department of Corrections

DA Investigator: William Honsal

On June 13th, 2007 at 1130 hours, Eureka Police Department Detective Kevin Lawson interviewed D. Higgerson, A. Dornback, and D. Barneburg. The interview was conducted at CDC Pelican Bay and was recorded on cassette. For a detailed statement refer to attached transcript.

Higgerson, Dornback, and Barneburg stated that they attempted negotiations from approximately 0900 to 0945 hours. They utilized a bullhorn and a Public Address (PA) system from a patrol vehicle on site on the Southside of the residence. No contact was made with the [REDACTED]. During that time nothing was seen and no information was gathered. At 0945 hours, the negotiators responded to the Command Post where they stood by until the incident concluded at 1700 hours.

Each negotiator wrote a report detailing their involvement in the incident. Refer to the attached reports for details.

Disposition: Supplemental report referred to HCSO.

Memorandum

Date : June 7, 2007

To : Humboldt County District Attorneys Office

From : Department of Corrections and Rehabilitation
Pelican Bay State Prison, P.O. Box 7000, Crescent City, CA 95532-7000

██████ : **MUTUAL AID TO HOOPA VALLEY INCIDENT**

Per your request, this memorandum documents my involvement in the barricaded ██████ incident which occurred in Hoopa, California on June 3rd and 4th, 2007.

I am currently a member of the Pelican Bay State Prison (PBSP) Crisis Response Team (CRT), Negotiations Element. On June 3, 2007 I was contacted via telephone at my residence by Negotiations Leader D. Higginson who advised me of a request for mutual aid from the Humboldt County Sheriff's Office (HSO) due to a barricaded ██████ in Hoopa. I responded to the institution at approximately 0300 hours on the morning of June 4th, 2007, where the Negotiations Element loaded out equipment and responded to McKinleyville, California. Upon arrival we received an incident briefing from HSO Lieutenant D. Morey at the McKinleyville station at approximately 0600 hours.

The Negotiations Element arrived at the incident site at approximately 0740 hours where we received a more detailed briefing from HSO personnel. Negotiator T. Dornback was assigned as the Primary Negotiator and I was assigned as the Secondary Negotiator. During the course of the incident, I was armed with the following state issued equipment; a .38 caliber Smith and Wesson revolver, eighteen (18) rounds of hollow point ammunition, an expandable baton, and an MK-3 Oleoresin Capsicum (OC) dispenser.

At approximately 0855 hours, Negotiator Dornback and I approached the house with members of the PBSP CRT Tactical Element. From our vantage point, I observed a blue and green single story structure. Unidentified on site HSO tactical personnel informed Negotiator Dornback and I that the ██████ was barricaded within the residence. Negotiator Dornback and I attempted to make contact with the ██████ via bullhorn and the Public Address System (PA) of a Tribal Police vehicle at the site. Attempts to contact ██████ were unsuccessful and Negotiator Dornback and I retreated from the site with our tactical escort at approximately 0940 hours.

During the remainder of the incident, I assisted with gathering intelligence and providing perimeter security. From my vantage point at the entrance to the driveway, I was unable to observe any tactics utilized or munitions deployed during the course of the incident. At approximately 1500 hours, smoke was visible rising over the hilltop from the incident site.

At approximately 1700 hours, I was informed by the PBSP Negotiations Leader that the ██████ ██████ had been discovered deceased in the residence. The PBSP CRT team was

released by the HSO at approximately 1700 hours. This concluded my involvement in this incident.

A handwritten signature in black ink, appearing to read 'D. Barneburg', written in a cursive style.

D. BARNEBURG

Negotiator

Crisis Response Team

Pelican Bay State Prison

Memorandum

Date : June 7, 2007

To : District Attorneys Office
Humboldt County

From : Department of Corrections and rehabilitation
Pelican Bay State Prison, P.O. Box 7000, Crescent City, CA 95532-7000

██████████ MUTUAL AID TO HOOPA VALLEY INCIDENT

Per your request, this memorandum is being submitted regarding my involvement in the Barricaded ██████████ Active Shooter incident which occurred during June 3rd and 4th, 2007 in Hoopa, California.

On June 3, 2007 at approximately 2100 hours, I was contacted at my residence by Lieutenant (Lt.) D. Morey, regarding an active shooter in the Hoopa Valley area. Lt. Morey requested Mutual Aid from Pelican Bay State Prison (PBSP), Crisis Response Team (CRT). I called Lt. D. Kays, Watch Commander, notifying him of the request. He advised me that he would ask Administrator of the Day (AOD) M. D. Yax for approval. At approximately 2145 hours, Lt. Kays notified me that we had approval for Mutual Aid. I notified Lt. Morey of our approval; he requested we arrive at the McKinleyville Sheriffs station at 0600 hours on June 4, 2007. I notified CRT Commander J. Ricker and the rest of the PBSP Negotiations team of the call out for Mutual Aid.

PBSP Negotiations Team, CRT and three Tactical Operators arrived at McKinleyville Sheriffs station at 0600 hours and received a briefing from Lt. Morey. We followed Lt. Morey to the incident site arriving at approximately 0740 hours. I assigned Team positions as noted below:

- A. Dornback – Primary Negotiator
- D. Barneburg – Secondary Negotiator
- R. Mazyck – Negotiations Operator
- A. Harrison – Negotiations Operator
- R. Berry – Negotiations Communication Liaison
- F. Vanderhoofven – Negotiations Operator

I was armed with a .38 revolver, expandable baton, MK-3 Oleoresin Capsicum and radio. We were debriefed as to the barricaded ██████████ ██████████ and the progress of their negotiations with the ██████████. I advised A. Dornback and D. Barneburg to attempt a face-to-face negotiation escorted by 3 Pelican Bay Tactical Members. At approximately 0855, the attempt to negotiate was initiated. They continued their efforts for approximately 45 minutes with negative contact. For the remainder of the incident I gathered intelligence and

Mutual Aid to Hoopa Valley Incident
June 7, 2007
Page 2

provided security. I was located in the proximity of the Command Center and was unable to see the incident site.

At approximately 1700 hours, I was notified by Negotiator R. Berry of the [REDACTED] being found deceased in the residence. Our Team was released at approximately 1700 hours by the HSO.

This ends my involvement in the incident.



D. HIGGERSON
Negotiations Leader
Crisis Response Team
Pelican Bay State Prison

Memorandum

Date : June 7, 2007

To : Humboldt County District Attorneys Office

From : Department of Corrections
Pelican Bay State Prison, P.O. Box 7000, Crescent City, CA 95532-7000

██████████ MUTUAL AID TO HOOPA VALLEY INCIDENT

On June 3, 2007 at approximately 2200 hours I was contacted by our Team Leader (Sergeant Del Higgerson) of the Negotiations Element of our Crisis Response Team. I was advised that our team was being activated for mutual aid to assist Humboldt Sheriffs Office (HSO) with a barricaded ██████████ in Hoopa Valley, California. Our team was instructed to meet with Lieutenant David Morey of HSO in McKinleyville, California at approximately 0600 hours on June 4, 2007.

At about 0600 hours on June 4, 2007, our team met with Lieutenant Morey at the Sheriffs Sub Station in McKinleyville. Lieutenant Morey escorted our team to the incident location arriving on scene at about 0730 hours. Soon after arriving, our team was given a briefing of the situation by the on scene Incident Commander. I was assigned to the position of Primary Negotiator and was outfitted with following equipment; 38 caliber revolver, expandable baton and MK3 Oleoresin Capsicum canister.

At about 0850 hours, D. Barneburg (assigned as Secondary) and I approached the incident site with three Tactical Operators from our Crises Response Team in an effort to establish communications with the ██████████ (██████████). The three Tactical Operators that provided escort were; A. Navarro, J. Lawrence and P. Martinez. Upon approaching the incident site area, we obtained cover and concealment behind ballistic shields and two patrol vehicles. While looking around, I noticed one of the patrol vehicles (I believe the second one in line) had what appeared to be bullet impact areas on the windshield. I also remember looking at the residence and noting how quiet it was. I also noticed that there did not appear to be any movement within the residence.

At approximately 0900 hours, contact was attempted utilizing a bullhorn, with no response from the ██████████. After several minutes, I also attempted contact via one of the patrol cars' public address system in hopes that the louder volume would prove more positive. At approximately 0930 hours, after no response to several attempts to make contact with the ██████████ we left the incident site and returned back to the Command Post. While at the Command Post area, I remained nearby in case a negotiator became necessary. While on standby I provided assistance where needed and reviewed gathered intelligence on the ██████████ and incident.

MUTUAL AID TO HOOPA VALLEY INCIDENT

June 7, 2007

Page 2

At approximately 1115 hours while in the area of the Command Post, I heard communications that chemical agents had been deployed. Later at about 1440 hours I heard via radio that smoke had been observed emanating from within the residence. Shortly after, I saw fire trucks move into position near the incident site. I also noticed smoke rising into the air near the incident site, however from my vantage point I could not see from exactly where.

At approximately 1700 hours after the fire had been extinguished and the incident site secured, HSO released us from the incident and we returned to Pelican Bay State Prison in Crescent City.



A. DORNBACH

Negotiator

Crisis Response Team

Pelican Bay State Prison

Memorandum

Date : June 7, 2007

To : District Attorney
County of Humboldt

From : Department of Corrections and Rehabilitation
Pelican Bay State Prison, P.O. Box 7000, Crescent City, CA 95532-7000

MUTUAL AID TO HOOPA VALLEY INCIDENT

On June 3, 2007, I was activated via pager as a Crisis Negotiator. My pager instructed me to report to Pelican Bay State Prison (PBSP) at 0300 hours. Upon arrival I assisted in loading equipment and received a briefing concerning the incident. After loading our equipment we traveled to McKinleyville to meet Lt. D. Morey at the Humboldt County Sheriff's Office (HCSO) substation.

At approximately 0600 hours, Lt. Morey provided an additional briefing and instructed us to follow him to the incident site. We arrived at the incident site at approximately 0740 hours. Upon arrival to the incident site I was assigned to assemble equipment and prepare situation boards for a negotiations operation center. I was armed with a Smith & Wesson .38 revolver with 2 speedloaders, a set of handcuffs, an MK3 Oleoresin Capsicum canister, and an expandable baton.

I was directed to set up the situation boards within a small box trailer located at the left side of the entrance to the residence driveway. There was a dark crew cab truck located at the right side of the driveway entrance. The Command Center vehicle was parked on the driveway a short distance from the driveway entrance. I assisted in placing yellow caution tape extending from the dark crew cab truck to the box trailer. During the majority of the incident I was located within the immediate area of the command center vehicle.

During the incident I maintained a position so that I could view the roadway leading to the residence driveway and provide security for the Command Center. From this position I was not able to observe the incident site. After the incident was concluded I was able to approach the incident site and observed the remains of the burned residence.

I was directed to stay a safe distance from the house and to stay clear of areas where potential evidence may be located, specifically; the area where the patrol vehicles had been located but were removed to allow access for the fire suppression vehicles. After briefly viewing the incident site I assisted other PBSP staff in collecting our equipment and returning to the institution.

F. C. VANDERHOOFVEN
Negotiator
Crisis Response Team
Pelican Bay State Prison

Memorandum

Date: June 7, 2007

To: District Attorneys Office
Humboldt County

From: Department of Correction and Rehabilitation
Pelican Bay State Prison, P. O. Box 7000, Crescent City, CA 95532-7000

██████████ **MUTUAL AID TO HOOPA VALLEY INCIDENT**

Per your request, this memorandum is being submitted regarding the barricaded ██████████ active shooter situation which occurred in Hoopa, California on June 3 & 4, 2007. I am currently assigned as a Negotiator on the Pelican Bay State Prison (PBSP) Crisis Response Team (CRT).

On June 3rd, at approximately 2130 hours I was contacted by pager regarding an active shooter/barricaded ██████████ in the Hoopa Valley. The CRT Negotiations Element was instructed to meet Lieutenant D. Morey at the Humboldt County Sheriff's Office in McKinleyville at 0600 hours for instructions; We followed Lt. Morey to the command post located in Hoopa Valley and were briefed about the progress of the negotiations. After the briefing, Pelican Bay Negotiators D. Barneburg and A. Dornback were escorted by Pelican Bay Tactical Operators to the crisis site to attempt negotiations at 0849 hours. After attempting for 40 minutes to make contact with the ██████████ (██████████), They received no response. After the attempt at negotiations, I acted as perimeter security as well as being on standby should negotiations become necessary.

I acted as a Negotiations Operator, conducting interviews of the family and members of the community. I was armed with a state issued 38. Caliber revolver, expandable baton, MK-3 Oleoresin Capsicum dispenser, handcuffs and a radio. I was stationed at the command post site. Due to my location during the incident, I was unable to see any of the tactics utilized to attempt and bring the ██████████ out of the residence.

A. HARRISON
Negotiator
Crisis Response Team
Pelican Bay State Prison

Memorandum

Date : June 07, 2007

To : District Attorneys Office
Humboldt County

From : Department of Corrections and Rehabilitation
Pelican Bay State Prison, P.O. Box 7000, Crescent City, CA 95532-7000

██████████ **MUTUAL AID TO HOOPA VALLEY INCIDENT**

Per your request this memorandum is being submitted regarding the barricaded ██████████ active shooter situation which occurred in Hoopa Ca., on June 3rd and 4th. I am currently assigned as a Negotiator on the Pelican Bay State Prison (PBSP) Crisis Response Team (CRT).

I received a call out page at approximately 2200 hours telling us to respond at 0300 for response to McKinleyville, for an Active Shooter/ Barricaded ██████████ Mutual Aid. We left Pelican Bay State Prison at approximately 0430 with all of our equipment. I was armed with a 38 cal. Revolver with 18 rounds of hollow point ammunition, and an expandable baton. We arrived in McKinleyville at approximately 0600 hours, and received a briefing from Lt. D. Morey, of the Humboldt County Sheriffs Office. We left McKinleyville and left for Hoopa at approximately 0620 hours. Upon our arrival to the scene at approximately 0740 hours, we were briefed on the situation, and prepared to begin negotiations. At approximately 0845 hours, Negotiators A. Dornback and D. Barneburg attempted to make contact with the ██████████ via a bullhorn and public address system, with no response. They continued to attempt to make contact for approximately 40 minutes.

I was then assigned as the communications liaison between Humboldt County Sheriffs Office and the Pelican Bay State Prison Crisis Response Team. I remained in the Command Post for the duration of the incident, periodically exiting the Command Post to gather and pass information between departments. I was unable to see the incident site from the Command Post, and therefore did not see any actions taken by the tactical Teams. Upon conclusion of the incident, our team was dismissed from service by the Humboldt County Sheriffs Office, and returned to Pelican Bay State Prison.

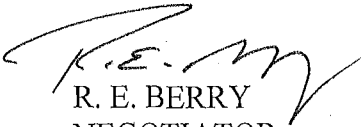
R. E. BERRY
NEGOTIATOR
Crisis Response Team
Pelican Bay State Prison

Memorandum

Date : June 7, 2007

To : District Attorneys Office
Humboldt County

From : Department of Corrections
Pelican Bay State Prison, P.O. Box 7000, Crescent City, CA 95532-7000

██████████ **MUTUAL AID TO HOOPA VALLEY INCIDENT**

Per your request, this memorandum is being submitted regarding the Barricaded ██████████ Active Shooter situation which occurred in Hoopa, California on June 3 & 4, 2007.

On June 3, 2007, at approximately 2200 hours, I was contacted via pager regarding a Barricaded ██████████ Active Shooter holed up in a residence in Hoopa, CA. We were instructed to meet D. Morey, Lieutenant, Humboldt County Sheriffs Office, at the McKinleyville Substation at 0600. We followed Lt. Morey up to the Command Post, where we were debriefed as to the progress of their negotiations. After receiving the information, Negotiators T. Dornback and D. Barneburg, escorted by Pelican Bay Tactical, approached the site to attempt negotiations at approximately 0849. The negotiations continued with negative results for approximately 40 minutes with no response from the ██████████ (██████████). After the attempt at negotiations, we acted as perimeter security as well as being on standby if the ██████████ was to allow negotiations to commence.

I acted as the Secondary to the Negotiations Leader, conducting interviews of the family as well as community members and Mental Health consultants. I was armed with a .38 revolver, expandable baton, MK-3 Oleoresin Capsicum and radio and was deployed to the Command Post site. Due to my location during the incident, I was unable to see any of the tactics utilized to try and bring the ██████████ out of the residence.

R. MAZYCK
Negotiator
Crisis Response Team
Pelican Bay State Prison

1
2
3
4
5
6
7
8
9
10
11
12
13
14
15
16
17
18
19
20
21
22
23
24
25
26
27
28
29
30
31
32
33
34
35
36
37
38
39
40
41
42
43
44
45

INTERVIEW WITH (DAVE) BARNEBURG

Q=William Honsal

A=(Dave) Barneburg

Q: ...police, it's Wednesday the 13th, 1007 at 1220 hours. Also present is (Bill) Honsal from the Humboldt County DA's office. (Unintelligible) interview at Pelican Bay State Prison, uh, in reference to the incident in (Hoopa) on (██████████) Road. Can you go ahead and state your name, spell your last name for us, please?

A: Sure, my name is (Dave) Barneburg, B-A-R-N-E-B-U-R-G.

Q: And how are you currently employed?

A: I'm a correctional sergeant with the Department of Corrections. Uh, I currently work for the institutional gang investigations unit.

Q: And how long have you been employed by CDC?

A: Uh, 10 years.

Q: Ten years. Do you have any other duties as- as- besides being gang sergeant?

A: Uh, I am a member of the crisis response team, negotiations element and I'm a negotiator.

Q: Okay. And how long have you served in that capacity?

A: Uh, almost two years, August would be two years.

Q: Okay. Uh, as you became a crisis negotiator, have you received any specialized training?

A: Uh, we have a- an academy, it used to be a basic and an advanced academy and they merged those a couple years ago. So, uh, it's a two week course. It's considered the basic and advanced academy which I've attended.

Q: And have you ever participated in a live crisis negotiation?

- 46
47 A: Uh, I've been called out for two different incidents. Um, uh, since I've been
48 on the CRT team. One was six or seven months ago at Super 8 incident, we
49 brought equipment down and- and assisted Humboldt County and- and
50 (unintelligible) PD. And, uh, then this incident.
51
- 52 Q: Okay. On June 3rd of this year, uh, did you receive a phone call or any
53 special instructions in reference to a possible call out?
54
- 55 A: I did- I received a call from, uh, (Del Hagerson), he's my negotiations leader.
56 He called me at my home, uh, basically putting us on standby. Um, we had
57 had a request of- of, uh, mutual aid from Humboldt County, uh, Sheriff's
58 office in reference to a barricaded [REDACTED] we had in there, up in Hoopa.
59
- 60 Q: And at some point in time, did you make your way towards Humboldt
61 County?
62
- 63 A: Uh, we got- I got a page, uh, probably a half-hour after that, uh, giving
64 direction to assemble at Pelican Bay at three in the morning, which we did.
65 Uh, loaded our equipment, hit the road and we met, uh, Lieutenant (Dave
66 Morray) from Humboldt County Sheriff's office in McKinleyville, there's a
67 substation at McKinleyville and had a- uh, a briefing from (Dave Morray).
68
- 69 Q: And after that briefing took place, did you eventually go to Hoopa?
70
- 71 A: We did, we followed, uh, Lieutenant (Morray) up to Hoopa, up to the incident,
72 site.
73
- 74 Q: Once you arrived there, uh, could you tell me what your duties were?
75
- 76 A: Uh, I was assigned by, uh, negotiations leader (Hagerson) as a, uh, secondary
77 negotiator, which basically is in support of the primary negotiator which was
78 (Anthony Dormback). Um, we were told that, uh, attempts had been made to
79 contact the [REDACTED] uh, ([REDACTED]) uh, in the residence which was, you
80 know, down the road from where the command center was. Uh, we were told
81 that, uh, shots had been fired at both, uh, I believe Humboldt County Deputies
82 and tribal police. And, uh, there was, uh, information, I think at some point in
83 negotiator had been shot at, but it's unconfirmed. I don't know, it was never
84 confirmed to me. So we were told that, uh, we were- they wanted us to
85 respond up to a site closer to the residence where we could attempt contact
86 and negotiation.
87
- 88 Q: And did you respond up to that site?
89

90 A: I did, with, uh, three members of our tactical team and with (Anthony
91 Dormback).

92

93 Q: Okay, in front of you, you have a map there...

94

95 A: Mm-hm.

96

97 Q: Um, could you mark on that map where it was that you responded to?

98

99 A: Initially, we responded- there were two, um, uh, Expedition-style SUVs,
100 parked, uh, in the road going up to the residence. We initially responsive to
101 the lead vehicle- responded to the lead vehicle, which was, uh, a tribal police
102 vehicle. And we attempted contact with a bullhorn from that, um, that
103 location.

104

105 Q: Af- once you attempted contact with the bullhorn, was there any response
106 from the residence?

107

108 A: No, not at all.

109

110 Q: Okay. And after that, what did you do?

111

112 A: Um; the three (Unintelligible) members, uh, negotiator (Dormback) and I
113 moved back in the second vehicle in line, which was also a SUV, tribal police.
114 And, uh, (Dormback) used the public address system to attempt to contact
115 again from the- from the rear vehicle.

116

117 Q: Okay, if you could mark on that map for me, with the number two...

118

119 A: Mm-hm.

120

121 Q: ...as to the second position you were at.

122

123 A: Okay.

124

125 Q: And after negotiator (Dormback) tried, uh, with the PA system, was there any
126 response from anyone in the residence?

127

128 A: None.

129

130 Q: Could you hear anything going on in side the residence from where you were
131 at?

132

133 A: No, it was extremely quiet, um, from where we were. Um, it was complete
134 silence and we didn't hear anything coming from the residence.

- 135
136 Q: Were you able to see any one or any particular portion of the residence?
137
138 A: Only as we approached, coming up from behind our tactical team, that had
139 their ballistic shields, uh, for cover in front of us. They have a window port in
140 the front of the ballistic shield. So I was able to see through the port as we
141 approached the residence initially, um, you know, briefly, that it sat up on the
142 hill. And then I didn't see it again until after the incident was over.
143
144 Q: Okay. How- how long did you attempt negotiations for- for both times,
145 including the bullhorn and the PA?
146
147 A: We would probably be, uh, attempting to make contact approximately 40, 45
148 minutes.
149
150 Q: Okay. And after that, uh, did you- how long did you remain at those two
151 vehicles?
152
153 A: For the- about 40-45 minutes, while we were trying to make contact.
154
155 Q: Okay. And after that 40 or 45 minutes, did you go somewhere else?
156
157 A: Oh we retreated back to the, uh, command post which was at the, uh, entrance
158 to the, uh, the driveway or Jasper Hospital Road, which comes off of Bloody
159 Camp Road- uh, the mobile command center and I briefed, uh, negotiations
160 leader, (Hageron) on the a- attempted contact and what had transpired.
161
162 Q: Okay. And from that- from that time after the briefing with, uh, Sergeant
163 (Hageron), was there any other time that you went back down to the
164 residence?
165
166 A: Uh, after we were told that, uh, it was clear to go back down to the residence,
167 we- and the fire trucks had already been down there, we walked back down
168 and I wanted to get a look at the incident site and see exactly what we had
169 been dealing with. So...
170
171 Q: So this was- this was after the fire.
172
173 A: Yes.
174
175 Q: Okay. Um, at any time you were, uh, on scene, did you hear any gun-
176 gunshots fired?
177
178 A: Uh, while the fire was active and I was up at the- uh, the entrance to the road,
179 um, you could hear faint pops, but I don't know if that was rounds cooking off

180 inside the residence or, you know, we were down the road and around the
181 corner, so it could have been almost anything.

182
183 Q: At anytime that you were up by the two tribal vehicles, did you hear any
184 rounds going off?

185
186 A: No.

187
188 Q: And- and were you armed with a firearm at that time?

189
190 A: Yes I was.

191
192 Q: Okay, and at no time you discharged your firearm?

193
194 A: No, I did not.

195
196 Q: Oh, okay. All right, how about a chemical agents?

197
198 A: Uh, I just carried a- a mach three OC dispenser and no I didn't discharge that
199 either.

200
201 Q: Okay. (Unintelligible). This will be the end of the interview. It's, uh, 1227.
202 Thanks.

203
204
205 This transcript has been reviewed with the audio recording submitted and it is an accurate
206 transcription.

207 Signed _____

1
2
3
4
5
6
7
8
9
10
11
12
13
14
15
16
17
18
19
20
21
22
23
24
25
26
27
28
29
30
31
32
33
34
35
36
37
38
39
40
41
42
43
44

INTERVIEW WITH (ANTHONY) DORNBAC

Q= Detective (Ronson)

Q1=William Honsal

A= (Anthony) Dornback

Q: This is Detective (Ronson) with (Eureka) Police. It's Wednesday the 13th of June, 2007 at 1140 hours. Doing at interview at the Pelican Bay State Prison. Uh, also present with me is, uh, Bill Honsal from the Humboldt County DA's Office. Could you go ahead and state your name and spell your last name for me please?

A: Yes it's (Anthony) Dornback, D-O-R-N-B-A-C-K.

Q: And you're employed here at the Pelican Bay?

A: Yes.

Q: How long have you been employed?

A: Uh, 17 years, 6 months.

Q: And your duties here?

A: I am a correctional sergeant in charge of, uh, our training division.

Q: And did you have an occasion to participate in, uh, an operation in (Hoopla) in Humboldt County?

A: Yes I did.

Q: Okay. And do you remember roughly when that was?

A: That was on June 3rd.

Q: June 3rd. And if you could go ahead and, uh, outline for me how you were notified and, uh, what your assignment was.

- 45 A: Uh, about 2200 hours, um, I was notified by my, uh, team leader of our
46 negotiations (unintelligible) of the Crisis Response Team that we were put –
47 being put on standby for a possible mutual aid situation for, uh, barricaded
48 [REDACTED] in Humboldt County. My duties at that time were to also notify the
49 rest of our team and ensure that our contact per our calls were followed.
50
- 51 Q: Okay. And, uh, how long have you been involved with the Crisis Response
52 Team?
53
- 54 A: About 10 years.
55
- 56 Q: And what are your duties?
57
- 58 A: I'm a negotiator.
59
- 60 Q: Negotiator. And have they been the same as a negotiator the entire 10 years?
61
- 62 A: Um, we've had a couple different re-structures. Right now all of our
63 negotiators are cross trained to do the same functions. On that particular night
64 I was also advised that I would be the – assigned as the primary negotiator,
65 um, for at least part of the – depending how long the exercise went.
66
- 67 Q: And what type of training do you receive to become a negotiator?
68
- 69 A: Uh, we, um, have a basic and advanced academy. Um, before re-structure of
70 the Crisis Response Team we were also called the Negotiations Management
71 Team and we had basic negotiators course, um, quite a number of years back
72 that, uh, when I first started 10 – about 10 years ago we went through. And
73 then we went through the advanced and the, uh, basic negotiators course. I
74 also helped the academy with their instruction when they put other negotiators
75 through the course.
76
- 77 Q: Okay. And this – this course is this run through CDC?
78
- 79 A: Yes it is.
80
- 81 Q: Okay. Um, if you could estimate for me how many, uh, negotiations you've
82 been involved in.
83
- 84 A: Um, all the negotiations that I've been involved in have been training.
85
- 86 Q: And so on – on this night after receiving orders – a notification to standby
87 were you eventually activated?
88
- 89 A: Yes.

90
91 Q: Okay. And I assume you left from here at Pelican Bay?
92
93 A: Um, we were instructed to rally at, um, at Pelican Bay State Prison at about 3
94 o'clock in the morning.
95
96 Q: And from there where did you travel to?
97
98 A: Uh, we went to McKinleyville to meet up with (Dave Mori) of Humboldt
99 Sheriff's Office.
100
101 Q: Thank you. And how many members of your team went with you?
102
103 A: Um, including myself seven.
104
105 Q: Seven. And after you arrived in McKinleyville and met with Lieutenant
106 (Mori) of the sheriff's department...
107
108 A: Mm-hm.
109
110 Q: ...uh, did you receive a briefing at that time?
111
112 A: We had a briefing.
113
114 Q: Okay. And from there what happened?
115
116 A: Uh, he had us follow him up to the incident site.
117
118 Q: Okay. And do you recall roughly what time you arrived at the incident site?
119
120 A: I would say somewhere around 800, 830.
121
122 Q: Okay. And once you arrived there what happened?
123
124 A: Um, our negotiations team leader (Dill Higgerson), um, myself and another
125 negotiator went to the, uh, incident command post to try to get an updated
126 briefing of all the – the current status of the negotiations and what was
127 happening in the incident.
128
129 Q: And did you receive that briefing?
130
131 A: They did give us some information at the briefing.
132
133 Q: Okay. What – what was the information that you received?
134

- 135 A: The information we received was that, um, prior to us arriving there they had
136 dispatched some officers, uh, to the residence and upon going to the residence,
137 uh, they had contact with the [REDACTED] from a distance. Um, they – well there
138 was an exchange of some gunfire. The officers – deputy at that time retreated
139 to another area and called for additional units and basically set up a perimeter
140 and at that particular time, um, the special units for like Humboldt their spot
141 team and everything started responding to the area.
142
- 143 Q: Was it decided, uh, how these negotiations if – if you were going to engage in
144 negotiations how they were going to take place.
145
- 146 A: Um, the basic idea that was set on out was that we were just gonna try to
147 establish contact. My understanding was that previous attempts through the
148 evening had produced negative results. Um, I never verified but I heard at one
149 point in time that some negotiators that were up there may have, uh, been fired
150 upon at one point in time. Uh, no I can't confirm that.
151
- 152 Q: Were you told if there was, uh, any means of communications inside the
153 house? Was there a phone line? Was there a cell phone available or any of
154 that?
155
- 156 A: They – um, my understanding was, was that, uh, they did some research to try
157 to come up with phone lines and there was no communications inside the
158 residence that were at least reliable.
159
- 160 Q: Okay. And was there a – a plan, uh, for any of the tactical teams to deploy
161 say a throw phone, uh, or any other means of communication into the
162 residence?
163
- 164 A: I think they wanted us to try to establish communication with him first. Um,
165 and we were going to attempt that by, uh, bull horn and see if we could get
166 him interested in communicating and then at that time we would be able to
167 deliver a phone.
168
- 169 Q: Did you ever participate in any dialogue of – of attempting to establish contact
170 with him? Did you ever get on the bull horn or the PA system?
171
- 172 A: Yes.
173
- 174 Q: And do you recall what you said to him?
175
- 176 A: Um, while, uh, myself, (Dave Barnyberg) was a secondary and three of our
177 tactical operators moved towards the scene and, um, I took a bull horn with
178 me and for several minutes, um, I would make an announcement that I was
179 there representing on behalf of the sheriff's office who wanted to make

180 contact with them. Um, we wanted to know that he's okay. Uh, and every
181 time I would, uh, put out a broadcast we would wait a little while for a
182 response.
183

184 Q: Did you ever get a response from him?
185

186 A: No. No. And after several times of trying the bull horn just to make sure that,
187 you know, audibly we could be heard we, um, went to one of the, uh, um,
188 announcements, uh, PA systems on one of the patrol cars and attempted to do
189 the same thing.
190

191 Q: Okay. And at any time you – at – at no time you got a response from him?
192

193 A: No there was never any responses. It was very quiet.
194

195 Q: Could you hea- were you close enough to where you could hear, uh, had there
196 been a response from him that you'd be able to hear him?
197

198 A: I believe so.
199

200 Q: Okay. You have a map there in front of you. Uh, when you were deployed
201 could you write on there for me and mark it with a number one as to where
202 you were positioned? Okay. You've indicated right at the front of the first
203 patrol vehicle.
204

205 A: Yeah. But we – we hunkered down behind the, uh, car door and we also had,
206 uh, ballistic shields. And that's where I was trying to do with bull horn
207 contact.
208

209 Q: Okay.
210

211 A: And when that didn't work we moved back to the second (unintelligible). I'll
212 mark that with a number two.
213

214 Q: Sure.
215

216 A: Then we moved back to the position and used the system – the vehicle's
217 public address system.
218

219 Q: And those two vehicles they were there prior to you getting there?
220

221 A: Yes.
222

223 Q: Did you notice anything about them?
224

225 A: Um, I noticed that where I marked the number two, um, when I reached for
226 the microphone for the public address system that there appeared to be, um, a
227 bullet fragments on the windshield (unintelligible).
228

229 Q: Were you -- were you told anything about those vehicles prior to that?
230

231 A: Um, I think in our briefing they had said that those vehicle that had been in
232 that area had sustained some gunfire during the exchange.
233

234 Q: And how -- from -- from your position here at number one were you able to see
235 the house?
236

237 A: I would be able to see, um, at least parts of what I believe number three's side.
238 I had a par- at least a partial view of that.
239

240 Q: Could you -- could you see any windows or openings from where you were at?
241

242 A: Um, no I -- I don't recall because it was a quick peak because understand that
243 this whole area was considered a hot zone so we stayed down pretty low and I
244 know that I just got a glimpse of the building when we arrived to that scene
245 and after that we stayed pretty well hunkered down behind ballistic shields.
246

247 Q: During your briefing were you told, uh, of any possible weapons that may be
248 involved or that that person may have access to?
249

250 A: There was a large list, um, the one that I -- that seemed -- that had been utilized
251 more that they were worried about a 22 caliber rifle that had scope. Um, they
252 said that he -- there was in or at least, uh, reasonably accessible in the
253 residence, an AK 47, an AR 15, um, at least one or two handguns, a shotgun
254 with several rounds including, uh, rifled slugs.
255

256 Q: So a multitude of weapons and...
257

258 A: Multitude of weapons.
259

260 Q: ...and -- and ammunition?
261

262 A: Yes.
263

264 Q: Uh, long did you try and establish contact with him either with the bull horn
265 or the PA system?
266

267 A: I believe that it was approximately if you combine both times we were out
268 there for anywhere from 30 to 40 minutes.
269

270 Q: And after not receiving any response after that 30 or 40 minutes what – what
271 did you do next?
272

273 A: Uh, we returned to the command post, um, and waited standby, um, to see if
274 maybe some point during time that if he was gonna try to establish, uh,
275 contact that we would be available to do negotiations.
276

277 Q: Okay. Was there any other crisis negotiators from any other agency present?
278

279 A: I – I know (Dave) was there (Mori). I believe that he is a negotiator. Um,
280 when we ca- first came on scene I believe there was a negotiator that, um, had
281 been there from Eureka Police Department had been there for quite some time
282 during the evening. I don't exactly know how long but, um, when we took on
283 over after that time I believe they were relieved.
284

285 Q: Okay. And who relieved you from your position?
286

287 A: Um, we weren't relieved until the end of the crisis.
288

289 Q: Okay. So you stayed there the entire time?
290

291 A: Yes.
292

293 Q: Okay. And you had your – your operators from your tactical team there with
294 you?
295

296 A: Yes we had...
297

298 Q: Or around by you?
299

300 A: Yes.
301

302 Q: Okay. Providing security?
303

304 A: Mm-hm.
305

306 Q: Okay. I understand that chemical agents were deployed. Uh, at any time
307 during that process, uh, did you try and establish contact with him verbally?
308

309 A: Uh, I did not. But I did hear over a public address system that they had tried
310 to make contact. Um, you could hear them, uh, asking or ordering him to
311 come out. Um, so I could hear that over the PA system.
312

313 Q: Okay. Do you know who was doing that?
314

315 A: I have no idea.
316
317 Q: Okay. But it was somebody from law enforcement?
318
319 A: Yes.
320
321 Q: Okay. At any time during that process did you see any movement from the
322 house? Hear anything from the house?
323
324 A: No.
325
326 Q: Okay. Could you hear – could you hear radio traffic? Did you have a radio?
327
328 A: I – I did have a radio and I did hear some of our traffic though it was just
329 basically isolated to our frequency...
330
331 Q: Just yours?
332
333 A: ...that we use for CRT.
334
335 Q: Okay. You didn't have any, uh, you didn't have a radio frequency for either
336 Humboldt County Sheriff or Eureka PD?
337
338 A: No I did not.
339
340 Q: Okay. So everything you were hearing was either coming over your
341 frequency or what you could hear coming over the PA system?
342
343 A: Mm-hm.
344
345 Q: At any time did you hear anybody say they saw any movement or that they
346 could hear the suspect saying anything?
347
348 A: I don't recall hearing anything like that.
349
350 Q: Okay. At what – at some time did you realize that the house was on fire?
351
352 A: Um, yeah we – I heard some of the traffic over the radio that, um, there was
353 smoke emanating and, uh, at one point in time I know that we had moved the
354 command post out of the way and they rallied the fire trucks to be put on
355 standby during that time.
356
357 Q: So that was kind of a clue that there was something...
358
359 A: Yeah.

360
361 Q: ...going on?
362
363 A: I mean you could hear different people talking about the situation around the
364 command post.
365
366 Q: Okay. And at any -- at what point in time did you leave when you left your
367 position there by the two vehicles, um, did you ever advance up towards the
368 house?
369
370 A: Um, I didn't return up into that area until after the situation had, um, basically
371 been declared that it was safe to approach. And, uh, I took a quick look at the
372 area just to get a better view or an idea of what the incident site looked like.
373 And I was only there for a few minutes and then I left to go back to the
374 command post.
375
376 Q: Okay. And then from there...
377
378 A: We just headed back home.
379
380 Q: Back home? Okay. Uh, did you carry a firearm with ya?
381
382 A: Yes.
383
384 Q: Okay. And at any time, uh, was that firearm discharged?
385
386 A: No.
387
388 Q: Okay. Did you have any chemical agents with you?
389
390 A: Just, uh, OC pepper spray, um, mark three.
391
392 Q: The -- the hand held?
393
394 A: Yes.
395
396 Q: Okay.
397
398 A: Aerosol canister.
399
400 Q: Do you have anything?
401
402 Q1: I don't have anything.
403
404 Q: Okay. That'll be it. That'll be the interview. It's, uh, 1155.

405

406

407 This transcript has been reviewed with the audio recording submitted and it is an accurate
408 transcription.

409

Signed _____

1
2
3
4
5
6
7 **INTERVIEW WITH SGT. (DALE) HIGGERSON**

8 Q=Det. Lawson

9 A=Sgt. (Dale) HiggerSON

10
11
12 Q: This is Detective Lawson with the Eureka Police. It's Wednesday, June 13,
13 2007 at about 1203 hours here at Pelican Bay State Prison. This will be an
14 interview with Sergeant (Dale) HiggerSON with Pelican Bay. Also present is
15 Bill Honsal with Humboldt County DA's Office. Sergeant HiggerSON, um,
16 how long have you been, uh, uh, employed by Pel - or by CBC?

17
18 A: Ten years and ten months.

19
20 Q: Ten years. And during that time, um, well, what - what are your current
21 duties?

22
23 A: I work - I'm one of the, uh, gang sergeants for the general population.

24
25 Q: And do you have any other - do you have any other duties that are assigned to
26 you?

27
28 A: Yes, I'm, uh, one of the negotiators on the Crisis Response Team.

29
30 Q: And - and how long have you been doing that?

31
32 A: Approximately, six years.

33
34 Q: And I'm sure during that six years you've had training?

35
36 A: Mm-hm.

37
38 Q: The - the - is it the standard training that all the negotiators go through at
39 CBC?

40
41 A: Correct. We have a two-week academy, which is approximately 110 hours
42 long.

43
44 Q: And, uh, how many life crisis negotiations have you been involved with?
45

- 46 A: Uh, we went down and took down equipment to Eureka. They had to
47 barricade the [REDACTED] approximately six or eight months ago and, uh, we got a
48 few different call outs.
49
- 50 Q: On June 3 of this year, um, did you get detailed to assist the Humboldt County
51 Sheriff's Department?
52
- 53 A: Yes, Lieutenant (Dave Morrie) gave me a call at my house on June 3 at
54 approximately 2100 hours.
55
- 56 Q: Okay. And was he requesting...
57
- 58 A: Yeah, he was calling for mutual aide, so I notified the watch commander, at
59 the time (Dana Caves), uh, so he could clear it through the AOD and, uh,
60 notify the proper channels to get approval.
61
- 62 Q: And are you in charge of your - of the Crisis Negotiation Team?
63
- 64 A: Yeah, negotiation leader.
65
- 66 Q: Okay. And, uh, after you were notified, did you make notifications to your -
67 the various team members?
68
- 69 A: Yeah, I notified the Crisis Response Team and put them on standby -- the
70 negotiators -- and then tried notifying our Commander Jeff Ricker - notified
71 the tactical leader, um, (Swift) and then, um, was in communications with, uh,
72 (Dana Caves) the watch commander back and forth.
73
- 74 Q: And, at some point, did you eventually, you and your team, deploy to help the
75 sheriff's department?
76
- 77 A: Yes, we finally got approval at about 2145 hours, um, from the warden and
78 some people from Sacramento headquarters. And then, uh, Lieutenant
79 (Morrie) requested us to be at his office in McKinleyville at about 0600 hours,
80 so we - we arrived there about 0600 hours.
81
- 82 Q: Okay. And upon arrival there was a briefing of sorts?
83
- 84 A: Yeah, he gave us a small briefing. He gave us the [REDACTED] na - [REDACTED] name,
85 uh, ([REDACTED] uh, his age, what kind of weapons he had in there in the
86 incident site; he had a shotgun, AK-47, AR-15, 22 rifle with a scope, 400
87 rounds approximate, um, and different rounds for the, uh, other weapons and a
88 handgun, I guess.
89
- 90 Q: Okay. And after - after that briefing, uh, did you go somewhere?

91

92 A:

Yeah, he requested us to follow him to the incident site and we arrived there at approximately 0740 hours.

93

94

95 Q:

Upon your arrival, um, what did you do?

96

97 A:

Uh, myself, Negotiator (Mozeek) and Negotiator (Dorenback), we went to the command post, uh, trailer, uh, command center - mobile command center they had right there at (Jasper Road) and (Bloody Camp Road) and it was right to the driveway right there. We went in there and got a more detailed briefing on family, on his mental status, different things that would help us come up with a negotiation plan.

100

101

102

103

104 Q:

Do they - did they - and that - did they bring you up to speed as to what had happened from the time you were initially, uh, from what (Dave Morrie) had briefed you on in McKinleyville up until the present time?

105

106

107

108 A:

Correct, they briefed us on - from the very beginning as far as him getting released or getting kicked out from the mental facility in Eureka, um, to the background they had with the residence up at the incident site, all the way to where shots were fired on - on deputies that tried making a, uh, welfare check.

109

110

111

112

113 Q:

Did - things that would be pertinent to...

114

115 A:

Correct.

116

117 Q:

...crisis negotiations? And after receiving that briefing, uh, were any members of your team requested to deploy up to the incident site?

118

119

120 A:

Correct. Before we left Pelican Bay, I assigned team positions and I assigned (Anthony Dorenback) as primary negotiator and (Dave Barneygas) as secondary and then I also assigned the rest of the team members, um, their positions so they could get mentally prepared on the way to the incident site.

121

122

123

124

125 Q:

And once you were up at the incident site, did any of your negotiators deploy down to try and make contact with the [REDACTED]

126

127

128 A:

Yeah, at - approximately at 855, they attempted to negotiate with (Peter Stewart), the [REDACTED] um, they attempted to negotiate with a bullhorn, um, being escorted - security escort, uh, with three of our tactical - tactical element guys.

129

130

131

132

133 Q:

Okay. And when you - when you said they, you - meaning members of your team?

134

135

- 136 A: Correct, Pelican Bay.
137
- 138 Q: Okay. Um, had you been told during the briefing whether or not any other
139 crisis negotiators from any other agency had attempted contact with (Peter
140 Stewart)?
141
- 142 A: Um, earlier in the night, uh, when I was talking to Lieutenant (Morrie) on
143 June 3, when him and I were in contact on the phone, he said they were
144 attempting to negotiate but every time they would they had to hang up
145 because, uh, they would be responding with shots fired. So every time they
146 would try to make contact, shots would be fired, they'd have to hang up and
147 there wasn't much negotiation going on.
148
- 149 Q: Okay. When - when he said hang up, did that - I mean they were on the phone
150 with them - do you know?
151
- 152 A: No, the, uh, the people that were relaying the information to Lieutenant
153 (Morrie) were on the phone...
154
- 155 Q: I see.
156
- 157 A: ...with him. No communications were available inside as far as, uh, phone
158 lines, anything like that.
159
- 160 Q: Uh, at any time, did you yourself leave the command post and - and go down
161 towards the scene?
162
- 163 A: No.
164
- 165 Q: No, you stayed...
166
- 167 A: Once - once the situation was over and they, uh, notified us that the [REDACTED]
168 was found deceased, then we went down there just to get a view of - of the
169 incident site. We were there for approximately five or ten minutes, then we
170 went back to our, uh, van where we set up, loaded our gear and came back to
171 Pelican Bay.
172
- 173 Q: Um, after your negotiators were deployed down towards the scene...
174
- 175 A: Mm-hm.
176
- 177 Q: ...and, uh, did they report back to you as to what happened?
178
- 179 A: Yes, they said they attempted to, um, make contact with negative results.
180 They said they used the bullhorn and the PA in one of the patrol vehicles.

181 From my side of the command post, I could not see which one they attempted
182 to use or what car.

183
184 Q: And during this time when you were in the command post and your
185 negotiators were up towards the incident site, uh, were you in communication
186 with them, did you have radio communication?

187
188 A: We had radio communications. But as far away as they were, our radios
189 weren't working really well so it was really broken up, plus I didn't want to
190 interrupt the, uh, attempted negotiations.

191
192 Q: Okay. And upon them being told to stand down or that the incident was
193 concluded, did they give you any - any of your negotiators give you a briefing
194 as to...

195
196 A: When - when they returned...

197
198 Q: (Unintelligible).

199
200 A: ...they attempted negotiations for approximately 40 minutes. When they
201 returned they just told me that they tried via the bullhorn and via the PA
202 System and they couldn't hear us or get any communication going with the
203 [REDACTED]

204
205 Q: Uh, at any time that you were there, did you hear any gunfire from where you
206 were at?

207
208 A: No.

209
210 Q: Do you have anything else that, uh...

211
212 A: No, we were right behind the command post, um, we set up a cargo trailer.
213 There was one there, um, I'm not sure whose it was either - Humboldt or
214 Eureka. They unload it. Their contents in there - they had some helmets and
215 that kind of thing. They pulled that out and let us set up there and we were
216 right there at the edge of the, uh, (Bloody Camp Road) and the driveway
217 going in and we were there the whole time.

218
219 Q: Okay. I don't think we have anything else. That will be the end. It's 1213.
220 Thank you.

221
222
223 This Transcript has been reviewed with the audio recording submitted and it is an accurate
224 transcription.

225 Signed _____



1
2
3
4
5
6
7
8
9
10
11
12
13
14
15
16
17
18
19
20
21
22
23
24
25
26
27
28
29
30
31
32
33
34
35
36
37
38
39
40
41
42
43
44
45

INTERVIEW OF SGT. BILL NOVA

Q=Man

Q1=Man

A=Sgt. Bill Nova

Man Okay, date is June 5, 2007, time is 1824 hours, Case 200703162. We at the Eureka Police Department in the interview room with Sergeant Bill Nova, Sergeant Detective Schlesinger, and Investigator Dunn. Bill what's your, ah, call sign or badge number.

A L24.

Man Okay, and, ah, how long have you been in law enforcement?

A 21 years.

Man All with Eureka?

A Yes.

Man Okay. Um, and from our understanding you are Commander of Eureka Police Department SWAT Team?

A I am.

Man Okay. And how long have you done that?

A I was appointed as Commander in December of 2001. I was an assistant team leader for the team for eight years before that, and I've been a team member for a total, ah, I don't know if it's 18 or 19 years.

Man Um, what we'd like you to do Bill is just, ah, obviously we're here to talk about the case upon the Northern Camp. Why don't you start from get in the car -- I believe it was the Commander that called you, or something like that.

A I can tell you -- I still got it on my pager, and the page that I got at -- I got a page through our dispatch at 1951 on the 3rd, and that was verbatim, "Lieutenant (Knight) request you phone him at [REDACTED] and can you

46 confirm you got the page to they have a call out in Hoopa, [REDACTED] was the
47 dispatcher. Ah, I called the (unintelligible) and (George Cavinta) and the
48 Lieutenant in charge of there (unintelligible) team, um, he advised me that
49 they had a barricaded, single gunman, um, up above ((Hoopa).is how it got
50 put to me, um, and they were -- looked like they were gonna end up being
51 there all night and they were requesting a mutual aid, um, with my team to
52 respond and relieve them. Um, I told em that I'd call em back, because I had
53 to go through our channels here obviously. Um, I called our crew unit
54 commander, Lieutenant (Snotty), um, he gave authorization, um, then I -- he
55 told me to get a hold of Chief to confirm, which I did. Chief (Cleve Voss)
56 authorized that, ah, we go ahead and respond. So, I called ([REDACTED]) dispatch
57 back and had em put out a group page to SWAT, and to, ah, the Negotiation
58 Team. Um, at that point it started from home to start- just, ah, mapping up
59 where in the hell we were gonna get to -- put a couple more calls in to, ah,
60 (JR) (unintelligible), and ah, ah, status update. Um, he said that, ah, he would
61 like us to be out there -- like I said, this was probably going on between like
62 800 and 900 at that point, um wanted us to be out between 200 and 300 to
63 relieve their guys. So I started getting calls in and just started doing the
64 logistics and putting it together. Um, I got all my team members and, um,
65 three of my tactical pro rifle folks which is, ah, Officer (Gary Cooper), um,
66 (Luis Altic), who is also one of my, ah, chemical agent instructor after
67 (Brendon) (unintelligible), and, ah, (Greg Hill). Ah, I also spoke to Sergeant
68 (Kay Howden) who is the, ah, CNT Commander, um, due to the fact that I
69 was already stripping some of the detectives bureaus here, I didn't want, ah,
70 pull (Kevin Larson) who is also, um, the negotiator up there. (JR) had said
71 that if I could bring up two that'd be great, so, um, I told her I'd like her to
72 respond and where to meet, along with, ah, (Ed Wilson).

73
74 Um, did some more planning -- we linked up -- everybody was here at, ah,
75 1230 or 0030 hours on the 4th. Um, I gave em a quick, ah, operational order
76 from the information that I had on hand, ah, loaded everybody up, loaded
77 team equipment, and drove out there. We arrived between 200 and 300 -- I
78 think it was a little- probably about 215 or so. Um, the team disembarked in
79 the CP area. I started, ah, getting gear out, I met with, ah, (Cavinta), got a off
80 word from him, and a situation report from him up to that point. And, ah, a
81 basic A plan of, you know, where he thought things would go once daylight
82 came around. And, ah, we took a look on the map where his, ah, (okees) and
83 parameters was. Divided my team members up and we began inserting the
84 replacements, my guys for his, ah, internal parameter folks. Um, that
85 accomplished, probably between 300 and 400 we'd totally relieved them of
86 their inner parameter. Um, had eyes on until -- I think our operational
87 evolutions be good till 800. And, ah, you know, ah, the team -- primarily the
88 teams at the, ah, expedition on the main road in front of the place, ah,
89 obviously had the best eyes on. Um, they- I think they were about 6 -- I think
90 it was 60 some yards out, the other two inner parameter teams that, um, they

91 were spaced a hell of a long way away. Um, the team that had the
92 (unintelligible) I don't know what the hell I did with my, ah (unintelligible)
93 log. Um, basically the- that inner parameter that first night there, um -- I had
94 the bulk of my team stationed here, so that they had the observation, this was
95 the four side -- we had a team way out over here -- probably 80 yards.
96
97 Man Here by the- the group of our cars (unintelligible)?
98
99 A Yeah, by that lead Expedition.
100
101 Man So can you put a one in there?
102
103 A Sure.
104
105 Man That's for -- and that will stand for your basic team.
106
107 A And I know they were exactly there because I was up on line with them off
108 and on during the night.
109
110 Man Were you -- Bill were you coming- coming from- from your one position
111 from the command post...
112
113 A From the command post, back and forth up this road.
114
115 Man Okay.
116
117 A Um, the other team inserted -- and I don't know exactly where they were --
118 but they had a- a visual of, um, of um, of basically this one four corner to the
119 one two corner over here.
120
121 Man Okay.
122
123 A But I don't know where specifically...
124
125 Man But over on the west side, over there?
126
127 A Yeah, they were over on the west side and basically they were the- the SO unit
128 that was that they were over in this area.
129
130 Man Who is they?
131
132 A Um, let's see...
133
134 Man Not necessarily -- is it still part of the SET Team from the Sheriff's Office?
135

136 A Yeah, I'm just talking to SET.
137
138 Man Go ahead.
139
140 A Ah, the only people on that inner parameter that night that I know of were-
141 was the SO SET Team. Um, she- she didn't come up till the next day, we had
142 no CDC people there, so it was just the Sheriff's Office, and us. Um, the 13
143 inserted up and they were up on top of this ridge line somewhere, so that they
144 had some observation of the three side, and this two side, for what it was --
145 not sure of exact position but -- I'll call this three.
146
147 Man Okay.
148
149 A So, basically we -- with the three teams they had coverage observation-wise.
150 Um, rules of engagement is given by, um, (Cavinta) was that, ah, we -- that it
151 was a no fire situation unless there was an immediate threat -- either he came
152 out the window with a gun or if he was inside and pointed the weapon and
153 began firing shots. If he actually presented out the weapon, ah, outside, then,
154 um, we were operational condition to fire him if we felt the threat. Basically
155 it was gonna be up to the operators on scene at that time to make that
156 judgment...
157
158 Man Okay.
159
160 A But they weren't relegated to wait for him to -- be fired on.
161
162 Man Bill can you tell me the members that responded and what their- at least did
163 they have a specialty on the team and what they do?
164
165 A I can. Um, it was myself, a Detective (Wilcox) who is my senior team
166 leader, Officer (Sanchez) who is my assistant team leader, Sergeant (Johnson),
167 Officer (Jones), who is also a chemical agents instructor in (Grenadier),
168 Officer (Harpom) who is also my, ah, sniper team leader, (Greg Hill) who is a
169 patrol rifleman, Officer (Gary Copper) who is a patrol rifleman, and Officer
170 (Altic) who is a patrol rifleman and also, ah, chemical agents instructor and
171 (Grenadier).
172
173 Man Okay.
174
175 A Um, I also have my Tactical Dispatcher [REDACTED] and that first
176 operational period I had Sergeant (Howden) and Officer (Wilson) upon the
177 scene.
178
179 Man Okay. Did, ah, (Howden) and [REDACTED] did they try any negotiations at all?
180

181 A No.

182

183 Man No?

184

185 A No. They, ah, came up -- and I had them positioned at the first, um, whatever

186 patrol unit that was -- I don't remember if it was an SO or a tribal car.

187

188 Man Okay.

189

190 A I had them set back because they weren't, ah, body armored up enough to do -

191 - originally they wanted the negotiators up there and -- I didn't like that, so I

192 moved them and left them back here, kept the tactical folks up front.

193

194 Man Okay.

195

196 Man So that first night did, ah -- as- as you guys deployed, did you take over from

197 (Cavinta)?

198

199 A (Cavinta) stayed on the scene in the mobile command -- but yeah, in essence I

200 took over tactical command at that point.

201

202 Man Okay. And during that time did anything arise at all or anything with the

203 [REDACTED] that was in the house?

204

205 A The [REDACTED] was, ah, was up, ah, we had several observations of him moving

206 about in the house. Most of the lights were on in the house. And like I said, I-

207 it was a narrow view. I didn't go to the- the, ah, two and three OP positions,

208 this was the only position that I was checking on consistently because these

209 were hard trucks and relatively exposed, so I was about to start giving

210 positions away. Um, lot of activity of him just kind of wandering around and

211 kind of -- I mean at one point it almost looked like he was doing a chicken

212 dance and I'm- I'm assuming this is a living room or greater room area. Um,

213 he was flagging his arms around and goofing around, I don't know what he

214 was doing. Never ah, really said anything, but there, you know, it was

215 definite that he was up and around. Um, right at -- if I remember right -- I

216 think it was right at 5 is when I think it was to get, ah, nautical sunrise. Okay

217 and we had movement up until 454 -- and 455 I started moving -- I moved at,

218 ah, about 455 because the light, um -- my number two guys were in this unit

219 up here.

220

221 Man Right there and (unintelligible).

222

223 A They were using (unintelligible) tribal.

224

225 Man Okay.

226
227 A But because it was so close, once it started getting light, they got in and they
228 moved that vehicle back up the road at least 70 yards. Um, so that they had
229 just a better position as far as coverage.
230
231 Man So it's -- they moved this then?
232
233 A Yes, they moved it from whatever original position it was in. It's my
234 understanding that this vehicle was pretty fucking close.
235
236 Man Okay.
237
238 A Quite frankly.
239
240 Man And that's what my understanding was when we went up there, yesterday...
241
242 A (Unintelligible).
243
244 Man It seemed like it was a lot further away.
245
246 A Yeah, and- and, um, that was, um, (Ron Harpom) was here, and he said that,
247 ah, their position was gonna be compromised as soon as light started up. And
248 when it started getting light they went ahead and moved that vehicle, he -- it --
249 position two was (Cooper) and (Harpom), and they moved back up between
250 60 and 80 yards from where the original position of that vehicle was.
251
252 Man Okay.
253
254 A And (Ron) can probably give you a better, ah, estimate of how far back up to
255 where they moved.
256
257 Man Okay.
258
259 A Um, because I know that they -- he had to lose some observational coverage
260 of the residence when they moved, but it was the on, ah, only safe place to go
261 to and still keep some kind of coverage on it. Um, 509, according to our log,
262 um, was when he shut all the light off. And I just associated it basically with
263 the nautical sunrise, you know, nautical skylight coming up. Um, but
264 basically about that time, um, all of a sudden he shut every light off in that
265 house and it went totally black. So...
266
267 Man And did the movement stop at that time too?
268
269 A Well we never really heard him moving around. I mean we saw him or saw a
270 cast shadows of- of a person, you know, I mean he was backlighting himself

271 off of lamps or whatever the interior lighting was. Once the lights went off
272 we really didn't hear -- from my recollection, or see him -- no we didn't see
273 him at all -- I'm just run through the logs here -- okay, and that's -- we had
274 nothing else. Once the lights went out there was no, um, no movement that
275 was heard, and obviously none that was seen.

276

277 Man Okay.

278

279 A Um, we started, ah, evolution change over at 730, um, at 756 the SOs last
280 teams were, like radioed that they were moving in to relieve us.

281

282 Man Okay.

283

284 A And by, probably 850 or so I had all my people back in the CP van.

285

286 Man Okay, and in by that time Lieutenant (Cavinta) took back over?

287

288 A Yeah.

289

290 Man So when- when next did you guys become involved again?

291

292 A Um, we went back operational in conjunction with SO SET at 1001, per the
293 log. Um, I put my people down right there at the CP, because we- I knew
294 that, um, (JR), was, um, Lieutenant Commander was looking at going with the
295 gas plan pending no further negotiating, ah, -- pending the same result we had
296 the day before, the guy wasn't negotiating. Um, so I put my guys down for a
297 couple hours and we'd -- already pulled a minimum of 12 or more at that
298 point anyways. Sat down with, ah, Lieutenant (Cavinta) during that time
299 from, probably before 800 actually, because I think he was up around 630, but
300 we started talking about tactical options at that point, team (unintelligible) and
301 there was a couple of other SO people in the truck now. I don't remember
302 who it was that came in. Um, I know that he was talking to, just staff
303 (unintelligible). We got, via phone, um had his team leader come in, and we
304 talked about some options. And, um, then we sat down and took a hard look
305 at where we were.

306

307 Um, recommendations and, ah, plan of action at that point was that we were
308 gonna, ah, attempt to reestablish some kind of negotiation -- or establish -- not
309 reestablish, establish some kind of negotiations with this guy. Um, give him a
310 minimum of a couple -- at least two hours, um, and if there were no
311 negotiations establish, then we were gonna start to get some in there -- a gas
312 plan between, say like 1100 to 1200ish. But, um, we wanted to try that, um --
313 I remember what it was. He had put a call in, I think but I'm not positive, I
314 think he put -- he had called for some CDC assistance to bring their
315 negotiators out, because I'd released (Howden) and [REDACTED] so they were

316 gone by 9 o'clock. I think I'd cut them a loose at 900. Um, (unintelligible)
317 was either on the scene or coming up to the scene, and, ah, the call had gone
318 in at some point (unintelligible) from CDC. Um, somebody also talked to
319 (Morris), who is the SO negation commander, I guess. Um, because
320 apparently the guy that had phone service but it had been cut off for non
321 payment.

322
323 One of the things we were looking at was to get a hold of whoever that service
324 provider was and at least have them open the line up so that we could make
325 calls in, and be ensured -- make sure no calls out, but we figured, you know if
326 he won't respond to the- the, ah, PA, voice to voice we had, and there's a
327 phone inside we can shoot the phone in. Um, about the time that you get a
328 negotiator up front, um, is when we found out -- he found out and relayed that,
329 ah, apparently there was no phone whatsoever in the house, and that kinda
330 threw that option out the window.

331
332 Man What- then wh -- in this discussion that, huh, did- did would you say this was
333 kinda like a means of what your type of game plan was gonna be for the rest
334 of the day?

335
336 A Kind of an outline, ah, and it was just there was constantly involved with his,
337 you know, where we'd talk about something to see if it was gonna be feasible,
338 you know, like the sun thing. Um, they- we were starting to work on that and
339 then we'd -- and I don't actually remember, frankly, where the intel was but
340 (JR) came back and said, "Well, that's out the window because there's no
341 phone in the house." So now its (unintelligible), how else, you know, do
342 negotiations. As far as, ah, introducing a throw phone -- it was out of the
343 question. Um, because of the, ah, open area around that residence, there was
344 no -- and we have no ATC to effectively take a- a throw phone team up there
345 close enough to deploy it. The fact that he'd already, ah, engaged, ah, officers
346 twice with gunfire, um, we felt that was an unfeasible option to try to get up,
347 because you're talking about how we get within 10 feet of an opening on there
348 to be able to deliver a throw phone inside there. Um, that was never an
349 option. Um, it was just way too risky for our personnel.

350
351 Man Okay. So, what was you guys -- obviously the way that things changed -- but
352 your outline at that point...

353
354 A Our outline was to, um, go to the voice to voice over the PA system. Um,
355 with (unintelligible), and continue -- hit the siren every now and again to try
356 to get attention, but continuous PA announcement for a surrender order, or to
357 at least, you know, try to open some kind of dialogue, um, with the guy inside.

358
359 Man Uh-huh.

360

361 Man And as far as you know Bill, negotiations never occurred...
362
363 A No there was never negotiating. And I -- when I say negotiating I mean at
364 that point it, you know, we were looking at this as basically an active shooter
365 situation. There's not a not a negotiations per se, our (unintelligible) was to
366 get him to at least respond and say, we're not leaving, we're not going away,
367 you're gonna go to jail -- that's just how it's gonna be, um, and this is the safe
368 way that we're gonna conduct it, and you know, go to the door. Raise your
369 hands, officers, you know, the whole bit.
370
371 Man Those were more the orders that the negotiators were gonna maintain?
372
373 A Yes. Um, so that's where we're at. And that went on for -- couple hours...
374
375 Man Okay.
376
377 A At least.
378
379 Man And...
380
381 A Also during that time, I mean, we're- we're stage- and restaging medical, fire,
382 and we're trying to get, ah, um, medical (unintelligible) either through -- reach
383 out of Redding, ah, CHP, but the weather was turning foul, so in essence we
384 didn't get anything coming from the Valley side. Um, I think ultimately we
385 got a half ass commitment from, um, CDF that, ah, you know, if we had
386 somebody and they would- they would respond. Um, my (prime arial) he was
387 up at the cross. Second arial, he was basically -- we were gonna put him
388 down below where the MCC was, and that, ah, guy is open field there. But,
389 um, I mean there was a lot of stuff in addition to, um, once again, CDC started
390 coming in and staging -- that was around 1000 am. Um, I believe -- to my
391 recollection, that was, ah, I think that's six negotiators show up with all their
392 equipment -- six to eight negotiators with all their equipment. And four to six
393 of their tactical or SWAT personnel, whatever they call em, um, showed up,
394 to ah, to assist.
395
396 Man Okay.
397
398 A Um, 10 o'clock -- at 1001 from my tact dispatch log, um, both my- my team
399 started staging to reinforce the parameter.
400
401 Man Okay.
402
403 A Um...
404
405 Man So you the last fellows out and so you were...

406
407 A No we were going out there to augment. We were not going to intermingle
408 but just augment the inner parameter at that point. Um, obviously both my
409 gas personnel, which is (Jones) and (Altic) took their chemical agents there
410 with them.
411
412 Man At that time?
413
414 A At that time. They took it with them out on site. Um, all our gas is numb.
415 We don't have any pyrotechnic gas whatsoever, in any way shape or form, so
416 they had, ah -- initially they took out 237 millimeter gas launchers, and ah, gas
417 rounds, um -- no we didn't -- I don't we had any handhelds at this point. I
418 don't know, they may have had a couple of, ah, aerosols handheld, but ah, and
419 they also took a 12 gage with, ah, CS skirts -- all of our stuff is CS. We have
420 no (unintelligible) except for, ah, some of the hand-held stuff.
421
422 Man So they went- went out but they took all their chemical agents there with
423 them.
424
425 A Yeah.
426
427 Man Okay and at that- b- before that did, ah, you and (Cavinta) talk about, you
428 know, um, introducing the chemical agents into the house?
429
430 A Yeah. Um, the initial plan, um, that we came up with, um, based on the
431 distances that we're looking at in the daylight, was that, ah, gas would be
432 introduced into the site for A and B openings, just because it was the shortest
433 distance to put in. Um -- what was it -- and we were going to do -- I think it
434 was 10 rounds, a total of 37. So, um, five volleys, two rounds each, one round
435 each window.
436
437 Man And that was you guys, or that was the SO?
438
439 A That -- well the SO would be deploying it.
440
441 Man Okay.
442
443 A But that in the top, that was...
444
445 Man Okay I just...
446
447 A (JR) and I talking to the command post.
448
449 Man Okay.
450

451 A We figured if we can introduce it -- yeah, that gonna be the initial, most
452 feasible area that we were actually gonna get it to -- A through an opening, I
453 mean glass or wood based on distance, and two for the- the chemical agent
454 round actually could (unintelligible), all they have to go through that they
455 gotta break open and dispense the chemical. Um, the further away you are --
456 because they're- they're black powder charged round, so they're limited on
457 distance, and the further distance you get away, which turned out in this case,
458 um, the further away you get, ah, they lose kinetic energy -- tremendously.
459 Um, and so that was our most viable point to introduce it and have it affect- be
460 an effective introduction.
461

462 Man So what the plan was down here by the (Hoopa) Valley travel cars?
463

464 A Right.
465

466 Man Okay.
467

468 A And they- they would fire gas into these two openings on the four side.
469

470 Man Okay.
471

472 A That was accomplished for the first volley which was, um, (unintelligible), we
473 initiated gas -- SO initiated gas at 1114, from my log. Um, at 1119 X10,
474 which is -- I think it's (Cornell)...
475

476 Man Yeah.
477

478 A He was the team leader at this position.
479

480 Man At one?
481

482 A At one, with, ah, SO units, um, five into A B windows, it was number four
483 sides. So they put five rounds of 37 into each window.
484

485 Man Okay.
486

487 A Um, (Ireland)'s radio went down, so I had, um, (Sanchez) move from his
488 position over to wherever -- and I don't know where (Ireland) was, but move
489 over to (Ireland)'s position because he did not have communications with the
490 talk any more.
491

492 Man Okay.
493

494 A At 1124, 83 was in position. At 1126 (Cornell)'s team introduced the second
495 volley of ten rounds into the four side A and B windows, according to my log.

496 Um, at 1132, 3X10 reported rounds entered -- no movement. At 1135 there
497 was transmission and the source is listed as X10, broken window on the one
498 side, so I don't know -- that probably didn't come from X10 because he had
499 no view, but supposedly this L here is considered -- this whole L is considered
500 one side -- there's the broken window.
501
502 Man Does he (unintelligible).
503
504 A Um, at 1135 (Cavinta) told his- this number one team, ah, to move to the -- by
505 the two corner and introduce five round -- I'm sorry -- one, two corner -- five
506 rounds into, um, this (unintelligible) -- that would have been my personnel,
507 because I had someone stationed here (unintelligible), can you halt the tape. I
508 need to go and...
509
510 Man (Unintelligible).
511
512 A I'll be right back. All right -- so during daylight on the 4th I had, ah,
513 (Sanchez), (Jones) all take (Hill), (Wilcox), and (Johnson), (Cooper), and
514 (Harpom) basically covering this two side up there -- this area here, probably
515 (unintelligible).
516
517 Man These guys that you just named, now were over on the two side?
518
519 A Yeah, when we deployed to go argument the parameter this is where they
520 went.
521
522 Man Okay.
523
524 A Um -- yeah. So I had my entire team covering up here.
525
526 Man Okay.
527
528 A Um, like I said before, ah, when (Ireland)'s radio went down 83 split off from
529 this group and joined wherever (Ireland)'s position was so that they could
530 maintain common with MCC.
531
532 Man Okay.
533
534 A So, we decided to put fiber rounds into the mas -- we were calling this the
535 master bedroom. Um, both (Jones) and (Altic), ah, took turns firing --
536 because we single, ah, single launch 37s, so one would fire, the other would
537 fire as the first one was reloading, when it came up to the energy
538 (unintelligible) round into that number two...
539
540 Man So they alternated the five rounds into number two?

541
542 A Yes, yes. That's my understanding in- in debrief from them.
543
544 Man Okay.
545
546 A Ah, let's see -- okay. At 1130 -- let's see moved to one two sides, so they
547 could, probably adjust the position. They were up in this area but that was
548 when -- that was their firing position, was basically, ah...
549
550 Man Straight on in, them two?
551
552 A (Unintelligible). Um, this was an 81 yard shot. I know that because they were
553 -- they, ah, told me during and then afterwards that they'd actually put a laser
554 rangefinder on it. Um, so it was a hell of a shot and they weren't sure if they
555 were gonna get any into that place. So, let me see -- there some reports of
556 movement inside that room, um, at 1137 we had radioed that, ah, my team
557 was moving...
558
559 Man Movement in the two?
560
561 A Inside- inside this master bedroom area.
562
563 Man On the two side?
564
565 A On the two side.
566
567 Man Okay.
568
569 A And that was, um, (Bishop) that reported that, according to the log. At 1139
570 my team was still movement -- if I recall right I think they were up in this area
571 so they had to move all the way around and get into a position up there.
572
573 Man Which team was that?
574
575 A Mine.
576
577 Man And your team was the only one up there.
578
579 A My entire team- my entire team...
580
581 Man Started on the...
582
583 A Started...
584
585 Man Okay.

586
587 A Over here covering this three side area.
588
589 Man Okay.
590
591 A So we had given them the command to go ahead and reposition so that they
592 could put it in, the whole team went.
593
594 Man Now, Bill when- when you- when the SO SWAT team put in the rounds...
595
596 A Uh-huh.
597
598 Man Um, they were over on number four side, right?
599
600 A Yes they were on the four side.
601
602 Man And was it decided by you and (Cavinta) to have your team go to the number
603 two side put the other...
604
605 A If I- if I remember right, I think (Bishop) reported that, ah -- let me check
606 because it's all kind of flows together in places. Okay (unintelligible). So at
607 1135 -- next thing we had the broken window, what happened at that point in
608 time, um...
609
610 Man What- what was it thrown that broke a window.
611
612 A I- I don't know, frankly. Um...
613
614 Man It got broke (unintelligible) or...
615
616 A I- if I recall right, I think somebody up on this area here -- and I don't
617 remember who it was, reported that a window was out.
618
619 Man Okay.
620
621 A So they put a second volley in -- second volley started -- that was at 1126.
622 They introduced the second volley, so now there's a total of ten rounds into
623 each room or- or entry on the four side...
624
625 Man That'd be twenty all together in here?
626
627 A No, ten. I'm sorry -- wait a minute -- yeah ten into each, a total of 20 the
628 total. So ten into whatever room that A port was and ten into the port of --
629 window of this room.
630

631 Man Okay.
632
633 A Um, 1132 (Cornell) says, "They're done firing," um, he- he reports rounds
634 entered, no movement. 1135, ah, (Cavinta) con- gets on the and confirmed no
635 movement. 1135 X10 -- I don't know how the hell X10 up with that -- it's got
636 a -- I don't know, you'll have to talk to, ah, to (Olson) about that. That info
637 source is listed as X10, but a radio report came in -- broken window on the
638 one side, which is this L area.
639
640 Man Okay.
641
642 A And I don't know specifically where. 1135 (Cavinta) wanted move -- the gas
643 team to move to the one two side, and enter five into the master bedroom. My
644 team was already up on top, um, so that movement started.
645
646 Man Okay.
647
648 A Um, at 1136 source information -- radio source information from (Bishop)
649 says they had movement inside, ah, the two side window. So somewhere in
650 this two side right here.
651
652 Man Okay.
653
654 A Um, 1137 (unintelligible) up for volley on two side, we're out. That was for
655 X10, according to the log. So the team was moving, um, at 1140 (Cavinta)
656 put out to prepare for another surrender order, which would have been for
657 (unintelligible) to start PA. Okay (unintelligible) there was quite a time lag
658 trying to get into a position up here. So at 1157 my team leader (Wilcoxs), ah,
659 wanted to know what the range was gonna -- because I think (Bishop) and
660 (Ireland) were together as a sniper on that -- if I recall correctly, up in this
661 area. (Bishop) came back 105 yards from whatever position they were in -- to
662 the two side. Um, my team later came back and confirmed that their- that
663 they'd- their team was to stay east of the barb wire fence, so they're still
664 moving around. Um, they talked back and forth -- this is the inner team
665 communication going on between mine and (Bishop), and the sniper element
666 up here as far, you know, do you have coverage on that, while they're moving
667 in closer. Ah at 1203, um, (Wilcoxs) got on the air, asked, ah, (Jones) --
668 basically was confirming what the yardage was, and it was 84 yards, and
669 that's as close as they could get. There was some more communication, um,
670 back and forth, and... So between 1203 and 1206, my gas guys were in a
671 position -- they delivered five, because at 1206, 64 reported five good rounds.
672 The first volley misses -- which is what happened -- they fired -- they were
673 either bounced off or missed completely. And then they got five in, is what
674 was reported.
675

676 Man And those were the 37 millimeter?
677
678 A 37 millimeter.
679
680 Man Those CS ones?
681
682 A Heavy barricade penetrators, CS, none (unintelligible). Um, at -- following
683 right on the hills of that transmission, (Cavinta) radioed X10 follow
684 (unintelligible) volley go with ten of our own back on the four side. So that
685 would've been five and five.
686
687 Man Okay.
688
689 A A opening, B opening. Um, (unintelligible) primarily X10 traffic to MCC.
690 Okay, so they introduced five, then these guys introduced five each. What the
691 hell is all this -- 67 reported that, you know, due to that misses, slash --
692 actually they weren't -- completely that they were misses, they were hitting
693 and actually bouncing off the windows because of the distance.
694
695 Man Okay.
696
697 A Um, he was reporting that they were at max limit for- for the equipment to be
698 effective. Um, there was some inner communications, went back to surrender
699 orders via the PA system, um...
700
701 Man Bill let me ask you something right quick. Was -- if you've only got five
702 rounds in here...
703
704 A Uh-huh.
705
706 Man Okay, in the back on number two, and say they got half of what they shot in
707 here, would it- would that show up this- this trailer in the add on?
708
709 A If it was sealed -- yeah.
710
711 Man Okay.
712
713 A The problem was, um, the wind was basically -- at that point and time,
714 blowing through in this direction. So from...
715
716 Man Is that north?
717
718 A Basically from -- yeah south to north. We had, based on the intel and the
719 information was that we have this quarter area...
720

721 Man So you had a (unintelligible).
722
723 A Had a bedroom, a hallway, ah, a bath somewhere in this area, another room,
724 then this living room, great room area type thing. And then some kind of
725 small room, I really don't know what this was. But because of the wind, and
726 the fact that now this was ported and completely broken out for the most part,
727 this window was busted by the 37s, and now we have at least one window
728 busted out in the back -- basically we now have a wind tunnel.
729
730 Man Okay, I see what you're saying.
731
732 A So, um, introducing the gas if it was sealed then, yeah. I mean that should
733 have been effective to drive most rational people out of the house. But that
734 stuff, you know, it basically goes in and it hit articulate matter and it drops to
735 the floor. So it doesn't create, like a- a smoke grenade type of effect kind of
736 thing. So, you know, a lot of that stuff is -- was blowing out.
737
738 Man So say, with it blowing out like that, if you've sealed yourself into another
739 room...
740
741 A You would be protected.
742
743 Man You'd be protected?
744
745 A You would get some effect but it would be (unintelligible).
746
747 Man Okay.
748
749 A So, getting back, um, (unintelligible) two side -- at that point around
750 (unintelligible) thereabouts, we started looking at trying to deploy gas
751 because of that issue, from the three side because there was no closer distance
752 at that one side. We tried to maneuver an element over to the three side to try
753 to put gas through the walls here, and thus deny this one room here and this
754 bathroom ideally where- where it was. Um, because we figured the- the front
755 or four side rooms were probably becoming pretty miserable. You could live
756 in it but it's gonna be miserable, because that stuff all over the carpet. And we
757 figured we had enough chemicals into here that it'd make things pretty
758 miserable now. And the whole point of a gas plan is to start routing the
759 ████████ to an exit and get him out.
760
761 Man Uh-huh.
762
763 A So we'd hit- hit the south end of the residence. Hit- hit at least the first room
764 of the north end of the residence. Um, not with as much effect as we wanted
765 be they got some rounds in.

766
767 Man So you guys would imagine he'd be somewhere else...
768
769 A So we figured, you know, since we weren't getting any- any, ah, report that
770 you know, he moving, and no, you know, they weren't even picking up any
771 coughing or yelling inside, that he, you know, the thought process is, he's
772 probably gone to ground. And he's gone to ground in one of the non
773 contaminated rooms. So, um, the plan was to move -- since my team was
774 closest, and rather than do all the way back and up and around, um, we split
775 off and, um, (Jones), (Altic), and (Hill), and, ah, my senior team leader,
776 (Wilcoxs) then moved to a position where they could engage this three side of
777 the structure with gas. Um, which is what they did. This would have been
778 their number two firing point.
779
780 Man Okay. And who would that have been?
781
782 A That was- that was (Jones), (Altic), (Hill) and, um, (Wilcoxs).
783
784 Man And how many was into that three side?
785
786 A So they moved back around and, you know, we're still going between these
787 volleys, putting back on the PA, you know, to get him to come out and the
788 whole litany. Um, 1255, um, (Wilcoxs) said, ET on deployment on the three
789 side that they were basically moving. At 1258 (Wilcoxs) basically says that,
790 ah, they're in a position for deployment, um, and to have SET advise when
791 they're ready for them to go. 1258 -- and then he followed up and he says
792 they're about five minutes from the final position to the firing point
793 (unintelligible). Started getting some intercoms with -- you know everybody
794 is mastered back up again. (Unintelligible) 1258, ah, 1307 X10 comes on the
795 air -- will have to break a pane of window. Window's been attempted with 12
796 gage. Then we evaluate for a (unintelligible), grenade prepared for port. So,
797 as I -- cause I was running my team at that point for this, we're right here and
798 (JR) somewhere bouncing back and forth. He's running his dispatch
799 (unintelligible) than mine, um...
800
801 Man So pretty much in the command post, you're- you're dealing with your team
802 and (JR) is dealing with...
803
804 A Right.
805
806 Man His team?
807
808 A Yeah, for the most part...
809
810 Man But you guys were still meeting in the middle...

811
812 A Yeah.
813
814 Man To make sure of what's going on?
815
816 A Right. So my recollection is that we were going to have my team put in 37
817 here, and then have X10 and his gas element introduce some 12 gage
818 (unintelligible).
819
820 Man Okay.
821
822 A So, commencing gas at, ah, 1309 -- (Jones) radioed in that they're
823 commencing gas. So they begin firing from this (unintelligible) here. Um, I
824 have no range estimation on this because they didn't have the, ah, rangefinder
825 from that position. It wasn't as far as- as the initial firing point, but you know,
826 if I had to guesstimate it, it was an easy 60 to 70 yards.
827
828 Man Uh-huh.
829
830 A So they were still out quite a ways. Um, at 1311 X10 reported that they'd
831 ported the windows with their 12 gage, um, garrets.
832
833 Man Explain that (unintelligible) round to me?
834
835 A Um, it's a 12 gage roun -- basically it's a miniature 37 millimeter gas round.
836 It's- but it's a 12 gage -- it's a small thin projectile plastic, and it does the
837 same thing that a 37 does, it's just up like two grams of CS versus, like six
838 grams in a 37.
839
840 Man Okay.
841
842 A So they both do the same thing, just different caliber, different delivery
843 system.
844
845 Man Okay.
846
847 A Um, (unintelligible), that was two three side, so -- okay. So at 1311, um,
848 (Jones) reported that they had four- four 37 millimeters that they were
849 confident actually entered this three side.
850
851 Man Okay.
852
853 A X10 comes back reporting window -- which was the 12 gage -- they both --
854 there was radio traffic back and forth, um...
855

856 Man Hold on -- does it have actually how many were shot, or do you guess here?
857
858 A No, I'm -- I don't remember positively how many they fired -- a minimum of
859 five. It may have been -- they may have requested ten, but I don't think so. I
860 think this was a five count -- I think this was supposed to be five and we had
861 them actually, because they had the majority of the first five bounce off...
862
863 Man Okay.
864
865 A We had em fire another five at it to try to get the majority in.
866
867 Man Okay.
868
869 A But this side over here, to the best of my recollection, was five rounds only.
870
871 Man Okay.
872
873 A Because they were also introducing again...
874
875 Man On the three side?
876
877 A On- on -- yeah. Five on the three and then ten of the 12 gage
878 (unintelligible)...
879
880 Man Okay.
881
882 A On the four side. So they reported that they got, um -- what did I say? Four
883 in -- that they were confident it actually came into this number three side out
884 of spreads. So they would have, you know, I don't know exactly where they
885 would have put em in, but, um, they would have spread it. It wouldn't have
886 been in at one target area. It would have been, probably walk em down the
887 wall...
888
889 Man Okay.
890
891 A To really get coverage in this hallway area. Um, at 1317 (Jones) wanted to
892 know from me whether I wanted them to move to the two three corner, um,
893 and to play rounds. I told him, no. They- they were just to remain there and
894 hold. It was about at that point that (Cavinta) had this team go up to introduce
895 the first two handheld devices. They got a, um -- his team used ballistic
896 blanket to maneuver the gas team up, and they introduced one handheld, ah,
897 device into A, and one handheld device in the B on the four side. When they
898 came back, X10 reported that there was a large caliber stainless or nickel
899 revolver that they could see on a table inside this room.
900

901 Man Okay.
902
903 Man The- the handheld thing, can you explain that principle to me?
904
905 A I'm assuming it's something like ours. Um, we all use pretty much the same
906 stuff. It's the (Deftext), um, if there's a number of models you can get. And
907 we, um, my teams uses -- it's a CS non pyrotechnic so it's not a, um, a CS gas
908 burning device. Um, what it does it that it'll blow out, and it just basically
909 blows a big cloud of- of CS into the room.
910
911 Man Kinda like an aerosol can...
912
913 A Yeah.
914
915 Man Type of thing?
916
917 A Very similar to an aerosol type can. It looks kind of like a- a military smoke,
918 different color coding but it about the dimensions and shape of a- of a smoke
919 grenade.
920
921 Man Okay.
922
923 A Ah, when it goes off, like I said it, you know, it blows out the contents of the,
924 ah, of the CS into the room. Um, so for the most part it- it -- and it's- it's
925 probably double or triple the CS content of a 37.
926
927 Man Okay.
928
929 A So it carries quite a bit more, um, (Jones) can tell you what the ground size per
930 each thing is, (unintelligible) expert. So they- the SR team puts one in the, ah,
931 port A and port B on the four side. Um, they report that they had a large
932 caliber in this room on the- the A opening of the four side. Um, at that point
933 we started calling -- I starting with my team, um, of what handhelds they had,
934 um, some talk back and forth about feasibility if they could deliver handhelds
935 in here. Um, basically it was all for not, because there was no -- basically the
936 only the- the- the quickest approach, and the shortest approach was just off
937 this four side. And that pretty much negated all of the one, two, and three
938 sides as far as actually getting a team up close up without, um, probably
939 sacrificing a whole lot of safety doing it. Um, 64 comes back. They got a
940 couple -- we had a couple of aerosols with our team, but that was it, just CS
941 comes back and forth about feasibility of approaches. Somewhere during that
942 period of time there was goofy ass intelligence coming from -- I don't know
943 where that, um, there may be people in the house. So (JR) was booking on
944 confirming that intelligence. And our teams (unintelligible). During that
945 period of time CDC said that they had some- they had CS smoke canisters that

946 they could provide to X10's team. Um, the thing about CS smoke, unlike just
947 the standard canister is, is that obviously the smoke bellows. It puts out a
948 tremendous volume of smoke, so you have that distraction I guess, but the
949 smoke will keep the particular of the CS crystals, which are micro crystals I
950 guess -- but it keeps it floating around inside versus just the CS. CS pops and
951 then falls to the floor quickly. But CS smoke in a combination, as the
952 smoke's generating in there, the smoke is also carrying the CS and keeps it up
953 off the floor from falling. So, X10's team went back up with two CS smoke
954 canisters. (Unintelligible) those, one into A, one into B.
955

956 Um, at 1421 X10 reported that both canisters were successful deployed --
957 window A, window B, and a steam ball was introduced. I don't know what
958 entry point that was. Um, 1422 X10 reported smoke coming out of the roof
959 vent, which was an indication that it was a good deployment. Started
960 checking with the parameter units for movement -- nothing, my guys all
961 reported they had nothing on the three side, nothing on the two side, and
962 nothing on the one side. And that's per 67, L23, and then this notes HCSO is
963 on the one side and there was no movement, nothing detected. Ah, some
964 more inner traffic, we emphasize that the teams maintain good observations.
965 That was -- during that time that was when, ah, (Cavinta) and I actually came
966 up here. We walked up from the MCC.
967

968 Man Up to the two (unintelligible) vehicles?
969

970 A Yeah. So at 1436 that when it -- we first started seeing a little bit of smoke.
971 Um, and I reported that to MCC -- that we had fire- had fire interior, mobile
972 surrender on the (unintelligible), notified the fire back here, and parameter is
973 1137...
974

975 Man Who'd you notify for that (unintelligible)?
976

977 A Um, I noticed a small amount of smoke coming from this room right here --
978 which would be the A port four side. Um...
979

980 Man Would that- would- would you describe that smoke as smoke from the
981 canisters, or does it...
982

983 A No it was different smoke, very- very, um, the smoke from the casters are
984 from the, er, from the- the gas smoke canister is all white. I mean, it's- it's
985 very obvious. The smoke that was coming from here was dark gray.
986

987 Man Okay.
988

989 A; Um, initially and it was a little bit. Looked like, ah, a smoldered fire...
990

991 Man Okay.
992
993 A That type of smoke. Um, we reported it, um, pulled the MCC -- (George) had
994 the MCC moved back. We got a (unintelligible) set up in front, after MCC
995 backed up. Um, had the, ah, fire ambulance crew -- we'd already staged the
996 (unintelligible) up close, um, brought the paramedics back but we kept the non
997 ballistic vest wearing folks back. Um, continued to see smoke, um, at that
998 point we went non stop continuous with (Farley) on the PA. You know he's
999 telling him, "Look, you need to surrender. We're now seeing smoke that
1000 looks to be fire. You need to come out." Um, that continued. We told him,
1001 don't stop, just keep it, continue it on from there. Ah, started getting reports
1002 from some of the others. They could see smoke. Um, no -- never really saw
1003 any flame though. I mean, it's like just smoke. And it, where is my -- here it
1004 is. Um, smoke continued to 1450. I reported we now had smoke coming out
1005 of A and B. Um, heaviest from A, and -- but we were start -- I was starting to
1006 see smoke coming out -- crawling out of B as well. And we started losing the
1007 (unintelligible). (Bishop), um, (Bishop)'s radio went down, still smoke from
1008 these. No change. No movement, 3 o'clock comes, the smoke is getting
1009 pretty heavy -- very heavy outta here, um...
1010
1011 Man That's A?
1012
1013 A Um, outta A. A little- a little bit more out of B, but the wind was blowing
1014 pretty hard. And, like I said, it was basically blowing north to south. But we
1015 weren't getting a lot of -- weren't getting any smoke reports coming out of the
1016 back here. So we didn't know if this may have been closed off, or what the
1017 situation was.
1018
1019 Man The hallway type of thing maybe?
1020
1021 A Yeah.
1022
1023 Man Okay.
1024
1025 A Um, at 1503 CDC calls in a report that they had side three window B smoke,
1026 which may have been up close, because those guys went up on the hill as far
1027 as I know, 89 who was covering side three, window B, banging inside. And
1028 that's when we started hearing either shots or rounds cooking off -- started --
1029 this definitely -- we still couldn't see flame, but this was pouring dark smoke.
1030 This was picking up good smoke and it was hot enough glas -- you know, the
1031 usual glass break, definite heat generation. Um, 1505 smoke intense, firing
1032 rounds cooking off, or shots inside and we had no way to tell. Forty nine
1033 reported that, ah, he heard bumping inside, side two, window B. 1507, 95
1034 who was over on this three side said that he could see smoke coming from the
1035 two three vent. Ah, X10 reported at 310, one four all along the roof, and we

1081 sounding board, but in essence he was the -- in addition to being the overall
1082 tactical commander, he was the incident commander on the scene. Um, I
1083 know it -- and I couldn't tell what time (Morry) showed up there, um, it
1084 towards the fire. So there was some other SO people, um, I know that
1085 (Cavinta) made at least one, if not more calls to the (unintelligible) sheriff.
1086 Um, but I don't know if he talked to the sheriff himself as well, or what. But I
1087 know that there was -- he had communication going with somebody back here
1088 in Eureka.
1089

1090 Man Okay, okay.

1091

1092 A Um, and that was pretty much all through the day. And especially, like once
1093 that fire started, then he was on the phone and on the radio, on the radio type
1094 of a thing. Um, you know it was his decision as far as where we were gonna -
1095 - where we were gonna introduce gas. Um, but yeah, definitely -- I mean we
1096 were game planning and strategizing, making sure we're covering bases, you
1097 know, what- where we were gonna go with this. Um, it was a mutually agreed
1098 upon decision though, that ah, unless he came out and surrendered we were
1099 not going to make entry. And that was from the get go. Ah, no team
1100 members were never gonna make an entry on this.
1101

1102 Man Okay. And Bill you've been referring to a log and I- I -- can we get a copy of
1103 that eventually?
1104

1105 A You can. That is my tactical dispatch (unintelligible) of dispatch, handwritten
1106 dispatch log and, ah...
1107

1108 Man And also...

1109

1110 A Paperwork.

1111

1112 Man You gave me -- we'd started off with these little sketch things that we made.
1113

1114 A Yes.

1115

1116 Man You wrote on one, but you'd also prepared one that you'd copied.
1117

1118 A Yeah.

1119

1120 Man Can you sign those for me please?
1121

1122 A I can. And I'm call the time on it -- basically at 230.
1123

1124 Man And Bill, um, how much was CDC tactical team involved in all- all this?
1125

1126 A Um, we had the initial CDC guys show up, um, they pretty much all stayed
1127 right there at the CP area.
1128
1129 Man Right.
1130
1131 A Um, and then they had some follow on tact guys that showed up -- and like I
1132 said, you know I was out here with the scene or in the MCC for the most part,
1133 but I don't recall ever actually putting them out on the parameter. For the
1134 most part we asked them to kind of basically maintain security around the
1135 MCC and the CP area, because we had some family people that were up there.
1136 There was a couple of incidents look- looking kind of folks that came down
1137 and were causing some disturbances. Um, so to my knowledge that's- that
1138 was the gamut of the area that they were offering. Some of em, ah, went and
1139 staged -- walked probably mid way, never came on -- to my knowledge never
1140 came all the way up to this team's, um, location. You know, came up the
1141 road, they could some smoke coming up over the hills, but I don't think...
1142
1143 Man Never seem to pass close enough to actually get a visual...
1144
1145 A Even on the house.
1146
1147 Man Okay. And you stated all- all the rounds that you guys put in there, were the
1148 CS rounds?
1149
1150 A All CS.
1151
1152 Man Okay.
1153
1154 A That's all we have.
1155
1156 Man Okay. Um, as far as the use of the gas, you pretty much (unintelligible), but
1157 with the wind and once it got -- the windows got open, it- you- you feel that it
1158 wasn't very successful because of that?
1159
1160 A No, not at all. I think it, ah, probably cut the effectiveness by 50% or more.
1161 That's why we continued to introduce gas, um, on both ends, and then the
1162 one- one side. Um, it was a strong wind, and I mean it was pretty obvious at a
1163 couple of points that that stuff was just -- it was blowing right through. Not to
1164 mention we had a number of rounds that were fired off that -- on that two side,
1165 and the three side that never made it due to the distance, and, ah, and the, ah,
1166 operational effectiveness at that distance of the system.
1167
1168 Man And, explain to me what this pyrotechnic is, non pyrotechnic- pyrotechnic?
1169

1170 A There -- the number of manufacturers, (Deptech) which basically makes all --
1171 we purchase from exclusively, there's (pyrotech), (pyrotechnic) -- they call it
1172 (pyrotechnic) and then there's (non pyrotechnic). Non pyrotechnic
1173 supposedly is sort of lab certified and manufacturer certified. But you could
1174 shoot that stuff in on, you know, gas impregnated sawdust and it will never
1175 heat up to a point that it would ignite. So it's safe regardless of what the
1176 furnishings are, or coverings on windows, excreta. Pyrotechnic usually
1177 involves something -- it isn't necessarily a- a flammable inducing, um, device
1178 -- either smoke or- or gas, it can be a fired round or a handheld, but what they
1179 were they refer to -- what the pyrotechnic refers to is the fact that the canister
1180 that hold whatever the content is, whether it be smoke, CS, CN, OC
1181 (unintelligible), or any combination thereof, heats up to an extent that there is
1182 a chance that it will cause a fire if deployed inside a structure.
1183

1184 Man Okay.

1185

1186 A That's- that's what pyro- pyrotechnic refers to.

1187

1188 Man And as- as far as you know SO wise, and you guys- you guys all use non
1189 pyrotechnic?

1190

1191 A To my knowledge that is all -- I know for a fact that's all my team had in use.
1192

1193 Man Okay.

1194

1195 A And to the best of my knowledge, that is all that was introduced by the SO
1196 team into that residence.

1197

1198 Man Okay. And, um, did- did you guys ever talk about using pyrotechnics at all?
1199

1200 A We discussed it, um, in one of the in one (unintelligible) -- what the pyro- the-
1201 advantage of the pyrotechnic, CS, is the fact that because it heats up it
1202 atomizes the CS or CN or whatever that agent is that deploying, it heats it so it
1203 like super atomizes it, and it keeps it in the air longer. They're normally
1204 recommended for exterior use only -- crowd control, ah, CDC, you know.
1205 Prisons use them all the time, and you see em tossing em and it's like this
1206 billowing cloud....
1207

1208 Man Uh-huh.

1209

1210 A That's- that's what happens when it seeps up in there, is that it just super
1211 atomizes the contents and creates a really good cloud that stays up rather than
1212 the non pyrotechnic doesn't. So you have larger particulate matter and it, you
1213 know, pretty much -- it drops to the floor. So, you know, unless you're down
1214 on your face crawling on the floor, you'd pick it up there but if you're

1215 standing up in a room, you know, you're gonna get some watery eyes kinda
1216 stuff, but the stuff doesn't hang enough at head level where it's supposed to be
1217 affecting your eyes, you know, there none of that kind of stuff. So that's the
1218 difference between a pyrotechnic and non pyrotechnic, ah, chemical agent.
1219

1220 Man Okay. And, um, as far as this fire that ended up happening, um, what would
1221 you think in your -- just in your mind, or your opinion, how- how that thing
1222 came about?
1223

1224 A You know initially, I thought he set it. Um, I there is a very outside chance
1225 that one- maybe one of the, ah, I don't think it was a 37, but maybe one of the
1226 handhelds -- because they will get warm to the touch -- don't get me wrong.
1227 The- the -- even the- the, um, 37s because of the (unintelligible) that have
1228 gone through. They get warm but you can hold em in your hand. Um, the
1229 handheld grenade type non pyrotechnic rounds, they get warm to the hand. I
1230 mean, they get pretty warm. They don't get, like, red hot. I think there's an
1231 outside chance it may have landed -- one of those may have landed on -- if it
1232 landed like on, um, cellophane, or something like that, I may have been able
1233 to conduct enough heat to get that to smolder, coupled with the amount of
1234 wind that was blowing through there, because I'll tell you, quite frankly,
1235 especially after the fire started, um, you know, this was a wind tunnel going
1236 on. Um, there may have been enough oxygen flow to get something ignited --
1237 maybe not ignited, but started smoldering and with the continuous wind
1238 blowing on it, that's how it started.
1239

1240 Man Okay.

1241
1242 A But initially, you know I- I didn't have a lot of doubt about the fact that he set
1243 that fire intentionally. But, you know, in 20/20 hindsight, I- I think there's an
1244 outside chance that one of those may have landed on something that just, you
1245 know, with the combination of factors, you know, the wind being probably the
1246 big one, and the fact of that house being ported out, so you- you know
1247 basically had this wind tunnel effect going, that it was hot enough, and
1248 whatever it was on, you know, it was just thin enough I guess, to be able to
1249 pick up just enough heat to start smoldering, and with that wind, start a small
1250 fall. And then it just continued to blow through there and fan the flames, so to
1251 speak.
1252

1253 Man Okay. And in- in your opinion Bill, I mean, is there anything else you- you
1254 guys think you could have done on it, or any more opportunity you could have
1255 given to, ah, () to- to come out?
1256

1257 A No, not at all.
1258

1259 Man I mean, we know that you couldn't get any closer, and on (unintelligible) from
1260 the intelligence that you had that he was pretty well armed if you got into that
1261 space.
1262
1263 A Yes, absolutely.
1264
1265 Man Um...
1266
1267 A Even if we didn't get into the space, just with what he had there that we knew
1268 that he'd fired, so we figured, you know, according to the intel that I got
1269 through the MCC, was you're gonna get -- he had the 22 available to him, and
1270 ah, probably a box or better of- of 22 ammo.
1271
1272 Man All right.
1273
1274 A So you know you're talking somewhere between 50 and 100 rounds.
1275
1276 Man Right.
1277
1278 A Um, just that alone, if you ever got in the gun safe, is more than enough to- to
1279 keep me from ever looking at ever wanting to put someone up there, because,
1280 um, the long and the short of is -- we don't have any armored vehicles
1281 available to us. And that was the only- only option -- if we'd had it, that we
1282 would have used and could have that. My staff, you know, I mean both teams
1283 have ballistic shields and CDC (unintelligible) ballistic blanket. The issue is,
1284 is that those pieces of equipment are great, but they're only 3A rated -- just
1285 like the vests that those guys are wearing, it offers a little more protection for
1286 the legs. But to rifle fire -- they won't stand up. They stand up to the- the 3A
1287 level, so you know you're talking handgun rounds. Um, if he had something
1288 more than that 22, which was confirmed, ah, in there that he had at least a
1289 large caliber -- and they said large, so, you know, figure 44 or -- who knows.
1290 Um, but at least a 44 sized handgun in there, that's risky as hell. And, ah, you
1291 know the only -- like I said, the only- the only option -- if we'd even had the
1292 availability of it, and we didn't and don't, is ah- is ah, armored personnel
1293 carrier or vehicle that, you know, the teams coulda used to safely get up close
1294 enough, then we coulda, you know, been -- I mean shit, we could have gone
1295 the whole -- and that actually was our initial plan until that fire started -- was
1296 that, um, we'd already put a call, er Lieutenant (Cavinta) had already put a
1297 call in to the FBI SWAT in San Francisco, made a formal request for them to
1298 go up their chain to bring both of their APCs up here because we were looking
1299 at another evolution period. We were -- the plan was- is that at 5 o'clock we
1300 were gonna do a complete turnover of CDC tact team on the inner parameter
1301 just in a hold situation. And both my team and the SO was gonna pull all the
1302 way out, go get actual bedtime and some meals, come back at 700 and ideally
1303 at that time, or shortly thereafter, we would have FBI up with, ah, with at least

1304 the two APCs and maybe some other resource so that we can get in closer,
1305 you know, and maybe open up some more voice to voice over a PA at a closer
1306 distance. Um, the APC would afford us the opportunity that we could have
1307 deployed a- a throw phone without jeopardizing the safety of the officers on
1308 the scene. Um, I mean we -- that would open up a lot more doors. We didn't
1309 have the resources.

1310

1311 Man Right. And how- how many you guys (unintelligible)?

1312

1313 A I've been in SWAT for 18, 19 years.

1314

1315 Man In that 18 or 19 years have you ever seen, um, a circumstance like this where
1316 you shoot gas into a house and no one comes out?

1317

1318 A Yes.

1319

1320 Man So that's not odd for that to happen?

1321

1322 A No.

1323

1324 Man Okay.

1325

1326 Man I got a few questions for ya. Um, you talk about the rifle teams and the
1327 SWAT teams...

1328

1329 A Uh-huh.

1330

1331 Man Can you tell me what's the role of the- the rifle team members are verses the
1332 SWAT? Is it different, do they dress the same?

1333

1334 A Um, our rifle team members for the most part dress in black. We had one
1335 team member that was dressed in our SWAT ODs. Um, but our tact rifle
1336 personnel attend the majority of our SWAT training. The difference is there's
1337 my SWAT team is -- goes through a SWAT school to get certified through
1338 post. They come back -- they're certified to do dynamic entries, to do entries
1339 into a residence, be the lead on that, that's basically the difference. The
1340 tactical rifle folks are a direct support element -- normally what I do is that I
1341 use them for my, ah, inner parameter containment because they have the
1342 additional training, and usually trained on some other systems, (unintelligible)
1343 aren't. Um, and the designated tactical rifle folks are also, um, given a hell of
1344 a lot more training in basic tactics, um, and more (unintelligible), or whatever
1345 you wanna call it -- I don't care. But they trained with us at a minimum of
1346 six- six training -- six months out of the 12 months that we do training in a
1347 year -- at a minimum. My guys -- I think I only have one guy that's ever
1348 missed one training. Um, they operate in a direct support role to us. If we're

1349 gonna do like, for instance, a structure entry, um, my guys are tasked --
1350 they're basically the point of the spear. Those tactical rifle folks are trained in
1351 direct support, so what they would do is they trail that entry team, and the
1352 areas that have already cleared -- they'll hold those rooms and provide
1353 security in em. If there are prisoners, they get passed all the way back into
1354 those cleared areas. My tactical rifle folks -- their job is to hold those people
1355 in a safe area. Or if it's a structural we're not entering, they handle the inner
1356 parameter containment, my team acts in an arrest or react team mode. If they
1357 have to do an exit and entry, or if there's a, you know, a- a voluntary, ah,
1358 surrender, then the SWAT guys are the ones that are actually gonna lay hands
1359 on and do the physical arrest -- tact guys are just direct support.
1360

1361 Man What is -- you said this but (unintelligible) a grenadier? Is that your...
1362

1363 A Grenadier is a chemical agent's certified person, whether they in instructor
1364 level, or a user...
1365

1366 Man And you have two...
1367

1368 A Actually I have three. I had two on the scene with me.
1369

1370 Man Two on the scene, and those are again?
1371

1372 A (John) and (Altic).
1373

1374 Man And, also you said that, while you're watching this house that, um, Mr.
1375 (██████████) never really said anything? Did you hear anything that -- at all, I
1376 mean, did you -- any sounds?
1377

1378 A In the point of time -- in- in the- in the amount of time that I was up at, ah,
1379 X10s position (Cornell)'s position up by the Expeditions, the only thing I ever
1380 heard were rounds either being fired or cooking off, and I'm just gonna
1381 assume that they were probably cooking off. Um, some glass breaking from
1382 the heat, but I never heard voice one coming outta there.
1383

1384 Man And for any of that time period when you were, say, at the command post, at
1385 rig...
1386

1387 A Never got with the...
1388

1389 Man Did any of your guys report to you any sound or anything unusual...
1390

1391 A Not during the fire at all.
1392

1393 Man You talked the- the (unintelligible) you talked with, ah, tact, um, was that
1394 about some tactical options?
1395
1396 A Uh-huh.
1397
1398 Man Negotiations? Were any of the EPD people involved with any of those
1399 negotiations, specifically...
1400
1401 A Serge...
1402
1403 Man PA staff or...
1404
1405 A Tactical planning...
1406
1407 Man When you were trying to make contact?
1408
1409 A No. No not as far like trying to make negotiation contact, no.
1410
1411 Man Any other involvement in- a- in regards to negotiations?
1412
1413 A No, none at all. Like I said, (Howden) and- and (Eddie) were up there during
1414 that night, but, um, they were never on a PA, never attempted it because-
1415 because of the darkness we didn't wanna initiate, or try to initiate a surrender
1416 command or negotiations, because it was just -- I mean they were holding the
1417 parameter and it was blacker than a coal mine in there. Um, none of my guys
1418 ever were in a position or tasked to do that.
1419
1420 Man You answered some of these here -- another one is, the 37 millimeters, those
1421 are single launch, 37 millimeters?
1422
1423 A Yeah.
1424
1425 Man What is that?
1426
1427 A It's one round at a time. They're single shots, single rounds, one round at a
1428 time, so they have to...
1429
1430 Man And where fired from?
1431
1432 A They're breach loaded. Um, so, they fired -- you have to pop the breech open,
1433 extract the expended round, put in a new round and close it back up, and then
1434 fire the next round. Um, the launchers, the SO's team has a multi launcher,
1435 ah, it's commonly referred to as an R1, but there's a number of manufacturers.
1436 They are a six shot revolving, ah, cylinder launcher, but theirs is 40
1437 millimeter. And the -- the difference being that a 40 millimeter cartage is

1438 about yea long and a 37 is about that long, and so -- but usually most of the
1439 multi launchers, ah, (unintelligible).
1440
1441 Man At some point you talked about the handhelds that were used?
1442
1443 A Uh-huh.
1444
1445 Man What the- an effective distance just to get it in there (unintelligible). That is
1446 thrown? (Unintelligible).
1447
1448 A Yeah, they're hand deployed. They're hand deployed and they can be
1449 deployed, um, there's actually an attachment for a 12 gage shotgun, but that's
1450 in an exterior because you can't aim it -- it's- it's a -- put the but of the
1451 shotgun on the ground and- and launch it -- that's in a crowd control open air
1452 setting. Um, now minimum -- there really isn't any minimum or maximum
1453 distance because they're hand deployed. I mean it depend -- all depends on
1454 how big the opening is they'd be trying to put it into -- or if you'd even wanna
1455 it -- and I mean do you wanna put it just out (unintelligible). But for this
1456 circumstance, they had to get down close -- probably within 10 feet.
1457
1458 Man That's all I have. Bill is there anything that, ah, we haven't asked you about
1459 the whole incident that you think is important for us to know that you can
1460 remember?
1461
1462 A No, um, not really. I mean there was -- the- the one thing that, ah, Lieutenant
1463 (Cavinta) and I were, ah, adamant about for the safety of anybody involved,
1464 and that was pretty close from point A on to the very end, was the fact that
1465 neither team was ever gonna make entry to that residence. Um, and he was
1466 either gonna come out, and then once the fire started, um, we reaffirmed with
1467 each other that we were not going to commit a team to go in after him, and
1468 that either we'd do everything as far as, you know, doing the PA
1469 announcements for him to come out. But unless he came out to surrender, he
1470 was making the choice to stay inside and we were not putting anybody in
1471 there and we weren't bringing anybody up until we felt safe enough to bring
1472 in (unintelligible) people and unvested people up. And that was a joint
1473 decision made by the both of us.
1474
1475 Man Okay. All right we'll end the interview at 1951 hours.
1476
1477
1478 This transcript has been reviewed with the audio recording submitted and it is an accurate
1479 transcription.
1480 Signed _____

HUMBOLDT COUNTY SHERIFF'S DEPARTMENT

CASE: 200703162
INTERVIEWER: Rich Schlesiger, Detective
SUBJECT: Attempt PC 187/ Officer Involved Shooting
STATEMENT OF: Brian M. Taylor, Deputy Sheriff
DATE & TIME: June 20th, 2007 @ 1540 hours.
LOCATION: Hoopa, California

ALSO PRESENT:

RS Rich Schlesiger
BT Brian Taylor.

RS Okay lets see here date is June twentieth (20th) two thousand and seven (2007), time is fifteen forty (1540) hours. Case two zero, zero seven, zero three one six two (200703162). Brian with an "T" right Brian?

BT Yes.

RS Middle initial?

BT "M"

RS Taylor. Pin number?

BT Thirteen seventy seven (1377).

RS Okay. Uh Brian what, I'm going to record us if that's okay with you?

BT That's fine.

RS Okay. And I, I need to talk to you a little bit more from what I understand there was a transaction between the C.D.C. guys, SWAT guys, and maybe Barney and Quenell?

BT Correct.

RS What I'm trying to figure out is what uh entailed that um, that whole transaction, okay?

BT Okay.

RS Since you had a Representative before [REDACTED] that uh would you like to have a meeting with all three (3) of us together or are you fine just talking like this over the phone?

BT No I'm fine without him.

RS Okay. So going back to the third (3rd) or it would have been the fourth (4th) that day, from what I understand you, Jesse Taylor, Bryan Quenell, Jamie Barney and Blake Massaro are down um at the vehicles, is that correct?

BT That's correct.

RS And eventually there is a vest that's brought to your guys' area?

BT Correct.

RS Okay and there's a transaction that takes place of the, of chemical agents?

BT Yes.

RS Okay did you see any of that?

BT No all I saw was uh the C.D.C. the guy who appeared to be in charge of their team, brought the vest down and provided to us and um he talked with Quenell and Barney and uh they made a determination not to take the vest with them and only remove certain munitions from it to be deployed.

RS Okay and what do you know what was uh taken off of the vest?

BT No. I know that they chose to leave the pyrotechnics.

RS Okay.

BT (Inaudible)

RS What was that conversation?

BT Uh I just heard Quenell say I don't, we don't want to burn the house down.

RS Okay, did you see the pyro, not pyrotechnic, the uh, uh the gas that was given to those two (2) guys, did you see what it looked like at all?

BT No it was all in the vest.

RS Okay, but you didn't see an exchange or anything like that?

BT No he just uh, I believe he laid the vest down on uh tailgate and they removed some munitions from it and left the rest.

RS Okay. Did you see who, who equip themselves with those?

BT Uh Jamie Barney.

RS Okay and at that point did, is there any mention about pyrotechnics or anything like that?

BT I believe the C.D.C. guy said there was some pyrotechnics in the vest.

RS And was there any comments back at that?

BT Just that we didn't want to use pyrotechnics, we, just the comment that Quenell made that we, we're not prepared to burn the house down.

RS Okay. Okay and you never saw any of them that were on Barney, what they looked like or anything like that?

BT No that there, I was covering uh one (1) of the windows, I believe it was the 'B' window four (4) side, and when they went through the vest and took the munitions.

RS And Brian this would be on the second deployment of gas is that right?

BT Yes the second time we actually walked, physically walked up to the windows and deployed gas yes.

RS Okay. And when you guys walked up there um and the items were thrown into the "A" window first, I think there was one, one that was thrown threw the "A" window?

BT Yeah.

RS And was there two (2) thrown through the "B" window?

BT I believe only one (1).

RS (Inaudible).

BT I, I'm not sure the though I was um holding the blanket and looking away cause I didn't have any firearms,

RS Okay.

BT (Inaudible) if he came to the window.

RS Okay and did you, when, when that stuff was thrown in did you ever hear an explosion or anything like that?

BT Not that I recall.

RS Okay and um so you guys returned and obviously the smoke starts then, then so on is that correct?

BT Yes.

RS Okay and um was there every any mention Brian when you were down there about a hand ball?

BT I don't recall.

RS Okay. Do you know what a hand ball is?

BT Yes I do.

RS Okay and was there any mention about a stinger?

BT I believe I heard something to that effect.

RS What did you hear?

BT Uh that there was one (1) in the vest and then we were talking about deploying a stinger.

RS Okay. Did you say who, did you, can you recall who said something about the stinger being in the vest?

BT No it was ambient conversation; uh people talking back and forth, I couldn't say who said it.

RS Were you, were you pretty much covering the house while these guys are talking?

BT Yes. They, they were, those three (3) Quenell, the head C.D.C. guy, or the man in charge there with the mustache, I don't know his name and Barney were talking and I was doing other things, their backs were to me.

RS Okay. And you never saw what any of these things looked like?

BT No.

RS Okay. Have you ever seen a stinger grenade uh set off?

BT Uh yes.

RS And there's, is there an explosion when that happens?

BT Uh there's a separating sub-munition, yeah I guess you'd call it an explosion.

RS I mean you can hear it sometimes or?

BT Yeah.

RS Okay and balls fly out of that thing right?

BT Correct.

RS Okay. Um and this team leader from C.D.C. do, you said he had a mustache, what, can you tell me a little bit what, what he looked like?

BT I would say he's probably five ten (5'10") uh one hundred and eighty (180), to two hundred (200) lbs., kind of dark complexioned you know like a tan white guy.

RS Okay.

BT Uh was wearing sunglasses and appeared to be the man in charge; he was giving all the orders.

RS Okay. Brian when the vest comes back is there any more discussion about, about the vest?

BT What do you mean when it comes back?

RS When it comes, when you guys, well not when you come, when you guys come back is there any more discussion about the vest or what was thrown into the residence at all?

BT I, not that I recall.

RS Okay and you're one (1) of the gas guys for the SWAT Team?

BT Correct.

RS And were you ever consulted during this transaction about what was going to be thrown in to the house at all?

BT No.

RS It was mainly between Bryan and Barney the C.D.C. guy?

BT Yeah it was determined that Barney was going to be the one (1) to deploy the gas um so I was not involved in that portion.

RS And your portion was, was covering the pole, with the ballistic vest?

BT Right holding it up yeah.

RS Okay. And um so as far as you know the only thing that was thrown in at that time were those tri chambers?

BT As far as I know, I know definitely uh supposedly a tri chamber was thrown in the "A" window, I don't know exactly what was thrown in the "B" window.

RS Okay. And how, how did you know it was a tri chamber?

BT I just again from the, the guys talking, I did not physically confirm by, you know I didn't see it.

RS Okay.

BT I know it was shaped like a tri chamber

RS Okay.

BT It was a silver grenade.

RS Okay and you never saw anything that looked like a ball at all?

BT No but I didn't see the second munition at all.

RS Okay. You were looking away at that time?

BT Yes I was facing uh away from the backside of the residence holding the blanket up.

RS What side were you on, what side was Blake on?

BT I was on the right side and Blake was on left.

RS Okay. Okay. Let's see here and but do you recall some talk about a stinger ball or a stinger grenade?

BT Something to that effect yes.

RS Okay.

BT Cause we, I remember them talking about throwing one (1) in there and would it be effective, um and just talk of that nature.

RS Okay. (Inaudible). Can you describe the vest a little to me, I, I got some pictures but since you're up there I was just going to see.

BT I it just looks like I, you know those uh typical raid vest with um uh myriad of pockets.

RS Okay was it black nylon?

BT Yeah something like that.

RS Okay and do you know what a handball looks like?

BT Yeah.

RS What's it look like?

BT Well pretty much like a stinger.

RS Okay is there writing on it, is it different colored?

BT Well usually all black, the one's I've seen are all black and it says H.A.N dash BALL uh and uh black writing on a white strip down the center of it.

RS Okay and what's the stinger ball look like?

BT Uh pretty much the same.

RS And what's written on that?

BT Um I believe there's writing on that also but it's smaller I couldn't say for certain.

RS Okay um and

BT I believe it says stinger actually.

RS Okay and, and Brian is a handball a pyrotechnic?

BT Yes.

RS Okay and a stinger ball, what is that classified as?

BT To tell you the truth I'm, I would have to research that, I'm not sure I believe it, it's uh um classified for indoor use.

RS Okay.

BT And it maybe a pyrotechnic but I believe you can use it, as an indoor pyrotechnic.

RS Okay kind of like the tri chamber thing.

BT Right.

RS Okay. Is there anything else Brian that I haven't asked you that you can remember that would be important about the exchange and all that that happened?

BT Not that I can think of.

RS Okay. All righty we'll end the interview at fifteen fifty one (1551) hours.

End of transcript.

Transcribed on 1/18/08 by [REDACTED] 0608.

HUMBOLDT COUNTY SHERIFF'S DEPARTMENT

CASE: 200703162
INTERVIEWER: Rich Schlesiger, Detective
SUBJECT: Attempt PC 187/ Officer Involved Shooting
STATEMENT OF: Bryan Quenell, Sergeant
DATE & TIME: June 20th, 2007 @ 1035 hours.
LOCATION: Fortuna, California
ALSO PRESENT: Steve Dunn D.D.A. Investigator.

RS Rich Schlesiger
SD Steve Dunn
BE Bryan Quenell

RS Okay day is June twentieth (20th), two thousand and seven (2007) time is ten thirty five (10:35) hours, case two zero, zero seven zero three one six two (200703162), we're at Sergeant Bryan Quenell's residence in Fortuna. Zero eight seven two (0872)?

BQ Mm hmm.

RS Good memory huh?

BQ Yeah you're good.

RS Uh present uh Detective Schlesiger and Investigator Dunn um Bryan we talked a little bit on was it Friday, last Friday?

BQ Yeah.

RS About um and I told you that C.D.C. has came back and said that in their inventory off that vest there was never a stinger ball or stinger grenade whatever they call it um on that vest and um what we're doing now is uh just clarifying uh what's, what the transaction was just of that with all you guys that were down there with the vest and all that, um and before you were (inaudible) represented by [REDACTED] is that correct?

BQ That is correct.

RS And um have, you've spoke to him?

BQ Yes I have.

RS And you have no reason for him to be present during this?

BQ No I don't.

RS Okay. Um going back to, it would have been the fourth of (4th) of June then, um how did the, a little bit more detail of how the discussing went on about what was going to be used in the house.

BQ Uh Lieutenant Cavinta was back at the Command Post and told me via the radio that uh he wanted us to start inducing the uh flameless C.S. canisters to the residence and that uh C.D.C. would be bringing down to me uh those items, he had also authorized myself to introduce uh the, they're called speed heat canisters as well if while we were introducing uh the chemical agents that uh if the [REDACTED] started firing upon us or made any aggressive acts towards us that we could introduce those as well. C.D.C. brought a uh tactical nylon vest down to my location, which was at the front vehicle and uh showed me what they had on the vest, which included the tri chamber flameless grenades, uh speed heat grenade, and their team leader who I don't know his name, pulled a stinger grenade off the vest, told me that uh it had thirty two (32) caliber rubber pellets in it uh, it was rated for indoor use, and that upon deployment of it, it would explode sending the rubber pellets into the room uh and also had a uh, a chemical agent in it as well, I don't recall if it was C.S. or O.C.

RS And the team leader, do you remember what he looked like at all?

BQ He was uh a shorter guy probably five seven (5'7") five eight (5'8"), um olive complexion, with a dark mustache.

RS And he, was he dressed in full SWAT gear?

BQ Yes he was.

RS Did he ever see his name or anything like that?

BQ I did not.

RS Okay. So he brings this vest down to you and this stinger ball he mentions, how, how does that become into your possession?

BQ Uh originally we had placed their vest on Deputy Barney um and he was going to deploy the munitions from the vest. I told him that uh I would prefer to have him take those items off the

vest that we were going to deploy so there was no uh chance of us accidentally sending in a canister that wasn't rated for indoor use. So Deputy Barney took the vest off, uh we removed the tri chamber uh, flameless uh C.S. grenades from the vest, placed them on Deputy Barney's person, and then uh we also removed the stinger from the vest and placed that on his person.

RS And is this before the first deployment?

BQ No this is the second deployment.

RS Okay. The first deployment was your guys or S.O.'s, flameless, flameless grenades right?

BQ Yes.

RS (Inaudible) the aerosol or whatever it is.

BQ The expulsion grenades.

RS Okay yeah okay, um so when you guys went up to the residence that I believe it was the 'A' window or whatever um who deployed the stinger ball into the 'A' window?

BQ The stinger ball was deployed into the "B" window.

RS The "B" window okay, okay it was "A" then "B" right?

BQ Correct.

RS And who deployed that?

BQ Deputy Barney.

RS Okay. When, when it went in there did you hear anything after that?

BQ Yes I did.

RS What did you hear?

BQ I heard it explode, and what sounded like rubber pellets bouncing all over the room.

RS Have you ever seen a stinger ball uh deployed before?

BQ Yes I have.

RS And did that seem consistent with what it was?

BQ Yes it did.

RS Okay. And when you were down there Bryan um when you were handed over the, the stinger ball, did you look at it or anything like that?

BQ I did not personally, I believe Deputy Barney did.

RS Okay, and um do you recall what it looked like at all?

BQ Uh it was round rubber grenade looking minutia, I mean we have them in our inventory, I've seen them before.

RS And are they, do you know what color the writing is on them or anything like that?

BQ I believe it's got a white band around the middle of it with black writing.

RS Okay um and so at that time, you're, you're thinking that you deployed a stinger ball?

BQ Correct.

RS And up to time until we talked a little bit on Friday about us needing to talk to you again, you had no idea but a stinger ball was deployed?

BQ Correct.

RS Um I've got some pictures here, the first one (1) is marked number one (1) and it uh a nylon vest with two (2) canisters in there, do you recall that?

BQ Yes that's the vest that C.D.C. brought down to us.

RS Okay. Do you know what those two (2)?

BQ Those look like the speed heat canister.

RS Okay and number two (2) it looks like it is a picture of a speed heat canister?

BQ Yes.

RS Can you see back here, it looks like someone's hands on a ball?

BQ Yes.

RS Do you know what that is?

BQ That no, it looks like a uh stinger ball or it could be a handball, I can't say for sure.

RS Okay and number three (3) here is I'm not sure if that was where it was left, the vest or not um in the back of I would say probably a tribal vehicle?

BQ Yeah this was the first tribal vehicle that was in that line and that is where we left the vest, um it never, once they brought it down and we removed, removed their munitions we never brought it out of the back of the ve, vehicle.

RS Okay, and number four (4) is a little blown up picture of number two (2) from where the hand is there on the ball and I don't know if you can make out any of what the writing is?

BQ That looks like it says C.S. and it looks like there's two (2) "L's" over here so it would be a handball.

RS Okay. And the two (2) items I'm going to show you or pictures, I'm going to show two (2), number five (5) is a hand ball and number six (6) is a stinger ball or just I think stinger is what it says, did you see either of those on the vest?

BQ Uh I believe it was a stinger that was given to us, um we didn't go through every pocket on the vest, like I said, I asked that uh just the stuff that was rated for indoor use be removed from the vest. I was never actually in possession of the vest uh that was between Deputy Barney and uh like I said C.D.C.'s team leader.

RS Okay, um have you ever um, the handball is uh, what's that used for?

BQ That's for outdoor use uh and it's a uh another way to deploy chemical agents.

RS Okay and is that, in that, does it shoot out a flame or does it?

BQ I don't think it shoots out a flame uh the only time I, I've seen it used is that video that I watched in your office uh and it looks like that it just uh shoots out gas,

RS Okay.

BQ And it, it doesn't have, have an explosion like the stinger does.

RS When you've seen the stinger go off, what's left of the casing?

BQ Nothing.

RS Nothing?

BQ No.

RS And um as far as you know, you guys, did you guys have stinger balls up there at, at the site?

BQ Yes we have some in our inventory.

RS Okay and as far as you know were any of those grabbed or anything?

BQ I don't believe so.

RS Okay and going back to the transaction between was it mainly you and the C.D.C. guy?

BQ I told him what I wanted, he brought the vest out and I told him specifically I didn't want anything going with our team as we made our approach that wasn't rated for indoor use.

RS Okay. Was there anybody else around you guys when that occurred?

BQ I believe my entire team was standing there because I was working on the plan to make the approach again, uh it was probably like I said Deputy Massaro, uh Deputy Jesse Taylor, Jamie Barney, uh maybe even Brian Taylor was standing there. C.D.C. at that point had uh assumed the cover position on the number four (4) side uh while we were gearing up getting ready to make out approach again.

RS Okay and so during that time, would it, was there any other C.D.C.'s guys around just besides the team leader?

BQ Uh there were some guys there uh I don't know any of their names and I don't know how close they were and I don't know whether or not they heard this happen.

RS Okay. Steve?

SD Just confirming Deputy Barney is actually the person that threw the, what you believed to be a stinger ball?

BQ Yes.

SD Um is there C.S. in a handball and a stinger ball, or just the handball, how, how does that work or do you know?

BQ I, I believe the stinger's can come either just with rubber, rubber pellets in it or with rubber pellets and C.S. or O.C. uh and as far as a handball doesn't deploy any rubber bullets at all, it is purely chemical agents only.

SD Got it. I think you answered the other one (1) I had, that's all I have.

RS Okay. Um so as far as you were concerned Bryan the, if you would have been handed that handball, you weren't going to use that at all?

BQ Correct.

RS And as far as you know, you were given the stinger ball and that's what Barney threw in?

BQ Correct.

RS Okay. I can't think of anything else.

SD I don't have anything else.

RS What about you Bryan, anything?

BQ That's it, I mean like I said uh I specifically asked for things that were rated for indoor use and the reason I wanted a stinger ball was because I was concerned that if he was in that main living area as we were gonna deploy gas again it would have given him an opportunity to shot at us again so I wanted that deployed first before we introduced the chemical agents to get him out of that area.

RS Was that told to the team leader?

BQ Yes it was.

SD Okay.

RS Okay I don't have anything else. End the interview at ten fifty eight (1058) hours.

End of transcribed.

Transcribed on 1/16/2008 by [REDACTED] 0608

HUMBOLDT COUNTY SHERIFF'S DEPARTMENT

CASE: 200703162

INTERVIEWER: Steve Quenell, Detective

SUBJECT: Attempt PC 187/ Investigation

STATEMENT OF: Chief Willie Hostler

DATE & TIME: June 3, 2007

LOCATION: Hoopa, California

ALSO PRESENT:

SQ Steve Quenell
WH Willie Hostler
UM Unknown Male

SQ Okay the following will be a statement from Chief Hostler from the Hoopa Tribe regarding the shooting incident uh on Pine Creek Road, the date is the third (3rd) of June, two thousand and seven (2007). Willie in your own words why don't you explain to me how you got the call today and what transpired um after you got the call.

WH Uh must have been a little after three (3), uh Hoopa Tribal Police Dispatch called me at my residence stating that uh Deputy Berry from the Sheriff's Department uh needed back up, up here at the [REDACTED] residence off uh Bloody Camp road, Bloody Camp road is off Pine Creek road, um stated that uh a [REDACTED] was pointing a gun at him and needed back up. Um our closest unit was on a transport at the time to, to county jail in Eureka, at that time I went to a full callout, told dispatch start calling officers out so we got a hold of originally is myself, myself started getting ready, uh Sergeant Guyer was called to come out. Officer Norton uh Officer Spallino and got a hold of Officer Roberts who was on transport to expedite back to the valley, um got ready, um got a status on him, Deputy Berry as I was leaving my residence, stated that he did move back about one hundred fifty (150) feet, two hundred (200) feet from the residence, but the subject was still pointing a rifle at him uh all my, I proceed code three (3) to up here to location. As I got on to the Bloody Camp road off Pine Creek I turned my lights and siren off um at that time Sergeant Guyer was behind, we proceed down the [REDACTED] residence off the Bloody Camp road, um got within about seventy five (75) yards of the residence, I saw somebody standing in the window uh south end of the residence um I could not make it out who it was but he was wearing a red shirt so we stopped there, we didn't want to proceed any far, into the residence because the driveway um goes left back into the residence within about forty (40)

Sergeant Guyer um made sure, I think we were talking to Deputy Berry and he believes that uh [REDACTED] was the only one (1) in the residence, he got everybody out of, in the residence um start talking to uh the incoming units, um Sergeant Miller was I believe was talking to us, saying we, we can't in coming units we had from Yurok or CHP and the Hoopa units to set up a perimeter so first one's on scene till after me and Sergeant Guyer, uh CHP Officer Nolan and uh two (20 units, one (1) unit from um Yurok Tribal Police, Sergeant McCovey I believe who was the, twenty four zero eight (2408) the new officer for them, so I advised them with my unit twenty five zero five (2505) who just got on scene too, to move to uh location um east of the residence which overlooks the residence to cover the back door, since the Deputy Berry had um covering the front door and we, from our location we could see the south side of the residence and so we got that up there in place, then at that time Sergeant Miller came in and was it briefed him on that then Deputy Taylor came in so from our vehicle uh for to observe a point uh Deputy Taylor, Matt Spallino just to cover you know to make sure that our location was safe. As more units start coming in um Lieutenant Cavinta was here uh, start talking to the family, the family was concerned um what was going on so,

SQ By family you're talking about the?

WH The mother of the, [REDACTED] [REDACTED].

SQ Okay.

WH Uh was talking to (inaudible) Cavinta and uh Deputy Mabry who was also here he got here um so they were, everybody was getting in place um they saw movement in the trailer from you know from you know different locations and he kept coming out then for about, for awhile he was coming out regularly then he didn't come out, out of the residence for about an hour, you know out of the front door, then they saw some movement in the residence then I don't think it was like a little after six (6), around six thirty (6:30) ish, he uh opened fire from the residence to, uh south of the residence, towards our units who where Deputy Taylor and um Matt, Officer Spallino from my department. Um I think he returned fire at least three (3) shots, to uh the bullets hit the front Ford Explorer where those two (2) officers were and one (1) bullet hit the back uh Ford Expedition and that's when I was Deputy Taylor returned one (1) fire and I was about the front vehicle seventy five (75) yards, I was probably about hundred (100), hundred and ten (110) yards behind that when I heard the shots and that's when I took cover.

SQ Okay so heard three (3) shots?

WH I, I heard I thought it was initially two (2) but as uh we got more briefed, talking to the front four (4) guys, they said it three (3) because,

SQ Okay. And after those three (3) shots, then how many shots did you hear?

WH After the three (3) initial shots, Deputy Taylor returned one (1) shot, returned one (1) fire.

SQ Do you know what gun, what type of gun he returned fire with?

WH Uh I think Deputy Taylor his duty issued uh two twenty three (223) AR.

SQ Okay. Was there any other shots fired at that time?

WH No, just the three (3) from the [REDACTED] and one (1) from Deputy Taylor.

SQ And about what time was that?

WH That's around eighteen thirty (1830), I think it was eighteen twenty eight (1828) somewhere around there, it was right around that time and,

SQ It was still light out though?

WH Yeah it was still light out you know, you know yeah except sun, the sun was up for the, didn't go down till at least nine (9) so we had plenty of daylight

SQ Okay,

WH You know.

SQ Now you had mentioned that uh he had shot uh Mr. [REDACTED] when he shoot his weapon, his rounds had struck a vehicle?

WH Yeah.

SQ What vehicle did?

WH They hit uh my unit which was seventy five (75) yards from the residence, uh Ford Explorer and hit two (2) shots to the windshield, I didn't see him but that's what I was told by the Officers, uh Deputy Taylor was on the left side of the vehicle, Ford Explorer and Officer Spallino from my department was on the right side, right side sorry, and Deputy Taylor was on the left side.

SQ Now is that a marked vehicle?

WH Yes marked vehicle yes.

SQ How is it marked?

WH It has uh stripping on the side that says uh Hoopa Valley Police and it has a light bar on top.

SQ Okay.

WH It's a clear two (2) inch and a half, two and a half (2 ½) inch wide light bar, clear.

SQ Okay. And where is that vehicle at now?

WH It's still parked up there in the driveway.

SQ Okay, um so that would be two (2), two (2), two (2) rounds from the,

WH Yes.

SQ What about the third (3rd) round?

WH The third (3rd) round is the unit behind me which is Sergeant Guyer's Ford Expedition has one (1) uh other shot in the windshield.

SQ Okay and is that a marked unit?

WH Yes it is.

SQ Can you described to me how that one (1) is marked?

WH It is marked uh with uh it says Hoopa Tribal uh Police Department on the side with a graphics detail and doesn't it's uh all the lights are internal, but it does have a white uh, uh spotlight on top.

SQ Okay now suspect fires three (3) times?

WH YES.

SQ Deputy Taylor returns fire?

WH One (1) shot yes.

SQ One (1) shot, then what happens?

WH Then basically everybody was taking uh cover then uh um move everybody back, trying to get them to fine you know, fine out where everybody was so we moved back you know, cause um to see, moved everybody back, we kept those guys in front where Deputy Taylor, we did move back a little bit you know to position by um, uh Sergeant Guyer's Expedition one (1) vehicle back then I stayed back to where, cause at that time Sergeant Miller said stay back, work on the diagram,

UM Hey Will, that creek at the bottom of the hill, Bald Hill, after you pass it where the slide is?

WH Mm hmm.

UM It goes up, that's not called Pine Creek is it?

WH That's Beaver.

UM Beaver Creek yeah. There trying to find where we're actually at on the topical graph, map.

WH This is, this is the Bloody Camp road.

UM Mm hmm.

WH Off, off the Pine Creek road.

UM Off Pine Creek yeah. I couldn't find it so I told [REDACTED] that I would come let you know and then,

WH I can go back in there after I'm done.

UM Yeah and see (inaudible) saved us some work, with me helping, trying to help them.

WH Okay.

UM Alright thanks.

WH Done with that so um, we get, everybody pulled back you know Deputy Taylor and those guys pulled, get them back a little bit then that's when um, just right after the shots rang out that's when the main S.E.T. Team got here, you know that's when,

SQ And what, and who's S.E.T. Team is that?

WH That's the Humboldt County Sheriff's Departments.

SQ Okay.

WH And um think out of the first one's (1's) is Deputy Ireland and Deputy Lundie, the first (1st) showed up but then, but the shots already went out so that's when they start getting their gear on, moving forward you know and then uh Deputy Bishop from the S.E.T. Team, that's when they, that the first one's I know of like that then the other um dispatchers, the tactical dispatchers here and they took over the log.

SQ Okay.

WH So but uh a little history on him on [REDACTED]

SQ Was there any other shots fired?

WH Oh, yeah oh then at uh about two (2) minutes before nine (9) I believe what, it sounded like one (1) but we were, we're roughly about, about one hundred and fifty (150) yards from the residence and we heard one (1) bullet about two (2) minutes before nine (9), you know more didn't sound like a shot, but it (inaudible) you could hear the bullet whizzing through the air you know (inaudible) you know.

SQ Okay.

WH That, that was then we heard um the S.E.T. Team open backfire back up. I don't know which members of the deputies um returned fire but it was at least five (5) six (6) rounds, we heard from the return fire.

SQ Okay. Have you talked to anyone uh as of yet, who had returned fire to confirm how many shots were fired?

WH No I never did talk to anybody because uh at that time I think they were talking to them but we started to move, we were bottling, everybody was bottle necked in, in on this driveway we start, at that time, when they were discussing who shot rounds you know.

SQ Mm hmm.

WH But they didn't say one (1) was uh Sergeant uh Quenell and I believe that there was two (2) others that did return fire but I didn't know how many rounds was officially, but it sounded like five (5) to six (6) rounds.

SQ Okay.

WH From my advantage point so I don't know if you want any other history on him (inaudible)?

SQ Well now after the shoots those shoots were fired what happened?

WH Those shoots were hired, were shoot um then that's when, at that time of the nine (9) o'clock the S.E.T. Team of five (5) members were gonna try to relieve Deputy Berry, uh Deputy Berry also had um Officer Landreneaux from the Yurok Tribal Police and at that time and also they had the civilian uh [REDACTED] was with them at uh, at um Officer Landreneaux's vehicle

so they were trying to get them out moving them out when that, the second (2nd) round at nine (9) o'clock came out so that's when then they moved um Deputy Berry and Officer Landreneaux out of the area and [REDACTED] went back up the residence who, up to my uncle's house, [REDACTED] residence to check on him, but he's fine in the residence, still in the residence, upper residence.

SQ So there hasn't been any other shoots fired since,

WH Nine (9) o'clock, no.

SQ Okay. Um why don't you go ahead and fill me if, whatever history you know about uh,

WH Well he's you know we've like we've arrested him for you know brandishing weapons in the past uh, um making uh criminal threats, death threats to other people you know minor, you know other minor things, you know we know that he's um, from the mother, he's making statements, we're done with him. In the past you know he is [REDACTED].

SQ And do we know whose residence he's currently in?

WH He is in, on the whole ranch basically my uncle cares, his ranch, you know it's all his uh head a cattle (inaudible) is [REDACTED] owns the property and owns the trailer who the [REDACTED] is in but the, the people that actually live in the residence are [REDACTED] live in the residence.

SQ And where are they at now?

WH They are down the road about a mile, on, on Translator road, they are safe and [REDACTED] is, is still in his house, upper house which is be about, two hundred (200), two hundred (200) about two hundred fifty (250) yards away from the [REDACTED] house so.

SQ We know for a fact that no one (1) else is in the residence with him?

WH (Inaudible) Yeah I'm pretty sure that's what [REDACTED] said that he was the only, when originally the call, when they called, you know they were trying to, you know usually they can call him down?

SQ Mm hmm.

WH You know they're friends around (inaudible) they try to help him out you know, I guess they had him laying down in the bedroom you know they figured, they thought they would get here but you know because of an extended E.T.A., I guess Deputy Berry and Officer Landreneaux were down in the Weitchpec area, like I said my unit was on a transport to Eureka,

the county jail so they were trying to keep him calm and you know he was already making statements, he didn't want to go back to [REDACTED] you know he doesn't like [REDACTED] so they were trying to keep him in there so [REDACTED] uh told [REDACTED] take her son, you know you just need to go, so they left so [REDACTED] stayed there and when Deputy Berry and um Officer Landreneaux showed up that's when um [REDACTED] you know he got excited, he got you know agitated, and that's when the whole situation went to where, that's when the guns, he went back in the residence, got a rifle or gun and pointed it at Deputy Berry and that's when, went to there. But a little history, he yeah he does like guns I know a few years ago I know we pulled off um S.K.S. off, off [REDACTED] he was firing it in the um, in the housing unit a few years ago you know that went to court, I don't know if what ever happened to it, what dispose of that case was but uh,

SQ What's his full name?

WH Uh it's [REDACTED] [REDACTED] uh [REDACTED] is [REDACTED]

SQ Do you know of any other weapons that are kept in that residence.

UM My, my rides here, some give me a ride.

WH Alright.

UM So I'll see you tomorrow.

WH Yeah.

UM Call, call me later if you need me.

WH Alright. Originally when the rifle was pointed at um, it sound originally that he had to have a hand gun, which we believe it's uh uh forty five (45) caliber um and the rifle but there was a, there's a gun safe in there but originally when the fire, shots were fired at six thirty (6:30)

SQ Mm hmm.

WH It did not sound like a twenty two (22), you know I've shot enough twenty two's (22's) to know the hear but it sounded, so it sounded like it possibly something bigger but the weapons are in the residence in the gun safe which we know, I think, we haven't confirmed but I believe I think he got into the gun safe but talking to [REDACTED] [REDACTED] earlier about ten (10) o'clock, he's saying that the bottom lock is the only one (1) that's locked on the gun safe. The gun, if you can take a crow bar or,

SQ Oh okay.

WH You can probably open it up,

SQ Sure.

WH get into it, which possibly he did, he knew, he knows about the gun safe, but in the gun safe there was an A.R. 15 (fifteen) with um two (2) twenty one (21) uh twenty (20) round magazines. So there is forty (40) rounds for the A.R. 15 (fifteen) also in the gun safe there's an S.K.S Assault rifle but uh there's no ammo for that, there is there's magazines for it but there's no ammo for it, but also in the gun safe there's a twelve gauge (12) shot gun which has about twenty (20) rounds for um for the twelve (12) gauge slugs, there all slug rounds.

SQ Okay.

WH Um for the forty five (45) caliber uh pistol, there's three (3) uh seven (7) round uh magazines so for that there is twenty one (21) rounds total. He doesn't know, he doesn't think, he can't remember if there was twenty two (22) rounds in the um in uh gun safe or not, he couldn't remember, but,

SQ Okay.

WH But it sounds like earlier that way he was pointing the gun, he was pulling the trigger at them, so we don't know if there was actually ammo, but there possibly can have ammo for the twenty two (22) which has a scope on it. So basically then there you know there's knives and that thing, but as the weapons that's the only weapons we know of.

SQ Okay.

WH But you know even though that I talked to [REDACTED] I think said that he did hear some rounds shots you know that six thirty (6:30) he said that didn't sound like a twenty two (22) to him either.

SQ Okay, so uh just uh re hashing what we've already talked about Willie, give me the, the, just the names of your personnel that's uh been here since the beginning?

WH Okay, initially got here I was you know, Chief Hostler, Sergeant Guyer, Sergeant Ed Guyer, Officer Mike Roberts, Officer uh [REDACTED] Spallino, were initially here, first (1st) one's here.

SQ Okay.

WH With uh you know Deputy Berry, from the Sheriff's Department, Officer Landreneaux from the Yurok Tribal Police then we had Officer Mike Roberts here from the Hoopa Tribal Police. Sergeant McCovey and twenty four zero eight (2408) from the Yurok Tribal Police and CHP Officer Mike Nolan um sixteen seventy two (1672) his call sign, then we had um Sergeant Miller and then Deputy Taylor and then I think uh Lieutenant Cavinta was here uh talking to the family when that, at six thirty (6:30) when those shots came out, and then right after the shots

rang out that's when the full SET. Team for the Sheriff's Department came in (inaudible) no all their names on the S.E.T. Team that were there.

SQ Okay, Willie is there anything else that uh you can think about that we haven't talked about?

WH Well just the, the incident on May twenty six (26)

SQ Mm hmm.

WH My officers were called out to um [REDACTED] uh mothers house uh [REDACTED] [REDACTED] house and uh Cal Pac road, on the south end of the Hoopa Valley for of [REDACTED] acting strange you know saying things, you know usually she can calm him down but she had to call the police this time because he was way out of control, and it sounds like from statements that she made on that day on the twenty sixth (26th) [REDACTED] uh I believe he [REDACTED]
[REDACTED]

SQ Mm hmm.

WH So they officers [REDACTED] you know he was making statements that you know he was untouchable, he can't be killed you know he's um, people been trying tot kill him by pointing lasers at his head you know he's was saying that he was um making wine but I guess what he did was he found gasoline and he was taking uh um other chemicals you know cleaners and Drano and was making a cocktail out of, what that's what why the mother called too you know he was just really out of it more than usual.

SQ Mm hmm.

WH So they took him [REDACTED] um took him to [REDACTED] on the way out you know he made statements you know he was un touchable, he likes to drink gas you know, um he's already dead you know so he doesn't care anymore you know call himself a coyote zombie, which has nothing not to do with Native American, he's a Native American but it has nothing to do with it but he's just you know delusional making those kind of statements you know but,

SQ Does he uh, does he abuse uh or utilize any type of narcotics?

WH [REDACTED]
[REDACTED]

SQ Okay.

WH Which we, talking to her in the past plus on the twenty sixth (26th), May twenty sixth (26th) she stated that [REDACTED] which is consistent what's that now?

SQ [REDACTED]?

WH Yeah [REDACTED] yeah um uh then they took him, then you know we uh requested [REDACTED] but I guess he uh during the time he was there, he uh felony vandalized [REDACTED] then Eureka Police Department was called and he was taken to the county jail and from there I don't know what happened, I guess um he was there for a couple days or a day and was released after um D.A. declined to press charges on him or make a case so,

SQ Okay.

WH And then that's when from the twenty sixth (26th) I don't know day he got home, but um he uh made it back to Hoopa, then he uh, this morning we received calls from, from the [REDACTED] residence again that he was possibly in an up roar again you know his uh,

SQ [REDACTED]

WH (Inaudible) [REDACTED], he hasn't been, I guess sounds like [REDACTED] [REDACTED] he vandalized the whole place,

SQ Okay.

WH So he, I don't know if he tore camera's off the wall but you know then they did not help him in any way, [REDACTED], so yeah [REDACTED] from what mother said telling the officers this morning, Officer Mike Roberts was looking for him you know uh went to the residence, talked to her, telling her concerns you know whereas um try to locate him at three (3) or four (4) difference residence, found some people he might have been with?

SQ Why was he looking for him?

WH [REDACTED]

SQ Just a welfare check on him.

WH A Welfare check on him basically cause the concerns of the mother saying that he was a more, same way, he was in the same condition that he was on the twenty sixth (26th) of May.

SQ Okay.

WH So they were looking for him all over town, found some people said no, he got a ride somewhere else, so he kept checking and before then that when he got an arrest about one thirty (1:30) I think the initial call, I don't know if it was ten (10) that came in AM. and he looked for him couple hours at different locations, you know tracking people down, go in the house, oh you just missed him or I don't know where he is you know so,

SQ How did they find out that he was up here?

WH Initially got a call from I don't know if it was the mother or but initially um then he goes uh [REDACTED] called and said that needed to get up here cause they couldn't him, usually they can handle him.

SQ Okay so they were actually at the residence with them and then?

WH With them yeah and they were trying to,

SQ He got out of hand,

WH Yeah basically,

SQ Then they left.

WH They left, well yeah he, well at the time they were all there, that's when I think [REDACTED] told him you need to get, need to get my son [REDACTED] out of here you know.

SQ Okay

WH So he stayed there you know so he thought that we were gonna be here fast,

SQ Mm hmm.

WH Cause he kept him in the bedroom, he had them laying down,

SQ Okay.

WH So then but by the time he got you know hey what's going on you need to stay in there and just relax and what's going on and he kept trying to figure out what was trying to go on that's when [REDACTED] told me earlier that he, the time when Deputy Berry did show up that um, um came in and you know by that time [REDACTED] was already agitated and that's when he saw him, supposedly I don't know where he found the knives (inaudible) picked the knives up from the kitchen or somewhere anyway he walked out and said these people just want to talk to you, you know [REDACTED] and he started putting the knives in his,

SQ And that was after the deputies had arrived?

WH Yeah he saw the deputies and that's when Deputy Berry told him I think I just want to talk to you and that's when it went you know went sour from there, that's when he, they saw him put knives in his pants and socks you know he was you know

SQ Okay.

WH Then that's when he went back in the residence to get the rifle, but yeah, but uh after the second (2nd) shooting, after nine (9) he, I came back up here to the command post and I talked to the mother cause she wanted to talk to me cause she thoughts you know that, she was trying to explain to me, you need to pull all the guys, I said this uh you know I said this um, um this incident is being run by the Sheriff's Department now and the Tribal Police is basically in a supporting role you know.

SQ Mm hmm.

WH I have I can talk to the people who are in charge, but there' the one's that are making the decision you know, they let me know what's going on and I advise, she's like you guys are the one's that your agitated him anyway. I don't' know who said it but she, what she told me was that he um that the unit, first unit responding came in with their lights on,

SQ Mm hmm.

WH Code three (3) you know, was on this uh P.A. system, that irritated him but,

SQ Okay.

WH But I can't confirm that or not and then I didn't want,

SQ Okay.

WH And then initially when I saw Deputy Berry I didn't talk to him because

SQ Sure.

WH he at that time was going to be debriefed by Sergeant, I mean uh Detective Schlesiger so but that's what the mother told me, you guys irritated, you agitated him, I wanted to talk with him originally, you know I can talk him down, you guys wouldn't let me talking to him you know.

SQ Okay.

WH You know she expressed her concerns.

SQ Is there a telephone there?

WH No he has not telephone to the residence.

SQ Okay, is there anything else that you can think of Willie?

WH No that's pretty much,

SQ Okay uh we'll end our taped statement here at twenty three fifty two (2352) hours.

WH Okay.

SQ Uh my name is uh Deputy, correction Detective Quenell.

WH Okay.

End of statement.

Transcribed on 8/22/07 by [REDACTED] 0608.

1
2
3
4
5
6
7 **INTERVIEW WITH DEP. JAMIE BARNEY**

8 Q=Det. Schlesiger
9 Q1=Inv. Steve Dunn
10 Q2=[REDACTED]
11 A=Dep. Jamie Barney
12

13
14 Q: Okay. The date is June 7, 2007; time is 1034 hours. Case 200703162. Uh,
15 we're in the Sheriff's Office conference room with Deputy Jamie Barney. Uh,
16 present is Detective Schlesiger, Investigator Dunn, and Jamie's Representative
17 [REDACTED]. Um, Jamie what's your middle initial?
18

19 A: Si - S.
20

21 Q: B-A-R-N-E-Y?
22

23 A: Correct.
24

25 Q: And your PIN number?
26

27 A: 1054.
28

29 Q: How do you spell Jamie?
30

31 A: J-A-M-I-E.
32

33 Q: And it - Jamie, uh, we're involved in doing the Critical Incident Response
34 Team, the CIRT Team, on an officer involved shooting and, uh, what had
35 occurred up there on (Bloody Camp) Road. Um, I want to show you this here
36 first. This is gonna be kind of - to just to help you. It's a little sketch that we
37 did to kind of help you place everything and all of that.
38

39 A: Mm-hmm.
40

41 Q: Um - and how long have you been with the sheriff's department now?
42

43 A: Mm, almost nine years.
44

45 Q: Okay. And, um, was some of that time in the jail?

46
47 A: Six years in the jail and three as a deputy. Yeah, two, and then about a half a
48 year in the academies.
49
50 Q: Okay. Um, and are you a member of the special enforcement team?
51
52 A: I am.
53
54 Q: Which is also a SWAT Team?
55
56 A: Yes.
57
58 Q: And how long have you been a member of that?
59
60 A: Since March.
61
62 Q: Okay.
63
64 A: February or March.
65
66 Q: Okay. And have you received any training to become a SWAT Team
67 member?
68
69 A: Yes, I went through the two-week SWAT school down in Sacramento area.
70
71 Q: Okay.
72
73 A: Or, (unintelligible).
74
75 Q: Huh?
76
77 A: (Unintelligible).
78
79 Q: (Unintelligible)?
80
81 A: Mm-hmm.
82
83 Q: Okay. And, uh, are you, um – do you have a specialty with the SWAT Team?
84
85 A: I was, uh, also went to school for gas deployment with Armored Tech with all
86 of their equipment and was trained on all the – all the gas that they supply.
87
88 Q: Okay. When – when was that do you know?
89
90 A: Uh, beginning of April.

91
92 Q: Okay. Um, the dates we're talking about obviously are June 3 and June 4.
93 Um, what were – were you paged, were you called out at your residence?
94 How – how did this all begin for you?
95
96 A: No, I was coming to work...
97
98 Q: Okay.
99
100 A: ...I do a swing shift 4 o'clock in the afternoon. I got here and it -
101 (unintelligible) told me that this incident happened in (Unintelligible), and it
102 sounded to me like it was a cor – coincidence, so I called dispatch and was
103 informed that they hadn't paged (unintelligible), so I went home and got my
104 gear, came back, and met up with everyone else here.
105
106 Q: Okay. Did you work the night before?
107
108 A: I did.
109
110 Q: Okay. And got off at 2:00 in the morning?
111
112 A: 2:00.
113
114 Q: Okay. How many hours did you sleep?
115
116 A: Um, seven or eight.
117
118 Q: Okay. And, um, what it – obviously you got dressed into your SET gear and
119 all that...
120
121 A: Mm-hmm.
122
123 Q: ...and met with the SET Team here?
124
125 A: Correct.
126
127 Q: Okay. And eventually you – were you guys in a – did you guys have a
128 briefing or anything like that?
129
130 A: A very small one.
131
132 Q: Okay.
133
134 A: In the briefing room about what was going on.
135

- 136 Q: Okay. And what were you told?
137
- 138 A: Uh, [REDACTED] in the house, uh, they were doing a welfare check on him. Um, I
139 think they – I'm not sure if I heard at the briefing, but I eventually heard he
140 had some knives and family members were concerned and called law
141 enforcement. When they arrived he – he came out to the porch one or two
142 times with a rifle. One of the officers, um, I heard the rifle had a scope, went
143 back inside, um, and they were basically surrounding the area. I think he
144 came out a couple times while they're en route there.
145
- 146 Q: Okay.
147
- 148 A: So...
149
- 150 Q: And w – uh, who'd you ride up there with?
151
- 152 A: Uh, Deputy (Bishop).
153
- 154 Q: Okay. And, um, you guys arrived around mm 1830 hours?
155
- 156 A: I believe so. I'm not...
157
- 158 Q: Okay.
159
- 160 A: ...positive. Somewhere around there.
161
- 162 Q: Okay. And, uh, when you arrived there who did you meet with?
163
- 164 A: I think – I can't remember who was directing, uh, either (Miller) or Cavinta,
165 uh, someone was directing us into the driveway down the road and can't –
166 don't know exactly who it was.
167
- 168 Q: Okay. Did you hear anything about what had ha – what had occurred when
169 you arrived or just before you arrived, anything like that?
170
- 171 A: Well I know when we arrived there were a couple, uh, what sounded to me
172 like shots fired, cause we got out of the car and heard it, immediately ran to
173 the rear of the car cause I wasn't sure what was happening.
174
- 175 Q: Okay. Where – where'd you guys park at when you went down there?
176
- 177 A: On the driveway probably four or five cars back from the...
178
- 179 Q: Okay. And so as soon as you guys get out of the – the patrol unit you guys
180 drove up?

181
182 A: Yes.
183
184 Q: Okay. You guys heard – how many shots did you hear?
185
186 A: A two for sure.
187
188 Q: Two for sure?
189
190 A: Yeah we heard two pop-pops and...
191
192 Q: Okay. What – what did you guys do after that?
193
194 A: Well I ran to the rear of the vehicle, popped the trunk, got my, it was a rifle
195 out, charged it, and then started to gear up with the rest of the – we put the rest
196 of my gear on.
197
198 Q: Okay. And where did you eventually meet with – I, uh, I take it I – I don't
199 know who was exactly in charge at that time, was Sergeant Quenell in charge
200 at that time?
201
202 A: Yes he was.
203
204 Q: Did you go and meet with Sergeant Quenell?
205
206 A: Well he's ahead of us, and we kind of scooted up to the two vehicles there.
207
208 Q: Okay.
209
210 A: And – and met with, uh, Deputy Taylor was there, and I think, uh, (Hossler)
211 from I think (Hoopa Tribal).
212
213 Q: Okay. And who else was there, anyone else?
214
215 A: I think there was, but I can't remember exactly. I remember Taylor and
216 (Hossler) for sure, cause that's the side of the vehicle I went on. (Hossler)'s at
217 the rear and Taylor's at the front.
218
219 Q: Okay. And so at the two (Tribal) vehicles did you guys take up position
220 there?
221
222 A: We did.
223
224 Q: Okay. Can you write in your initials and everyone else's initials of kind of
225 where they were at?

226
227 A: Brian Taylor was at the doorway. (Hossler) was here at the rear. I believe
228 Sergeant Quenell came around to the front and he and Jessie Taylor was there
229 too.
230
231 Q: So on the driver's side there?
232
233 A: Yeah. Not sure which – if Jessie Taylor was ahead or behind Brian, but...
234
235 Q: Okay.
236
237 A: (Unintelligible) change. And I was right here and eventually, uh, Sergeant
238 Quenell asked, uh, (Hossler) to move back so we can move forward. We
239 moved up from there.
240
241 Q: Okay.
242
243 A: I think – there's some more people behind me, I think (Fulton) took...
244
245 Q: Okay.
246
247 A: He's one that came up behind me.
248
249 Q: Did Ha – so (Hossler) left after a little bit?
250
251 A: Yeah, he was – we were – we were crouched in there for a couple minutes and
252 then...
253
254 Q: Okay.
255
256 A: ...Sergeant Quenell asked him if he could move back towards the rear so we
257 can move forward.
258
259 Q: Okay. And Jamie what were you armed with at that time?
260
261 A: The, uh, my issued rifle I call it, an...
262
263 Q: Okay.
264
265 A: ...AR.
266
267 Q: Okay.
268
269 A: AR.
270

271 Q: And you – did you have your handgun and your...
272
273 A: I had my...
274
275 Q: ...(unintelligible)?
276
277 A: ...handgun and, uh, my AR 15 has a – a 40 millimeter launch on it too.
278
279 Q: Okay. And, um, so you guys are stationed there, do you, uh, uh, can you
280 visibly see the house at all?
281
282 A: Yes.
283
284 Q: Okay. And let me see, I can't really see here. You're right...
285
286 A: I was right here to start with.
287
288 Q: Okay.
289
290 A: And then...
291
292 Q: You all are by the – by the second....
293
294 A: Yeah and then when (Hossler) moved back I moved up to the rear of the – the
295 first...
296
297 Q: The first vehicle.
298
299 A: ...one.
300
301 Q: Okay. So you – you can see – and from what we understand now is this is a –
302 the drawings off a little bit, it was more cocked to you – towards you guys?
303
304 A: Yeah it was kind of...
305
306 Q: Slant a little bit.
307
308 A: ...(unintelligible). Yeah.
309
310 Q: And, um, do you see anything, hear anything from the house?
311
312 A: Not for – for a little while. I mean the – the couple shots right when we got
313 out, but there was nothing for a while after that.
314

315 Q: Okay. Um, after you guys arrived how long until there's attempts for
316 negotiations begin?
317
318 A: I'm gonna say that I believe it was Deputy (Daniels) and Sergeant (Fibbly)
319 were there within an hour.
320
321 Q: Okay.
322
323 A: And got on the – the PA there on the second vehicle.
324
325 Q: They were in by the second vehicle?
326
327 A: Correct.
328
329 Q: Okay. Was there any responses back, um, from the residence?
330
331 A: There were some, uh, what I call hoping and hollering, um, at one point from
332 there. I'm not sure if they were trying to talk to him, but there was a
333 distinctive, you know, "Come get me motherfuckers," and something to that
334 affect, but, you know, "Come get me," was definitely hollered while
335 everything else was kind of in more of a – a hooping and hollering, yelling.
336
337 Q: Okay. And, um, what – what goes on after that?
338
339 A: I think we – I ended up taking – I go up to the door. The door is open, and we
340 were rotating back and forth on holding cover at the door, cause we see both
341 his windows and part of the – a stairwell not to much on the number three
342 wall.
343
344 Q: Okay. And it's mainly up by the door it was – was you and Brian Taylor?
345
346 A: No, Brian Taylor where'd he go? He – I think, yeah, it was both of us that
347 were taking turns going on the – but he left eventually. I think he might a got
348 assigned to – I mean this a couple hours later to go...
349
350 Q: Okay.
351
352 A: ...around on another side.
353
354 Q: Okay. So things go on and there's hollering and that it – and eventually there
355 is shots fired?
356
357 A: Yeah that's a couple hours into it.
358

359 Q: Okay. Is there anything in between that time of him, uh, uh, I – I – I
360 understand that negotiations were still attempted and all that?
361
362 A: Yeah on and off.
363
364 Q: Okay.
365
366 A: I think every fifteen minutes or so I think they...
367
368 Q: Anything else going on...
369
370 A: ...with him.
371
372 Q: ...with the house or anything like that? Was the [REDACTED] inside during that
373 time?
374
375 A: I don't remember seeing him until he showed up at the window...
376
377 Q: Okay.
378
379 A: ...the first time.
380
381 Q: When he shows up at the window the first time who's behind here at the
382 (Hoopa) vehicle?
383
384 A: I'm – I'm at the door.
385
386 Q: Okay.
387
388 A: Toney Jones is on the passenger side. I think Sergeant Quenell is, um, behind
389 me, and Deputy (Massaro) was either behind the sergeant or in the general
390 vicinity.
391
392 Q: Okay. And, um, were you covering the house with your rifle at that time?
393
394 A: I was.
395
396 Q: Okay. And were you aiming it anywhere at that time or were you just
397 covering it?
398
399 A: Uh, covering and – and I marshaled between the opening of the – the car and
400 the door, end of the barrel.
401
402 Q: Okay.
403

404 A: Not resting in there, but...
405
406 Q: Okay. And from this location Jamie, um, you – you can see the number four
407 side A and B windows.
408
409 A: Right sir.
410
411 Q: Okay. How far would you say you guys were away?
412
413 A: Uh, well the EPD laser front, uh, we were estimating 75 yards and it was later
414 determined to be 65 yards away...
415
416 Q: Okay.
417
418 A: ...away.
419
420 Q: And, um, what happens then?
421
422 A: Well I remember I was crouched down, maybe even kind of up in – I think it
423 was Deputy Gomes said, “He’s coming to the window,” on the – on the A
424 window. And I looked up and saw a – a silhouette with what Toney described
425 as a club and that’s what it looked like to me. And he did something, he either
426 opened the window or he stood there for a minute. It looked like he opened it
427 to me, I’m not sure if he actually did or not, but shortly after that I heard two
428 of the same, uh, shots that I heard when I got out of the car, you know but the
429 same – same sound. Um, it – it – I didn’t feel the impact, but I heard rounds
430 coming, you know, almost kind of like the zip and it sounded like it ricocheted
431 off, um, I’m not sure who fired first, but I remember getting up – and cause I
432 had to come up a little bit to get a good, uh, aim at the window. Um, I
433 remember hearing Deputy (Massaro) saying, “Watch your, uh, watch your
434 rifle,” cause he thought it was gonna be aimed at the door. So I repositioned
435 that so I can get it out there. I hear a loud blast, which I later learned was
436 Sergeant Quenell over me firing. That made me kind of flinch for a second,
437 came back up, looked at the window – I believe I still saw a silhouette there –
438 fired two shots into the A window, that’s where my aim was at, reassessed,
439 didn’t see him anymore and...
440
441 Q: Okay. So you – you – do you – Toney mentioned something to you that he –
442 he sees a bat at first or something.
443
444 A: Yeah he said it looks like a – he’s got something in his hand, looks like a club,
445 or...
446
447 Q: Okay. And did you ever see a barrel or anything come out of the house or the
448 window or anything?

449
450 A: Yeah I saw something, but I can't say for sure...
451
452 Q: Okay.
453
454 A: ...it's a barrel. There was something – something, it was – it didn't look like
455 a normal barrel plus the window was kind a dark in the back.
456
457 Q: It's starting to get dark about that time wasn't it?
458
459 A: Yeah it was...
460
461 Q: Okay.
462
463 A: ...that's (unintelligible).
464
465 Q: So the shots go, you see a silhouette in the A window.
466
467 A: I do.
468
469 Q: Okay. And then you – do you have a s – do you line up your sights and have
470 a sight picture at that time in the window?
471
472 A: I – I did initially and then, uh, (Massaro) saying, "Watch your barrel – watch
473 your barrel," so I took my eyes off the window for a minute to look to make
474 sure I wasn't gonna shoot the doorframe. And that's when, uh, Sergeant
475 Quenell I believe fired, made me flinch for a second, came back up, got a
476 sight picture at that time.
477
478 Q: And you still saw the silhouette in the window...
479
480 A: I did.
481
482 Q: ...at that time? Okay. After that occurs, um – well before that oc – before
483 that – so you fired two rounds. Do you have any idea who else fired around
484 you?
485
486 A: Well I know...
487
488 Q: Brian.
489
490 A: Brian did for sure cause his – I – I felt, I mean it was very loud, especially
491 without the earplugs like we're used to. And I know to my right where Toney
492 was I heard shots fired also, other than that...
493

494 Q: Okay.
495
496 A: ...I didn't hear anything else.
497
498 Q: And, um, did you hear anything from inside the house once that happened?
499
500 A: No.
501
502 Q: No.
503
504 A: I mean I was told later that he went hoping and hollering to the rear, but I
505 didn't hear that myself.
506
507 Q: Okay. And did you guys maintain your position here?
508
509 A: It - yes.
510
511 Q: Okay. And were negotiations still attempted at that time?
512
513 A: I think they started up maybe not right afterwards but shortly after.
514
515 Q: Okay. And there was no response?
516
517 A: There might a been some moving, hoop and hollering ...
518
519 Q: Right.
520
521 A: (Unintelligible) ...
522
523 Q: Nothing that you can ...
524
525 A: Not - not any response to, um, I think who - (Daniels) wasn't there at the
526 time.
527
528 Q: Okay. And do you main that - maintain that position throughout the night?
529
530 A: On and off we rotated around, but primarily it was on the - on the door side
531 there.
532
533 Q: Okay.
534
535 A: We took turns with (MEG)'s and the stand and standing right to the side of
536 that and watching the house.
537
538 Q: Okay. Did you ever see where those rounds struck?

539
540 A: I believe at the end I saw where I thought the impact probably was.
541
542 Q: Okay.
543
544 A: That was never reaffirmed that that was the case or not.
545
546 Q: Okay. Um, so the rest of the – the night you guys are here is there anything
547 else that goes on around the house or with you guys just besides rotating
548 through or anything?
549
550 A: Well he's moving around. I mean we see him moving around the house, um,
551 you know, with (MEG)'s, it – it's hard to tell what he's doing but there's
552 weird light flickers, which you know could have been a fire or could have
553 been the TV, could have been a lot of things, but he does come to the window
554 a couple times with his flashlight and, um, I guess he's trying to – I don't
555 know if he's trying to shine it at us, but...
556
557 Q: So he was shining it out the windows...
558
559 A: Shining it out the window and at one point the, uh, the floodlights come on on
560 the corner there for a brief second, go right back off, and he turned some more
561 lights on and off in the – in the living room area there. I don't know if he says
562 anything. I think at least not – not that I ever hear.
563
564 Q: Okay. And you guys were there till very late in the next morning, that would
565 be now.
566
567 A: Yeah. I think it was I guess around 3:00 or so before...
568
569 Q: Okay.
570
571 A: ...maybe even later.
572
573 Q: And were you guys relieved by anyone?
574
575 A: Eureka.
576
577 Q: SWAT Teams?
578
579 A: SWAT Team.
580
581 Q: Okay. And, um, you guys, uh, where do you guys end up going from there?
582
583 A: The, uh, sub station.

584
585 Q: Sub station?
586
587 A: (Unintelligible).
588
589 Q: Did you get any sleep at that time?
590
591 A: Maybe a little cat nap of five minutes but nothing...
592
593 Q: Okay. Um, did you reload your, uh, long – long gun at that time?
594
595 A: No. No I – it stayed the same way at all time.
596
597 Q: Okay. And you guys had to be back around 6:00 am...
598
599 A: 6:00.
600
601 Q: ...wasn't it? Okay. When you guys came back up Jamie, um, and I – and
602 we'll – back to the night, you were taking direction from Sergeant Quenell at
603 that time right?
604
605 A: Right.
606
607 Q: And then Lieutenant Cavinta was, um...
608
609 A: Was in the...
610
611 Q: Command Post?
612
613 A: Right.
614
615 Q: When you come back, um, wh – wh – what is your p – where do you go,
616 who's your teams at that time?
617
618 A: I think we switched it up a little, cause Brian Taylor was – I – I went back to
619 the same spot, to the – the first car that – I remember is – I know Brian Taylor
620 (Massaro) and (Jessie Taylor) go back to the – with Sergeant Quenell.
621
622 Q: Okay.
623
624 A: Go back to the...
625
626 Q: Down here we put their initials as the number two-day.
627

628 A: Uh, Brian Taylor and (Jessie Taylor), (Massaro), then Brian Quenell and then
629 myself all...
630
631 Q: Okay.
632
633 A: ...(unintelligible).
634
635 Q: Okay. And you guys take a position in the same place as you were...
636
637 A: Yes.
638
639 Q: ...the night before?
640
641 A: (Unintelligible).
642
643 Q: Okay. Is there negotiations, uh, attempted still?
644
645 A: Yeah, I think the (CVC) guys come in and attempted -- it was around 8:00,
646 8:30...
647
648 Q: Okay.
649
650 A: ...came in.
651
652 Q: Okay. And is there, um, from your guys' vantage point anything going on in
653 the house at that time?
654
655 A: Nothing. No. Nothing aud -- audible, visible or anything?.
656
657 Q: Okay. During -- and -- during before you guys were deployed the second time,
658 um, was there anything mentioned in -- about a game plan, what the game plan
659 was?
660
661 A: At -- um, yeah, something else that we were gonna -- attempting negotiations
662 again, um if -- it's the -- the same as the day before. We started initiating, um,
663 you know, gas in the house to attempt to get him to come out.
664
665 Q: Okay.
666
667 A: If negotiations didn't work.
668
669 Q: Okay. And, um, did you -- you never moved from that location?
670
671 A: No.
672

673 Q: Okay. Um, and e – eventually is a the decision ever made to introduce gas
674 into the house?
675
676 A: Yes.
677
678 Q: Okay. Do you know who that w – decision was made by?
679
680 A: Um, I believe Lieutenant Cavinta and Sergeant Quenell.
681
682 Q: Okay.
683
684 A: I mean I – it came from Sergeant Quenell to me, so...
685
686 Q: Right. And the – and what did Sergeant Quenell tell you?
687
688 A: Let's see, we're gonna do our – our – I think the first operation was gonna be
689 five gas rounds in A and B window.
690
691 Q: And that was gonna be who – who – who were gonna – who was gonna be in
692 charge of deploying the gas?
693
694 A: It was, uh, myself and Brian Taylor.
695
696 Q: Okay. And, um, as far as gas guns what – what did you have?
697
698 A: Well I had the 40-millimeter on my AR but at – at that distance I didn't feel
699 comfortable using it. So we had the single shot 37-millimeter, we had two of
700 them.
701
702 Q: Okay. Are they – are they both just breach?
703
704 A: Yeah.
705
706 Q: Both of them (unintelligible).
707
708 A: One was – one was quite old that we didn't even try to use it so we used the
709 newer one.
710
711 Q: Okay. So it was one guy at a time and not both of you?
712
713 A: Correct, yeah.
714
715 Q: Okay. And, um, at that point what was the discussion of which, uh,
716 (unintelligible) rounds you were gonna use?
717

- 718 A: Um, well we had the, uh, (unintelligible) penetrate. We had shotgun
719 (unintelligible) rounds as well as the 37-millimeter. Um, my concern was we
720 were too far away to get some good shots on there, but Brian Taylor thought
721 that we could, you know, we could make a shot. There's – there was talk
722 about going up here to the hillside behind some trees and doing it. Um, but I
723 got all the rounds that we had out of the trailer, and most of them were
724 barricading or penetrating barricade rounds, um some were (unintelligible)
725 than others.
- 726
- 727 Q: Okay.
- 728
- 729 A: But...
- 730
- 731 Q: Um, as far as, um, what is your understanding about the distance those are
732 effective at?
- 733
- 734 A: Well we went to – to school we, uh, had a window target and we went out to
735 50 yards and were able to – to successfully once we, you know, most, you
736 know, rounds in there accurately, so we were – we estimated it at 75. I
737 thought that might have been a little too far but, uh, the PD came up and did a
738 range finder of 65 so that changed my mind a little bit, but I thought it might
739 be better to shoot from here cause we had better coverage.
- 740
- 741 Q: Okay. And at that time, when you guys went back out, you guys you – you
742 didn't replace EPD's SWAT, they – you kind of – you came back in and they
743 assisted?
- 744
- 745 A: Yeah they left, uh, at first. But then when the decision to – to do the gas, they
746 came down the road and also helped a – a EP Officer Jones, I believe, about
747 the – the range and the success, you know, how – how successful you think it
748 would be to get them in there.
- 749
- 750 Q: Okay. Was there any EPD officers down in there with you guys at this time?
- 751
- 752 A: When we fired?
- 753
- 754 Q: Yeah.
- 755
- 756 A: No. Well they were up here by...
- 757
- 758 Q: The gas?
- 759
- 760 A: ...Brian Taylor's...
- 761
- 762 Q: Okay.

763
764 A: ...the -- there's two more patrol vehicles...
765
766 Q: Okay.
767
768 A: ...parked up here and that's...
769
770 Q: Okay.
771
772 A: ...where they were at.
773
774 Q: So, um, the plan is to shoot the 37-millimeter and on the four side A and B
775 windows?
776
777 A: Correct.
778
779 Q: Correct? Um, and you and Brian Taylor are the ones that are gonna do that.
780
781 A: Correct.
782
783 Q: Okay. Um, who goes first?
784
785 A: Brian Taylor.
786
787 Q: Okay. And the plan is a volley is five in each window?
788
789 A: Correct.
790
791 Q: Okay. Does he have to shoot more to get the (unintelligible).
792
793 A: Um, I think we shot probably at least 15 to 16 rounds to get about five into the
794 -- each window.
795
796 Q: Because of the distance?
797
798 A: The distance. Um, some were hitting low, um, they're, uh, made to go
799 through wood and so and some of the siding we weren't too sure is it going all
800 the way through or is it stuck in the wall. Um, there was a couple misfires on
801 some of the rounds where they just kind of petered out.
802
803 Q: Mm-hmm.
804
805 A: They hit the grass. So we just kept firing till we thought we had five in, uh,
806 each window.
807

808 Q: Okay. And, um, so once Brian Taylor does that do you go?
809
810 A: Yeah at one point he, uh, shoots a round and something flies back and nicks
811 him in the – in the nose and he starts bleeding all over the place, so I take the
812 gun and I can't remember how many rounds I fired but, you know, five, six,
813 or seven.
814
815 Q: Okay. How many volleys does Brian Taylor do?
816
817 A: Well for the whole mission, or?
818
819 Q: Just in the – in – in the beginning. Does he do the first volley, you do the
820 second?
821
822 A: He – he did the first and started the second and then I finished the second.
823
824 Q: Okay. And you did the same thing, tried to get five in each window?
825
826 A: Correct.
827
828 Q: And it probably took more than that?
829
830 A: Yeah. Just...
831
832 Q: Okay.
833
834 A: Well we also found some of the rounds we had, uh, penetrated better than
835 others so obviously we switched.
836
837 Q: Which w – which ones were those?
838
839 A: I can't remember the brand but there's a (Smooth Cone) – (Smooth Cone) one
840 that didn't seem to penetrate as well as the newer, just kind of (unintelligible)
841 I'd say clawed at the – I don't know if that's a right terminology, but it
842 penetrated better – I think it's a newer round (unintelligible) see...
843
844 Q: Okay.
845
846 A: ...(unintelligible) one.
847
848 Q: And was there ever a third volley that was done with the 37 millimeter?
849
850 A: I don't believe so. I think we went to the shock and then because we ran out
851 of most of the rounds that we had.
852

853 Q: Okay.
854
855 A: I think after I shot, yeah, after I shot we had to shoot the 37-millimeter...
856
857 Q: Okay.
858
859 A: ...cause then PD actually came and borrowed it.
860
861 Q: Okay. And then, um, with the shotgun did – did you deploy the shotgun
862 (unintelligible) rounds?
863
864 A: Yes.
865
866 Q: Did anybody else (unintelligible)?
867
868 A: Brian Taylor, we both.
869
870 Q: Okay.
871
872 A: And took turns.
873
874 Q: And was it one shotgun or two?
875
876 A: One shotgun.
877
878 Q: Okay. And, uh, those are just shot out of the shotgun...
879
880 A: (Unintelligible).
881
882 Q: ...a regular shell?
883
884 A: Yeah, it's Brian Taylor's duty issued.
885
886 Q: Okay.
887
888 A: It's 12-guage.
889
890 Q: And those are mainly the same as a 37-millimeter but quite...
891
892 A: Smaller.
893
894 Q: ...(unintelligible) they're smaller? Yes. Okay. And then who started with
895 those volleys?
896
897 A: Brian did.

898
899 Q: Okay. And was that again trying to get five into each A and B window?
900
901 A: I believe so. I don't know if the number five was mentioned cause I think we
902 talked that we might need a few more since they're smaller and they'd be less
903 - they'd be less gas dispersed so, I think cause we agreed that we'd shoot
904 more than the five, I'm not - I don't know if you came up with a number.
905
906 Q: Number. Okay. And so Brian went first then you would go, he would reload
907 type of thing?
908
909 A: Yeah. I think we - he went, then I went, and I think he shot again cause at
910 that point our intent was just to break up - try to break out the rest of the
911 window so we could port.
912
913 Q: Okay Define - define porting to me.
914
915 A: Well the porting (unintelligible) go up, CVC had a, uh, blanket. It was kind of
916 like your - the vests you wear and, uh, porting, going in to throw...
917
918 Q: So you wanted the window broken.
919
920 A: The window broken.
921
922 Q: You wanted the window broken.
923
924 A: Yes.
925
926 Q: Okay. So when you guys are down here and you've done all this is - and is
927 there any response from inside or anything?
928
929 A: Not that we can hear.
930
931 Q: While you guys are gassing the house is - is the negotiators talking?
932
933 A: Yeah after each round they - it is - you know, do a volley then they'd
934 negotiate for, you know, 15, 20 minutes.
935
936 Q: Okay.
937
938 A: No response and...
939
940 Q: Okay. And, um, who did - eventually someone makes a decision that you
941 guys are going to, uh, hand throw - toss gas into the residence?
942

943 A: Yes.
944
945 Q: Okay. Who makes that decision?
946
947 A: I hear it from Sergeant Quenell but I (unintelligible).
948
949 Q: Okay. And how are you guys doing about doing that?
950
951 A: Well the CVC had the – the resisted blanket on a pole, um, two people held
952 that and walked up to the window undercover.
953
954 Q: Who – who's we?
955
956 A: Um, (Massaro), Brian Taylor, (Jessie Taylor), Brian Quenell and myself.
957
958 Q: So the same guys that...
959
960 A: We were all over here.
961
962 Q: ...were here. CVC came down and...
963
964 A: Took our spots as far as covering.
965
966 Q: Okay. And, um, who was supposed to introduce what?
967
968 A: The – I was going to deploy both – both grenades into A and B.
969
970 Q: Okay. Say both grenades, what do you mean by grenades?
971
972 A: Well it's a gas, uh, grenade for lack of better name for it, um... it – it's similar
973 to the 37 millimeter except for it's – it's hand deployed and...
974
975 Q: (Unintelligible).
976
977 A: ...(unintelligible).
978
979 Q: ...in the pole.
980
981 A: Uh...
982
983 Q: You do...
984
985 A: Top flies off.
986
987 Q: You toss it into a window ad it just sprays out?

988
989 A: Sprays out.
990
991 Q: Is it like an aerosol type of thing or?
992
993 A: The ones we have were.
994
995 Q: Okay.
996
997 A: Where they were smokeless, burnless, and uh, and it's CN.
998
999 Q: Okay. It's CN?
1000
1001 A: CN?
1002
1003 Q: Okay. And so you guys come up and do that. You have...
1004
1005 A: Or CS...
1006
1007 Q: CS.
1008
1009 A: ...actually.
1010
1011 Q: You have both of them. Okay.
1012
1013 A: Mm-hmm.
1014
1015 Q: And which window do you throw into first?
1016
1017 A: The A window.
1018
1019 Q: The A window.
1020
1021 A: Walk up to A, throw it in, scoot over to B, throw it in.
1022
1023 Q: And then you guys returned?
1024
1025 A: Right.
1026
1027 Q: Same thing going on, negotiations attempted?
1028
1029 A: CVC still...
1030
1031 Q: Still nothing going on in the house?
1032

1033 A: Don't hear anything. No we are on the radio that we, you know, they see him
1034 in the back rear of the house, but...
1035
1036 Q: You heard that and – that he's back in the rear of the house?
1037
1038 A: Yeah. I never heard or saw him...
1039
1040 Q: Okay.
1041
1042 A: ...the whole incident.
1043
1044 Q: And, um, what's next to happen?
1045
1046 A: Well we – we negotiate some more, um, the CVC guys are down there and
1047 they're suggesting that we use a, um, a smoke, you know it's a agent with
1048 smoke cause they'll carry better throughout the house rather than just aerosol.
1049 Then we agree with that, they bring down the, uh, a vest that's loaded down
1050 with all kinds of, um, different types of CS, uh, grenades. Um, they point
1051 them all out. They – they show me the - (unintelligible) be is the triple
1052 chamber, which I also used at school and said, you know this is non-pyro, it's
1053 fairly safe.
1054
1055 Q: You – you said this?
1056
1057 A: They – they were telling us.
1058
1059 Q: Okay.
1060
1061 A: Um, so they give me the vest and we put it on. Or I had put it on over my –
1062 my, um, vest and it – at some point in the discussions decided that I don't
1063 need to where this – the whole vest - (unintelligible) just carry (unintelligible)
1064 on there. Um, well I don't have it on at one point. I asked him make sure you
1065 take out the – the pyro, then you point out a couple of grenades said these will
1066 definitely light the house on fire. So we'll just take those out of the vest right
1067 now cause we're not talking about that at this point. So they take them out,
1068 put them aside, and then I decided later that wearing the vest isn't practical so
1069 I take that off, and one of the CCI's (unintelligible) decided to throw the sting
1070 ball in at the same time for of us. It has, uh, more of a psychological effect.
1071 Um, so he – he loads that on...
1072
1073 Q: Onto your vest then?
1074
1075 A: Yeah.
1076
1077 Q: Okay.

1078
1079 A: I – I – take their vest off with all of this stuff and he was giving me two – two
1080 of the triple chambers and the steam ball, and the sting ball I load on the – my
1081 holster and the other two are put in the pouches.
1082
1083 Q: Okay. And once again the same guys walk up?
1084
1085 A: Same guys walked up.
1086
1087 Q: He – Jamie how are you – are you trying to hide under the blanket when
1088 you're throwing these things in, how is that going on?
1089
1090 A: Well I got to peek up and (unintelligible) clear look. As we're going up there
1091 I'm providing cover for the guy that's carrying the blanket.
1092
1093 Q: Okay.
1094
1095 A: Then we get close enough and throw the rifle down, get some (unintelligible)
1096 get it ready. We stop at the window. And you can see, I mean they're holding
1097 it at their shoulder, so...
1098
1099 Q: So they're holding it like in front of you type of thing then?
1100
1101 A: Mm-hmm.
1102
1103 Q: Okay. And it's like a wall type of thing?
1104
1105 A: On everyone else.
1106
1107 Q: The two guys do that and you're...
1108
1109 A: Yeah we're carrying – I'm in the middle, Brian's in the middle, and I'm not
1110 sure where (Jessie) was, he was somewhere.
1111
1112 Q: Okay. (Unintelligible). So you, um, you go up there and which window did
1113 you go to first?
1114
1115 A: The – we went to the same one, A.
1116
1117 Q: So every time you threw something you went to A first?
1118
1119 A: A first.
1120
1121 Q: What were you supposed to put into the A window?
1122

1123 A: The triple chamber, uh, CS gas.
1124
1125 Q: Okay. And that's pin and...
1126
1127 A: (Unintelligible) the pin, throw it...
1128
1129 Q: Throw it in there.
1130
1131 A: And it – it pops.
1132
1133 Q: Okay. And when you threw it up there did it go in?
1134
1135 A: Yes.
1136
1137 Q: Okay. And then you went over to – over to the – did – did you notice it
1138 smoking right away?
1139
1140 A: No, I didn't – I mean we – I – it didn't move and didn't see...
1141
1142 Q: Okay.
1143
1144 A: ...it smoke right away.
1145
1146 Q: And then you went to the B window.
1147
1148 A: Correct.
1149
1150 Q: What happened then?
1151
1152 A: Threw the sting ball first and I heard – I heard that go. I mean it – I – we were
1153 talking about it before to give it a – as hard a blow as you can to get it further
1154 back in the house to produce more effect. So I gave it a good toss. It went in,
1155 took the triple chamber, gave it a good toss and (unintelligible) sneak
1156 (unintelligible) vinyl window and popped back out of this...
1157
1158 Q: So the – the middle things...the two windows on the side are broken out, the
1159 middle?
1160
1161 A: Yeah, the metal piece...
1162
1163 Q: Okay.
1164
1165 A: ...vinyl of the window.
1166
1167 Q: Okay. And what happened to – to that round?

1168
1169 A: Well it's -- bounces out and lands over here somewhere.
1170
1171 Q: Okay.
1172
1173 A: I, you know, I thought ooh, crap, that's no good. We started going back and I
1174 hear Brian, I see him go around the blanket, so we stopped, seen him pick it
1175 up, and he tosses it into window B.
1176
1177 Q: Okay.
1178
1179 A: And then we all go back to...
1180
1181 Q: Okay.
1182
1183 A: ...the vehicles.
1184
1185 Q: And when you guys return there obviously then the -- they're still trying to
1186 give surrender orders and stuff like that.
1187
1188 A: Still negotiating.
1189
1190 Q: And, um, anything going on in the house?
1191
1192 A: No, it's smoking up I guess.
1193
1194 Q: Okay.
1195
1196 A: Mm-hmm.
1197
1198 Q1: Does that smoke that comes out of those have a certain type of the, uh, I guess
1199 a certain type of color?
1200
1201 A: Well it -- it's a lighter, um, it's a light gray color I guess you can call it. Yeah
1202 it looks like the smoke itself it's not as thick.
1203
1204 Q1: Okay.
1205
1206 A: Like a -- a fire smoke.
1207
1208 Q: Okay. And then, um, all that continues. What is the next thing that you guys,
1209 uh, noticed, uh, going on with the house?
1210
1211 A: Well we were -- all of us are at the rear of the vehicles. CVC is still watching
1212 the house, um, we're kind of resting from the -- the two deployments we have.

1213 Um, you know, I turned around every once in a while look at it, you can still
1214 see in the – the gas is going off for a good four or five minutes, probably even
1215 longer than that. Um, I remember looking at one point oh my goodness it's all
1216 gone. Um, I heard one of the CVC guys say there's more – more smoke
1217 coming out of the A window.
1218

1219 Q: Mm-hmm.
1220

1221 A: I turned to look and, um, yeah there's – there's some more smoke developing.
1222 It does look different, and it – it's not from the – the CS gas cause that's been
1223 long deployed. Um, and it appears to be, um, smoke from the fire.
1224

1225 Q: Okay. Kind of like a darker smoke then?
1226

1227 A: Yeah, a darker gray smoke.
1228

1229 Q: Okay. And how much – how much time had passed the – that you – it – there
1230 wasn't anymore smoke in there then all of a sudden there's...
1231

1232 A: Different.
1233

1234 Q: ...different colored smoke?
1235

1236 A: I'm gonna estimate two to three minutes, if not longer.
1237

1238 Q: Okay.
1239

1240 A: But I wasn't paying too close attention to the – at that point.
1241

1242 Q: And, uh, is there any mention, I mean obviously did – does anyone say there's
1243 a fire inside at that time?
1244

1245 A: Said there – there's a couple people mention that it appears to be...
1246

1247 Q: Okay.
1248

1249 A: ...a fire and I'm – I believe at that time (unintelligible) got on, cause I mean it
1250 started billowing pretty quick and negotiations started I remember everybody
1251 saying, you know, it looks – "looks like a fire in there, you should come out
1252 now – should come out now."
1253

1254 Q: Okay. And still nothing from the house?
1255

1256 A: Nothing.
1257

1258 Q: Okay. Um, and eventually do you see flames coming from the house?
1259
1260 A: After a while. It took a while for flames, I think – cause it had billowed up for
1261 a while and then it looked like it might a smoldered out and the smoke
1262 lessened, but then it – it'd start again.
1263
1264 Q: Mm-hmm.
1265
1266 A: Would become thicker and eventually just got real thick and at first glance I
1267 saw over – over on – over on the...
1268
1269 Q: Over on the...
1270
1271 A: ...(unintelligible) side.
1272
1273 Q: ...your side?
1274
1275 A: Mm-hmm.
1276
1277 Q: Okay.
1278
1279 A: That's a good probably 10 minutes after the smoke started.
1280
1281 Q: And it – it eventually it – it becomes fully engulfed.
1282
1283 A: Fully engulfed. Mm-hmm.
1284
1285 Q: Okay. And, um, after that you guys clear from there and do the – the normal
1286 things that we do in – in an investigation like that.
1287
1288 A: Yeah. Well I mean it becomes – it's fully engulfed, um, you know, you got
1289 the fire trucks coming down the road but obviously all these cars are – are
1290 blocking it so you get those maneuvered out of the way and I kind of went up
1291 here in the grass and watched them put out the fire at that point.
1292
1293 Q: Okay.
1294
1295 Q1: Was there still a worry about him coming out?
1296
1297 A: Personally it was fully engulfed I wasn't worried about that, but there was,
1298 um, you know you...
1299
1300 Q1: Not – not so much at that – at that point, but I'm – I'm talking about until the
1301 – prior to the...
1302

1303 A: Oh definitely...
1304
1305 Q1: ...fully engulf.
1306
1307 A: ...cause he was, uh, I mean it pretty much burnt from four side back to two
1308 sides.
1309
1310 Q1: Yeah.
1311
1312 A: It – it became, uh, fully – I mean this is pretty much destroyed, but we still
1313 heard, uh, you know people on the radio saying they saw him in the rear.
1314
1315 Q: Did you hear it when – when it was on fire did you hear any noises?
1316
1317 A: Yeah there's all kinds of popping, crackling, uh, - there was at one point, um,
1318 the CVC guys were still had eyes on and a couple of times they said, "There's
1319 movement from in the room at the window." Um, and then they say, "Well
1320 no, that must have been smoke reflection," or, you know, it wasn't. And we –
1321 we believe we heard a muffled what sounded like a gunshot. We thought
1322 maybe he took his own life there but...
1323
1324 Q: Well you believe it might have been all the rounds that were in the house
1325 cause...
1326
1327 A: Yeah. There's – there's definitely more, um, popping noises all the way to the
1328 end of the – even when the fire department's pulling up you still hear em...
1329
1330 Q: Okay.
1331
1332 A: ...popping off.
1333
1334 Q: Okay. Um – and can you explain these (ferret) rounds a little – the – the at
1335 least (unintelligible) the 37 millimeter first when – when those go in, uh, how
1336 do they work?
1337
1338 A: Well it – it comes with enough force to – to penetrate, um, a (unintelligible)
1339 solid core door at school and, you know, I think it's 25 to 30 yards and they
1340 would hit, go through, and then when they hit a – an object – it's supposed to
1341 disperse the – the CN CS gas it has in there.
1342
1343 Q: Okay.
1344
1345 A: But it's designed to penetrate whatever, I mean it should go through the glass
1346 through...
1347

- 1348 Q: And it's only a liquid or powder that's inside of those?
1349
- 1350 A: Correct.
1351
- 1352 Q: Okay.
1353
- 1354 A: I believe the – the shotgun ones were powder but not...
1355
- 1356 Q: Mm-hmm.
1357
- 1358 A: ...(unintelligible).
1359
- 1360 Q: Something that's saying it's nothing that has a flame or anything?
1361
- 1362 A: Oh no, those are – I think def – there's no flame involved in that at all. So...
1363
- 1364 Q: And I don't – I don't really know anything about those sting balls or whatever
1365 they call them. How – how do those work?
1366
- 1367 A: The – the sting ball we had, um, I'm not sure of the gauge (unintelligible) but
1368 there is, um, some have up to 60, some have 30, they're – it's the same, it's
1369 like a grenade. They throw it in, the spoon goes off and it discharges however
1370 many rubber balls are in it, at 360 degree area along with some CS or CN
1371 depending on the type of gas you have in it.
1372
- 1373 Q: Do you ever have ball – I mean is it like – is it like a flash bang type of thing?
1374 It can explode like that type of thing and then shoots them out?
1375
- 1376 A: Yeah.
1377
- 1378 Q: Okay.
1379
- 1380 A: Shoots it, but, uh, again, that – there's no flames involved with that, it just – it
1381 comes apart. I'm not sure on the technical aspects on what makes it come
1382 apart.
1383
- 1384 Q: Is it kind of like pressure?
1385
- 1386 A: Yeah. There's – there's some sort of a firing pin. It, you know, it – when the
1387 spoon gets a firing pin hits a – I don't know if it's rifle powder or what it is to
1388 make it go but it – it goes off and...
1389
- 1390 Q: Okay. And you – you – you said you had – you – you ever had anything to do
1391 with this triple chamber thing except for at training?
1392

- 1393 A: At training.
1394
1395 Q: And when – and there – was this school training?
1396
1397 A: Mm-hmm
1398
1399 Q: But explain – explain the CS smoke to me a little.
1400
1401 A: The smoke or the?
1402
1403 Q: Well let's start with the smoke, how it – I mean is it, the s – the smoke comes
1404 out and the CS is in the smoke for a certain reason, is that right?
1405
1406 A: Well the smoke helps it, uh, it carries the agent further and penetrates more a
1407 – of an area than just aerosol that we were using. The – on the first one we
1408 deployed is just aerosol.
1409
1410 Q: Okay.
1411
1412 A: So you can see, I mean you heard it pop and you didn't see - if you're in there
1413 you'd definitely feel it.
1414
1415 Q: Okay. And – and how – how does the triple chamber work?
1416
1417 A: Well there's three different chambers on there. Um, again the technical issues
1418 I'm not sure on how it keeps it from flaming up, but it's definitely – it – it has
1419 to be heated for the – the smoke to – to go, but when we were in school they
1420 used – they got a paper can with a bunch of shredded newspapers in there and
1421 threw a triple chamber in there. It went off, all the smoke went off and you
1422 looked at it later and, you know, no fire, maybe just a tad bit of char on the
1423 paper cause, uh, the gas itself heats up...
1424
1425 Q: Mm-hmm.
1426
1427 A: ...to release the smoke and that might have charred from the paper but...
1428
1429 Q: And could you pick up one of those canisters with your bare hand?
1430
1431 A: You – you can because Brian did, but they – the – the longer it burns the – it –
1432 it heats up.
1433
1434 Q: Okay.
1435

1436 A: So if it – if it's been burned for a while you – you probably, I don't think
1437 you'd get second-degree burns but when – you can probably do it and throw it
1438 fast.
1439
1440 Q: And just – what – do we have any of those ourselves, the (unintelligible)?
1441
1442 A: I don't believe so.
1443
1444 Q: Okay.
1445
1446 A: I don't believe so.
1447
1448 Q: And it – so what items that we used to introduce into the residence belonged
1449 to CVC?
1450
1451 A: The only ones that belonged to CVC were on the second mission was the sting
1452 ball and the two triple chambers.
1453
1454 Q: Okay.
1455
1456 A: Everything up to that point was stuff that...
1457
1458 Q: So the first two...
1459
1460 A: ...they got (unintelligible).
1461
1462 Q: The first two you threw – threw in the aerosol I guess we can say is what
1463 those are?
1464
1465 A: Yeah, from...
1466
1467 Q: Okay.
1468
1469 A: ...those are ours.
1470
1471 Q: And it – the second one was the two smoke ones and...
1472
1473 A: Sting bomb were -- were all provided by...
1474
1475 Q: Okay.
1476
1477 A: ...CVC guys.
1478
1479 Q: Um, and you – you said something that pyrotechnics were mentioned by C –
1480 CVC at one point, and...

1481
1482 A: Yeah, well he pointed out two – two grenades on the vest and said, “These
1483 will definitely start a fire for sure if deployed.”
1484
1485 Q: Okay.
1486
1487 A: I said, “Well I’m pretty sure we’re not gonna – we’re not doing that,” so let’s
1488 just take them off the vest and leave them here, so there’s no accident, and
1489 then I ended up not even wearing the vest, so...
1490
1491 Q: Okay. Okay. As far as us having any pyrotechnics did we have any of those?
1492
1493 A: I don’t know. I didn’t see any were in the trailer.
1494
1495 Q: Okay.
1496
1497 A: Our burns and I mean smokeless. I mean there’s some smoke grenades in
1498 there but they were still there. I never took them out.
1499
1500 Q: Okay. Jamie when you were there did it – I’ve been hearing mention of –
1501 there – the – that the fireplace or something like that, did you ever hear
1502 anything about that?
1503
1504 A: Yeah I heard it on the – on the radio (unintelligible), uh, (unintelligible)
1505 watching and during the night. Uh, there’s always light coming out of the –
1506 the B window.
1507
1508 Q: Mm-hmm.
1509
1510 A: And it appeared like there was a TV on or something flickering. Looked like
1511 a TV to me. Um, a couple points I mean A was a – pretty much dark
1512 (unintelligible) G’s, and there was at one point where there is a – there’s a
1513 odd-looking kind of light, cause it was real flashy, which we deducted was
1514 either a fire – we thought maybe he was, um, you know, there was mention
1515 maybe he’s smoking – smoking a bowl, because you – you light it and you
1516 can k – kind of look like...
1517
1518 Q: Mm-hmm.
1519
1520 A: ...the flames and then I heard other people talking about that he actually built
1521 a fire in which we didn’t see.
1522
1523 Q: Okay.
1524
1525 A: And...

1526
1527 Q: Did you ever – in – did you ever see smoke coming out of the chimney or
1528 anything like that?
1529
1530 A: No.
1531
1532 Q: Okay. As far as ample opportunities for a – a – pretty much once you guys
1533 were fired on it's in a surrender mode, he needed to surrender (unintelligible)
1534 right?
1535
1536 A: That's the way I understood yes.
1537
1538 Q: Um, in – in your own opinion do you think he was given ample opportunity
1539 to...
1540
1541 A: He was given more than enough.
1542
1543 Q: Okay. And also when there – when you – you seen there was the flames start,
1544 was there, um, you know, the – everything continued when – and there was no
1545 response and he just...
1546
1547 A: No.
1548
1549 Q: ...uh, ignored what you guys were telling him?
1550
1551 A: (Unintelligible) on the – on the – the horn, this – when the smoke started it
1552 was pretty much non stop for the next, you know, half hour, however long it
1553 took to be fully (unintelligible)...
1554
1555 Q: Mm-hmm.
1556
1557 A: ...engulf and, uh, he was non stop now, "it looks like there's fire, you need to
1558 come out now." You know, there's a constant repeat of, "This isn't no big
1559 deal. We'll work it out. You can come out," etcetera, etcetera.
1560
1561 Q: Jamie (unintelligible) just recently went to this training, what did they tell you
1562 in regards to, um, ways people can protect themselves from CS gas or any
1563 type of gas?
1564
1565 A: Well there's – I mean if you cover your nose and mouth with any kind of wet
1566 cloth or anything you can – I understand that CS is pretty, I mean just going
1567 through the smoke myself without any protection it doesn't just get into your
1568 lungs. It stings kind of like a (unintelligible) all over the place, so...
1569
1570 Q: And – and – why do you think the gas was, uh, not that effective?

1571
1572 A: I think it was – it was only effective in the pushing him back to the back,
1573 cause you can close doors, stuff towels, try to keep the gas from – it's not
1574 gonna go through solid – solid walls and it'll only creep under the door...
1575
1576 Q: Mm-hmm.
1577
1578 A: ...too much, and especially the aerosol that we used initially doesn't carry as
1579 much, like it would with smoke, so...
1580
1581 Q: Can water dissipate?
1582
1583 A: If you wash the agent off.
1584
1585 Q: Okay. And going back to the – to when – when you guys were down here
1586 Jamie at the – the travel vehicles, when you – when you saw the silhouette up
1587 there and something else and the shots rang out, what – what was the first
1588 thing you were thinking about?
1589
1590 A: Well when – I heard the shots and heard what sounded like impact the first
1591 thing you think of, I can't believe he just did that. And the second thing is,
1592 you know, protect yourself, stop him from going any further, and..
1593
1594 Q: And, um, on your – with your rifle you received training with your rifle?
1595
1596 A: Oh yeah.
1597
1598 Q: And you guys qualify don't you?
1599
1600 A: We qualify.
1601
1602 Q: And then with the SWAT Team you guys also...
1603
1604 A: We qualify with a requirement on our – I think every six months and then,
1605 um, (unintelligible) SWAT Team in March I – when we fired on the initial,
1606 uh, to get into SWAT yeah the – to fire – or no we fired handgun to get in.
1607 But since I've been on there we've had one – at least one range.
1608
1609 Q: Okay.
1610
1611 A: And...
1612
1613 Q: And your – your qualifications and your training with the SET Team it – that
1614 is documented?
1615

1616 A: I believe so, yeah.
1617
1618 Q1: Uh, just a couple things for you. On – you still have a AR 15?
1619
1620 A: Correct.
1621
1622 Q1: Do you have a 40-millimeter long (unintelligible), is that capable of, uh,
1623 deploying gas?
1624
1625 A: Yes.
1626
1627 Q1: Do you have those rounds available to you, and what was the purpose for not
1628 using the 40-millimeter?
1629
1630 A: Well one, um, I just got – I – I went to school and when I went to school I
1631 took a full-sized AR 15 with me that had the gas, um, launch on it and so
1632 that's what I shot at school, and it didn't have the – the sites like I do on, uh,
1633 my set rifle now. So I shot that at school, then came back and, uh, the armor,
1634 put the launch on the – the short barrel with the classical stock and I be – I
1635 haven't yet fired that on the range yet. So there's two (unintelligible) I don't –
1636 didn't use. I didn't feel comfortable with it since I haven't practiced with it
1637 yet. And, um, at school they, uh, they said the 40-millimeter isn't as accurate
1638 or, uh, as far reaching as the 37-millimeter, cause there's a lot of gas at this
1639 space. It's not as tightly built in the rear so accuracy was a concern from
1640 where we were at, then besides the fact that I haven't shot it yet on the – on
1641 the (unintelligible).
1642
1643 Q1: Okay.
1644
1645 A: (Unintelligible).
1646
1647 Q1: Um, you talked about flickers and maybe a flashlight, what – tell me about the
1648 flashlight. Did you ever see him holding it or a – a figure holding it, or...
1649
1650 A: Well the flickers were – you – you could tell that in between the artificial light
1651 and the kind of a – what I described as – as flickering, because it – it just – it
1652 was in short bursts and kind of – it's hard to describe, I mean (unintelligible) a
1653 flashlight at the bottom of the window you can definitely see a round light,
1654 you know, pointing at you through the MBG's.
1655
1656 Q1: Mm-hmm.
1657
1658 A: It seemed pretty apparent that...
1659
1660 Q1: Moving.

1661
1662 A: ...it's – it's moving, it came on, it came off, where as a flicker is kind of
1663 sporadic.
1664
1665 Q1: Mm-hmm.
1666
1667 A: And it – it's – still not sure exactly what it was.
1668
1669 Q1: Um, we talked about the deployments with the – the hand held gas, uh, to
1670 number four side windows, A and B. Then there's also a mention of a sting
1671 ball, um, why did you use a sting ball? What's its purpose?
1672
1673 A: Uh, the sting ball is, uh, kind of like a flash bang it – distraction, um,
1674 psychological, um, it – it's not – I mean it – it's painful to get hit by the ball
1675 but it's not – it – it – it's like a sting and it's intended to, um, I mean, you
1676 know, shock him, or, you know that's – that's the way I could best describe it.
1677 It's more of a psychological.
1678
1679 Q1: So is that a safety issue to use those while you're rather close to the – to that
1680 area?
1681
1682 A: Yeah it – it helps to – to use that – I mean if he's in the room before we throw
1683 he's definitely gonna be going the other way when it goes off. So when we
1684 throw the gas it's – it – it's more of an insurance.
1685
1686 Q1: How close did you guys get to the window?
1687
1688 A: Two or three feet. That, uh, I mean we came right – right on it there above
1689 our heads just a bit. We didn't get up to touch the wall but a couple feet back
1690 from the wall.
1691
1692 Q1: Okay. Also at that same point there at the second deployment you mentioned
1693 where you had thrown a hand-held and it didn't make the target and fell on the
1694 ground, and in the (unintelligible) the sergeant picked it up?
1695
1696 A: Right.
1697
1698 Q1: How's the – had that deployed was there gas coming out of it at that point?
1699
1700 A: Mm-hmm.
1701
1702 Q1: There was?
1703
1704 A: There was some s – yeah, there was some smoke coming out and...
1705

1706 Q1: Now was he wearing gloves?
1707
1708 A: No.
1709
1710 Q1: So barehanded he was able to pick that up?
1711
1712 A: Right.
1713
1714 Q1: Threw it back into the target window. Okay. I don't have anything further.
1715
1716 Q: Were you – were you guys masked up and all that?
1717
1718 A: Yes. Yes.
1719
1720 Q: Okay. Um, with your experience in – in that, um, as far as the fire part, do –
1721 do you think the smoke could cause that – the – the smoke canister?
1722
1723 A: There – there's a – a remote chance that – I mean cause the canisters do heat
1724 up. I mean none of these things are guaranteed...
1725
1726 Q: Mm-hmm.
1727
1728 A: ...you know. But just watching the – the demonstration in school and – I
1729 mean, you know, with this shredded paper and all it did was charred a little bit
1730 of it, it seems unlikely that it – it would – could start a fire.
1731
1732 Q: If there was an accelerant spilled or something do you think?
1733
1734 A: I don't think it heats up enough to – to start an accelerant. Now if it – if it – if
1735 it caught something, you know – you know, if there's a bunch of dried
1736 sawdust or something around there and it accidentally caught a spark, which
1737 caught the accelerator, etcetera (unintelligible) so there – I'd say it's possible.
1738 I'd say it's unlikely.
1739
1740 Q: Okay. So but that, from the experim – experiment – not the experiment but
1741 that's the best word I got, with the – the paper in there it just charred the
1742 paper.
1743
1744 A: Very slightly.
1745
1746 Q: Not enough.
1747
1748 A: Not enough to – to cause a spark or a flame (unintelligible).
1749

1750 Q: Okay. Jamie, is there anything else that we haven't asked you that you think
1751 would be port most – important for us to know about with the incident?
1752

1753 A: Mm, I don't think, uh, I don't know if I mentioned that when the CVC guys
1754 were watching, cause they had eyes on the smoke the whole time, um, they –
1755 they – they said the – that the gas went away, a couple minutes went by and
1756 then smoke started. Now I don't think they saw anyone in the window but
1757 they were under the impression that he would have started the fire, and not the
1758 canisters.
1759

1760 Q: Okay.

1761 A: That's what their observations were.

1762 Q: Okay. And Jamie can you sign this, it's a little sketch we did for a – for me.
1763 Paul you got anything?
1764

1765 Q2: No questions. Thank you.
1766

1767 Q: Okay. All right. Thank you. We'll end the interview at 1132 hours.
1768

1769
1770
1771
1772 This transcript has been reviewed with the audio recording submitted and it is an accurate
1773 transcription.
1774

Signed _____

HUMBOLDT COUNTY SHERIFF'S DEPARTMENT

CASE: 200703162
INTERVIEWER: Rich Schlesiger, Detective
SUBJECT: Attempt PC 187/ Officer Involved Shooting
STATEMENT OF: Edward Kenneth Guyer II, Tribal Police
DATE & TIME: June 3, 2007 @ 2106 hours.
LOCATION: Hoopa, California

ALSO PRESENT:

RS Rich Schlesiger
EG Edward Guyer

RS Okay date is June third (3rd) two thousand seven (2007), time is twenty one oh six (2106) hours, we're in my, Ed do you know is it Bald Hill and not Bald Hills?

EG This is Bald Hill Road and Bloody Camp also.

RS Okay. What's your middle initial?

EG Kenneth. "K", the second (2nd).

RS What's twenty five (25)?

EG Zero three (03).

RS Zero three 903). Okay um obviously there's an investigation going on pertaining to [REDACTED] who is barricaded in a residence and shooting that the officers that are on scene, from what I understand I talked to you briefly about an hour ago and you said you were one (1) of the people that received uh shots from him?

EG Yes.

RS Have you ever had dealings with [REDACTED] before?

EG Yes I have.

RS Um what kinds were those?

EG Um just last week [REDACTED].

RS Where was that at?

EG That was in Campbell Field in Hoopa.

RS At his mom's house?

EG At his mothers house.

RS Why [REDACTED]

EG He was making statements that he can't be hurt, nobody can hurt him, people are trying to kill him, point lasers at his head but he can't be killed. He can do anything, he's indestructible he can drink gasoline.

RS Okay.

EG And his name was [REDACTED].

RS Okay. Um and so you took him as a danger to himself and others?

EG Correct.

RS Okay. Um did he fight with you guys anything like that?

EG He was aggressive, he had a knife in his pocket, a butter knife which was sharpened, um he was aggressive but at the time he didn't fight. We placed him in the back of the patrol vehicle and he started kicking the windows or hitting the windows with his head.

RS Do you remember what day that was on?

EG I believe it was on the twenty fifth (25th) of May, or twenty sixth (26th) I'm sorry cause it was after midnight.

RS Okay. Um any other dealings besides that one(1)?

EG Um earlier in the week, I also, he's been at the casino, he's an unwanted [REDACTED] from the casino and we've um cited him out for trespass. He wasn't allowed there and we cited him out for trespass.

RS Okay. And you work for the Tribal police Department here in Hoopa?

EG Correct.

RS What time did you start your shift today?

EG I was called out around three twenty (3:20).

RS Were you called out because of this?

EG Yes I was.

RS Okay what were you told?

EG I was told [REDACTED] [REDACTED] locked himself into [REDACTED] house with a gun.

RS Okay.

EG And he was waiving it at the officers.

RS Okay. Have you ever been to this residence before regarding [REDACTED]

EG No.

RS Okay. Um so you got ready, went and got your vehicle, came up here?

EG I responded from my house, I have a vehicle at home.

RS Okay. Did you pick anyone up or was it just yourself?

EG Just myself.

RS Okay. Do you know what time you got here about?

EG Um right around three thirty eight (338) I believe, roughly.

RS Okay.

EG I think I looked at the clock as I was pulling in.

RS Okay was there anybody else on scene?

EG Um we were advised that Deputy Berry and Officer Landreneaux from Yurok's were here but they were on the other side of the residence.

RS Okay.

EG Right in front of me was Chief Hostler.

RS And you were advised what that he was barricaded and?

EG He was waiving a gun at the officers.

RS Okay, okay. So you arrived in a marked patrol unit?

EG Correct.

RS Okay and you're dressed the way your dressed now?

EG Correct in my uniform.

RS Okay and um what do you do when you arrive?

EG We arrive, we park down below the residence because of the fact that he's armed, we see him come to the window on the south side, south east side of the residence and look out the window at us, I don't see a weapon but,

RS Okay did you recognize that as [REDACTED]

EG Yes I did.

RS Okay. Um were any commands being yelled or anything like that?

EG He looked out the window and at that time, no he ran back inside the residence.

RS Okay. Who else was on scene when you arrived?

EG Uh Chief Hostler was the only other person.

RS Okay anybody else?

EG Um well I'm assuming Officer Landreneaux and Deputy,

RS And Landreneaux we're talking about

EG Heather Landreneaux.

RS Heather okay and Deputy Berry were on scene.

EG And Deputy Berry.

RS Okay. Okay and you parked your vehicle, I kind of got to look at the house a little, you would have been south of the house, I'm, how does the driveway go down in there?

EG The, the driveway loops around in front of the residence along the side, we were parked south, a little bit south east, maybe east, south east of the residence, it was just, we weren't directly south of it but we were off to the side a little bit.

RS Okay how did you park your, your patrol unit?

EG We parked, I parked my patrol vehicle next to hillside.

RS Okay.

EG And opened my door as for protection from the residence.

RS Okay. So was there a little bank there?

EG There's a bank there.

RS And that would have been on the, the

EG Passenger side of the vehicle.

RS The passenger side which is the north side of the gravel road?

EG Correct.

RS Okay and how did you take up your stance?

EG My stance was just standing in the doorway, on the drives side door way with um my shotgun, covering the residence.

RS Okay. Was there anybody else there?

EG Chief Hostler was in front of me in his vehicle.

RS Okay. So you were behind Willie and where, where was Willie standing?

EG Willie was also standing in his drivers door side.

RS Okay was there anybody else around you two (2) at that time?

EG Not at that time.

RS Okay then what happened then?

EG Um we stood on, we were on scene waiting for other additional units to arrive, um C.H.P. Officer Mike Nolan arrived and came up to assist me. Um Sergeant Kevin Miller arrived and was talking to Chief Hostler and Officer Matt Spallino from Hoopa arrived, as we were covering the house we had no movement on this side but we heard reports from Greg Berry's side that he had come on the porch waiving a gun around.

RS Okay and where did Nolan and Miller park?

EG They parked behind my vehicle on the dirt road.

RS Okay, so Willie, you,

EG I believe it's Kevin, Sergeant Millers car.

RS Okay.

EG Or I'm sorry Mike Nolan's car, Kevin Millers car,

RS Okay.

EG And then Matt Spallino.

RS Okay.

EG And then Deputy Brian Taylor arrived on scene.

RS Okay. So he could look out the window and, and see that you guys were cops?

EG Correct

RS Okay.

EG When I first arrived our lights were on, our overhead lights were on.

RS Okay. What happen after that?

EG After the, after we arrived there or after the deputies or the other deputies arrived?

RS Who arrived next?

EG Um Deputy Brian Taylor.

RS In his patrol unit?

EG Correct.

RS Where did he park?

EG He parked behind the other vehicles that were in the line.

RS Okay. So it's kind the, I'm guessing it's a pretty narrow driveway like the.

EG It's a one (1) lane road down to the residence.

RS And he parks there, okay and then uh what happens after that?

EG Um Sergeant Miller talks to Deputy Taylor and advises him, since he's on the SET team to cover the front vehicle with Officer Spallino. Officer Mike Nolan and I cover the, were with the second vehicle covering that house.

RS Okay.

EG So Deputy Taylor and Officer Spallino are in the front vehicle, Deputy Taylor's on the drivers side and Officer Spallino is on passenger side with the door open, with there firearms aimed towards the house, and in my vehicle which is the second vehicle, Officer Mike Nolan from CHP was on the drivers side, I was on the passengers side, with both of our weapons pointed towards the residence.

RS Nolan was on the driver's side?

EG Correct.

RS Okay and is anything going on with the house or [REDACTED] inside?

EG At this for about five (5) minutes, there's nothing going on. He comes to the, [REDACTED] comes to the window and says "you guys better back off, I got, I got my M sixteen (M16) and I'm going to take you all out".

RS Okay. Describe the, the house to me a little.

EG All we can see of the house, is the south is the south side of it, which would be the, there's two (2) windows, there's one window it's a single wide trailer with an addition build on.

RS Okay.

EG And there's a window on the addition side, which would be the left side, which would be the west side and then the trailer side is the, on the east side and there's window's glass window's that slide um (inaudible) back and forth not.

RS Okay.

EG Not up and down.

RS Okay. And so which window do you exactly see him out of then?

EG He went to left window on the west side.

RS Okay.

EG And yelled out "you guys better back off I got my M sixteen (M16) and I'm gonna take you out".

RS Okay what happens after that?

EG He goes back inside the residence for a minute and we were watching the window he was at.

RS He just goes away from the window?

EG He goes one (1) side, away from the window.

RS Okay. Where's the front door to the residence from that window?

EG It's directly across from that window.

RS Okay.

EG Which, it's a single room which is directly across from the front door.

RS So you could see the front door?

EG No we can't see the front door from our angle.

RS Oh so the other side then?

EG But knowing the lay out of the house.

RS Okay.

EG It's directly across from that window.

RS Okay.

EG Um about a minute, maybe two (2) or three (3) minutes later we see a barrel of a gun, which is black come out the window and we see it start moving and aiming our direction, we advise "gun, gun" and we cover the house, aim our guns at the house you know take aim at the, the window.

RS You still have your shotgun or?

EG I still have my shotgun, with single, or with one (1) out (inaudible).

RS Okay.

EG He, about that time, we yell "gun, gun" a shot was fired, immediately another shot and I heard a third (3rd) and check, I retreat back to the back of my vehicle to a safer location and ask everybody, "is everybody okay". Get an answer back, I come around to the drivers side and I see a hole or a uh shatter in the windshield.

RS Of your vehicle?

EG Correct of my vehicle.

RS Okay. And uh what did you guys do next?

EG We advised of the shots fired and stayed in our location and covered the house. The gun went back in the house after the third (3rd) shot.

RS Did you yell anything else out or anything, did you guys yell anything?

EG Not at that time no.

RS Okay.

EG I didn't hear anything.

RS Okay. Then what, what happens after that?

EG Other deputies arrive on scene to assist.

RS Okay and does anything else go on around the house while you're, you're still securing the perimeter?

EG As in did somebody leave or anything like that?

RS Did anything as far as with [REDACTED] or do you see people, I mean other people or anything like that?

EG No I don't, other deputies arrived.

RS Okay. Then you're relieved from there?

EG Exactly we were advised to moved back,

RS Okay.

EG Once the set team arrived.

RS Okay so Ed how long were you at position at those vehicles until uh you were relieved?

EG I believe it was about two (2) and a half hours.

RS Okay.

EG Maybe three (3).

RS Do you, is your shotgun in your vehicle?

EG It's in the back of Deputy Mabry's vehicle.

RS Okay.

EG As we retreated we left everything in the vehicle the way it was.

RS Okay. Did you shoot any rounds?

EG No I did not.

RS Okay. Um did anybody say that they returned fire when [REDACTED]

EG Oh after I asked if everybody was okay, um Sergeant Miller asked who shot, who fired, and it was Deputy Taylor said "I fired one (1) shot".

RS Did you say from what gun?

EG He didn't, I didn't under, I didn't know what gun, he didn't say, he just said he fired one (1) shot.

RS Okay.

EG He was, everybody on scene was either packing an AR and M sixteen (M16).

RS Okay.

EG Except for me I had this (inaudible) and a shotgun.

RS Okay. I noticed that when we were walking up here Ed that you were limping, what happened?

EG Um as I returned to get, seek cover behind the vehicle um I went down on my knee and it gave out, it went out, it's just,

RS Okay.

EG in a lot of pain so.

RS Okay.

EG At the time it was a lot of pain, it's wearing off now.

RS When, do you hear any more yelling or anything like that while this is going on?

EG I've heard yelling, I can't understand what he's saying.

RS Okay, okay and obviously since that time there's been more rounds fired, I've been hearing, I heard him fire off rounds and you've heard that also?

EG Correct.

RS Okay.

EG Just a few minutes ago.

RS Um is there anything else Ed that I can, you can think of that and I didn't ask you that would be important for me to know?

EG Oh I'm sorry, I forgot Deputy I believe it was Deputy Lundie showed up as well.

RS Lundie did, okay.

EG Right before the shots were fired.

RS Okay.

EG I'm not exactly sure of the timing exactly when he got there.

RS And to go back, you see, you see the rifle can you tell what type of gun it is at all or anything?

EG I can't, I can't tell. I see a rifle come out the window.

RS Okay. And um,

EG It, it was a loud gun I mean from even where we're at it was loud.

RS Okay.

EG And we were a good distance away.

RS Okay. Um and you, you, you hear two (2) shots fired,

EG Two (2) shots and there could have been a third (3rd).

RS Okay

EG But I, I heard one (1) closer to us I figured that was,

RS Okay.

EG But there may have been three (3) shots.

RS Okay. When, when that shot goes, does, do you see the gun pointed in your guys' direction?

EG Yes it was pointed in our direction?

RS Okay.

EG That's why we got cover by the doors and get as low as possible so he wouldn't have a target to shot at.

RS Okay. Alright I can't think of anything else Ed if you can't.

EG I can't no, nothing else.

RS Okay.

EG If I do I'll give you a sup on it or.

RS Alright we'll end the interview at twenty one twenty one (2121) hours.

End of transcript.

Transcribed by [REDACTED] 0608 on 1/2/2008.

HUMBOLDT COUNTY SHERIFF'S DEPARTMENT

CASE: 200703162
INTERVIEWER: Rich Schlesiger, Detective
SUBJECT: Attempt PC 187/ Officer Involved Shooting
STATEMENT OF: Matthew Spallino, Tribal Police
DATE & TIME: June 3, 2007 @ 2133 hours.
LOCATION: Hoopa, California

ALSO PRESENT:

RS Rich Schlesiger
MS Matthew Spallino

RS Okay date is June third, (3rd), two thousand seven (2007), time is twenty one thirty three (2133) hours, and your full name?

MS Matthew Spallino.

RS What's your middle initial?

MS "F".

RS S-P?

MS A-L-L-I-N-O.

RS Twenty five zero (250)?

MS Four (4).

RS Okay and your employed by Tribal Police Department?

MS Yes.

RS Matt how long have you been working for the Tribal Police Department now?

MS Uh a year for Hoopa and a year and a half for the Yurok's before I came up.

RS Okay. Okay when did you start your shift?

MS I got called out at four (4) o'clock from McKinleyville.

RS Okay is that where you reside?

MS Yes.

RS Okay. So you get called out of your residence, do you have a patrol car there?

MS Yeah.

RS Okay and um so you get called out at four (4) o'clock.

MS Right around four (4).

RS Okay and you respond from there right?

MS Right.

RS Okay uh what, what are you told when about the call?

MS Uh I was told that [REDACTED] I don't know his last name.

RS [REDACTED]

MS [REDACTED] [REDACTED] was barricaded inside a residence, and was armed with a firearm.

RS Okay. Was there anything else said?

MS That was it.

RS Okay. Did you respond Code three (3)?

MS I responded Code two and a half (2 ½).

RS Okay. So do you recall Matt about what time you got here?

MS I, I'm not real sure.

RS Okay. When you get here and this is called Bald Hill Road right?

MS Right.

RS Okay and um when you get here where, where do you go to from there?

MS I was advised that it was, there would be two (2) white poles at the end of the driveway, marked with tape, so I responded and parked behind the patrol vehicles that were already on scene.

RS Okay. Do you remember who was on, on scene Matt?

MS Uh Will Hostler, Ed Guyer and lets see,

RS Nolan?

MS And CHP Nolan.

RS Okay. Miller?

MS Yes Miller, Miller was here.

RS Okay. Were those cars parked, parked in the driveway?

MS Yes.

RS Okay how far back were you in that line?

MS I parked right behind the, right behind Sergeant Miller's car.

RS So there would have been four (4) or so?

MS Yeah.

RS Okay. Did, did anybody else arrive?

MS Uh Deputy Taylor arrived shortly after I did.

RS Okay and um what are you told when you, when you arrive?

MS That, well I heard over the scanner that he had went out on the front porch, was waiving a gun around, when I arrived I was told that he had came to the back window once and was yelling something,

RS And, and Officer Berry and or Deputy, Deputy Berry and Officer Landreneaux were here right?

MS Right, they were pinned down on the other side of the

RS Okay.

MS Residence.

RS Okay. And when you get out of your vehicle are you armed at that time?

MS Yes.

RS What are you armed with?

MS My AR and my duty forty (40) Glock forty (40).

RS Okay. Which one (1) did you have either of them drawn?

MS I had the AR in my hand.

RS Okay. And where did you take up a position at?

MS I took a position behind uh Chief Hostler's vehicle.

RS And where was that in the line of vehicles?

MS It was the first (1st) vehicle.

RS Okay, were you passenger, drivers side?

MS I was at the back at first and then uh Sergeant Miller advised that after forty seven (47) arrived for forty seven (47) to take one (1) door, I took the other and

RS Taylor?

MS Cover, Taylor and we covered the rear windows.

RS Okay. So you were where at on, in

MS I was passenger side.

RS Okay. Okay.

MS On the front vehicle.

RS And are you pointing your weapon at the, your AR at the uh,

MS At the residence, yes.

RS Okay and do you see anything at the residence, do you hear anything or anything like that?

MS Nothing, nothing at first (1st).

RS Okay. How long does it go by until you finally hear something or see something?

MS Approximately probably twenty (20) minutes after being behind the door, I observed the [REDACTED] come to the window with a red shirt on.

RS Okay did you recognize that person?

MS Yes.

RS Who was that person?

MS It was [REDACTED]

RS [REDACTED] [REDACTED]

MS [REDACTED] [REDACTED] yes.

RS Have you had dealings with him before?

MS Yes [REDACTED] approximately a week ago.

RS Okay. What was that encounter like?

MS Uh I was called out, Sergeant Guyer already had him detained before I got there but I was, the call was uh he had entered his parents, parents' residence and was mixing gas and something together.

RS Okay. Did you talk to him on this encounter at all?

MS I talked to him briefly when he was in the back of the car.

RS How was he acting?

MS Um he advised he was a uh [REDACTED] had lasers in his head, people were trying to kill him.

RS Okay. And who subsequently [REDACTED]

MS Uh the ambulance arrived I, I followed the ambulance till Arcata, they advised he was Code four (4) and took him the rest of the way.

RS Okay. Okay now back to today, were, were, you guys were there and um how much time passes before anything goes on?

MS Uh approximately probably a half hour.

RS Half hour?

MS Yeah.

RS Okay and what happens?

MS He comes to the window, he,

RS (Inaudible) red shirt?

MS Right. See him come to the window in a red shirt he hocks a "luggie" out the window and he, trying to think of what he said. He said he was going to get his M sixteen (M16) and, I can't remember his actual (inaudible) uh his exact words, he said something about he was going to get his M sixteen (M16) cap all of us if we don't move out.

RS Okay. What happens then?

MS Uh he left the window

RS Okay.

MS Approximately five (5) minutes later Deputy Taylor and I were covering the windows, Taylor advises he has a gun, I observed the gun sticking out of the window, but I couldn't see him.

RS What, what did the gun look like?

MS It, I could just see a black barrel sticking out.

RS Okay. Okay. Was it pointing towards you, away from you guys?

MS It was pointing towards us.

RS Okay so he could visible see that law enforcement was there?

MS Yes.

RS Okay. And uh what happened then?

MS Um shortly after I saw the barrel, he fired two (2) shots, I took cover behind, behind my door on the ground.

RS You heard two (2) shots?

MS I heard two (2) shots.

RS Did you see

MS I heard two (2) shots and then I heard Deputy Taylor fire one (1) in return.

RS What was he armed with?

MS He I believe it's an AR.

RS Okay and um, did you see the gunfire at all?

MS I didn't.

RS No you just heard the two (2) shots?

MS I heard the first shot and immediately went for cover.

RS And you had noticed before the gun was pointing right at you guys?

MS Right.

RS Okay and you hit, you ducked down, what happens after that?

MS Um like I said I heard the second (2nd) shot and then I heard Deputy Taylor fire one (1) shot in return.

RS Okay.

MS And where I was at behind the door I couldn't, had no more visible or you know.

RS Did you retreat from that point or what did you guys do next?

MS Um we stayed behind cover, Deputy Taylor was covering the window at this, that time Deputy Lundie was on scene he was right behind me um I moved to the rear of the vehicle, staged there.

RS Okay and was there anything else coming from the house, did you guys yell anything towards the house, anything else go on?

MS I don't recall if,

RS Okay did you ever see movement at the house after that at all?

MS No Deputy Taylor advised he shot the window and like I said where I was at I had no (inaudible).

RS That he, he shot the window or [REDACTED] shot the window?

MS That [REDACTED] shot the window after he had fired.

RS Okay.

MS [REDACTED] shot the window and then retreated back inside.

RS so you guys stood by there until you were relieved?

MS Right.

RS How long would you say you stood by?

MS I was approximately ten (10) minutes.

RS Okay.

MS Like I said, Deputy Lundie was at the rear of the vehicle with me and then that other SET Team guys arrived and they relieved me.

RS So how long was that?

MS I'm thinking approximately ten (10) minutes.

RS Oh okay so that quick.

MS Yeah.

RS Cause you came from McKinleyville?

MS Right.

RS So it was a longer drive. Okay I see. Um were you in a marked patrol unit?

MS Yes.

RS Okay and are you dressed like you are in full uniform right now?

MS Yes I am.

RS Okay. And did I ask you if you shot?

MS No you didn't but no I never fired.

RS Okay as far as you know you heard, did you see Deputy Taylor fire his shot?

MS No I heard the shot and he advised over the radio that he had returned fire.

RS Okay. Okay. Okay Matt is there anything else about the incident that, that I haven't asked you, you think would be important for me to know?

MS Um well the second part when the bullet went whizzing past us.

RS Well right that I should, that wasn't the only shots that have been fired.

MS Right.

RS And it happened, I don't, I don't recall what time I got here but when I was up here talking to some people I hear shots and then when we were down there talking he shot towards us.

MS Right.

RS Or ricochet or whatever happened.

MS Right.

RS Um so as far as you know, three (3) total shots fired, the first incident that you were there for?

MS The first incident.

RS Okay.

MS Although there were two (2) bullet holes in my window shield and one (1) in the windshield of the vehicle behind me so.

RS Okay. So

MS And there could have been three (3) like I say I mean I was just reacting you know.

RS There was two (2) in yours?

MS There, there's two (2) bullet holes in the front passenger,

RS Okay.

MS Of Will Hostler's vehicle, which I was behind the door.

RS And his was the first vehicle?

MS His is the front vehicle and then there's one (1) bullet hole in the vehicle right behind me, Sergeant Guyer's.

RS Okay and that was in the windshield?

MS And that's in the windshield as well.

RS Okay. Alright anything else Matt?

MS No I think that's,

RS Okay we'll end the interview at twenty one forty (2140).

End of transcript.

Transcribed on 1/2/2008 by [REDACTED] 0608.

HUMBOLDT COUNTY SHERIFF'S DEPARTMENT

CASE: 200703162
INTERVIEWER: Rich Schlesiger, Detective
SUBJECT: Attempt PC 187/ Officer Involved Shooting
STATEMENT OF: Mike Nolan, CHP.
DATE & TIME: June 3, 2007 @ 2208 hours.
LOCATION: Hoopa, California

ALSO PRESENT:

RS Rich Schlesiger
MN Mike Nolan.

RS Okay date is June third (3rd), two thousand seven (2007), time is twenty two zero eight (2208) hours. Mike what's your middle initial.

MN (Inaudible).

RS And your badge?

MN Eleven three ten (11310).

RS And you're a Highway Patrol man?

MN Yes.

RS How many years?

MN Twenty three (23),

RS Okay.

MN Or so.

RS Okay and were you working today?

MN Yes.

RS Okay and what was your shift?

MN Um fourteen hundred (1400) to twenty two thirty (2230).

RS Okay. And um how did you end up here on Bald Hill Road?

MN Dispatch gave me a call to assist the sheriff's department with a person at a house pointing a gun out at them.

RS Okay.

MN At about, it was about three thirty (330) or so.

RS Okay. And where did you respond from?

MN Um my house.

RS Okay and um do you remember recall what time you got here about?

MN Uh no I didn't look at it.

RS Okay and when you got here um who else was on scene when you arrived?

MN It was uh Ed Guyer, well on the way up here, I saw the Yurok officer's going down the hill, they didn't know where this location was, so they followed me up and I don't know their names.

RS Okay.

MN Um it was Ed Guyer, Willie Hostler and the other Hoopa Officer which,

RS Spallino?

MN I think it's Spallino, Spallino.

RS Yeah.

MN They were the one's on the driveway, they were the one's that I saw.

RS Okay.

MN And then I saw Mike Roberts later when I went up to the cross.

RS Okay. When you guys go down the driveway, um where were you parked at?

MN I was, I was directly behind the tribal officers, the two (2) SUV's.

RS Mm hmm.

MN And then um Yurok was down there and they were sent up to the cross but didn't know where it was, so I went up and showed them where it was and then I came back down.

RS Okay.

MN Cause my car was dragging rocks up there.

RS Okay. So when you come back down who's there then?

MN Hostler, Guyer, and Spallino.

RS Okay was Taylor on scene yet?

MN No.

RS Okay, um when you got out of your vehicle, what did you do then?

MN I um watched the, I guess they call it the south side of the house, which would be the back of the house, the trailer, and was on the drivers side of the second (2nd), the furthest back unit, just maintaining a perimeter.

RS So

MN (Inaudible) cover.

RS There's tribal, tribal then you?

MN There was a tribal SUV a newer one (1) and then uh the tribal SUV behind it and then when I parked, I parked up the embankment to allow cars to get around me if they needed, so my car was about twenty five (25) feet back or so against the embankment. I went up to the, the first tribal unit I came to and I stayed pretty much on the drivers side wedge of the door.

RS Okay and did you have any of your weapons' drawn?

MN I had the, the handgun was in the holster, and the um the AR was on my hip in the wedge of the door.

RS Okay. And um any uh from, from the house did you hear anything, did you guys yell anything towards the house, anything like that go on?

MN No not that I recall no. I saw um I heard some yelling from the house, we didn't say anything back.

RS What was the yelling?

MN I don't recall exactly what was said it was just yelling.

RS Okay. And uh what happened after that?

MN Um saw a guy in a, with a red on, look like red uh something on his head.

RS Did you recognize the guy at all?

MN No I don't know him.

RS Okay.

MN And then all um I didn't see what was pointed, it was, he was, like had something hanging out the window and all of a sudden you heard popping sounds.

RS Okay. Did you see a gun hanging out of the window?

MN I didn't see the gun no.

RS Okay. You saw something hanging out?

MN I saw him with his, his hands out the window, I didn't see what it was.

RS Okay. And uh how many popping sounds did you hear?

MN I heard it was either three (3) or four (4).

RS Okay. And what did you do when you heard those sounds?

MN I ducked.

RS Okay and after that what happened?

MN After I could smell uh, I could actually smell a smell and something, small little particles came over the, the wedge of the door, I remember little particle things

RS Okay.

MN And then I popped my head up a couple of times and by then the guy had left the window.

RS Okay. Did you notice anything about the vehicles, the patrol units?

MN I noticed uh after the fact that the, the one (1) I was standing next to had a hole in the window.

RS Okay. Did any of the other vehicles have any holes in them?

MN I didn't go up there.

RS Okay. Did you, did you guys retreat back or did you stay at that position you were at?

MN I went around to the back of the SUV to the passenger side, um the officer I was with the Tribal Officer Guyer um hurt his knee so he sort of hunched down on the drivers side back of the and I was on the passenger side.

RS Okay.

MN At the back of the SUV.

RS And you just stayed posted there until you were relieved?

MN I stayed posted there until yeah the um SWAT guys came.

RS How, how long was that Mike?

MN Time frame, it wasn't very long um Taylor had, was already there, Taylor was the first one (1) there and then a bunch of the other were in the back. I don't know any of their names, so I just know once, once

RS So the SWAT guys show up,

MN The shooting (inaudible) over with, they started coming up and they lined up on the left side of the cars,

RS Okay.

MN And then I went back to the, further back.

RS Okay, um and were you in a marked patrol car?

MN Yeah.

RS And are you dressed in full uniform like you are right now?

MN Yes.

RS Okay. Mike is there anything about that incident that I haven't asked you that would be important for me to know?

MN Just that before the actual shooting took effect, Taylor had worked his way up into a position where he was up at the front vehicle on the drivers side and Spallino was on the passenger side and Willie had gone back to brief the uh command personnel from the Sheriff's department so,

RS Okay.

MN A couple of little changes of personnel had taken effect.

RS Okay. And obviously you've been here for a while and so have I but there's been other rounds that have been shot that you've heard?

MN Yes.

RS Okay. I believe on at least two (2) different occasions?

MN Um the initial one (1) and then the one (1) that, there was a volley just before nine (9) o'clock, I'm not aware of any others.

RS Okay.

MN And I was not, I was back with the command personnel at that point.

RS Okay. Anything else Mike?

MN No that should do it.

RS Okay we'll end the interview at twenty two fifteen (2215).

End of transcript.

Transcribed on 1/4/08 by [REDACTED] 0608.

HUMBOLDT COUNTY SHERIFF'S DEPARTMENT

CASE: 200703162
INTERVIEWER: Rich Schlesiger, Detective
SUBJECT: Attempt PC 187/ Officer Involved Shooting
STATEMENT OF: Greg Berry, Deputy Sheriff
DATE & TIME: June 3, 2007 @ 2225 hours.
LOCATION: Hoopa, California

ALSO PRESENT:

RS Rich Schlesiger
GB Greg Berry

RS Okay date is June third (3rd) two thousand and seven, (2007), time is twenty two twenty five (2225) hours, Greg, I know how to spell that. What's your middle initial Greg?

GB "A".

RS B-E-R-R-Y.

GB Yeah.

RS Badge number or pin number?

GB Uh ten fifty five (1055).

RS Okay. And um you've been a deputy with us how long now?

GB Uh nine (9) years.

RS And before that you were employed somewhere?

GB Yeah I was with the City of Visalia for approximately ten (10) years, P.D.

RS Okay and um were, were you on duty today?

GB Yes.

RS What time did you start your shift?

GB Eight (8) o'clock.

RS Okay and when was that suppose to end?

GB Uh five (5) this afternoon.

RS Okay. And um how did you end up getting dispatched um up here to Bald Hill Road?

GB I was doubled with um twenty four zero two (2402) which is Heather Landreneaux of the Yurok Tribal Police.

RS Okay.

GB Um she got a brand new patrol expedition and I wanted her to take me for a ride, so we went to Orleans to do some follow up on an arson and post some reward posters from the tribe when we got a call to this location on Bald Hill Road in Hoopa to check the welfare of a possible [REDACTED] they gave us the name and they said that there was no Hoopa Tribal unit available to respond because he had a uh in custody on his way over to the jail.

RS Mm hmm.

GB So we came here, as we were, we got directions to the residence and on our way up this road, Bald Hill Road here we past a [REDACTED] pickup truck containing [REDACTED] uh which was one (1) of the reporting parties, the person that lives in the residence.

RS Okay.

GB Okay she immediately expresses to us that she turns around and waves us over and she says there's more coming than you two (2) right and you have an ambulance right, and I said well I don't know what we're getting into come talk to us, so we got out of the trucks and

RS Where were you at exactly Greg (inaudible)?

GB Well it was approximately half a mile back from this driveway.

RS Okay.

GB Just around the corner at a pull out.

RS Okay, okay and you guys responded from Orleans right?

GB From Orleans yeah so it took us you know probably forty (40) minutes to get here and then we had to find, find the place, so she's talking to us and she kind of tells us the back ground of this guy and she says that um

RS Do you know what time you got the call?

GB We got the call at approximately, I can only guess two thirty (2:30) in the afternoon or maybe even before that it might have been closer to two (2) because we didn't get here until just before three (3) o'clock,

RS Okay.

GB And we talked to her for several, probably twenty (20) minutes down here, [REDACTED]
[REDACTED]

RS And what did [REDACTED] tell you when you (inaudible)?

GB She told us that she's known this kid for, this, the per, the [REDACTED] for a long time um
[REDACTED]

RS [REDACTED]

GB [REDACTED] yeah that's him.

RS Do you know him at all?

GB No never, never had a dealing with him and that they haven't seen him or really had contact with him socially for four (4) to five (5) years and all of a sudden today he shows up at the residence uh wanting a place to sleep and all of this so she gets on the phone to [REDACTED] mother, [REDACTED] mother tells her we need to have somebody come out and he needs to go back to [REDACTED] because he's, at some point prior to today, and I don't know if it was yesterday or when, he's said that he had a dream and he was making threats to harm the mothers youngest child in some way.

RS Okay did you talk to [REDACTED] at all?

GB Who's [REDACTED]

RS The mom.

GB The mom, I talked to her briefly on the phone and I said basically what, what's, what is it about this situation that [REDACTED], has he threatened you or anybody else specifically, what specific threats are they, is he saying the words I'm going to hurt

somebody or I'm going to hurt myself or I want to kill myself, is he saying those kind of things and she never really would say any of that came out however she did say [REDACTED] because he made this threat against the young child and it was off the wall and that he apparently had done a lot of damage to I think it was his brothers residence or something, his brother was trying to help him out there was, there was some other male, a family member and basically [REDACTED] [REDACTED] [REDACTED] there was um talking delusional and saying some, some weird things and so this brother or person, who ever it was I think she said his name was [REDACTED], the man that was trying to help this guy,

RS [REDACTED]

GB [REDACTED]

RS Okay.

GB He'd done a lot of damage to his house and what not so [REDACTED] basically just, he was giving him a ride and said hey I can't have you doing this, you need to get out of the truck, so then he gets out of the truck and then some how or another walks up here and shows

RS Okay.

GB At this residence, so I wasn't really happy with the things that the mom was saying about you know how he's acting and uh the number issue involved cause it was just me and Heather Landreneaux here together, we didn't have any other back up anywhere in the area,

RS Mm hmm.

GB So I heard Mike Robert of the Tribal Police clear the jail and I got him on the cell phone, okay in the mean time, while speaking to the mother, I asked the mother,

RS On the phone?

GB On the phone.

RS Okay.

GB Before calling Mike Roberts, I asked the mother I said well how, how is [REDACTED] towards law enforcement when we go up there is he going to fight us and she said no, I don't think so because he's Mike Roberts is aware of the case and he's Mike Roberts had some contact prior with him where he was totally cooperative, he wasn't a problem not making threats to officers or anything like that. So I thought okay now it was after this point that I phoned Mike Roberts on, on his cell phone and basically told him what we had and um he was going to start coming this way but he was clear over in the corridor on, in Arcata by the CHP Office so it was going to take him awhile

RS Yeah

GB To get here, so I told [REDACTED] that okay Heather and I will go up and make contact with him, we'll see how [REDACTED] is, see if he's you know says the right things to us that we can either talk to him and get [REDACTED] like he, yeah he really wants to hurt himself or he's gonna do something to somebody else, [REDACTED] Okay so I radio, we radioed that we were enroute, we were following her, she said I will show you the drive way but I'm not going in there because I have my kids with me and I don't want them there and we said that's fine,

RS Why, why was she so worried?

GB Cause of the things he was saying, apparently he was saying, talking to himself, he was talking in some kind of apparently, [REDACTED] her live in boyfriend or husband, I don't know anyway he's got sleep apnea so he has this breathing thing that he sleeps with and apparently [REDACTED] was like talking into that and um just saying something like he was talking to people that weren't there, you know,

RS Okay.

GB You know talking to an imaginary friend or something.

RS Okay.

GB Um and that he, just his behavior was threatening and he was saying stuff like he didn't want to be around anymore and you know and I told her at that time well that could be taken to mean several different things but you know we'll just have to go see what it's like and then we'll play it by ear from there.

RS Mm hmm.

GB Um so that was fine, she said follow me up to where the driveway is and then I'll, I'll tell you how to get to the house, it's real easy and then I'm gonna, I'm gonna stay out here or something, okay. So she pulled up, we, she pointed the driveway to us so we drove down the driveway and she says, it's a [REDACTED] house, just done the road here, it's a trailer, it's a [REDACTED] trailer and they're, they're both in there, [REDACTED] and [REDACTED]

RS Okay.

GB Okay so we pull around the corner up here and we see a [REDACTED] trailer on the right with an add on, but then further up the road we see another residence that looks [REDACTED] so we weren't sure

which residence we were suppose to be at so as we pull past the front or basically the side of the, this, this trailer, where they're in now, um we see two (2) males standing out front on the porch.

RS Okay.

GB Okay [REDACTED] was standing more towards the on the ground on the front of the porch and [REDACTED] [REDACTED] was standing up on the porch out side of the front door so we, Heather pulled, Heather was driving she pulled her unit around there where we were facing him with the front of the vehicle in the front door.

RS Mm hmm.

GB [REDACTED] is now standing at the passenger door and I'm talking to him,

RS How far are you guys away from him (inaudible).

GB We're roughly, roughly thirty (30) to forty (40) feet, you know we,

RS So you're pretty close.

GB We're pretty close, too close. So realizing that we're at the right place, [REDACTED] comes to the drive, to the passenger door and starts talking to me and, and, [REDACTED] gives some indication to him saying, what, what, why are these guys here and [REDACTED] turns around and says well I think these guys need to talk to you, it was at that point that immediately [REDACTED] starts pulling knives out of I don't know where, either his pockets or his waist band or something and he's putting them in view where we can see them in his belt.

RS Mm hmm.

GB He must have four (4) to five (5) knives on him.

RS Like having the handle sticking out of his waistband?

GB Yeah, yeah he's having them and he's putting, I remember seeing him put two (2) that were pointing towards each other towards the front of his belt,

RS Okay.

GB I remember seeing that. I told him at that point, Heather ordered him to drop the knives, he wasn't doing it um after several moments and I don't know how long it was of him standing there, he never advanced towards us, he went back inside the residence and shut the door. When he did that,

RS Did he say anything to you guys?

GB He just said that he was, he was pissed off at [REDACTED] and he says I'm pissed off at you now um you mother fuckers get out of here, I don't want you here referring to us me and Heather.

RS Okay.

GB So he then shuts the door and goes somewhere in to the residence so [REDACTED] now walks around to Heathers side of the vehicle and on Heathers side of the vehicle, within probably fifteen (15) feet is a bedroom window, sliding bedroom window us or facing basically the drivers side of the vehicle and it's closed.

RS So you guys are parked right up against the house then?

GB Yeah well we're, we're pretty close to the house, cause it's a short driveway, little short driveway once you makes the turn off the road.

RS Okay.

GB So as I'm standing on the passengers side, I believe I was getting ready to get on the radio because my attention was drawn in to, into the interior of the patrol vehicle I hear [REDACTED] yell out to Heather um that he's in there and he's pointing a gun at you guys and so I look and I couldn't see anything through the glare of the window, apparently he was doing this while he was inside the window, I got an indication from Heather and I don't know if she actually saw this because I don't know but she indicated that to me that what [REDACTED] said was true, there was, there was a feeling on our part that this was actual, he was actually pointing a firearm at us, I wasn't going to take any chances I took cover.

RS Okay.

GB Um so at that point um I radio to dispatch that [REDACTED] is, is in the residence and he's pointing firearms at us.

RS Okay.

GB Okay. I then go to the cover of the rear of the vehicle where I'm behind two (2) steel cages, (inaudible).

RS Where, okay so there's the house, you're parked on the south side of the house?

GB We're parked on the north side of the house.

RS North side, so you're all the way around?

GB We're all the way around the other side of the residence.

RS Okay, okay I see.

GB From the entrance to the road, from the roadway.

RS And so you're facing east?

GB We're facing south.

RS Okay so you're parked towards the house.

GB We did a complete "U" in the driveway.

RS Okay.

GB To get off of the, the road, main road. We do a complete "U" to face the front of the house, which is facing north.

RS Okay.

GB Um Heather and [REDACTED] then come to my location as well and we're taking cover behind the engine block and the two (2) cages.

RS Okay.

GB Cause if he's pointing a gun at us, that's the only safe place to be.

RS Okay.

GB Um [REDACTED] indicates somehow that he, he says I don't know where he got the gun, I locked up all my guns and I said well what guns do you have, he says I have a twenty two (22) rifle with a scope and that's what I think he's got, um he says I also have an AK forty seven (47) and a AR fifteen (15) that I hope I don't get in trouble for because I bought them back in the eighties (80's) before that law went and I said I'm not worried about that right now, um and he said he had a forty five (45) pistol in there but that they were locked in a gun safe and to his knowledge, the best of his knowledge there was no ammunition available outside of the gun safe. So and that he didn't, he was pretty sure that there was no ammunition for the twenty two (22) rifle but he wasn't positive. Only a few moments goes by Heather is now, we've, we've switched positions to where Heather is on the passengers side of the vehicle and I'm over on the driver side of the vehicle behind it looking at that window and taking cover, she then yells out that he's at the front door with the, with a rifle or he's pointing a firearm at us.

RS And how far are you guys from the front door?

GB We're thirty (30) to forty (40) feet.

RS Okay do you see this?

GB Yeah I see it, I see this rifle, he's, he's leveled right off at the vehicle um and [REDACTED] confirmed the same thing verbally to us that yeah he's point it right at you, he's pointing it right at us and um he does this for several moments, he's telling us to just get out, go away um and he's clicking it, he's chalking it and clicking it, we can hear, we can hear that, the clicking of the, the action.

RS (Inaudible).

GB The bolt or something on it, so I then get on the public address system and I, he shuts the door, he goes back inside, so I get on the public address system and I'm trying, I'm talking to him really nice, I'm saying hey [REDACTED] you know we, we just want to talk to you, we're not going to take you to jail you know, you're not in any trouble or nothing, we just want to talk to you and see what, how we can help you and you know we're not here, you're not in any kind of trouble what so ever you know just come, come out and talk to us but you can't, we can't have you being have a knives and having guns pointing at us. He then comes out again, opens the door and he, he's pointing the gun again for like several minutes and we can hear clicking, so

RS And you can see this?

GB I can see this, clearly.

RS So he's just walking right out on to the front porch then?

GB Mm hmm or standing in the open doorway pretty much is what he's doing,

RS Okay.

GB So I told Heather I said to her, we are in a bad tactical situation, we are pinned down, I am going to start your vehicle and I started it front the passengers side cause her keys were in the ignition, I said I'm gonna start this vehicle and one (1) of us needs to get in there and back this thing up the road, to where not only we can get behind better cover, we can be farther away and we can still watch that door and that window, so [REDACTED] stayed at the rear of the vehicle and I said I'm gonna back this thing up real slow so just be aware, so I snuck in to the drivers compartment and ducked down behind the dash and I was able to look in the mirror and slowly back this thing up the road, north, northbound facing a southbound direction.

RS Okay.

GB So I was able to get the vehicle probably a hundred feet up the road and he opened the door again and came out with the, with the rifle so I stopped the vehicle,

RS Did he come, how far out did he come?

GB He, I, I believe he stood just right in the doorway, I don't think he stepped out on to the porch at that point.

RS Did he point it again?

GB Yes he did.

RS Okay.

GB And it was at that time that,

RS How's he pointing it?

GB Oh he's got it leveled off,

RS Okay.

GB Like he's aiming down a sight or looking in a scope

RS Okay.

GB He's got it up to his head and it's pointing directly at the vehicle.

RS Okay.

GB So it was at this point that Heather and I didn't see this, Heather and [REDACTED] both yelled out that he's got a pistol at this, at this point and I didn't see that. All I say was the rifle cause I was trying to keep hidden behind the, all I had was the door metal of the drivers door, I didn't have really any good cover, so I said well I, I'm still not comfortable, we need to back this thing further up the road, so I snuck around to the drivers door again and go inside and put it in reverse and backed up probably another one hundred (100) feet.

RS And when you're backing up is it on the road or?

GB It's on the main dirt road that goes by the residence,

RS Okay so you're backing back down then kind of?

GB No, we're backing up, mm what can I, okay verbally the, the, the dirt road that leaves the pavement goes around this corner, this curve to the north, from the east,

RS This road right here?

GB From this road right here, from Bald Hill,

RS Okay.

GB It curves to the from the east to the north and faces north and then it continues on but when it continues on further up the, the road, their little driveway is just uh like a, you have to do a "U" to the right to pull into it, and the driveway's probably only from where you leave the main dirt road, the driveway is only probably forty (40) feet long at the most, okay and then that road continues on up to [REDACTED] residence which is the end of the road.

RS Okay.

GB You can't go any further up that road, and all there is, is blackberries on both sides of road, there's no real cover there, so I backed up probably hundred feet to where we were a good, I would say at least two hundred and fifty (250) to three hundred (300) feet from the front door of the residence, we could still see the front door and we could still see that window and that's when we radioed for a bunch more support.

RS Okay. So how long after you radio, radio for more support is it until people get there?

GB I told dispatch to have the units that were responding to expedite because of what was going on. Twenty (20) uh Mike Roberts was on two ninety nine (299) on his way over and started coming Code three (3) but he was probably only at Lord Ellis at that particular time, I, I'm not sure of that but that's a guess, it happened that Heather's partner's swing shift partner's came on duty and were coming to the area but I don't know who arrived first (1st) but I could say that it was a good at least forty five (45) minutes to maybe an hour before we got anybody else on another perimeter of the residence. The only view of the residence was the north.

RS Did you see the, the male [REDACTED] anymore?

GB Yes several times, there were many times,

RS Could he see you?

GB He couldn't see uh because we were behind cover.

RS Okay.

GB But he could definitely see the vehicle.

RS Okay.

GB He definitely had a straight shot of the vehicle um,

RS What was he doing when he was coming out?

GB Every time he'd come out, he would point, he would level off that rifle at the vehicle, we could see that and, and you could hear that click, even from that far away, you could hear that thing clicking and he, he was either activating the action on it or he was clicking the trigger, he was doing something. He was definitely using that rifle and he was definitely pointing it, leveling it directly at us.

RS How many times did that happen Greg; that he came back out while you guys were waiting?

GB I can only estimate um, at least eight (8) to ten (10) times.

RS Okay and during this time did you draw any of your duty weapons?

GB Yes, yes we did, I had my pistol, my forty (40) caliber with me, I had that out, and before we got um the, the SWAT Team and, and the real you know support here, uh I told Heather I said we need to try to get your shotgun out of there and we need to make sure it's loaded with slugs because being that I was in her vehicle and we were, were driving her vehicle, she does not have issued to her a long range rifle, and I left mine in my Expedition so we didn't have anything with any kind of range on it.

RS Okay.

GB So she got up, snuck up to the front, got the shotgun out, we brought it back she got a spare ammunition out of the back, and we were able to load the whole thing with uh slugs in case the man came out running towards us, instead of just standing in the doorway, running towards us trying to ambush us.

RS Okay.

GB At least we've got some protection there you know that would be better than a pistol at long range um,

RS Did you arm your self with that or did?

GB We both had it at different times.

RS Okay.

GB We were trading off because we could get tired of holding it you know pointing it and watching the door and so we were basically just trading it off.

RS Okay.

GB I had it most of the time though.

RS So after about an hour and he comes out several times pointing the gun towards the vehicle, the other guys arrive, do you know who the other guys were?

GB I know that twenty five zero (250) or Mike Roberts was somewhere, and I don't know where exactly, I know now because I walked by his vehicle up here but somewhere to the east of me um watching the residence and he could see the window, the man had pointed the rifle out but he couldn't see the front door, so I knew that that part of the residence was covered, at least part of it. Uh it was that, later within probably another half hour, or twenty (20) minutes, I don't know if even if it's that long, that Hoopa Tribal units were called um Willie Hostler and Ed Guyer and they showed up and they were on the south part of the residence watching it.

RS Okay.

GB Um but we were still in a position where we couldn't go, there were no escapes for me and Heather,

RS Okay.

GB Nowhere for us to go.

RS Okay. And during this time while you're, you're stationed out there, uh do you ever hear any shots?

GB No. At that time there were no shots fired ever, the only, the first time I ever heard a shot fired was when Bryan Taylor arrived on the scene and was positioned somewhere, somewhere to the east of the residence, and I don't know where exactly but that was the first time I heard and then we had heard that there were shots fired and that there two (2) of the police units that had been hit.

RS Did you hear any shots?

GB Yes.

RS How many shots did you hear?

GB I heard, I believe a total of four (4).

RS Okay and uh have you heard anymore after that?

GB Yes.

RS Okay.

GB Um after the, the SWAT Team guys arrived and snuck up behind us undercover, um Heather and I were gonna come with the key to Officer Lundie's car, cause Officer Lundie was gonna take Heather's car home, when this was, when we were done here and then Heather and I were gonna drive his patrol car out of here to get mine and then go home. So that was arranged and we had arranged to go leave, leave that scene cause we were relieved by then, go up to [REDACTED] residence and either make contact with the witness [REDACTED] or see where he had gone. Um so we went to [REDACTED] residence first and talked to him and he said well he's not here, and we had seen [REDACTED] walking through the, the brush over the hill coming eastbound, leaving the area and he had some blankets on, he was not feeling well, he apparently was bitten by a spider today at some point and he was feeling sick. So he was cold and he wanted to leave and we thought that maybe it was best that he did leave, because he was, we were all still in a pretty dangerous situation.

RS Okay.

GB Um so when Heather and I decided that okay we still got enough light that we're gonna try, we're gonna get out of here and get around the hillside to where we're under cover of the, of the hill um we're going to leave, so we started to leave and, and walk away from the vehicle when we heard more shots and we went then ran back to the vehicle to get behind the cover of the, the steel.

RS That's the one's (1's) probably around nine (9) o'clock?

GB Yeah that was the one's about nine (9) o'clock, where um I don't know he had apparently shot out the window or something, I'm not sure what happened, I don't know who shot who.

RS You never saw any (inaudible).

GB I never saw any of that all I, all it was for on my part was these things were heard, and I believe I heard about three (3) shots.

RS Okay. Greg did you ever fire any of your weapons?

GB Nope never.

RS Uh anyone with you ever fire any

GB Nope.

RS Of there weapons. Um do you know, where, where is the shotgun at now, is it still in Heather's?

GB No it's in, I put um we secured it in the back of Lundie's rig.

RS Okay, okay. Um when he's leveling the gun off with you, at, at you guys, what, what do you think his intent was?

GB I fully feel that his intent was to shot both of us cause there was one (1) point that he told us, I told him that we were going to back the truck up, that we didn't like people pointing guns at us and that we were going to back the truck up and you know basically leave. I told him we were going to leave, you know just to get him to calm down and not be pointing guns at us anymore, he then opens the door again, with the gun and he's leveled it off at us and he's telling us and he's telling us, you go ahead and leave, take off running, that rigs ours' now, you're not taking it, I'm, I'm taking that rig and your not getting it so you take off running, you get, you mother fuckers get out of here, you're pissing me off and I don't want you here.

RS Okay.

GB Um so it was after that point that I backed it further up the road um to get it out basically out of the driveway and get some distance between us.

RS These conversations he's having with you guys, I mean does it appear that he's [REDACTED]

GB Oh yeah, I mean he's definitely you know he's, he's definitely put himself in a position of harm, he's put us in a position of harm um I this, through this whole entire incident I had fear for my life and my safety and Heather's and [REDACTED]

RS Okay.

GB I had every belief in my heart and mind that this man, if he found bullets he was going to kill us.

RS Okay um the vehicle you drive up in, is it, is it marked, is it a marked Yurok?

GB Yes. It's a marked a Yurok Police unit, it has stickers and it says Yurok Tribe, Public Safety on it and it's fully equipped with police lights and siren and all the equipment, the radio equipment and everything that's necessary.

RS And were you uh dressed in full uniform like you are right now?

GB Yes, both Heather and I were.

RS Okay. Greg is there anything else I haven't asked you that you think would be important for me to know?

GB Um just some statements, on the part of [REDACTED] with regards to the things that [REDACTED] was saying prior such as you know [REDACTED] last week, or whenever it was and I'm not going back to that place, and they're going to have to, they're going to have to kill me. I'm not going back alive, I'm not alive is what is was relayed to us through [REDACTED]

RS Okay. Alright. Anything else Greg?

GB There was at some point during, prior to the arrival of Sheriff's support when it was only Heather and I and the other Hoopa Tribal units that were around the house, I was told by Ed, Ed Guyer on the radio that Mr. [REDACTED] [REDACTED] inside the residence was making several cell phone calls to [REDACTED] now I don't know what those conversations, I don't know anything about those conversations but he just told me he's been making calls to her all this time. [REDACTED] [REDACTED] hears this on the radio and he indicates, I don't know where he got a phone, I didn't know there was a cell phone in there or if he had one (1) on him I didn't know it but he's apparently got one (1) now. Uh I said well he's making phone calls so and I asked him does he have a scanner, of course he says no we don't have a scanner so that was good for us.

RS Okay. Anything else?

GB I can't think of anything else Rich.

RS Alright, I don't think I can either.

GB My brain's pretty spent at this point.

RS I bet. Okay we'll end the interview twenty two fifty five (2255) hours.

End of transcript.

Transcribed on 1/3/2008 by [REDACTED] 0608.

HUMBOLDT COUNTY SHERIFF'S DEPARTMENT

CASE: 200703162
INTERVIEWER: Rich Schlesiger, Detective
SUBJECT: Attempt PC 187/ Officer Involved Shooting
STATEMENT OF: Heather Landreneaux, Officer
DATE & TIME: June 3, 2007 @ 2325 hours.
LOCATION: Hoopa, California

ALSO PRESENT:

RS Rich Schlesiger
HL Heather Landreneaux

RS Okay date is June third (3rd) two thousand seven (2007), time is twenty three twenty five (2325 hours), Heather, what's your middle initial Heather?

HL "M"

RS And spell your last name?

HL L-A-N-D-R-E-N-E-A-U-X.

RS And uh your badge number?

HL Um my pin number is fifteen fifty four (1554).

RS What's your call sign?

HL Twenty four zero two (2402).

RS Okay. You, you work for the Yurok Police Department?

HL Yes sir.

RS Okay and how long have you been doing that?

HL Four (4) years.

RS Okay, is that the only place you've worked so far?

HL Yes.

RS Okay.

HL I have worked reserve for Del Norte County Sheriff's Department also.

RS Okay and um we're you working today?

HL Yes.

RS What time did you come on?

HL Ten (10) o'clock.

RS And when were you suppose to end?

HL Eight (8) o'clock.

RS Eight (8) o'clock. Okay and um from, I've already talked to Deputy Berry, you guys were doubled up in Orleans?

HL Yes.

RS In your patrol vehicle?

HL In my patrol vehicle.

RS Okay take me from that point on, what happens?

HL Oh we got a call for uh welfare check.

RS Okay do you recall what time it was?

HL No I don't.

RS Okay.

HL We got a call for a welfare check, we responded from the Orleans area and came up this road, we actually past it cause I wasn't sure where we were we going, came up this road.

RS And you were in your patrol unit right?

HL Yes and I was driving.

RS You were driving, okay.

HL And we saw, as we're coming up this road we saw a vehicle uh [REDACTED] pickup truck drive past us and Berry alerted me that they were turning around and probably wanted to talk to us, so I pulled over and she said that she was the RP and that it was at her house and she was told to wait by her gate that she decided that she was going to go wait at the bottom of the hill.

RS Okay.

HL So she turned around, came back up,

RS How, how far down were you guys or up, when you met her, was it [REDACTED]

HL [REDACTED] yes, um we were probably one (1) turn back from here.

RS Okay.

HL So not very far uh there's a little side road that we pulled into so that we would be off the roadway, she pulled in behind us and we got out and talked to her, when she said that she could, she had contact with his mother on cell phone so Berry took her cell phone and was talking to her at the front of my vehicle, and I continued to talk to her I got her name, date of birth and all that information, and kind of was talking to her about what was going on and she said that [REDACTED]
[REDACTED]

RS Did she say who she was?

HL [REDACTED] and that he'd known, she'd known him since he was a little boy, hadn't seen him for quite a few years and he just appeared today out of nowhere and was dehydrated.

RS Does [REDACTED] sound more like it?

HL Yeah sorry.

RS Okay.

HL What did I call him?

RS [REDACTED]

HL Okay. Yeah [REDACTED] um he had appeared at her house, dehydrated she hadn't seen him for a couple of years so,

RS She hadn't seen him for a couple years?

HL That's what she said.

RS Okay.

HL Um one (1) of the kids in the back said that he had a knife that looked like a cross and that it was his sock and uh so I talked to her a little bit more.

RS What, what, what was she telling you, why was she so worried?

HL She was worried because apparently he had been talking to his mother and he had been making threats to his mom um she didn't have anything exact, statements or anything but said that she was afraid because he just didn't look right and he didn't seem like he right in the head, she knew that [REDACTED]. She said that he made statements like he didn't belong somewhere, um not necessarily threatening statements or that he wanted to hurt himself or others, but it could have been one (1) or the other.

RS Okay.

HL Um not real definite statements, she said that he had threatened her however she was afraid and so she wanted to take her boys down and leave the residence.

RS Okay.

HL She also said that um her husband was the only person, other person inside the residence with him.

RS Okay.

HL She said it be, she would take us to the gate, which is the two (2) white fence posts,

RS Okay.

HL And that um she would wait out here cause she didn't want to go back to the residence and we said um we'd prefer you not to go back and um she said it would be easy to find because it was the, it was a [REDACTED] trailer,

RS Okay.

HL And when we drove up, we could see a [REDACTED] house or trailer in front of us and then a [REDACTED] trailer house by the side uh as we're driving in, so we weren't really sure which [REDACTED] place that we were going to.

RS And at this time there was no there cops with you guys right?

HL No it's just Berry and I.

RS Okay.

HL So we pulled into the driveway cause one (1), one (1) of the guys came out um,

RS [REDACTED]

HL [REDACTED] yeah, I don't remember his first name he was, he came out of the residence and we were going to ask him you know if it was this house or the next house and at that point is when [REDACTED] came to the door and I had my door open, Berry was talking to um [REDACTED] and also on the radio and he pulled two (2) knives from his waist belt and they looked like butter knives but I couldn't be sure um and he started waiving them around and (inaudible).

RS Butter knives or butterfly knives?

HL They, I couldn't tell,

RS (Inaudible) just like a butter knife then?

HL It, it, it was, it looked like two (2), they were two (2) knives

RS Okay, okay.

HL They were long and silver, they didn't have handles that were distinct on them.

RS Okay. Okay one (1) thing Heather when, when you guys pull up there, the house is, so when you're driving down this gravel road the house is actually on the north side of the road?

HL Yes.

RS Okay then you guys kind of looped around all over to the north side of the house?

HL Yes.

RS And then met with [REDACTED]

HL With [REDACTED] who,

RS And how's your vehicle parked?

HL My vehicle was parked right in the driveway um so that we had a good visual on the,

RS So you would have been facing which way?

HL We would have been facing the front door of the house.

RS Would that be north southeast?

HL That would be facing,

RS East okay

HL That direction, east. Sorry I'm not real good with direction, I got all disoriented um so we were facing east, he, I yelled at him you know,

RS And the front doors out, right out there?

HL The front door is yeah,

RS How far away are you guys from the front door?

HL Probably thirty (30) feet.

RS Okay.

HL (Inaudible) we weren't too far um I yelled at him to put the knives down, put the knives down, he put the knives back into his belt and he was fidgeting around in other places where appeared he had other weapons, um

RS Was he complying at all?

HL With that command of putting the knives down, that's as close as putting them down as he did, he did get them out of his hand,

RS Okay.

HL Berry then got on the radio and advised Dispatch of what was going on.

RS What was [REDACTED] telling you guys during this time?

HL [REDACTED] was telling us that you know he's been crazy, he just showed up at the house, um just kind of giving us a little info. He was a little worried he had been sleeping and he thought that um we showed up at perfect timing because we could have got him when he was sleeping and he really didn't want him there um and he's just been acting really crazy and weird and saying weird things, talking to himself, talking into things and

RS Was there any mention of guns or anything.

HL Not until later.

RS Okay so go ahead from that point.

HL So he started backing into the door and I yelled at him to stay where he could, we could see him and he shut the door all the way um that's when [REDACTED] started telling us that he has guns in the house, he had one (1) gun out that wasn't loaded and several guns inside of a gun safe.

RS Did he, what gun was out that wasn't loaded?

HL The twenty two (22) rifle.

RS Okay.

HL He said that the twenty two (22) ammunition was in a drawer, it wasn't right next to the rifle that he wasn't he, he was pretty sure that the guy didn't know where it was,

RS Okay.

HL Where uh [REDACTED] didn't know where it was.

RS But there was other guns in a safe?

HL There was other guns in a safe?

RS Did he mention what type of guns?

HL He mentioned that he had a shotgun and a rifle and then said he didn't want to get in trouble because he's got an AR in there but the AR didn't have but a few rounds and he started telling us about how many rounds he had which was still quite a few, and he said he had a AK forty seven (47),

RS And a pistol?

HL And, he said that he had a bunch of guns and that they were all locked up, I don't recall him saying that he had a pistol.

RS Okay, okay, okay.

HL Um actually he said that they're might be a toy gun in there and uh so he came to, as he's telling us this, he came to the window which is closest to the door, we could only see three (3) windows.

RS The front door?

HL Not the closest to the front door, closest to where we are.

RS You door, so looking at the house, would it be farthest to the left, right, middle?

HL Well there's the door here, then there's a window here that points this direction,

RS Okay.

HL And then it's,

RS So it's kind of on the side then?

HL And then it's pointed, it's pointed, the only easterly pointing window.

RS Okay.

HL And he was pointing, he pointed a gun at us.

RS Did you see that?

HL I did see that.

RS What did you see?

HL I, I saw him pointing what appeared to be a rifle.

RS Okay.

HL At, at us.

RS Directly at you guys?

HL Directly at us.

RS How was he holding it?

HL He was holding it up like this,

RS So,

HL But before, let me back up, when he backed into the house, he was doing this.

RS With his hands?

HL With his fingers, making guns like he was shooting.

RS Okay.

HL So then um, then he went into the house.

RS With that window open?

HL No it was shut.

RS No, but you could see through the window and he had it leveled up, off up at his eyes?

HL Right.

RS Okay.

HL At, at that point there wasn't a glare on the window and we could see clearly inside of that window.

RS Okay.

HL And he pointed the rifle at us and then he would back, you know backed away and he's come back out and we'd already drawn our weapons and,

RS What did you have drawn?

HL I had my um my side arm.

RS Okay. Did, what did Deputy Berry have drawn?

HL His side arm.

RS And were guys yelling at him or anything like that?

HL Yes.

RS What were you saying?

HL Oh we were telling him to drop the weapon and come out where we can,

RS What was he saying during this time?

HL I couldn't understand.

RS Okay.

HL What he was saying, (inaudible).

RS What, what do you mean couldn't understand?

HL It was muffled.

RS Okay

HL Um cause like you said the window was shut, couldn't really

RS Did he say anything outside of the house, the first time?

HL Yeah he told us to go away several times, told us to go away.

RS Okay.

HL Um and I can't recall anything else that he said at this point.

RS Okay.

HL I know he was telling us to just go away.

RS So he's, he's up at the window he comes back and forth a couple times?

HL He comes back and forth once or twice as we're going holy crap um cause we knew we were in a bad situation um we knew we needed to get back farther and uh so when he went back in the house and we couldn't see him we (inaudible) up Berry (inaudible) up from the, we had took cover behind the rear of my patrol vehicle,

RS Okay.

HL He crept up to the drivers side, actually I did first, and backed up um probably another

RS You back you're,

HL I backed my first, first I backed it up another thirty (30) feet or so and then um when he came to the front door, he shot the, or he pointed the rifle at us again.

RS Okay so he, how far outside of the front door is he standing?

HL Well probably, outside of the front, he was right in the doorway.

RS Okay and you guys had your guns pointed at him?

HL We had our guns pointed at him.

RS Were you saying anything to him?

HL We were telling him to drop the weapon.

RS Okay. Um was he doing anything with the gun?

HL He was holding it and aiming it and pointing it, he'd um, [REDACTED] had told us it had a scope on it.

RS Okay.

HL Um but he wasn't sure if he had any ammunition at that point.

RS Okay.

HL Because the ammunition was suppose to be locked in a drawer and he was pretty sure that he didn't have um any other guns, he came out again and it appeared that he had a pistol in his hand and [REDACTED] had said I think that's a toy gun cause I don't think I own any pistols.

RS Okay. What did he do then?

HL He pointed the gun at us again, we again yelled at him to drop the weapon and stay where we can see, where we could see him and he went back in the house, he was kind of taunting us a little bit,

RS What do you, explain that to me.

HL Kind of making jesters like come on shot me,

RS Come on, okay.

HL Um so you know we needed to back up even further and um knowing that he had the gun and he was going back and forth inside the house, it was one (1) of those decision that I, I didn't really feel comfortable at that point to move the truck but Berry said that he would do it so he ran up and moved the truck back even further.

RS Where were you and [REDACTED] then?

HL [REDACTED] and I were at the back of the truck.

RS So as he backs it up you guys,

HL So he's backing up, we're, I'm covering um from the side, from the passenger side of the vehicle with my pistol and [REDACTED] was behind me and we were, he was walking backwards.

RS Okay.

HL We were walking backward until we got into a place that was safer.

RS Okay. And um what happens after that?

HL He came out of the vehicle, or sorry out of the house several other times he'd go from the window to the house and point the gun, he had,

RS The same window?

HL The same window,

RS Okay.

HL And he'd come from the window to the door, window to the door and repetitively like within you know five (5) minutes of each other, he'd be at the window and then he'd be at the door and once I can remember one (1) time that he came outside of the house and did like a little dance and was hollow ring and screaming and saying come, come get me, come get me, oh before that sorry I keep reverting back.

RS No that's fine, that's fine.

HL Um he had told us leave your car it's mine, leave your car it's mine and that was before Berry had backed the car up to the location that it is now.

RS Okay.

HL And then um,

RS So where it's at now, eventually when we get down there that is where you guys left it?

HL I believe we didn't back it up any further than that but we might have backed it up one (1) more time.

RS Okay when he's coming out these other times, was he pointing the rifle at,

HL He was pointing the rifle right at us,

RS Okay.

HL Between one (1) and the other of us.

RS Okay. Even on the last part when you didn't, did you guys' kind of move away from the truck at one (1) point your, your patrol unit?

HL No we stayed undercover.

RS No you stayed, okay so you guys stayed behind it the whole time.

HL We stayed, yeah we were behind the car the whole time, except for when the,

RS So mainly he what he was doing was pointing there at the truck?

HL Right, right at the truck and if he could see any part of us he would dart back and forth.

RS Okay. Was he saying anything then?

HL He was yelling all kinds of weird stuff um saying that he was, he'd already killed a bunch of people and you know he was going to keep on doing it and he didn't want to go back to [REDACTED] and he, they, that we weren't going to take him back.

RS Okay.

HL We weren't going to take him back.

RS Okay. So eventually you guys radio for more help?

HL Berry did that upon the initial um before we had backed the vehicle up,

RS Okay, okay.

HL When, when we first saw the, the gun and I notified Berry that I saw a gun and he immediately go on, on the radio and notified dispatch.

RS How long are you guys parked there until you know that backup arrived?

HL Lets see, I know when we talked to um [REDACTED] that that was two forty five (2:45) so I, it was probably about fifteen (15) minutes or so that we were talking to him and I want to say about thirty (30) minutes before any additional, any additional units arrive.

RS Okay, okay. So when the other additional units arrive, what happens then?

HL Oh we had just pretty much watched the door, like we had been doing, watching the door, watching the windows.

RS Okay.

HL Um trying to keep advantage point, um my, my patrol cars not equipped with a rifle or you know any other kind of firepower.

RS Okay you just had the shotgun with you.

HL I just had the shotgun, at that time,

RS When you, you and when you and Deputy Berry traded that back and forth once in a while?

HL Yeah we didn't get the shotgun out until after we were back as we are far as we are now and then we'd crept up,

RS Okay.

HL Um both of our batteries were dying on our radio's, um I've got a car charger for it unfortunately it didn't work.

RS Oh,

HL So you know we were losing radio contact so the only way we could contact anybody is if we actually went up to the car, we left one (1) of the, we left the drivers side door open so we could have a little bit more concealment as we went in to use the radio and I grabbed my cell phone, and then I ended up grabbing my other cell phone. I have a work phone and a personal phone, I grabbed both of those and we pretty much sat down at the back and got um additional rounds for my shotgun in the back of the car, we got some more of those out just in case, we knew we were out gunned once he really, oh he came out and was dry firing the gun at one (1) point.

RS The rifle still the same one (1)?

HL The rifle,

RS Did you ever see any other weapons besides that one (1)?

HL Just the,

RS The toy, the pistol?

HL Pistol that was either a toy or not a toy I don't know at that point I didn't care,

RS Okay.

HL The knives um,

RS Um did you ever hear any gunshots?

HL Oh yeah.

RS When did that happen?

HL Um I couldn't tell you the exact time that they happened.

RS About the time when the other units arrived?

HL It was about I want to say eight thirty (8:30) or so,

RS Okay.

HL Right around there I, I guess that would be the second one.

RS How.

HL Um the first one (1) was shortly thereafter the other units did arrive, it wasn't, it wasn't to long.

RS Okay.

HL And then

RS How many, how many shots did you hear?

HL I heard three (3).

RS Okay. Could you see any shots being fired or exchanged or anything?

HL No I couldn't.

RS Okay. And then about eight thirty (8:30) it happens again?

HL Mm hmm.

RS Did you see anything then?

HL No I didn't. At that time the SET Team had just gotten to us.

RS Okay.

HL Um so they told us that you know we could take the back road out either the way that they went or possibly find another route and as we were leaving the shot fired again, so we ran back to the vehicle.

RS How many shots did you hear that time?

HL I hear three (3).

RS Okay.

HL It sound like firecrackers.

RS Okay, and eventually you guys are relieved by the SWAT Team?

HL Yes.

RS And, and brought back?

HL We walked, we walked out ourselves, the SET Team stayed there.

RS Okay they stayed and you guys walked out.

HL They all stayed there.

RS And did how, which way did you guys go?

HL The SET Team came in from, if that's east,

RS That would be south.

HL The SET Team came in from the south.

RS Okay.

HL I could hear them coming and they had told us that they were coming prior to them actually showing up. We went walked up to the house, talked to the um the man that lives there, who is [REDACTED] dad.

RS Okay.

HL [REDACTED] had left and went up to his dad's house and said he was cold, he's sick and he's gonna go get some blankets, wasn't sure if he was gonna return or not but that's where he said he was gonna go. We'd also asked him to go up there and warn his, his dad to stay in the house and not come out, prior to that, while we were waiting.

RS Okay.

HL Sorry. So we walked up to his house and asked him the easiest way out to the main road and he told us it would be um,

RS Just to come back up out and around?

HL Just to come back up towards the cross and then back down.

RS Okay. What unit number were you driving Heather?

HL Thirty five (35). It's brand new I just got it four (4) days ago.

RS That's what Berry was telling me. When he's pointing the uh gun at you guys what was going through your mind?

HL ...Holy shit.

RS Yeah.

HL Yeah um this is the first incident like this I've, I've had to deal with uh,

RS Did you think he was gonna try to kill you guys?

HL Oh yes definitely.

RS Why didn't you guys shoot?

HI Knowing that [REDACTED] and at the, when we were close enough to use our pistols it didn't appear that he had any rounds in his gun, knowing from what [REDACTED] had said,

RS From this clicking noise that I keep hearing about?

HL Yes, yeah, the click, click, click, click,

RS Yeah.

HL Click, click, click, click. I'm, I'm assuming that he, he's dry firing it um,

RS Okay.

HL But he didn't have enough time to apparent, I didn't feel that he had enough time to search the whole house for these rifle rounds, when we actually had a shot and possibly when he was searching for those rounds was our opportunity to back out because,

RS So in your mind, because of what [REDACTED] tells you, he's holding a gun that's not loaded?

HL Right.

RS Okay. Obviously things changed later on.

HL Things, things changed definitely but um he had also told us that there was no way that he could get into any ammunition, that the, everything was in a safe that he would only have a certain amount of rounds that, twenty two (22) rounds that were inside of uh, uh drawer that wasn't located right next to the gun, they were in a totally separate area so and that the gun wasn't loaded that uh twenty two (22) was not loaded. With the time limit that he had from the, from what [REDACTED] was telling us, the time limit that he had from um getting the gun to going to the front door didn't have enough time to find those rifle rounds and so we took the opportunity to back up and get farther away rather than try to take a shot at him.

RS Okay.

HL And wait for backup, was we figured would be our best, our best option.

RS Okay. Okay and your patrol unit is a marked unit?

HL It is a marked unit.

RS Were you in full uniform like you're sitting here now with me, so there's no idea, there's no doubt that he knew you were law enforcement?

HL No doubt in his mind no, there shouldn't have been.

RS Okay. Heather is there anything that I haven't asked you that would be important for me to know about what happened, that you can think of?

HL I can't think of anything right now, I'll probably later.

RS Okay.

HL But,

RS That's fine, you know how to get a hold of me. I can't think of nothing either. We'll end the interview at twenty three forty nine (2349) hours.

End of transcript.

Transcribed on 1/8/2008 by [REDACTED] 0608.

HUMBOLDT COUNTY SHERIFF'S DEPARTMENT

CASE: 200703162
INTERVIEWER: Rich Schlesiger, Detective
SUBJECT: Attempt PC 187/ Officer Involved Shooting
STATEMENT OF: Jason S. Daniels, Deputy Sheriff
DATE & TIME: June 4th, 2007 @ 0322 hours.
LOCATION: Hoopa, California

ALSO PRESENT:

RS Rich Schlesiger
JD Jason Daniels

RS Okay date is June fourth (4th) two thousand and seven (2007), time is zero three twenty two (0322). Jason what's your middle initial?

JD "S".

RS Daniels.

JD Yes, D-A-N-I-E-L-S.

RS Pin?

JD Eleven ninety one (1191).

RS And how long have you been a Deputy Sheriff with us?

JD Uh seven and a half (7 ½) years.

RS And you're also, I don't know what the proper term is for the SWAT Team?

JD Uh, I don't know I'm a Hostage Negotiator and we're attached to the, to the SWAT Team.

RS Okay. How long have you been doing that?

JD Uh less than a year.

RS Okay. Um we're talking out in my vehicle up on Bloody Camp Road, um and how did you end up getting called out here regarding um the [REDACTED] shooting at the deputies?

JD Uh, I got called at home by Dispatch uh requesting a call out for negotiations.

RS What time was that?

JD At uh sixteen hundred (1600).

RS Okay and you, you were working graveyards tonight?

JD correct.

RS So that's eight (8) to six (6) in the morning?

JD Correct.

RS Okay um what time did you get called, six (6)?

JD Uh sixteen hundred (1600) four (4) o'clock.

RS Sixteen hundred (1600) and what time did you eventually make it up here?

JD Uh I got here at about eighteen twenty five (1825).

RS Okay uh was the S.E.T. Team up here by then?

JD Uh yes.

RS Okay.

JD They, they were getting here. We arrived about the same time as uh most of the S.E.T. guys.

RS Okay. Um and did you have another negotiator with you today?

JD I did, uh Sergeant Fridley.

RS Okay and who directed you to uh begin negotiations?

JD Uh Lieutenant Cavinta.

RS Okay was that shortly after you arrived?

JD Yeah and um that was paralleled with Sergeant Quenell.

RS Okay.

JD We just uh, we told them when, when we were ready and told them when they were ready let us know, we could start.

RS Did you know what the situation was and all that?

JD We were briefed yes.

RS Okay and um I can't remember his first name,

JD [REDACTED]

RS [REDACTED] [REDACTED]. Um how did you guys begin attempting negotiations?

JD Uh well the, the first thing that happened when we were here, before we even got down the road, we heard a couple of shots, uh being fired.

RS Where were you at, at that time?

JD We were right at the intersection of the paved road uh going on to the graveled road.

RS Okay so the gravel road leads to the residence?

JD Correct. Uh Sergeant Fridley and I uh both got into his patrol vehicle and started down the road uh with everybody else as we were going towards the gunshots.

RS How many shots did you hear Jason?

JD I think I heard two (2) smaller shots and one (1) bigger shot.

RS Okay and um where did you guys take up position down there?

JD Uh all the cars were parked one (1) in front of another and uh we just got out and took position behind them.

RS There was quite a few?

JD Several, there were like a dozen cars down there or something.

RS I walked done there at one (1) point and, and you and Sergeant Fridley were in an Expedition was it?

JD Uh yeah, Tribal.

RS A Tribal Expedition.

JD Yeah.

RS Okay and um after the shots were fired, what happened then?

JD Uh we got ourselves uh settled down and uh we got ourselves prepared to start attempting to negotiate.

RS Okay and how was that going to happen?

JD Um what we, the information we got and we determined that there was no phones inside and we were gonna be able to get a throw phone to them due to the access and with him being an active shooter so the only thing we had was the loud speaker on a patrol vehicle, the tribal patrol vehicle.

RS Okay. And do you know what time, I mean I'm guessing you guys utilized the loud speaker?

JD That is correct.

RS What, what time would that have been?

JD Uh we started at approximately nineteen zero three (1903) hours.

RS Okay and what happened with those negotiations?

JD Um we started out with Sergeant Fridley as the primary, myself as the secondary or the coach and uh our game plan was the,

RS Can, can you explain that to me real quick?

JD Uh Sergeant Fridley was on the um on, on the loud speaker and I was coaching him, helping him with phrases and what to say.

RS Okay.

JD And keeping him calm, keeping him moving along.

RS Okay.

JD It's standard operating procedure at for first and secondary.

RS Okay.

JD Um he just took up the position as the primary, we didn't really have one thing set one way or another, um our game plan was we, weren't really going to be able to negotiate because we couldn't talk to him, um so we went into what we call the surrender phrase, which is basically um giving him uh direct orders with encouragement to uh come out side peacefully, uh stop the shooting, resolve the situation.

RS What were, can you give me some examples?

JD Yeah. Um we just made statements uh we, we would refer to him like you know, " [REDACTED] this is Jason with the Sheriff's Office and you know we're, we're here to help you and we want to resolve the situation, we don't want anybody to get hurt, uh we want you to put the weapons down, come outside with your hands up, talk to the officer who are outside, they'll direct you what to do." Uh we gave some more statements over and over and over um but he, we weren't able to get any real response from him um we would hear some screaming from him, so yelling.

RS Anything that you could understand?

JD No and the only thing, we, we heard something uh that was kind of real definite like he, you could hear he was saying something but we couldn't make out what he said but the SWAT guys in front of us said that he stated uh something like "come get some mother fucker" or "mother fucker come get some", it was I'm not sure.

RS And that was relayed to you from the SWAT guys?

JD Directly back uh cause they're only you know uh oh twelve (12) fifteen (15) in front of us.

RS Okay.

JD So we, we did this uh when, when he was active they uh, the SWAT Team could see him you know moving around inside; we did this with a short break in between each statement we would give.

RS How, how long would you wait?

JD Like um oh ten (10) fifteen (15) seconds, long enough for him to make a response if he didn't respond with anything we would just give out another one and another one and another

one uh giving him a break in between each one (1) um so he would uh have the opportunity to yell back at us and we could try to communicate with him. That went on for quite a while and I'm guessing like maybe, maybe an hour or so I, I'm not sure.

RS And is that you and Fridley together?

JD Correct and, and we actually would switch back and forth at times um where I would take over talking and he would coach and we would kind of flip flop back and forth. Um there are tapes, and we're still actively recording down there.

RS You are recording?

JD Yeah. Uh there, there's tapes and we try to note the time each time we would stop the tape, um if there was a five (5) or ten (10) minute break because it got to the point where there was no movement, we'd give a five (5) ten (10) sometimes even like a thirty (30) minute break there um where we wouldn't say anything it just uh wait and then we would get back on the loud speaker and try it again, we would turn the tape back on um, try to give our name and the time real fast um and then we had another shot fired off from him at some point in there and I don't know the time.

RS Around nine (9)?

JD Yeah we're pretty sure, I think that was about it, we're pretty sure that um that was actually on tape, at least some of the firing, we think, uh Fridley was,

RS How many rounds did you hear Jason?

JD There was one (1) distinctive round coming at us and um six (6) to eight (8) rounds going out from us.

RS Okay.

JD Um the one (1) round, was smaller, I'm guessing a twenty two (22) that made kind of a zing noise um Fridley and I are very confident that we heard it probably hit the first tribal vehicle, sound like it hit the roof and we definitely heard it go through the vegetation right near us.

RS Okay.

JD We could actually hear it shredding through there.

RS How far Jason were you from first tribal vehicle?

JD Oh, ten (10) feet.

RS Okay. How far were you guys away from the house?

JD Um I'm guessing maybe about fifty (50) yards or so, I'm (inaudible)

RS (Inaudible) with a loud speaker someone could hear it?

JD Yes,

RS Okay.

JD Yes cause we could hear him yelling so on the loud speaker he should have been able to hear us no problem.

RS So from, from what I gather from the negotiations he, he could hear you. There were numerous attempts for at least an hour?

JD Oh yeah probably longer,

RS And never actually a direct response to you guys at all?

JD Not that I know.

RS Okay. And you guys just came up from there now and obviously it's dark now,

JD Right.

RS When, when did you guys about uh cease the uh, uh negotiations?

JD It was uh right basically when it was dark, we talked to Cavinta and Quenell and told them uh whatever they want, uh that works best for uh the SWAT guys, um what we came up with, it's dark and we start giving him direct orders to come out and he complies the SWAT guys may not be able to see um we don't want anything, anything to go, to go wrong so we decided that we would be available and if need be we could get back on there if he all of a sudden uh surfaced and wanted to talk to somebody we would be available but at this point we were not going to be given any direct orders for him to be coming out um cause the SWAT guys would want to use uh daylight to their advantage.

RS Okay and now uh what has happened is uh Eureka Police Department Negotiators have taken over for you?

JD Correct.

RS And you've briefed them on the situation on everything?

JD Yes.

RS Okay. Jason is there anything I haven't asked you about the incident today that uh I forgot to ask you, that you can think of?

JD Uh, uh I can't think of anything right off hand.

RS Okay we'll end the interview at zero thirty three (033), three thirty three (333) hours.

End of transcript.

Transcribed by [REDACTED] 0608 ON 1/17/08.

HUMBOLDT COUNTY SHERIFF'S OFFICE

CASE: 200703162
INTERVIEWER: Steve Quenell, Detective
SUBJECT: Attempt PC 187/ Investigation.
STATEMENT OF: Jesse Taylor
DATE & TIME: June 7, 2007 14:15 hours.
LOCATION: C.I.D. Eureka, California
ALSO PRESENT: Mike Hislop, DA Chief Investigator.

SQ Steven Quenell
MH Mike Hislop
JT Jesse Taylor

SQ Okay the date is the seventh (7th) of June, it's approximately fourteen fifteen (1415) hours. The case number is two zero, zero, seven, zero three one six two (200703162), uh location is the uh Humboldt County Office Detectives uh area, uh the exact location, the interview will be conducted inside my office, I'm Detective Steve Quenell with the Humboldt County Sheriff's Office, also present is Chief Investigator Mike Hislop with the Humboldt County District Attorney's office and we will be interview Jesse Taylor, his middle name is Allen, his date of birth is zero six, two one, seventy eight (062178) and he's currently working for the Humboldt County Sheriff's Office uh Jesse could you tell me what your current rank is with the Sheriff's Office?

JT I'm a Deputy Sheriff with the Sheriff's Office.

SQ And how long have you been employed by the Humboldt County Sheriff's Office?

JT A little over five (5) years.

SQ Are you currently a member with the S.E.T. Team?

JT Yes I am.

SQ And how long have you been a S.E.T. Team member?

JT Um I believe it's a little over three (3) years.

SQ What's your position with the S.E.T. Team?

JT I'm just uh a operator.

SQ Okay. Have you received any specialized training?

JT I have.

SQ And what type of training have you received?

JT I attended uh basic S.W.A.T. School put on by the F.B.I. and uh I believe it was two thousand three (2003). Um it was a forty (40) hour course, uh conducted in Crescent City, California.

SQ And you completed that course?

JT Yes I did.

SQ Jesse what I'd like for you to do uh we'll be discussing the, the incident that, that happened up off of Bloody Camp road up in the Hoopa area between June third (3) and June fourth (4th), evidently you were there and what'd we'd like to uh hear from you is obviously how you got involved and once you got there what your roll was and what you, you had observed.

JT Okay. Um some time after four (4) o'clock on the third (3rd) I got a call from uh Sergeant Bryan Quenell um he'd inquired with me if I'd uh received the um page, I told him I had not, and then at that point he let me know that we had a S.E.T. call out and I proceeded to gear, gear up and um well gather my gear and gather my gear and uh picked up Sergeant Quenell and drove to the Sheriff's Office. Um most of the team was there uh at the Sheriff's office Briefing room, we proceeded to do a little bit of a briefing on the situation that occurred um and uh at that point I started gathering additional gear and uh Sergeant Quenell and I had doubled up in a patrol car and responded out to the scene.

SQ What was said at the briefing?

JT Um basically that there was a uh, uh, uh a barricaded [REDACTED] in a house uh he made threats towards law enforcement uh he'd banished a weapon at Deputy Berry I believe um and that uh he wasn't coming out of the residence and he'd basically barricaded himself in the there.

SQ Okay. So then it's, you're with Sergeant Quenell and are there any other team members, you guys have loaded up and now you're on your way up to Hoopa?

SQ Do you recall approximately what time it was when everyone arrived at the scene in Hoopa?

JT Uh you know I, it was late afternoon I don't know what time it was, I would say um geez uh five (5) after five (5) sometime, six (6) somewhere in there.

SQ Okay and once you arrived there what took place?

JT Um when we arrived I had uh got out of my patrol car, not even a few minutes after being on scene um I'd hear gun shot um where we had parked was down the road, towards to the east, um out of sight of the residence, um but I would say within a few minutes of arriving on scene we heard gun shots, at that point it was a big scurry to get dressed down um I was only wearing my uh S.E.T. uniform, I hadn't had any gear on or I hadn't armed myself um so at that point I proceeded to go to the back of my patrol car, start dressing down, putting on my tactical gear and retrieving my firearms.

SQ And what firearms were you carrying?

JT Um I was carrying my department issue clock forty (40) handgun, and my department issued two, two three (223) rifle.

SQ Okay. And at that point did you guys break up into teams or did you do that sometime later?

JT Uh at that point it was just kind of a uh rush to get to um where the Hoopa Tribal uh patrol cars were, um to assist in any way that we could and, and responding to those gun shots that we heard. Uh after doing that um the, the team was eventually divided up into different teams um my assignment basically during the whole entire incident was at those patrol cars um on what we uh, uh dictated as the number four (4) sided of the residence.

SQ And by patrol cars?

JT Yeah the Hoopa Tribal Patrol cars were two (2) Ford Explorers that were parked um uh fairly close to the [REDACTED] residence.

SQ Did those patrol units have any markings on them?

JT Yes they did.

SQ What kind of markings did they have on them?

JT Um the Hoopa Tribal Valley uh insignia or, or uh graphics on the side of the car, I believe they both had uh light bars on the top um some sort of lights in the front and uh was well distinguished that they were law enforcement cars.

SQ Okay. Were there any other law enforcement vehicles in that area?

JT Um not that I could see from my vantage point that was pretty much it, up the road where we had parked um our patrol cars to the, to the east, there was quite a few uh patrol cars um trucks, the S.E.T. Trailer was there, it was a convoy pretty much parked along the entire length of the road.

SQ Okay. So when you arrived by these patrol units, Hoopa Valley's patrol units, was the whole S.E.T. Team there at that point?

JT Um pretty much as far as I remember um I think there were a couple, couple of members who were uh delayed, uh I know Sergeant Garcia and Deputy Massaro were a little bit delayed, uh I don't think they were there um right away upon my arrival, but other than that uh for the most part, the entire, the rest of the team was there.

SQ Okay, and then what happened?

JT Uh I went to the uh, there was two (2) Hoopa Tribal uh cars, I went to uh the second (2nd) one initially, there was uh a uh, uh cluster of members at the first (1st) uh Hoopa Tribal car um and basically I was um waiting to rotate to that number one (1) car um and at some point uh I would say in a few minutes that's where I took a position was behind the first (1st) uh Hoopa Tribal car um to assist in covering the [REDACTED] residence.

SQ Okay.

JT Um when doing so I noticed that both patrol cars had been struck by what appeared to be bullets um, the second (2nd) car had one (1) bullet to the windshield, if I recall correctly and then the first patrol car had two (2) bullets that had uh, hit the uh front windshield um what I assumed were bullets, they, they appeared consistent with that.

SQ So that damage to the patrol units that you're describing uh occurred prior to you getting there?

JT Yeah and I, I believe that uh as I heard those rounds when we first arrived on scene, those, that was the result of those uh, those gun shots was those bullets hitting the patrol cars. Seeing that obviously um put us at a uh, uh you know a obvious heightened level of threat, uh see that uh bullets were definitely uh you know very close to where we were.

SQ Okay.

JT Um prior to me going to the first (1st) patrol car, Brian Taylor was um was at the first patrol car. I had heard through other members that he had returned fire, um and that was basically all the information that I'd really gathered. We had been fired at and a member had

fired uh in return, um I didn't see that um but I was told that later. Um after that it was just uh it was waiting it out, I, I pretty much stacked on that number one (1) car for a long time um I don't know exactly time wise, but um probably maybe forty five (45) minutes to an hour um with other members and uh um sometime after I would say half an hour, forty five (45) minutes, maybe an hour, I uh left the number one (1) car to um retrieve uh keys for um uh a dispatcher to start moving cars was what, what the plan was, all the convoy of cars that were parked on the road um, she was trying to get keys to, to move those cars out. Uh at that point I'd given the dispatcher uh [REDACTED] my patrol car keys um, grabbed a bottle of water and was going back to the uh the uh first (1st) Hoopa Tribal car, at that point I'd heard that uh via radio traffic that the number four (4) "A" window, which we distinguished as four A (4A) um which is on the south side of the residence was starting to open, um I took a position of cover behind the, the uh Hoopa Tribal patrol car um could hear via radio traffic that uh a barrel was see um and shortly after that uh I believe at least one (1) round was fired from the [REDACTED] residence. Um reacting to that, um took a cover position behind the patrol car uh there was about three (3) or four (4) member on the drivers side of the patrol car um so I really didn't have a position to try and get up on target to the [REDACTED] house um, at that point some members had fired uh their patrol rifles um after being fired upon. Uh seeing that I didn't have a position on the drivers side of the patrol car, I, I ran over to the passengers side where Deputy Gomes was and just about the time I made it um to the passengers side Deputy Gomes had fired uh his patrol rifle and at that point I came up on target and the firing had ceased and I could see a threat in the window or at the house and um it was pretty much almost silence um after that.

SQ Approximately how far away were you guys that were around patrol units and where the guy was shooting out of where the barrel was seen that obviously that?

JT We ranged it, I don't remember what the exact yardage was um I think originally we'd estimated uh sixty five (65) yards, something like that.

SQ Okay. You had mentioned uh that you'd gave the keys to [REDACTED]?

JT That's correct.

Sq She was up there too?

JT Yeah um tactical dispatchers were um, I'm assuming paged or responded um herself and [REDACTED] had responded um and I guess it was designated as one (1) of her duties to try and retrieve uh keys to the cars so they could start backing them out of the, out of the driveway.

SQ Okay, okay. Alright so you're at the patrol units uh, this was the last shot that he fired from inside the house, then what happened, took place?

JT At that point I pretty much posted, I relieved Deputy Gomes of his post, which was at the passengers side of the first Hoopa Tribal car and I pretty much posted there um what seemed like hours in to the night basically I did not leave that position um and was eventually rotated out but

that was pretty much um what my assignment was and where I'd uh taken my position at on the passenger side. Um as the sun started to set we started um preparing for darkness, I was uh supplied with a set of night vision goggles um, at some point I was rotated out that position but for the most part um I was fairly uh fresh and had a lot, you know a lot of energy and adrenaline going so I posted up at the position for I would estimate hours um as the sunset I equipped myself with night vision goggles um basically maintaining consistent uh, uh visual contact with [REDACTED] house threw those goggles and into the night. Uh at some point during the night I was told by I believe Sergeant Quenell that the Eureka Police Department S.W.A.T. Team had been contacted and they would be relieving us um I think it was originally planned for about zero three (0300) hours um they would be relieving us we would go into Willow Creek and rest up and respond back to the scene uh the following day at uh sunrise.

SQ During that time period that you just discussed, did you see anything inside the residence, any movement, or did you hear anything inside the residence?

JT Yeah um there was pretty much um I wouldn't say constant but frequent um attempts to communicate with the [REDACTED] inside via a Public Address System, um both, (cell phone ringing) both uh Sergeant Fridley and, and Jason Daniel who are our negotiators had used that Public Address System on the number two (2) patrol car, um trying to make contact with anyone inside, um during some of that I do recall hearing yelling um at one (1) point I could hear a very distinctive um, um something similar to "mother fucker's bring it on" or bring, bring it or something to that effect um so you could, you could definitely hear some sort of dialogue, other than those words, I don't really recall any um exact or I don't think I could hear and exact vocabulary coming from the house.

SQ What about the uh negotiators, Sergeant Fridley and Deputy Daniels, do you recall anything that they had said during their negotiation?

JT Yeah it was um, a lot of it was re, just you know just repeated request to uh come out of the house, to, to disarm yourself come out of the house, um you'll be, you know given instruction what to do once you come out of the front door, it was uh very clear he was to come out of the front door, uh unarmed uh, um, um basically trying to uh talk him out of the, out of the situation um and I (inaudible) some sort of compliance or response um just so we could have some sort of communication with him.

SQ Okay. How far away from the negotiators were you?

JT Um well I was at the, the first (1st) Hoopa Tribal car and the negotiators were at the second (2nd) Hoopa Tribal car, I think there was maybe ten (10) yards, fifteen (15) yards separating the two (2) so I mean it was pretty, it was pretty close.

SQ Okay.

JT Um definitely loud, I mean it, it at times you know from my advantage point it was, it was you know kind of in my ear and definitely loud. You could hear the requests at some time, at, at some point's kind of echoing off the mountains or through the canyon um uh with that P.A. system.

SQ Okay.

JT Um I don't recall exactly when but at some point the, the, there was no response from the residence, it pretty much went quite um there was no, no um yelling or anything of the effect.

SQ Any lights on?

JT As it got dark, lights started to um come on and then, and the four (4) side of the residence and the "B" window, we could see, we could see a flickering light for uh just about the entire night. Uh we concluded or speculated that it was probably a television flickering um and then later on in the night the number four (4) A window uh would have some flashes um kind of like a flickering light thought maybe it was uh, maybe a house uh like a woodstove fire or maybe somebody trying to smoke something, it was that kind of flicker, it wasn't a steady solid light and then that kind of went away um at some point during the early morning hours, it looked like what appeared to be like a flood light or exterior came on um and looking through my night vision goggles, it got really bright so I'm that's why I'm assuming it was an outside light, that light kind of went out, um but for the most part through the night, lights kind of were on and off um or flickering uh for most of the night.

SQ And then at some point you guys were relieved?

JT Yeah I think it uh some time after about zero three (0300) hours that morning, um Eureka Police Department arrived on scene um they'd been, I'm assuming briefed of what was uh there assignments were, um and at that point some officers came up to where I was and then I rotated out with an officer at that point.

SQ Okay.

JT Um the Sheriff's Office team rallied back at the uh, uh the Command Van and uh we were given instructions to um uh dress out of our gear and to meet at the Hoopa uh Substation. From there we um ate, rested up as best we could, um talked uh strategies and what we, what our assignments would be for the next day, um I didn't sleep at that point I um but I did eat and rest and uh um sometime during that morning we briefed about what the next step was and what the, the, what our plans were going to be.

SQ During this incident, who was your supervisor or your team leader?

JT Sergeant Quenell.

SQ Were there any other team leaders involved?

JT There were uh Sergeant Garcia um and Sergeant Miller, I'm not sure if he was taking a team leader role but he was um he's typically assigned to the snipers on the team.

SQ Okay and its your understanding who was the over all uh supervisor in charge of the S.E.T. Team?

JT Uh on the scene overall it would be Lieutenant uh Cavinta.

SQ Okay.

JT Um that morning some time around zero five hundred (0500) zero six hundred (0600) uh we briefed uh the team was split into various teams, my team um leader was Sergeant Quenell, um and basically our assignment was to go right back where I was uh at that, that first Hoopa Tribal car, um and, and relieved Eureka Police Department of their, their, post. Um we had discussed during our briefing uh various um gas plans as far as what we were gonna do, um uh for the day and um basically once we arrived on scene we, we kind of waited for the next set of orders to, to come out. Um I posted up at the same spot that I was uh the night before, um I think I bounced from the passenger side to the driver's side of that first Hoopa uh Hoopa Tribal patrol car, um but uh basically waited it out, didn't hear anything, didn't see anything um from the [REDACTED] house. Um that morning, I think it was right around um I don't know if I'm bouncing ahead to far, eleven fifteen (11:15) or so um gas was introduced to the house uh, the, uh prior to that the California Department of Corrections um were, were on scene, they attempted negotiations through a P.A. system, um no response and uh sometime around eleven fifteen (1115) gas was deployed into the house. Um after numerous rounds were fired into the house um there was no response, the [REDACTED] didn't come out of the house um and, and there was (Hanson to the Under Sheriff's office, please Hanson) quite a few volleys of uh, of um different areas of the house that was hit, um I did not deploy any gas personally, my job was to cover at the, at the number one (1) patrol car um during the entire time. Um part of my team was uh Deputy Barney and Deputy Bryan Taylor and they were the two (2) um team members who were launching gas into the house. Um.

SQ Do you know what type of gas they were launching?

JT Uh they launched both C.S. and C.N. I believe I, they were discussing it um, um there was gas launched from a thirty seven (37) millimeter um launcher and a twelve (12) gauge ferrite rounds were also shot into the house, um,

SQ Do you know, excuse me, do you know who gave the order to deploy gas?

JT Uh Lieutenant Cavinta had given the order.

SQ How do you know that?

JT I heard it via my, my radio, Sergeant Quenell had uh initially told Lieutenant Cavinta that the team was in position ready to introduce gas and at that point Lieutenant Cavinta gave the go ahead to, to go ahead and start doing that.

SQ Okay.

JT Um after gas was introduced we pretty much came to a, a stand still there was no response, um we, we really you know couldn't tell if it was effective or if it was um basically working, there was uh you know typically in a house that size um you would get some sort of a response and uh it was basically silent after the gas was, was, was done, there was no, no activity at all.

SQ Was negotiations continuing on?

JT During that entire time negotiations were, were just repeated through out the entire incident.

SQ And, and who was doing the negotiating?

JT Um at that time it was Sergeant uh Fridley, prior to the gas being introduced uh the C.D.C. negotiators were negotiating on the P.A. system.

SQ And were they continuing to use the same dialogue that they started out with?

JT Pretty much yeah, it was, it was a lot of it was just repeated you know hey come out you know, you know we can work this out um, trying to minimize the, the situation you know this isn't a big deal uh we can work on this let, you know let us know what we can do to help you, we want, you know we want to end this peacefully that kind of stuff um there was no response what so ever as far as I can recall.

SQ Okay.

JT Um some point during the uh the introduction of gas I know the Eureka Police Department um also assisted in that, um I could hear that through my radio um I believe they took a position on the number three (3) side and started launching gas into the house um and again there was no response um, uh, uh a couple times um both teams were, were firing gas into the house uh not at the same time but one (1) team would fire, fire gas and then the next team would fire gas on a different side of the house um attempting to maybe flush, flush the [REDACTED] to a certain area of the house, or just get as much gas in there um to be, you know to be effective. Um during that uh some windows, um some of the gas was going in some of it wasn't um some windows were broken out with the twelve gauge ferret rounds um but for the most part I think um I don't want to guess, I wasn't doing the, the shooting, the launching of the gas but for the most part it was starting to, to enter at a pretty successful rate. Um after, after that there was still

no response um at some point we came up with a plan to introduce gas in the form of a canister, um which it's my, which is my understand it's a little bit more effective, more concentrated, um I, I really don't know I'm not a gas person, um but uh we came up with a, a um a plan to introduce gas into the number four (4) side of the residence via a canister which has to be thrown by hand kind of um, kind of like a, a grenade, for lack of a better term but um the Department of Corrections, uh had a team, tactical team respond to the number one (1) car, they relieved us, relieved us of our duties, they also provided us with a tactical blanket um, which is basically a bullet resistant uh blanket um. Myself, sergeant Quenell, Deputy Massaro, Deputy Barney and Deputy Brian Taylor um were part of this team to introduce this canister um behind the tactical blanket um uh we uh, Deputy Barney had the gas, the canisters, um and we approached the house from the number four (4) side very susceptible to any kind of a threat because the only cover we had was that tactical blanket um and there was no, it was pretty wide open there was no trees or um you know real good cover to use so um it was, it was pretty intense to get from the patrol cars to the [REDACTED] house um get the canisters in and then retreat back the same way, that's what we did end up doing, um approaching the house from the, from the driveway um once we got in front of the house we made a pretty much a straight line to the house uh introduced gas into the number four (4) A and four (4) "B" windows um uh and retreat back to the patrol cars.

SQ Who introduced the gas?

JT Um Deputy Barney introduced the gas uh as far as I recall um pretty much Deputy Massaro, Deputy Brian Taylor um were carrying that blanket on, that was on a pole um and, and uh I think Deputy Barney also assisted in carrying it but once we got to the house, myself and Sergeant Quenell covered the house while the house, while Deputy Barney um threw the canisters of gas inside the, the residence.

SQ Was he successful in getting the canisters inside the house?

JT He was initially yes, um during that uh that series um I think he got three (3) canisters in, I could be wrong, it might be two (2), I, but in both in the four (4) A, and four (4) B windows there was at least one (1) canister of gas introduced. Um once we did that we retreated back to the patrol cars, relieved the C.D.C. of there uh assignment again, posted up at that first (1st) patrol car, waited to see what the effects were, uh if any, were gonna be, um we could see that uh white gas was kind of um coming up in those two (2) rooms um but after waiting a while um again there was no response uh with that gas. Um some time after that uh Lieutenant Cavinta had asked Sergeant Quenell on the radio um uh if we could do another series of that uh basically the same plan, repeating what I, I just described uh we decided that we could do that um one (1) of the uh C.D.C. guys, I don't remember his name uh came down with his team, he had gas with him at that point, um it was like a jacket with several canisters of gas um in that jacket. Basically described um each canister um to us, more directly towards Deputy Barney who was going to be um introducing the gas and Sergeant Quenell, I was just there observing that um, there were several canisters that he had uh brought down from the cars um I do recall specifically that um uh for the most part the gas that he was explaining to us was um contained smoke so it would be more effective in filtering through the house, uh he did bring pyrotechnic gas with him and I do

recall specifically that gas being removed from that jacket and uh left at the patrol car um and we did not bring any pyrotechnic gas as far as we know, I didn't watch each canister specially go in that jacket, it wasn't my responsibility but I do remember that conversation. We basically repeated the same approach behind the tactical blanket in the same team um we deployed gas given to us by C.D.C. through the four (4) "A" and the four (4) "B" windows um at one (1) point um a canister didn't make it into the four (4) "B" window, Deputy Barney had thrown it, it hit like a cross beam, bounced back out um Sergeant Quenell went uh in front of the tactical blanket, picked up the canister and threw it back in the, in the room, and at that point we as a team retreated back to our patrol cars, behind the, the tactical blanket. Um after that was introduced we kind of caught our breath, we didn't uh, um take over our assignment at the number one (1) patrol car um C.D.C. basically stayed there in place um kind of just watching covering the house, um from my vantage point it seemed like a lot of gas was being filtered to the house, it seemed to be effective, you could see um what, what looked like a lot higher volume of gas starting to filter through the house um you could see it kind of coming out the windows and maybe threw the roof. I mean it was definitely uh pretty concentrated and, and uh we just sat back at that patrol car and waited to see if we were going to get a response. Um there was no response from the house, uh there was continued negotiations through the P.A. system uh by Sergeant Fridley, um and after uh a while um the what looked like white gas was now starting to turn dark, uh and assuming that uh you know it was smoke caused by fire,

SQ Mm hmm.

JT Um uh that lasted for awhile and then uh eventually the house, you could start seeing flames and the eventually the house uh had, had become engulfed in fire.

SQ Where you hearing any noise come from, from the house?

JT I could hear, once the fire started I could hear a lot of noise um it kind of sounded like things falling maybe um at some point there was a lot of um popping, what sounded like rounds either being shot or either being burnt by the fire. I specifically remember hearing a muffled um (inaudible) what sounded like a gunshot um being fired. It was really only speculation I didn't know you know, it's kind of what it reminded me of was a muffled gun shot um and then right after that I could hear, what sounded like something hitting the floor or you know basically stuff was starting to cave in on it self in the house, um but during the fire you could hear quite a bit of uh of uh what sounded like gunshots or rounds being burnt.

SQ Mm hmm.

JT By the fire. Um didn't hear any vocabulary or, or any yelling or screaming at all what so ever from the house. Um the fire pretty much consumed the house um from, from my vantage point uh entirely um uh the fire department or the volunteer fire department had responded uh we moved the um the road way free and clear so they could come in and um basically watch them kind of douse the house with water and extinguish the fire. I never went to the house after that I

never approached the house um and, and basically you know our assignment was over at that point.

SQ How many fire trucks did you uh or do you recall seeing (inaudible) responded to the scene?

JT At least two (2) I want to say three (3) maybe and then a water truck came eventually after that, I'm not sure exactly. I do remember seeing at least two (2) fire trucks.

SQ And you left the scene, walked up the road with the rest of your team?

JT Yeah we um kind of gathered our gear and proceeded back up to the road and met at the top of the road where the Command van um and waited for instructions um basically our instructions were to not dress down yet at that point um to leave all of our gear on until the um investigators could uh photograph us and inspect, inspect our gear and weapons. Um that was done and after that I dressed down um uh put all my gear in the, the patrol car and myself and Sergeant Garcia doubled up and returned back to main station in Eureka.

SQ You know about what time that was?

JT It all seems like a blur now um sometime in the late afternoon on the second (2nd) day.

SQ Okay. Jesse is there anything that, that we haven't asked you that, that you feel uh that you know that may help shed some light on this incident, other than what we've already talked about?

JT Nay, I, I think that's it pretty much um as far as you know I recall, it, it was a long night so I mean um you know as far as times go and, and um I'm kind of guessing at that but uh as far as the overall um what I just told you is basically my best recollection of what happened.

SQ Mm hmm. Would you consider that individual that was inside the residence a threat?

JT Very much so yes I was um, during the entire time I was very concerned for my safety, my, my fellow team members safety it was a very uncomfortable um feeling knowing that you know that we'd been fired upon at my post on the passenger side of that first patrol car there was two (2) bullet holes less than three (3) feet, what I thought were bullet holes less than three (3) feet from where I was seated, uh, uh positioned, so I mean it was definitely a uh edgy type feeling and at any point um you felt that uh you know a threat could um come from the house during the entire time.

SQ Besides a threat to law enforcement, would you consider him a threat to the community also?

JT Definitely I don't think that um by us not taking action or if we just left that scene I think that um people or him or the [REDACTED] himself would be in definite danger um he had displayed that to us. Um from what I understand he had a history of, of um uh problems and it was definitely a scene that um uh put us all on alert and, and, and you know honestly was kind of a scary situation.

MH Jess think back um at the time of the last smoke canister was introduced, what was the time period between when that smoke canister was introduced and you first saw dark smoke like flames burning inside?

JT Um it was awhile, it, it, you know I could, I could speculate um but I want to say it was over ten (10) minutes um maybe fifteen (15) maybe twenty (20), I don't recall. It wasn't right away I mean it was obvious that the smoke had filtered through the house, the white smoke um and after, once the white smoke started to turn dark um it was, it was quite a while. I would say fifteen (15) minutes um would be a good estimate as far as I could remember.

MH So was the, was the, the black smoke and eventually the first (1st) flames that you noticed, you noticed, where was that in proximity of where the last canister was thrown?

JT Um the four (4) "B" window was where it started to filter out black and then the four (4) "B" window or that three (3) four (4) side of that residence was pretty much where the flames started to come up.

MH Is that where the canister was thrown?

JT Yeah.

MH Okay now, now think back from the first time you saw the black smoke to the time that the whole building was engulfed, how long did that take?

JT Um it was awhile, again uh, uh I'm only guessing but from the black smoke to the fully engulfed house another ten (10) or fifteen (15) minutes, it took a long, it took a long time for it to start turning black and for, for the flames to be seen.

MH So if you were the [REDACTED] in the house, would you had plenty of time to get out of the house when the flames started (inaudible)?

JT Uh yeah I mean there was, there was, plus there was being instructions going over the P.A. system to get out of the house, that we thought that it was now on fire um if I didn't hear that and could only see a fire in the house uh, there was, there was ample time to get out of the house before it was fully engulfed absolutely.

MH And there was ample ways to get out of the house?

JT Uh my understanding yes there was a front door um, there was windows pretty much through the whole house um and uh I never actually went to the rear of the house I don't know what type of exist were there um but yeah there was, there was plenty of opportunity to get out of there I thought, in my opinion.

MH How many S.W.A.T. calls have you been on, or S.E.T. call outs?

JT Um I'd say about eight (8) maybe ten (10).

MH And your estimation this was followed by, by your routine S.W.A.T. call out through your training and, and policy, everything was done properly?

JT Absolutely I think um, I think this was uh how we train, this is exactly what we prepare for and um unfortunately it ended the way it did but um as far as the tactics that we used, is something we practice and talk about um and then we preformed it that day um well I thought.

MH (Inaudible).

SQ I don't believe I have any questions either, uh that will end out taped conversation at fifteen (1500) hours.

End of transcript.

Transcribed by [REDACTED] 0608 on 9/20/2007.

HUMBOLDT COUNTY SHERIFF'S DEPARTMENT

CASE: 200703162
INTERVIEWER: Steve Quenell, Detective
SUBJECT: Attempt PC 187/ Officer Involved shooting.
STATEMENT OF: [REDACTED], Dispatcher
DATE & TIME: June 7, 2007 @ 1510 hours.
LOCATION: C.I. D.
ALSO PRESENT: Mike Hislop, DA Chief Investigator.

SQ Steven Quenell
MH Mike Hislop

[REDACTED]

SQ The following will be a taped conversation inside Humboldt County Sheriff's Office Detective Bureau, my office, I'm Detective Steve Quenell, present will be uh [REDACTED], Dispatcher with the Humboldt County Sheriff's Office and Chief Investigator Mike Hislop with the Humboldt County District Attorney's Office, our conversation will be uh basically about uh case number two zero, zero seven zero, three one six two (200703162) an incident that occurred up off of Bloody Camp road in Hoopa uh between the third (3rd) and the fourth (4th) of June of this year, uh [REDACTED] if you will could you tell me uh, well before we get to far (telephone ringing) into it here the time is fifteen ten (1510) hours, just a moment.

Detective Quenell. Ready for you. Okay. Sounds good. Thanks. Bye.

SQ Again it's fifteen ten (1510) hours and could you tell me how long you've worked for the Humboldt County sheriff's Office?

[REDACTED] Four (4) years and four (4) months.

SQ And do you have any type of special assignment working in that capacity?

[REDACTED] Tactical Dispatching, Senior Dispatcher.

SQ Have you received any type of specialized training?

■ Tactical Dispatcher.

SQ And where was that at?

■ Um here in Eureka, issued from a law enforcement agency down south, I can't remember, Mountain View I believe it was.

SQ Mm hmm.

■ Certified Tactical Dispatch Training.

SQ And how long ago was that?

■ Uh about six (6) months ago.

SQ And basically in summary, what's, what does a Tactical Dispatcher do?

■ Uh for S.W.A.T. call outs, keep track of units to handle all the radio traffic, just relieves all the, the traffic off the actual dispatcher center and brings everything to the Dispatcher that's on scene and can work tactical with the S.E.T. Team or S.W.A.T Team.

SQ Okay. So in this particular situation that we're going to talk about or you're going to talk about uh if you would, just in your, your own words, explain to me your involvement and what you know about it?

■ Okay. Well I was the Dispatcher on Duty that day, actually working in the Dispatch Center, the call came in from Tribal P.D. around two (2) o'clock requesting that we handle a welfare check because their unit was headed to the jail and we were unable to give them a transport unit at the time and they didn't have any units available. Uh the call was dispatched to Deputy Berry who is doubled with a Yurok Tribal unit, he advised he had an extended e.t.a. due to the fact they were in Weitchpec or further and they had, there by uh was putting minimal information on the first call so I contacted Tribal Dispatch again, they advise that uh the [REDACTED] they're Welfare Checking uh [REDACTED] [REDACTED] was [REDACTED] earlier in the day. They had sent units out to Welfare Check him and he had [REDACTED] and had been taken in to custody from there. At the time it was very minimal coming from their Dispatch Center, uh about probably forty five (45) minutes later, right around three (3) o'clock I think was when Q forty (40) went on scene and he was out with the R.P., I believe the mother and [REDACTED] [REDACTED] for quite a while.

SQ Who's Q forty (40)?

■ Uh Deputy Berry.

SQ Okay.

■ There were out there for awhile, they were status checked, advised they were Code four (4) and that they still hadn't attempted contact with the ■ it was probably about twenty (20) minutes later, I don't remember the exact time, when they advised that the ■ was in the residence, armed with knives and was not being compliant and they requested additional units expedite Um he was the only unit on up there so we had, we contacted CHP and CHP was en route with an extended ETA of about twenty five (25) minutes, uh the Yurok Tribal units that were on, twenty four zero eight (2408) and twenty four zero six (2406), I don't know their names, were en route from Weitchpec, from there to back. At that time X three (3) was just coming on duty, Sergeant Miller and he was advised of the situation and he advised he'd be en route, about that time the ■ Deputy Berry advised that the ■ was pointing a gun at the units and requested all available units expedite and that's when a duty officer was notified, Lieutenant Knight and I can't really recall a time frame of any of this, it was after three (3) o'clock but it was actually after four (4) o'clock when all this happened, um and there was conversations with the Duty Officer noting, notify him of what was going on, then he spoke with Sergeant Miller who advised that they should do a S.E.T. call out and the S.E.T. Team was or the S.E.T. call out was initiated from there. Uh at that time Q forty (40) or Deputy Berry kept advised ■ had a gun or didn't have a gun and his movement so we had an idea of where he was in the residence and where the units were um the Tribal units along with CHP got on scene and it was Sergeant Miller got on scene, everybody was pretty much, like all those units that were responding were out there around probably around five (5) o'clock around five (5) to five (5), it was actually about five (5) o'clock. Um we contacted Dispatcher ■ for a Tactical Dispatcher and I was able to call in ■ to work for me so I could go up there as well, you know this was the first time I had done, I wanted in on the training, so I met up with Deputy Daniels and got a ride up there. We got on scene at about probably six twenty (6:20) I think it was, we walked to the top of the road where we couldn't see anything and that's when we heard the first (1st) shots being fired. Both Dispatcher ■ and I walked back toward Detective Schlesiger's car and waited there for confirmation when it was clear to go in. Actually Lieutenant Knight got on scene and he came up from there and got us and went back down with Lieutenant Cavinta um after that it was documenting everything that had occurred uh we started scribing and notify Dispatch of all the movements the ■ was doing.

SQ Who was doing the uh documentation?

■ Uh Dispatcher ■ was doing most of it and I was backing up her on everything else, I believe she had all the correct documents with her.

SQ Where were you guys getting this information from?

■ Uh the units that were on scene, cause by then the S.E.T. Team was on scene and had um gone up to the residence where, we couldn't actually see so I don't know how far they were from the residence and they were notifying um A seven (7) of everything that was going on.

SQ Was the Command Post there at that point?

■ Not at that point.

SQ Okay.

■ We were set up at the vehicles that were on the roadway. Um so we were scribing everything that came in from who ever was talking on the radio, which was mostly Sergeant Quenell and it was to Cavinta and everything was documented and then some of the Tribal traffic that before we had got on scene, they had scribed, which we made sure we had copies of. That was all being handled and then we got a lay out of the residence and had all that blown up for all the units to see and it wasn't, everything was fairly quiet, negotiating started probably not long after we got there so it was probably around seven (7) when they started negotiations over the P.A.

SQ Who was your negotiator?

■ Sergeant Fridley and Deputy Daniels.

SQ Okay.

■ Uh that's when they begin the negotiations over the P.A. and then it wasn't until right about nine (9) o'clock everything had been fairly quiet when we heard the shots fired again and,

SQ How many shots?

■ The first, the first, it was different from the first (1st) shots that we had heard cause those were more of a banging noise, the second (2nd) round of shot was more of a whizzing sound and then we heard louder shots which we later found out that it was him shooting, was the whizzing sound and then our units firing back. Uh

SQ Okay

■ And that was like two (2) minutes till nine (9) um after that we retreated back to where the Lieutenant was, Lieutenant Knight and Lieutenant Cavinta and we did a roll call on all the units, which everybody advised that they were code four (4). Um and then after that it was fairly quiet again they were off and on with negotiations. By then the Command Van was on scene and due to it getting dark and the way all the cars were placed we started all moving vehicles out to get the Command Van in and get the road blocked off so we could get some of the units out of there, uh I think probably around ten thirty (10:30) eleven (11) o'clock, the C.P. was set up at the location at the top of the road, at the entrance to the drive way and that's when we started all this, the dispatching from inside of the Command Van and then it was fairly quiet, he made, the ■ made threats of having grenades probably around midnight I guess and then it was quiet until I left at one (1).

SQ Somebody told you this about the, the hand grenade.

■ It was Sergeant Garcia to Quenell and he advised that the C.P. hadn't been answering the radio, which they were unreadable for a while, and I had copied that and it was all documented in the log.

SQ Okay.

■ And then I left right around one (1) o'clock with Lieutenant Quenell or Knight.

SQ Lieutenant Knight?

■ Yeah.

SQ Okay.

■ That was the last thing that I had heard.

SQ Do you know about what time that was when you left?

■ It was right around one (1), it was a little after one (1) A.M. probably around one fifteen (01:15) probably.

SQ Okay.

MH Could you ever determine who was the original R.P., Hoopa um Dispatch (inaudible).

■ Uh they told us well it was kind of confusing because the initial call came from Tribal and they had dealt with it earlier in the day and it was ■ ■ who was calling for the mother I believe her name was ■ or something like that I can't remember her exact name, um so it was ■ to ■ to Tribal to us and that's where we had minimal information.

SQ Were you the only one (1) receiving calls?

■ What do you mean, like from Tribal?

SQ Correct.

■ Yes. Well there was myself and another Dispatcher were on duty, she's our trainee

SQ Mm hmm.

She actually took the initial call from Tribal, which Tribal had just advised that the [REDACTED] was [REDACTED] acting up in the residence, and I didn't know, obviously what that meant so I called Tribal to confirm further, being that she's in training

SQ Uh huh:

And they just said that um he had been [REDACTED] earlier in the day and [REDACTED] had called back stating that she got a call from [REDACTED] saying that he was there and he was acting up again and making statements of wanting to kill his mothers youngest child. That was actually a comment that was relayed to [REDACTED] first (1st) and was documented in the call and then they confirmed that with me and then um as Q forty (40) was advised of all that and then further directions, Tribal had actually called back and given [REDACTED] further directions and that was updated to Q forty (40) probably about twenty (20) minutes before he went out and right about the time he went out was when twenty five zero five (2505) and advised a little further on the situation that they had had a call with him earlier in the day and he had been acting out and the information regarding him being [REDACTED] a couple days prior to that and having to go to jail for the vandalism or whatever he did when he was [REDACTED]

SQ. Okay [REDACTED] do you have any uh thing else that you'd like to discuss that we haven't talked about that possibly may help shed more light on this incident?

[REDACTED] I don't think so no.

SQ Okay. That will earn, excuse me that will end our tape statement at fifteen twenty (1520) hours.

End of Transcript.

Transcribed by [REDACTED] 0608 on 9/20/07.

HUMBOLDT COUNTY SHERIFF'S DEPARTMENT

CASE: 200703162
INTERVIEWER: Steve Quenell, Detective
SUBJECT: Attempt PC 187/ Investigation.
STATEMENT OF: [REDACTED]
DATE & TIME: June 7th, 2007 @ 1535.
LOCATION: C.I. D.
ALSO PRESENT: Mike Hislop, DA Chief Investigator.

SQ Steven Quenell
MH Mike Hislop

[REDACTED]

SQ Okay the following will be a taped statement inside of the Humboldt County Sheriff's Office Detective Bureau uh the conversation will be conducted inside of my office, I'm Detective Steve Quenell, present will be [REDACTED], the spelling of her last name is [REDACTED] also present is Chief Investigator for the Humboldt County District Attorney's Office, Mike Hislop, we'll be discussing case two zero, zero seven zero three one six two (200703162) an incident that occurred up on Bloody Camp road or off of Bloody Camp road in Hoopa between June third (3rd) and June fourth (4th) again today's date is the seventh (7th) of June, the time is fifteen thirty five (1535) hours uh [REDACTED] how long have you been working for the Humboldt County Sheriff's Office?

[REDACTED] Three (3) weeks.

SQ Three (3) weeks okay and are you going through some type of training program?

[REDACTED] Yes.

SQ Do you have somebody that's training you?

[REDACTED] Yes.

SQ Okay. On the dates uh June third (3rd) and fourth (4th), did you have the opportunity to receive a phone call from someone regarding this incident?

■ On June third (3rd).

SQ Okay.

■ I received a call from Tribal Dispatch stating that they needed a Welfare Check done.

SQ Okay.

■ That was basically it.

SQ Do you recall who the dispatch was?

■ Uh it was a male, I don't remember his name.

SQ Uh huh and did they say anything else other than that?

■ I don't know why they were calling to request it other than his mother had gotten a hold of them stating that he needed a Welfare Check done and they called us to see if we could go up there and we did.

SQ Uh huh.

■ Um before we went up there I got a call from Mike Roberts, I don't recall his radio number but he was saying that he had prior contact with the ■ and he was in the jail and he ended up getting, well he was in ■ and he ended up getting violent and was transported to the jail and then he was telling me about how the ■ was saying that he had a dream that he wanted to kill his mothers child and that was, that was it.

SQ And this was relayed to you from Mike Roberts?

■ Yeah that information was yes.

SQ Okay.

■ He called dispatch and told me that.

SQ And at some point did you give this information to anyone else up in the dispatch center?

■ At that point the call hadn't been dispatched to any officers yet so I just put that in the call.

SQ Okay.

■ And I told ■ and she relayed it to who ever was going to be responding.

SQ And did somebody take over your position at some point?

■ Yes after I left um ■ she took over that's my trainer, ■.

SQ Do you know approximately what time it was when you left the console?

■ I left at three (3).

SQ At three (3).

■ Uh huh.

SQ And then ■ got into your position and continued the un conversation with Hoopa and the rest of the units that were going to get involved.

■ Yes.

SQ Okay.

MH So you just, you never dispatched any of the uh deputies?

■ Uh, uh. I don't dispatch any calls I just take,

MH You're just a call taker?

■ Yeah then somebody else does.

MH You just enter in the computer and (inaudible) the other side.

■ Mm hmm yes. I take the call, I put it in the computer and I say "hey I just put this in" and then they'll relay it. They don't let me talk on the radio yet.

SQ ■ is there anything else that we haven't during this conversation that uh may help shed more light on the incident that took place up in Hoopa?

■ Not that I know of.

SQ Okay. That will end uh this taped statement at fifteen forty (1540) hours.

End of transcript.

Transcribed by [REDACTED] 0608, on 9/20/07.

HUMBOLDT COUNTY SHERIFF'S DEPARTMENT

CASE: 200703162

INTERVIEWER: Steve Quenell, Detective

SUBJECT: Attempt PC 187/ Investigation.

STATEMENT OF: Kerry Ireland, Deputy

DATE & TIME: 06072007

LOCATION: C.I.D.

ALSO PRESENT: Mike Hislop, Chief Investigator, District Attorney's Office

SQ Steven Quenell
MH Mike Hislop
KI Kerry Ireland

SQ The following will be a taped statement made at the Humboldt County Sheriff's Office, Detective Bureau inside of my office, I am Detective Steve Quenell, also present will be Deputy Kerry Ireland. What's your date of birth Kerry?

KI One thirteen nineteen seventy five (1 13 1975).

SQ And also present is Chief Investigator with the Humboldt County District Attorney's Office, Mike Hislop uh we're part of the Critical Incident Response Team. The case number is two zero, zero seven, zero three one six two (200703162) today's date seventh (7th) of June. The dates that we'll be talking about uh regarding this incident will be June third (3rd), June fourth (4th) of two thousand and seven (2007). Kerry can you tell me how long you've been working for the Humboldt County Sheriff's Office?

KI Just over five (5) years.

SQ Okay. Before we get to far along here, the time is fifteen fifty (1550) or fifteen (15) yeah fifteen fifty (1550) hours. And are you currently part of the Humboldt County Sheriff's Office S.E.T. Team?

KI Yes I am.

SQ Have you received any type of special training um with the S.E.T. Team?

KI Uh I went to a basis S.W.A.T. course that was P.O.S.T. certified. I've been to a P.O.S.T. certified basic sniper course and then the training that we do with the team through out the year.

SQ How long have you been with the S.E.T. Team?

KI Uh I would say going on three (3) years.

SQ And what's your position with the S.E.T. Team, your function when you're called out?

KI I'm a entry team member and or, and or Sniper uh I get to play as a sniper.

SQ Okay. Can you tell us in your own words uh, your involvement with this incident that occurred up off of Bloody Camp Road in Hoopa between June third (3rd) and June fourth (4th) of this year?

KI That's really the name of it. Uh I received the, the page about sixteen hundred (1600) hours on Sunday. Our deployment page, responded to the office with Deputy Dave Lundie um we waited until our team leader Bryan Quenell and uh Garcia arrived, we got briefed on what was going on, we responded to Pine Creek of Hoopa uh I believe it was somewhere between eighteen hundred (1800) eighteen thirty (1830) that I arrived there, um it seemed within the first few minutes of my arrival uh shots were fired from the [REDACTED] house.

SQ Excuse me, had you been briefed prior to this, somebody explained to you what you were responding to?

KI Yes. Um we were told that at about fifteen (15), fifteen thirty (1530) hours today, uh that a call came in, I think it went in to Yurok but our agency was involved um it was a welfare check on a [REDACTED] that was making threatening statements who had a history of uh, uh [REDACTED] been [REDACTED] uh Deputy Berry and Yurok personnel arrived at the incident location, or where the welfare check was at, they were met I guess by the R.P. um who was informing them about this guys behavior, the [REDACTED] came out of the house and began pointing a handgun and started dry firing at um Deputy Berry and, and Yurok uh,

SQ What kind of gun was he dry firing?

KI From what I recall I, I think it was uh a handgun, it was a revolver type handgun, I don't remember the caliber.

SQ Okay. And somebody obviously is relaying this information to you?

KI Yes.

SQ Who would that be?

KI And that would, that was Sergeant Garcia um and Sergeant Quenell when we briefed at the Humboldt County Sheriff's Office uh prior to my arrival at the location.

SQ Did they ever mention who they had received that, their information from?

KI I don't recall.

SQ Okay. Go ahead.

KI Uh so we respond and like I said within the first few minutes I was talking with Sergeant Quenell about uh if he wanted me to deploy as a sniper to get eyes on the house and that was the plan when I got there that myself and Deputy Bishop were gonna find uh observation post within the first five (5) minutes that I was there shots were fired, um I believe that Brian Taylor who was on point returned fire, I don't know how many shots he fired, um I don't recall how many shots were fired at us at that time I believe it was, it was more than one (1). Um I deployed into the field with Deputy Bishop as a sniper, we were set up approximately fifty six (56) yards on the three (3) four (4) corner of the [REDACTED] residence, um I had visual of the four (4) "A" and four (4) "B" window as well as the three (3) "A", the three (3) "B" and the rear door. I don't recall the time, I believe it was around nineteen hundred (1900) hours, maybe after nineteen hundred (1900) hours I observed the [REDACTED] through my rifle scope open up the four (4) "A" window, I observed a rifle barrel uh extend out the four (4) "A" window uh I called out my observation uh at least two (2) or three (3) shots were fired from the [REDACTED] shortly after that um and then our team returned fire. I saw the impacts um from our team into the wall and window around the four (4) "A" window.

MH Stop one (1) second when, so you were, you were, you had binoculars or scope on him?

KI I had a scope yes.

MH When you saw the barrel come out of the window, could you see the shape, was it an octagon barrel or was it a regular smooth barrel or was it hard to tell?

KI Um it was a very strange thing first because when the window came out I saw what looked like the, the fat end of an aluminum bat as I was even thinking to myself, what is that. Um and then I saw whatever that aluminum looking item was extend out with the barrel so it was in the end of the barrel of the rifle and it, it looked like it was a black barrel uh it looked like you know how the, the lever action barrels are set up because I thought I saw um a magazine tube underneath it so it was just black round barrel.

MH Okay.

KI It, it was definitely a rifle barrel. I don't know what that was, I thought he was going to launch something at first because I couldn't tell what it was and it was sticking into the end of

the barrel. Um my only guess since I was relatively close to the residence, fifty six (56) yards away. Either it was a twenty two (22) or it was some sort of suppression system that he had concocted to stick in that barrel, cause it was in the end of the barrel.

MH Did you see a scope on the, on the?

KI No I didn't see a scope. I, I couldn't even see the [REDACTED] all I could see was his hands, uh and the rifle barrel. I had such an extreme angle on the four (4) "A" uh that I wasn't able to see the interior um through the four (4) "A" window so just saw his hands and the, the rifle barrel come out. Um so anyway uh I would say approximately six (6) shots were fired from our team after he fired upon us, uh that was the last time I believe he engaged us directly with gun fire. Uh I know that we had attempted to establish communication that day, Sunday before the sun went down several times, he never talked directly at us, he was sort of babbling nonsense that no one really could hear clearly that day, he was yelling uh things of that nature, uh sun goes down, we Bishop, Deputy Bishop and I uh exfiltrate from our, our "hide" cause we can no longer see inside the residence with our rifle scope. We come back to the command post we gear up as entry team um with our entry vest and our M sixteen (M16), we re deploy back to the rear of the house because the Hoopa Tribal Units that were watching the number three (3) side could no longer see cause they were too far away. Bishop and I set up again on the three (3) four (4) corner and we were practically right outside the three (3) "A" window, we were about maybe twenty (20) yards away, uh with night vision uh watched this guy mill around the house, several times you know from my training experience I could tell that his movements were not of a normal minded person, he was fidgety, he was talking to himself, uh he was talking like he was talking to somebody else when we had every reason to believe that there was no one else in the room, in the house.

SQ This uh nighttime or?

KI night time, this was Sunday night uh early Monday morning.

SQ Any lights on inside the residence?

KI He had the television on the whole time and it was loud, I mean he was blasting this television um,

SQ Are you looking at him through your scope or?

KI No through night vision.

SQ Okay.

MH It has no amplification?

KI No but I was twenty (20) yards away from at least, or at the most twenty (20) yards outside his three (3) "A" window. So I could see him clearly.

MH Did you see him flick at anything, flame or anything?

KI Yes I did. I couldn't tell if he was smoking, I know he, there was a wood-burning stove he started a fire, I watched him do that. Um I know that the four (4) "A" window, I don't know what he lit but he was lighting something because he wasn't flashlight flicker even though he saw him with a flashlight, it was flame flicker coming out of the four (4) "A" window and I don't know if that was late Sunday night or early Monday morning, it was dark um when I,

SQ When, when you were watching him with your night vision goggles?

KI Correct.

SQ Was he dressed?

KI Uh yes he was, I, I know he had a shirt on it was like a wife beater tank top. Um

SQ And you had mentioned that you saw him building a fire in the fireplace?

KI Oh yeah.

SQ Describe that for me, what you, what you saw?

KI Well I know that there was a wood burning stove because I could see the, the smoke tube going to the ceiling, it was, you know it wasn't a fireplace it was a wood, it was free standing wood burning stove. I can't see the wood burning stove, I know where it's at cause I could see the tube, um I know he build a fire because he was milling around that area and then I could see fire light coming from inside the residence so the wood burning stove it self is sit below my, my line of sights into the window. Um but you know through my observation I know he build a fire, I could smell the fire.

SQ Did you see anything coming out of the chimney?

KI Uh not during the night time hours, uh but I could smell it.

MH What, what window was this?

KI This was the three (3) "A" window and the three (3) "A" window is the window that I had uh the best observation on when I redeployed uh,

MH Is the fire, is the fire, the wood stove, is it next to three (3) "A" or where would that be?

KI If I, looking through the three (3) "A" it's, it's sitting, it's in the interior of the room, so I'm looking I would assume at the front of it and it's, it's got to be at least um six (6) to ten (10) feet beyond the three (3) window into the interior.

MH So okay so could you tell me where it would be in relation to the four (4) "A" window?

KI I was unable to determine if there was an interior wall separating the, where the four (4) "A" was to the three (3) "B", I know that when uh or where the four (4) "A" was in relation to the three (3) "A", I know that when I looked into the three (3) "A" I could also see the four (4) "B" window but I could not see the, the four (4) "A" window through the three (3) "A" window so if that's one (1) room, then it's in the same room, if it's, if the where the four (4) "A" window is at is a separate room, then that wood burning stove is gonna be right out side, probably up against the wall separating where the four (4) "A" and three (3) "A" windows are at, okay um so again he didn't, he didn't really do anything uh strange when I was in my second (2nd) observation post, um he was, he was acting strange like I said as far as talking to no one and, and milling around all night long, he milled around all night long, I was in that secondary observation position until approximately zero four hundred (0400) Monday morning. Um the guy never went to sleep um we exfiltrated again uh we went, we were probably, we moved to a different position, I was about fifty (50) yards off the number three (3) side, met with E.P.D. personnel who relieved us and they took up the position on the number three (3) side uh we returned to the Command van, we then left for the Hoopa Substation, this was around seventeen hundred (1700) hours or so.

SQ Were you relieved by somebody?

KI I mean zero five hundred (0500) hours. What was your question?

SQ Were you relieved by someone?

KI I was relieved by Sergeant Quenell, um I was informed dispatch the uh Emergency Dispatcher informed us that E.P.D. was on scene, approximately two (2) hours later um I was told through my coms. that E.P.D. would be arriving at my location to relieve me uh after they relieved me I returned to the Command post, Sergeant Quenell informed us that we are, E.P.D.'s gonna hold the perimeter, we're gonna go back to the Hoopa Substation uh eat up, rest up for a bit, brief and then return.

SQ During this entire incident, who's your supervisor?

KI Uh I was reporting pretty much directly to uh Sergeant Quenell.

SQ Okay were there any other S.E.T. supervisors on scene?

KI Yeah Sergeant Garcia had a uh a team that I believe that was set up on the number two (2) side of the residence.

SQ Okay. Do you know of any other supervisors?

KI Lieutenant Cavinta I believe was there through out the incident. Um

SQ Who's over all super, or uh in charge of the S.E.T. Team.

KI Uh Lieutenant Cavinta.

SQ Okay.

KI Um so we went to the Hoopa Sub, ate up, rested up a bit, briefed about what we were gonna do on Monday and the plan was that we were going to administer gas into the house, uh to gas this guy out uh believe the plan was that you know making entry was gonna be the final, final, last option, we did not want to go in unless we had to um so,

MH Why is that?

KI Because he was shooting at us.

MH Did you have any other Intel that he had any other guns besides the?

KI I heard so many different, I heard that he had the hand gun, um I saw that he had a small caliber rifle, um we had information that he, there was some sort of gun safe in there that he had uh an AK forty seven (AK47) or some S.K.S. type rifle but we had information that he had a hand grenade but that it was more and likely (inaudible) uh

SQ Would you consider him a threat?

KI Oh yes, yes I mean like I said within the first five (5) minutes of me getting there he shot at us.

SQ Up until now were there any negotiators on scene?

KI Yes there was negotiators uh soon after we arrived. Um and like I said negotiations began uh Sunday evening before the sun went down so,

SQ And, and who were the negotiators?

KI Um I believe that Jason Daniel, Deputy Daniels was there and I know that uh Sergeant Fridley was there um I was deployed in the field away from the Command post for the, the majority of this operation so I don't know what other negotiators arrived or what their structure was.

SQ Did you ever hear?

KI Yes.

SQ Anything that they were saying?

KI Yes. Um I heard both uh Jason Daniels and Sergeant Fridley, I could hear them clearly, could hear them clearly, what they were saying and kept telling him [REDACTED] it's not so bad, uh you need to come outside, leave your weapons inside the house, come outside, follow the instructions of the officer that meets you um you know repeatedly asking him you know we want to make sure that your okay uh and again repeatedly telling him that you know what took place isn't so bad, just come out. So and for them to, for him to talk, need you to talk to us um and it was basically the same uh, um announcement you know over and over again. Um I know that when the sun went down, during the nighttime hours on uh Sunday that it was no further uh attempts at communication from our negotiation team, we pretty much just sat on the house, locked it down. Um Monday we returned to the Command Post somewhere during zero six thirty (0630), just before zero seven hundred (0700), uh we were waiting on a negotiation team, I don't know if we were waiting on our negotiators to switch out with if E.P.D.'s negotiators uh since they were, they were on the scene while we were down at the Hoopa Sub. We didn't re-deploy into around the residence until approximately zero eight hundred (0800) and again we were briefed on what was going to go on that we were going to start administering gas into the house in an attempt to force him out of the house basically, pain compliance. Uh at approximately I again returned to the number three (3) side with Deputy Lundie as my uh support, I was again in the role of Sniper, um I was set up approximately fifty (50) yards off the number three (3) side and had a clear views of the three (3) "A", three (3) "B" and rear door, um Officer, so this was zero nine hundred (0900), um I would say that approximately ten hundred (01000) hours, somewhere between ten hundred (01000) hours and eleven hundred (01100) hours, not zero nine hundred (0900) is when negotiations began cause we went back in to the field at zero eight hundred (0800) hours, negotiations with the [REDACTED] began again at zero nine hundred (0900).

SQ Same negotiators?

KI Sergeant Fridley I believe was the only negotiator that day uh that was talking. Uh and this time he would begin I'm pretty sure he began ever attempt at communication with uh using his uh vehicle siren in attempt to get the [REDACTED] attention. Uh again, same type of negotiations, [REDACTED] we need you to talk with us uh we want to make sure that you're okay. Uh [REDACTED] you need to come outside, leaving your guns inside, follow the instructions of the officer that meets you outside. [REDACTED] you know the situation isn't all that bad just come outside talk with us, uh things of that nature and there were several attempts at communication on Sunday, by our negotiation team, to no avail, he, he never, he talked less Sunday, Monday when he was talking he wasn't talking, he wasn't talking at us, he was just babbling and yelling um, there wasn't even much of that on, on, on Monday. Um I honestly couldn't tell you when the first uh rounds of gas were administered, somewhere between, I would have to say eleven hundred (1100) and twelve hundred (1200) hours, that began with the Sheriff's Office S.E.T. Team um using thirty seven

(37) forty (40) millimeter uh launched gas canisters. I don't know how many of those we fired I saw two (2) malfunctions and I think at that point, after talking with Deputy Barney, they, they stopped firing the thirty seven (37) forty (40) millimeter into the house because the two (2) malfunctions.

SQ Somebody give the order to deploy gas?

KI Uh yes uh at that time I, I, I would, I don't recall if that was Lieutenant Cavinta or Sergeant Garcia or Sergeant Quenell that finally gave those orders, I would, I would, it would have to one (1) of the two (2).

SQ Okay. And from where they were deploying the glass, the gas, excuse me, how far away from them were you?

KI I had to be anywhere between seventy (70) and eighty (80) yards, they were deploying on into the number four (4) side of the house.

SQ So you could actually see them deploying the gas?

KI I didn't see the personnel, but I could see uh, I could see the, where it was discharging from basically. Uh I couldn't see the impacts into the house because I didn't have, a view of the number four (4) side, but I did see two (2) uh, uh failures, basically the cartilages detonated outside.

MH So when that was happening you were, you, you were deployed as a Sniper again?

KI That's correct.

MH So you had your scope on the house.

KI That's correct.

MH Did you see any movement in the house what so ever when the gas was going in?

KI Um you know I heard movements. I didn't have a view into the interior of the house any longer through the three (3) "A" window. I think he had put something up um, because I was looking through the three (3) "A" window all morning long before the sun came up um and when I returned to the number three (3) side with my Sniper rifle, I could no longer see through the three (3) "A" window uh three (3) "B" window was, couldn't see through it, there was no window in the rear door, so I had no when I re-deployed as a Sniper on Monday I no longer had visual inside the house. Basically I was covering the rear door in case he uh exited, heard movement several times when the gas began um I believe after the two malfunction with the gas canister, our team stopped administering gas and E.P.D. started. E.P.D. deployed gas using the thirty seven (37) forty (40) millimeter launcher and twelve (12) gauge ferret rounds, they

administered gas for the number two (2) side, they administered gas for the number three (3) side, and they administered gas into the number four (4) side.

SQ Did you actually see them?

KI I saw, I saw them administer gas into the number two (2) side, they were about twenty (20) yards behind and above me, when they administered into the number three side.

SQ Do you have any idea who, who that was that?

KI I don't.

SQ Okay.

KI I don't, I don't even know all their personnel names. Um and I could hear the impacts um going into the number four (4) side. Uh and again, pretty much after every time, every volley of gas that was administered in the house, negotiations would begin again, an attempt at communication would begin again, and instructions to exit the house without any weapons began again. Um and again there was no communication and the [REDACTED] after each volley made no attempts of exiting the house. I never saw the rear door open up. Um later in the afternoon uh Sergeant Quenell and his team uh used a ballistic blanket and I porting tool and they ported the four (4) "B" window, I believe it was and threw in a C.S. grenade and then they uh retreated. I never saw any movement then either um still could hear him occasionally bouncing around in the house doing whatever.

SQ Now did you actually watch them approach with the blanket?

KI Yes.

SQ Okay.

KI I did.

SQ And who was in, in that team that, that you were watching?

KI Um I, don't think I can give you all their names I know it was Sergeant Quenell, uh Deputy Barney, uh Deputy Gomes, I believe Deputy Taylor, uh Jesse Taylor um and that's all I can accurately say. I think there was one (1) more person. Um and again this was uh a smaller type C.S. grenade.

SQ Did you see who actually deployed it?

KI No I did not.

SQ Okay.

KI Um unknown time after that they uh moved towards the house again, Sergeant Quenell and his team, using the ballistics blanket and the porting tool and I believe, I don't know cause I had no visual, um you know at this point I changed positions I was still on the number three (3) side, but I was about seventy (70) yards out at a more elevated position and that's why I had uh pretty good visual approach to the house and what windows they were, they were uh porting. I still did not have visual of the four (4) side, definitely did not have visual of the four (4) "A" side, but the second (2nd) time they approached the house I could tell from their angle that they ported what was left of the four (4) "A" window and they administered another uh C.S. grenade. I could tell this was a larger grenade, because of the amount of gas that was coming into the house. The wind blew to, towards our direction so I could tell it was C.S. because it effected me. Um I had to put my gas mask on um,

SQ How did it effect you?

KI Uh burns the skin around the, the exposed skin around your neck, um causes irritation in your throat um that's pretty much it you know stinging in the eyes.

SQ Okay.

KI Uh lots of gas coming out of the house um for several minutes, uh I then at, so at this time, like I said when, when they, when they were doing the approach with the ballistic blankets, I was now about seventy (70) yards behind and above the number three (3) side with Dave Lundie, Deputy Lundie and members of E.P.D. S.W.A.T., Sanchez um Tim Jones, I believe his name is and we were all covering the, the number three (3) side. There was approximately five (5) or six (6) E.P.D. personnel with me um at that time. Uh we noticed a change in the color of the smoke coming out of the house, which led me to believe that there was no longer gas, that it was smoke and that something was burning, this was several minutes after the last canister of, of C.S. was administered. Um the smoke started to darken which confirmed that it was no longer gas and that something was um smoldering or burning inside the house and this was coming out the four (4) side, number four (4) side is where I observed the smoke coming out. Uh

SQ This is where the last canister was put in?

KI Correct. The last two (2) canisters. Um when it was, I could smell that it was no longer C., no longer C.S. and that it was you know something was burning um and that it was soon after that the observations were being called in to the Command post that something appeared to be, that smoke was coming out of the house and it appeared to be uh um burning inside the house that again negotiations began, negotiations began after, right after that last canister was deployed, um and again once it was confirmed that something was uh burning inside the house, negotiations began uh there was several attempts uh to negotiate to communicate with [REDACTED] when the house, when it was clear the house was on fire. Several attempts, instructing him come out side, got any weapons, follow the instructions, um several attempts, I couldn't even tell you how

many, it's a lot. I could hear movement inside the house when it was clear that there was something burning on the number four (4) side, um about the time that I started seeing flames on the number four (4) side, I heard uh what sounded like gun fire inside the house, it was approximately three (3) or four (4) um pops that sounded like small caliber firearm, um I heard a lot of movement on the number three (3) side, around the rear, rear door area. Uh the number four (4) side became engulfed in flames, it was actively burning um that was pretty much it, the fire started moving from the number four (4) side to the number two (2) side and again there was uh no attempts of the [REDACTED] to exit to house uh

MH So between the time the black smoke started and the time that the uh whole structure was fully engulfed, how long was that?

KI It, it was a slow burn.

MH So how long, okay, just estimate?

KI I would say that when I first observed smoke, that it had to be at least, at least thirty (30) minutes before I saw flames. It was a slow burn.

MH And it, it, and it most of it was in the four (4)?

KI On the number four (4) side.

MH Which is the front part of the?

KI No. That's on the, what is that, I guess that would be the north side of the house. The front house is number one (1).

MH Okay.

KI Uh no, it would be the south side of the house that's number four (4).

MH Right.

KI Um so number two (2) is going to be the north side, number three (3) is the east side and number four (4) side is going to be the south side.

MH Okay so the south side is where it started?

KI Yes.

MH Any, in your estimation any reasonable person would had plenty of time to get out of the, through the back door?

KI Oh most definitely, most definitely um like I said, it was, it was, it was a slow burn, it, it was several, several minutes after I first saw smoke that I saw flame um and there was considerable, considerable amount of smoke before I saw flame so I mean, any, I would have left the house, with that much smoke, I would have been out of that house.

SQ The second (2nd) time that they approached with the blanket,

KI Yes.

SQ Did you see who uh tossed in the, the gas that time?

KI Mm hmm. Uh I didn't see who initially tossed it but I know that there was uh again uh a deployment error cause the grenade didn't go inside the house when it was deployed and I believe it was Sergeant Quenell who picked the grenade up off the ground and got it inside the house.

SQ And there was?

MH Was it a smoke grenade or a uh?

KI No it wasn't, it wasn't smoke, it was C.S. this was a large C.S. grenade.

SQ And there was two (2) on the second (2nd) approach with the blanket, there was two (2) that was tossed in?

KI Yeah there, no, I don't know if there was two (2) tossed in, I thought it was only one (1).

SQ Okay.

KI There was two (2) approaches on that side with the

SQ Correct,

KI Ballistic blanket.

SQ Correct.

KI Uh but I only know of one (1) grenade on the second (2nd) time that was deployed.

SQ Okay.

KI I could only see one (1),

SQ Right.

KI Cause it hit the ground, they had to re-deploy.

SQ So once the place is fully engulfed, what happens?

KI Um I wouldn't even say that it was fully engulfed yet, once the flames became uh really active on the number four (4) side. Uh the Command post requested that uh that fire responds, fire was staged and requested that fire you know come down and uh and, and do their assault on the, on the house, on the fire um so about, I would say about what about half that house was in flames, that I could see uh fire responded to the house, both uh S.E.T. personnel and C.D.C. C.I.R.T. who had responded uh to the location, that's there uh enforcement team, from Pelican Bay, they provided uh cover, firearms cover for fire personnel um when fire started deploying their hoses and at that point the house was pretty much engulfed, um I would say about eighty (80) to ninety (90) percent um I left my position and went down to the number two (2) side of the residence and linked up with Sergeant Garcia's team and at that time uh you know I could see flames coming out of the, the roof vents on, near the number two (2) side uh seemed like fire personnel you know did a pretty good job of knocking the fire down, once they arrived uh they ported the number one (1) side with a chainsaw into the wall, said that they had observation of the [REDACTED] in, in the bathroom on the number one (1) side through the hole they made into the wall. I observed the [REDACTED] uh he was naked, I observed what looked to be burns, saw what looked to be soot, maybe ash on his body and I saw no movement, and I took that as a sign of his dis, you know his decease. Uh I saw that the fire chief was going to breach the rear door, once I saw him return I spoke with the fire chief and asked him if the rear door uh was (inaudible), was it barricaded, was it screwed or nailed shut and he said no, it was just locked, um which led me to believe that he could have exited that rear door at any time. Uh at that point uh we returned to the Command post and waited for the Deputy D. A. Investigators to start doing their part of the investigation.

SQ What was that?

KI Um record our names uh names of the S.E.T. personnel uh photograph us, uh record our, the serial numbers of the weapons we had on our person, each person and the amount of ammunition in those weapons, caliber, serial numbers, number of ammunition.

SQ And then what happened?

KI After, after I provided that information, I, I gathered my gear and uh once I got the O.K. from Sergeant Quenell that we were able to clear the scene, I cleared the scene, cleared the scene about, it was almost eighteen hundred (1800) hours Monday.

SQ Okay I just have a few questions for you Kerry um what kind of firearms did you carry with you during the incident?

KI Um when I first deployed Sunday I had my Glock caliber forty (40) um and forty six (46) rounds of forty (40) caliber of S. and W. uh I deployed with my Sniper rifle which is Remington

seven hundred (700), caliber two, two three (223) um I had five (5) rounds of match grade Boat tail uh loaded in to the rifle and I carried another twenty seven (27) rounds with me, yeah.

SQ During that incident did you ever fire any of your weapons?

KI No.

SQ On your rifle, did you have a scope?

KI Yes.

SQ What kind of scope did you have?

KI It's a uh, uh Leopold's um tactical forty five ten (45X10) powered, it escapes me at this point.

SQ During this incident did you ever see any patrol units that were fairly close within the same area that the uh that the uh incident was occurring?

KI Yeah. When I arrived, I think the, the, the closest patrol car to the house was at least one hundred (100) yards away,

SQ Uh huh.

KI And that was I believe uh a Yurok vehicle, um and that, that vehicle was facing basically the four (4) "A" window uh, every time the [REDACTED] fired upon us I'm pretty sure that's what he was firing at, um I saw what I, I guess, you know cause I didn't really look at it but I didn't see, I what I believed was uh Deputy Berry's, Greg Berry's vehicle that was facing the one (1) two (2) corner, it was on the road,

SQ Mm hmm.

KI Hoopa Tribal had a vehicle that was pretty much facing the two (2) three (3) corner, it was facing the number two (2) wall, the number two (2) side but they had set up so that they were looking down the number three (3) side, so they were holding position to observe if there was any attempts of uh exiting from the uh rear door and then we had a bunch of vehicles set up on uh the number four (4) side, that's where we were coming in and out at.

SQ How many vehicles would you consider would be within a critical zone of the incident, the residence?

KI I believe three (3), the one (1) that was closest like I say had to be at least a hundred yards, um on the number four (4) side and that's where we were setting up S.E.T. personnel to have eyes on and, and weapons uh down at the number four (4) side, and it was Greg Berry's, I

assumed it was Greg Berry's on the number one (1) two (2) corner on the road, and then Hoopa Tribal who are using their vehicle as cover and concealment to have observation of the number two (2) and number three (3) side of the residence.

SQ Were there any emblems or anything else on those vehicles that would indicate that they were law enforcement?

KI Yes um I know that the vehicle that was set up on the number four (4) side uh I you know what I, I honestly couldn't tell you if there was any light bars on, on that vehicle but there was definitely emblems on the door and the door was, the drivers side door was open because uh I know that Deputy uh Brian Taylor was using the open door as cover and concealment. Uh I know that Hoopa Tribal there was one (1) their S.U.V. patrol vehicles um it was clearly marked, uh the other vehicle um I really didn't linger long enough to take observation of it, uh but again I believe, I believe that all three (3) of those vehicles that was closest to the incident were clearly marked as law enforcement.

SQ Okay.

KI Not to mention every time uh Sergeant Fridley got on the radio uh you know he would say you know this is Mike with the Sheriff's Department so,

SQ Okay.

MH I don't have anything.

SQ Kerry is there anything that we haven't discussed that you feel may uh shed more light on this incident that we're been discussing?

KI I don't believe so.

SQ Okay. That will end uh this taped statement at sixteen thirty six (36) hours.

End of transcript.

Transcribed on 10/5/07 by ■■■ 0608.

HUMBOLDT COUNTY SHERIFF'S DEPARTMENT

CASE: 200703162
INTERVIEWER: Rich Schlesiger, Detective
SUBJECT: Attempt PC 187/ Officer Involved Shooting
STATEMENT OF: Louis Altic, E.P.D. Officer.
DATE & TIME: June 8, 2007 @ 0602 hours.
LOCATION: Eureka Police Department, Eureka, California
ALSO PRESENT: Steve Dunn, D.A. Investigator.

RS Rich Schlesiger
SD Steve Dunn
LA Louis Altic

RS Synchronize you.

SD I think we're on.

RS Okay date is June eighth (8th), two thousand and seven (2007) time is zero six zero two (0602) hours. Case two zero, zero, seven, zero three one six two (200703162), uh we're at the Eureka Police Department uh present is Detective Schlesiger, Investigator Dunn and Officer Louis Altic. Louis what's your middle name?

LA Winton, W-I-N-T-O-N.

RS A-L-T-I-C.

LA I.C.

RS And your badge number?

LA Eight nine (89).

RS So that's three (3) "B" eighty nine (89) then, your call sign?

LA Mm hmm. Mm hmm.

RS Okay and how long have you been in law enforcement?

LA About four and a half (4 ½) years.

RS All with Eureka, okay and um what are you currently assigned as?

LA Just patrol.

RS Okay and are you a member of your SWAT Team?

LA No I'm not.

RS Okay. Um

LA I'm, I just got sent to some training to uh for Chemical Agents sort of as a support roll that uh, I'm on a patrol rifle so I sometimes get called out with them.

RS We, we, told, yeah we talked to Nova and he said something about patrol rifleman?

LA Mm hmm.

RS That also assist the SWAT Team, is that what you would be?

LA Yes.

RS Okay, how long have you done that?

LA Um I don't know exactly when I got on to the patrol rifle but maybe close to two (2) years.

RS Okay. And can you kind of explain that, that job?

LA Uh as patrol rifle, we'll sometimes get called out with SWAT to do support type services like a perimeter type work.

RS Okay and when did you uh go to training uh for Chemical Agents?

LA Uh it might have been March or April. Recently.

RS Okay, and where was that at?

LA Down in um Dublin.

RS Okay.

LA I think it was Alameda County.

RS And going back to uh June third (3rd) um were you working that, that night or how, how did it come about that you were called out to assist?

LA I, I received a page and a phone call.

RS Okay, and who was that from?

LA Uh the page I think came from Dispatch per Nova and I think the phone call message was Sergeant Johnson.

RS Okay, and was it to meet here at the Police Department?

LA Mm hmm, yes?

RS And when you, when you guys, how many other rifleman were there when you, with you?

LA Greg Hill and,

RS Cooper?

LA Cooper. I can't remember who else.

RS Okay, and uh you guys meet here, were you guys briefed at all?

LA Yes.

RS Okay and what were you told in the briefing?

LA We were told that we'd be going to assist the S.O. with a barracked [REDACTED] basically we were going to be um relieving them for a period time in order to give them a rest period and that was our initial roll that we understood we were going to be going to then uh see how else we could assist them.

RS Okay and when, did, you're working graveyards, were you working graveyards at that time?

LA I was that was uh one (1) of my days off.

RS Days off okay, and um you guys are briefed probably around twelve thirty (12:30) in the morning?

LA Mm hmm, yes.

RS Okay, and you guys respond up to Bloody Camp Road in Hoopa?

LA Is that what it's called?

RS That's what it's called.

LA That's uh, that's right we loaded up uh I think three (3) vehicles, four (4) vehicles maybe,

RS Okay and did you uh take you uh Chemical Agents with you?

LA We did.

RS Okay, and um I believe you guys probably arrived around uh two thirty (2:30) three (3) o'clock in the morning?

LA Sounds about right, I'm not positive

RS Okay.

LA When we got there (inaudible).

RS When you get there um there's the Command post and um are you guys dispersed out from that location?

LA Yes we uh spoke with uh probably Cavinta and then they told, they, they uh divided us in to partners, pairs um I was partnered with Rodrigo Sanchez and um we waited for S.O. SWAT, or what do they call them S.E.R.T.?

RS S.E.T.

LA S.E.T. um to as, they had people who were going to guide us out to certain position around the perimeter of the property and um Sanchez and I ended up waiting for quite a period of time before our person came back and took us out to our position.

RS Okay um Louis we've got somewhat of a sketch here,

LA Mm hmm.

RS um the tribal vehicles that were near the residence the Yurok uh vehicle that was parked also near the residence, more towards the north,

LA Mm hmm.

RS Um and also Bloody Camp Road and kind of where the um Command Post was, where were you guys taken to um where did you guys stage at?

LA Okay. Sanchez and I were, were taken up on to the number up on to the number three (3) side.

RS Okay.

LA And we started off on a, what we started off replacing a couple of deputies um kind of on a lower plateau, just a grassy area, we were prone out and we watched from there uh through hours of darkness and as it started to get light, we pulled back a little bit to a little bit higher position near some trees.

RS Okay can you put your initials and Rigo's initials in there? Okay and uh when you first get there is there um anything that you see or hear in the house at all?

LA Mm hmm.

RS What is it?

LA Uh initially during the first part of the, our stay there, um we saw the, the [REDACTED] uh through this window, the 'A' window we called it, the one (1) farthest to the,

RS It'd be the 'A' window on the three (3) side?

LA 'A' window on the three (3) side,

RS Near the three (3) four (4) corner?

LA Mm hmm, correct. We saw him through that window at least one (1) time, uh we saw that he had a white t-shirt on at that point in time he uh pulled back from the window a little bit and lit something, perhaps a cigarette or something like he was using some sort of a little flame or lighter, at that point um I think that's probably the only time we really saw him, we did hear some movement, and hear some banging here and there.

RS Okay and were you advised that the [REDACTED] name [REDACTED]

LA Correct we were.

RS And um at the time you guys arrived, was there any uh attempts for negotiation going on?

LA There wasn't any going on at right away no.

RS Okay and as daylight arrives you guys kind of move back some to get back more into a, a safety position?

LA Correct.

RS Okay after that occurs what goes on next?

LA We continued to watch uh for a period of time as it got lighter and then um I don't know exactly what time but two (2) deputies returned uh we were up farther near a tree and um two (2) deputies to the lower grassy plateau area and um shortly after that we were told that we could uh respond back up to the, to the Command center,

RS Okay.

LA Command Post.

RS So you and Rigo go back there um and was that the time you guys tried to get some rest and stuff?

LA Uh they had some coffee and uh food there,

RS Okay.

LA And um we were back there for um I don't know how long but a period of time.

RS Okay when you, when you guys came back uh did you hear any negotiations starting up anytime during the time before you were deployed out again?

LA Yes the negotiations started some point in there um, I remember watching some negotiations from I, I, I walked out here a little ways until I could clear, just clear, and see this um, these vehicles, and I, I heard the negotiations going on while I was back here,

RS Okay.

LA While I was able to move around back here at the Command Post, I just don't know what time,

RS So you, okay.

LA It was started.

RS Okay. You went up to the point where you could see the back, Tribal police vehicle?

LA Correct, mm hmm.

RS And see them negotiating. Did you hear over your radio or anything like that, that anyone from inside the house was responding to those negotiations?

LA No I never heard of any responses to it.

RS Okay. Um and what did you do next then?

LA Um I, I didn't remember, I, I remember walking up towards these vehicles because I'd heard that they were also planning on, on uh deploying some chemical agents from the vehicles.

RS Okay.

LA And I just wanted and I hadn't see this side uh yet so I, I went up to just see what kind of distance they were gonna have to shot uh the chemical agents and um so, so like I said I don't know the time but that's the, the, the period that I was there.

RS Okay. And Louis when you looked at that residence does that appear the right positioning of it or should it be maybe tilted a little more that way?

LA that way, yeah I would say tilted more uh these, this position would have had a more direct uh shot at this side of the, the building, I would say that, that if (inaudible) from these vehicles the building would have been um

RS So the four (4) side would have almost been facing right towards the vehicles?

LA Pretty close yeah, it was at a little bit of an angle but not much.

RS Okay and after you return back to the Command Post um you hear negotiations continuing, okay and what eventually happens, are you deployed?

LA Eventually um they, they, they did negotiations and then eventually while I was still back here, they started um deploying chemical agents from the vehicles.

RS Okay and that was they would be the S.O.?

LA Yes.

RS Okay.

LA And um they, they, they alternated between the chemical agents and the negotiations for some period of time and then uh they told us that we were going to try to get a position over on the number two (2) side in order to deploy chemical agents.

RS Okay and on this day, who was the Chemical Agent people?

LA Uh it would have been myself and Tim Jones who I, I'm sort of moving into the Chemical Agents, Tim Jones has been doing it for as long as I've been here, longer.

RS Okay and so I'm taking it you two (2) move in to the number two (2) spot or number two (2) side?

LA Yes in fact the whole E.P.D. group went around to that side.

RS So your whole,

LA Number two (2) side.

RS The whole team moved into the number two (2) side?

LA Yeah including Greg Hill and myself.

RS Okay, and how did you guys come into that position?

LA (Inaudible) into that position?

RS Yeah.

LA Um we, we, we went up starting pretty much right at the Bloody Camp Road, and, and went sorta behind this hill.

RS Okay.

LA And dropped down through some trees on the north side,

RS Were you directly in the number two (2), facing the number two (2) side?

LA Yes we would have been, we had a pretty straight angle at the number two (2) side uh we would have been towards the two (2) three (3) corner, slightly there was uh, there was uh um a sniper set up somewhere to the west of us, just slightly to the west of us on, on, we thought on the other side of a fence that runs somewhere over here.

RS And that would have been an S.O. Sniper?

LA That would have been an S.O. Sniper, so we stayed to the east of his location and uh were kind of pretty much straight off the number two (2), number three (3) corner.

RS Okay, can you just put a circle with your initials in there? Okay and you guys set a position there, your whole team and you and Jones as the, the gas guys um from that location, can you hear, I don't know at that time who was negotiating but whoever was negotiating could you hear their commands or, or attempts at negotiation?

LA Yes.

RS Okay. Was it clear to you?

LA Um it was clear but not, not overly loud.

RS Okay.

LA You had to be, you had to be listening to be able to.

RS And how from the number two side, how much farther are you back behind it?

LA Um they brought a uh, uh range finder and we were about eighty one (81) yards is what they had told us.

RS Okay and um what happens after that?

LA Uh at some point they, they uh told us to attempt to deploy the, our gas, um,

RS Did you receive that direction from Nova?

LA Yes and um I don't remember the exact transmissions but we heard, we heard communication between uh from S.O. as well.

RS Okay and how, how did the, when you guys delivered the gas, how did that go about?

LA It went about that um I think they were uh, they told us how many rounds to um think they tried, they tried to get, I can't remember the numbers but I think they, they told us to start with ten (10), ten (10) rounds I believe. Uh at some point they told us some series of uh you know to try five (5) and then another five (5) um but I can't remember that exact directive um they pretty much ended up we shot until we got a few in,

RS Oh I'll bet. And when you were shooting in, or attempting to into the, the residence or trailer, was there a window back there?

LA Yes there was, we were attempting to get to get some rounds through the window.

RS Can you show me where about, where that window would be?

LA Mm hmm. Uh there were two (2) windows and I don't know how far over, it was near the two (2) three (3) corner.

RS Okay.

LA Were there one (1) window or two (2) windows on that side.

RS Okay.

LA I think we were just trying for the one (1) window, (inaudible).

RS Okay and um, so it's you and Jones, and um I'm guessing it was thirty seven (37) millimeter?

LA Thirty seven (37) millimeter.

RS And did you guys each have one (1) or did you share one (1)?

LA We each had a um a launcher.

RS Okay.

LA And um we laid out the five (5), the five (5) rounds that each uh that we were going to shoot, uh he fired three (3), I fired two (2) initially for the couple of courses of, of fire.

RS Now did you, when you guys fired three (3) and fired two (2),

LA He, he would fire, then I would fire, he would and I was, I tried to watch where his rounds were landing, we talked about where, our sight you know where we were, how we were uh setting up our site picture, where we were setting our sights, we were trying to figure out where the things were gonna go.

RS Okay.

LA So he'd fire, I watched what happen to his, I'd fire, we were trying to adjust in order to get something into the window.

RS Okay and is that the C.S. powder?

LA Yes.

RS Okay and um do you guys do that, that first little volley, Jones three (3) you two (2), do you guys get any into the window?

LA I can't remember if we got any the first, first round.

RS Okay and then are you guys requested to, to attempt more?

LA Yes.

RS And how does that go about?

LA Uh I believe they just wanted to, we um announced what we, what the results of our uh each volley were um I think they wanted uh, uh a number of them in there and we didn't reach that number until we fired I believe twenty one (21) rounds.

RS Okay. How many did they want in there?

LA We got, I think we got six (6) in all together, I think they wanted, I think they wanted ten (10) on that end of the building.

RS Okay.

LA We never, I know we never reached what they wanted, we, we finally ended up telling them it's, ineffective, we're wasting uh the, the ammunition, you know the rounds uh we've gotten about what we're going to get in there.

RS And, and why was that?

LA Just cause of the distance and the wind.

RS Obviously you'd just been to training, what is the effective range of the thirty seven (37) millimeter launcher?

LA Well when, when we, when we uh fired the uh ferret rounds, which we, is what we were using um at the training, we were firing at under fifty (50) yards, um I don't believe they told us a, a range that you know could or couldn't,

RS There's all sorts of ranges but just as far as,

LA The conditions yeah.

RS Where you guys were at, at eighty one (81) yards.

LA Was extreme, yeah it was on the long end of being effective. They were losing power um,

RS Those launchers aren't the most accurate of things.

LA There not the most accurate and, and the, the round is losing power by the time it gets to you know that kind of distance anyhow.

RS Okay.

LA They were able to penetrate a window but they were bouncing off the siding of course.

RS Okay. But were these one's (1's) made if you were within the distance to go through a wall though?

LA Um they would go through some kind of, some light um perhaps plywood's or sidings,

RS Okay.

LA Uh I don't know if they'd go through two (2), two (2) things of,

RS Okay.

LA Yeah they'll punch through some you know like interior doors and you know hollow core type materials like that.

RS Okay and you guys shoot about twenty one (21) rounds from that location?

LA Mm hmm yes.

RS Getting about six (6) in?

LA Correct.

RS Okay and are you guys advised to move anywhere else from that location?

LA Yes.

RS Where to then?

LA Uh from, when we advised them that we felt we were being ineffective or, or, you know, we were told to try to find a position on the number three (3) side.

RS Okay and did you move to that side?

LA We did.

RS Okay was it you and your whole team again?

LA No. Two (2) team members stayed on the number two (2) side, I believe that was Cooper and, and Johnson.

RS Okay.

LA Uh the rest of us moved to the number three (3) and we took a position by the trees that Sanchez and I had been at before.

RS Okay and um what were you uh advised to do from that location?

LA Uh we waited for a while, they did some more uh, they did more negotiating and more uh chemical agents from the vehicles um and at some point they told us to uh try to get more rounds into the number three (3) side.

RS Okay and that was you and Jones once again?

LA I ended up firing all the rounds from the number three (3) side.

RS Okay. Where did you attempt to put those rounds in at?

LA I, I started off, my first attempt was over here at the "A" window.

RS Okay just put 'A' in there for me then.

LA Yeah. I missed the first one (1), got two (2) in on the next two (2) shots,

RS Okay.

LA And then I shoot at the 'B' window and I got those, the, those two (2) shots in and stopped.

RS Okay. So all together you shot five (5) getting four (4) in?

LA Yes, correct.

RS Okay and during this whole time, you, you hear negotiations or attempts negotiation going on?

LA Yes, there, there was sort of alternating pattern of negotiating and, and chemical agents going on.

RS Okay and the S.O. guys, did you see somewhat they were putting into the number (4) 'A' and 'B' side?

LA Um I don't know everything that they were putting in, I think that they were initially put in ferret rounds, I think that, that's what they're using, I don't know for sure uh at some point I know that they used some shotgun rounds um, I, I don't know exactly which type and I think there objective at that point was to clear some glass.

RS Okay and, and is that when they hand delivered the stuff?

LA And then shortly after that they hand delivered something, I don't know what.

RS Okay and um after they hand delivered, I'm guessing canisters and the, was there smoke coming from the residence?

LA Yes there was um, they hand delivered um (inaudible) put off some smoke,

RS Okay and in your in your experience and training, um did that appear to be the same color, like uh C.S. smoke type of um, uh canister.

LA It was a white, white smoke.

RS And at any point did the white smoke, the white smoke dissipate and go away?

LA Uh huh, in fact the first two (2), seeing that the first two (2) rounds, or the first two (2) hand delivered uh I don't know (inaudible) uh I don't know how many they threw, the first time that they went forward and hand, hand delivered some uh smoke, there was some smoke but not as much as the second time, I don't know if it was just uh I don't know if it was a different material or if it just was more effective for, for some reason.

RS Mm hmm.

LA Uh I don't know where they, it ended up going inside the house. The second time uh they hand delivered there was much more white smoke.

RS Okay. And were negotiations continuing or trying to after that point?

LA Yes.

RS At any time did you notice uh a different color smoke coming from the residence?

LA Yes, quite, some period of time, quite a long period of time after the uh hand delivery uh we saw some darker, gray, brown smoke.

RS Okay where, where was that coming out of?

LA Um mostly it coming out from the number four (4) you know the number four (4) side.

RS The "B" window?

LA Closer to, probably closer to the 'B' window yeah.

RS Okay. And, and even at that time there's still negotiating continuing or trying?

LA Yeah. Yeah.

RS Never you, ever hear a response or anything?

LA No never heard a response.

RS Did you see anything, any movement, anything like that?

LA Um never saw any movement, we I thought we heard some, I thought we heard some sounds during the course of you know the, the later, I don't know if it was before or after the hand delivery but we thought we might have heard some sounds.

RS Okay and from,

LA Just thumping and,

RS Okay. From the point of the white smoke to the black smoke he, can you estimate about how long of a time that was in between those?

LA Mm more than an hour.

RS Okay. Okay and um eventually do you see flames coming from the residence?

LA Yeah along time later, it took a long period of time.

RS Okay.

LA From the point that we uh first saw any kind of change in the color, to the point where we actually saw some flames was uh properly a few hours.

RS Okay.

LA Couple hours at least.

RS And there uh continued to be negotiations and just no response?

LA Yeah definitely.

RS Okay.

LA There referred to the smoke and uh, you know we think the house could be on fire; yes it was on going negotiations.

RS Okay and pretty much up to the time where the trailer gets fully engulfed and there's still nothing,

LA Still no, there was no, no responses. By the time the, the, we could hear flames we couldn't tell whether, by the time we could see flames, we couldn't tell whether, by the time we could see flames, we couldn't tell whether what we were hearing was uh caused by the heat or fire or by some activity inside.

RS What were you hearing?

LA Uh just some um kind of bumping or shifting noises.

RS Okay. Did you hear any like rounds going off?

LA Yeah heard popping noises.

RS Okay.

LA Um some people thought it might have been um heated ammunition,

RS Okay.

LA I don't know.

RS Okay.

LA It could have just been fire noises as far as I'm concerned.

RS Okay. Did, and um, did you ever, you or someone else ever measure with the range finder from the tribal vehicle to the number four (4) side?

LA I think I heard somebody who did, I think they though it was around seventy (70) yards.

RS Okay. The ferrets that you guys used, they're powder and from, I believe what Jones told us, it goes in and if it hits something it kind of, I don't want to say explode but I guess somewhat and the powder goes in the air and falls down, is that correct?

LA That's what I understand.

RS Okay. And um you were just at training, the smoke grenade that's a tri, tri chamber okay?

LA Mm hmm.

RS Did you uh get any training with that at all?

LA Um a little bit I watched an instructor set one (1) off, and uh we, we walked through the you know cloud of smoke.

RS Okay.

LA Um they set off a lot of stuff at the training, I don't know if we're talking about exactly the same thing or not but.

RS It's, I, I from what I understand it's a pyrotechnic but it's contained inside of the canister?

LA That sounds,

RS Okay?

LA Yeah that sounds like a good description.

RS And does that mean that obviously pyrotechnic is something that shoots flame out or is it just heat?

LA Uh I don't remember anything that really shot uh, uh a flame out, it just, it, it omits a certain amount of heat as the reaction as it, it expels the material that's inside of it.

RS Okay and what about a uh, I think it's a sting ball?

LA Uh huh.

RS Okay did you have any training on any of those at all?

LA If it's the same thing I'm thinking of, what I'm thinking of, what I'm thinking of a sting ball is uh a round ball that has little tiny, it's like a little grenade that has little uh rubber balls

inside of it that are uh blasted out in a uh like a kind of a three hundred and sixty (360) degree direction.

RS Yes.

LA Uh yes we, we uh got to throw a few of those.

RS And they are, are, are those a pyrotechnic at all?

LA I didn't think so um,

RS Okay.

LA Um,

RS And the C.S., I believe it's called expulsion type of device, do you, do you know how that works?

LA I don't know that I could describe it to you, we, we, were, we sampled a large number of munitions um way more than probably I'll ever use in the department and the whole idea was to, give us an idea of what was out there um and then as we determined our needs here, you know we will practice with what we feel like we need,

RS Okay.

LA So I, I don't know that I can tell you, you know describe to you the what your referring to.

RS Did you guys take any pyrotechnic uh gas with you guys?

LA Uh we had some in, in, in our uh our go bag, yes.

RS Okay and what, what was that?

LA Um they were just uh what, I can go and get you the inventory sheet from the bag, but I can't remember the names of them right off.

RS Okay.

LA Of what we have, we have a few,

RS You guys never gave them to anyone or anything like that?

LA Did not, no.

RS Okay. Um did, when you were out there Louis um did you ever hear anything about pyrotechnic being mentioned or anything like that?

LA We, I did um I thought that the, I thought that they said that the hand held or at least some of the hand held ammunition that they were, they were gonna throw was uh um was a pyro type um (inaudible) and it was way late in the course of the you know they tried everything else that felt might be effective um so when they threw it I was under the impression that it was some kind of a pyro, later I heard that it may not have been what they used.

RS Okay so okay. And Louis when, when you were out there, did you hear any, did you ever see the chimney to the trailer?

LA Yes.

RS Did you ever see smoke coming out of that?

LA Yes.

RS When was that?

LA When was it, was uh I'd say probably the time I noticed the first was the second deployment of the hand held, when I said that the, the smoke would volume was much greater, I saw smoke, white smoke coming out at that point in time, there was a lot of smoke coming out uh the windows, some coming out the 'A' and 'B' and the number three (3) side, um that would have been the first time I saw any smoke coming out the chimney.

RS Okay. Did you hear anybody mention anything about the [REDACTED] inside starting a fire or anything?

LA No.

RS Louis why do you think I mean do you think, why do you think the gas wasn't effective in driving the [REDACTED] out of the residence?

LA Um I think he was either able to find a, a location inside the house where it was bearable, he found some means of protecting himself. Uh he had, there's some level of determination or, or craziness or,

RS Let me ask you this, if someone can barricade themselves in a room um, what ways to defeat the gas.

LA Well they can try to seal that room off from the rest of the, the um, the house that's been contaminated.

RS Okay.

LA If they can find an isolated position you know, I think they, they chose the best area that they can find and then they start sealing things up, they start sealing the cracks under, around the doors.

RS Does water effect chemical agents at all?

LA Um try to when we do the training um we're, we're required to carry water in our, in our cars in order to try to assist people that we have O.C.'d um it seems to help um at least people think it does. I kind of feel like it goes away, one (1) about the same rate whether you wash it or not.

RS Okay.

LA Um but definitely feels like it helps at least right when your putting it on.

RS Okay and were you guys ever asked to put gas on the number on (1) side?

LA No.

RS Okay do you know why gas was never introduced on the number one (1) side?

LA Uh I'd say because of the lack of approach.

RS Okay.

LA That, that was my assumption as to why we, we didn't go there uh it was, we were so far off on this side because of the uh exposure,

RS Right.

LA I don't, I just don't, that was, that was dropping off down hill on that side and there was nothing there so I just didn't think we, it was (inaudible),

RS I mean from the Yurok vehicle there was some bushes here then I believe it just opened up right into the number one (1) side?

LA Uh that's what I remember, I never uh got a real good look at what was on the number one (1) side, I never walked down on the lower side,

RS Okay.

LA But uh that was our big, the problem with the whole operation, one (1) of the big problems was the exposed setting.

RS Okay and let me ask you this, the rifleman, do they get full SWAT gear and everything?

LA Um no usually they don't, unless they get it themselves, uh they don't have you know the vests and you know.

RS What did, what did you have Louis?

LA I carry, I did have a vest on that I was carrying um that has the pouches for the uh Chemical Agents.

RS Okay.

LA Um otherwise I was just wearing uh regular, regular duty gear. Uh I carried my rifle on the initial um period of time when I was out on the perimeter with Sanchez um my rifle was back at the SWAT truck when we went out with the Chemical Agents.

RS Okay and what kind of rifle do you carry?

LA It was, it's just an AR fifteen (15).

RS Okay and you carry a Glock forty (40)?

LA Correct.

RS Um were you guys mainly receiving directions from obviously your Sergeant Nova and S.O.'s Lieutenant Cavinta?

LA Yeah.

RS Okay.

LA Our, our, our direction came from Nova.

RS Okay. Steve?

SD As far as you know, did uh any of the member of the Eureka Police Department SWAT Team fire their uh weapons?

LA No.

SD Um at one (1) point you said when you first arrived on scene you went with Officer Sanchez uh to an area it looks like on the number three (3) side, um and you went back to the Command Post and then were asked to deploy gas on the number two (2) side, then you were asked to deploy gas on the number three (3) side, what was the distance on the number three (3) side, I think you might have answered that but I think missed it?

LA Number three (3) side was a uh close to seventy (70) yards.

SD Was that further or about the same distance as the number two (2) side where you were trying to deploy?

LA It was uh slightly near,

SD Closer?

LA Closer.

SD Um also on the number two (2) side, you weren't sure if there were one (1) or two (2) windows but you were uh, you are sure that there was at least one (1) window cause that was your primary target?

LA Yes.

SD Um other than a thirty seven (37) millimeter gas rounds from Eureka Police Department are you sure that no other items were provided to the Sheriff's Department uh for them use or uh was there anything else other than the standard thirty seven (37) millimeter gas rounds that you guys had that were used, that you're aware of?

LA That's all that I know of.

SD It sounds like some uh the Sheriff's Department might have used some twelve (12) gauge ferret rounds to break a window out or something on the, on the number four (4) side?

LA Yes.

SD Did anybody from Eureka P.D. use any twelve (12) gauge rounds?

LA No.

SD It sounds like you have been to this gas school, but are you considered kind of "in training" at this point in time, in regards to the deployment of gas and working with the SWAT Team as a (inaudible)?

LA I con, I consider myself that uh as far as experience goes. I really think the, I went through that period of time, that training for uh the week but um I really think I need to practice on my own, experiment on my own, which is what we were trained to do.

RS Does, is the shotgun ferrets, are they pretty similar to the thirty seven (37) millimeter, ferrets obviously a much smaller size?

LA They appear similar yes.

RS Louis would you go ahead and sign this for me?

LA Mm hmm.

RS (Inaudible) sketch, and is there anything that uh Investigator Dunn and I have not asked you, that you think would be important for us to know?

LA I think you pretty much covered our roll.

RS Okay, and let me ask you this, is there anything, cause you guys were there quite a while,

LA Mm hmm.

RS And um is there anything else that you think could have been done to, to get him out of there or I, I mean obviously you have an active shooter, I, I, in your own opinion, what else could have been done?

LA Mm I don't know you know uh short of going away, out of his sight and seeing what he would do which is a, a risk, I don't know what you could do, I, I don't think that's an option once he's started shooting at people.

RS Okay. Alright we'll end the interview at zero six forty (0648) hours.

End of transcript.

Transcribed on 1/15/2008 by ■■■ 0608.

HUMBOLDT COUNTY SHERIFF'S DEPARTMENT

CASE: 200703162
INTERVIEWER: Rich Schlesiger, Detective
SUBJECT: Attempt PC 187/ Officer Involved Shooting
STATEMENT OF: Matthew Spallino, Tribal Police
DATE & TIME: June 3, 2007 @ 2133 hours.
LOCATION: Hoopa, California

ALSO PRESENT:

RS Rich Schlesiger
MS Matthew Spallino

RS Okay date is June third, (3rd), two thousand seven (2007), time is twenty one thirty three (2133) hours, and your full name?

MS Matthew Spallino.

RS What's your middle initial?

MS "F".

RS S-P?

MS A-L-L-I-N-O.

RS Twenty five zero (250)?

MS Four (4).

RS Okay and your employed by Tribal Police Department?

MS Yes.

RS Matt how long have you been working for the Tribal Police Department now?

MS Uh a year for Hoopa and a year and a half for the Yurok's before I came up.

RS Okay. Okay when did you start your shift?

MS I got called out at four (4) o'clock from McKinleyville.

RS Okay is that where you reside?

MS Yes.

RS Okay. So you get called out of your residence, do you have a patrol car there?

MS Yeah.

RS Okay and um so you get called out at four (4) o'clock.

MS Right around four (4).

RS Okay and you respond from there right?

MS Right.

RS Okay uh what, what are you told when about the call?

MS Uh I was told that [REDACTED] I don't know his last name.

RS [REDACTED]

MS [REDACTED] [REDACTED] was barricaded inside a residence, and was armed with a firearm.

RS Okay. Was there anything else said?

MS That was it.

RS Okay. Did you respond Code three (3)?

MS I responded Code two and a half (2 ½).

RS Okay. So do you recall Matt about what time you got here?

MS I, I'm not real sure.

RS Okay. When you get here and this is called Bald Hill Road right?

MS Right.

RS Okay and um when you get here where, where do you go to from there?

MS I was advised that it was, there would be two (2) white poles at the end of the driveway, marked with tape, so I responded and parked behind the patrol vehicles that were already on scene.

RS Okay. Do you remember who was on, on scene Matt?

MS Uh Will Hostler, Ed Guyer and lets see,

RS Nolan?

MS And CHP Nolan.

RS Okay. Miller?

MS Yes Miller, Miller was here.

RS Okay. Were those cars parked, parked in the driveway?

MS Yes.

RS Okay how far back were you in that line?

MS I parked right behind the, right behind Sergeant Miller's car.

RS So there would have been four (4) or so?

MS Yeah.

RS Okay. Did, did anybody else arrive?

MS Uh Deputy Taylor arrived shortly after I did.

RS Okay and um what are you told when you, when you arrive?

MS That, well I heard over the scanner that he had went out on the front porch, was waiving a gun around, when I arrived I was told that he had came to the back window once and was yelling something,

RS And, and Officer Berry and or Deputy, Deputy Berry and Officer Landreneaux were here right?

MS Right, they were pinned down on the other side of the

RS Okay.

MS Residence.

RS Okay. And when you get out of your vehicle are you armed at that time?

MS Yes.

RS What are you armed with?

MS My AR and my duty forty (40) Glock forty (40).

RS Okay. Which one (1) did you have either of them drawn?

MS I had the AR in my hand.

RS Okay. And where did you take up a position at?

MS I took a position behind uh Chief Hostler's vehicle.

RS And where was that in the line of vehicles?

MS It was the first (1st) vehicle.

RS Okay, were you passenger, drivers side?

MS I was at the back at first and then uh Sergeant Miller advised that after forty seven (47) arrived for forty seven (47) to take one (1) door, I took the other and

RS Taylor?

MS Cover, Taylor and we covered the rear windows.

RS Okay. So you were where at on, in

MS I was passenger side.

RS Okay. Okay.

MS On the front vehicle.

RS And are you pointing your weapon at the, your AR at the uh,

MS At the residence, yes.

RS Okay and do you see anything at the residence, do you hear anything or anything like that?

MS Nothing, nothing at first (1st).

RS Okay. How long does it go by until you finally hear something or see something?

MS Approximately probably twenty (20) minutes after being behind the door, I observed the [REDACTED] come to the window with a red shirt on.

RS Okay did you recognize that person?

MS Yes.

RS Who was that person?

MS It was [REDACTED].

RS [REDACTED] [REDACTED]

MS [REDACTED] [REDACTED] yes.

RS Have you had dealings with him before?

MS Yes we [REDACTED] approximately a week ago.

RS Okay. What was that encounter like?

MS Uh I was called out, Sergeant Guyer already had him detained before I got there but I was, the call was uh he had entered his parents, parents' residence and was mixing gas and something together.

RS Okay. Did you talk to him on this encounter at all?

MS I talked to him briefly when he was in the back of the car.

RS How was he acting?

MS Um he advised he was a uh Coyote zombie, had lasers in his head, people were trying to kill him.

RS Okay. [REDACTED]

MS Uh the ambulance arrived I, I followed the ambulance till Arcata, they advised he was Code four (4) and took him the rest of the way.

RS Okay. Okay now back to today, were, were, you guys were there and um how much time passes before anything goes on?

MS Uh approximately probably a half hour.

RS Half hour?

MS Yeah.

RS Okay and what happens?

MS He comes to the window, he,

RS (Inaudible) red shirt?

MS Right. See him come to the window in a red shirt he hocks a "luggie" out the window and he, trying to think of what he said. He said he was going to get his M sixteen (M16) and, I can't remember his actual (inaudible) uh his exact words, he said something about he was going to get his M sixteen (M16) cap all of us if we don't move out.

RS Okay. What happens then?

MS Uh he left the window

RS Okay.

MS Approximately five (5) minutes later Deputy Taylor and I were covering the windows, Taylor advises he has a gun, I observed the gun sticking out of the window, but I couldn't see him.

RS What, what did the gun look like?

MS It, I could just see a black barrel sticking out.

RS Okay. Okay. Was it pointing towards you, away from you guys?

MS It was pointing towards us.

RS Okay so he could visible see that law enforcement was there?

MS Yes.

RS Okay. And uh what happened then?

MS Um shortly after I saw the barrel, he fired two (2) shots, I took cover behind, behind my door on the ground.

RS You heard two (2) shots?

MS I heard two (2) shots.

RS Did you see

MS I heard two (2) shots and then I heard Deputy Taylor fire one (1) in return.

RS What was he armed with?

MS He I believe it's an AR.

RS Okay and um, did you see the gunfire at all?

MS I didn't.

RS No you just heard the two (2) shots?

MS I heard the first shot and immediately went for cover.

RS And you had noticed before the gun was pointing right at you guys?

MS Right.

RS Okay and you hit, you ducked down, what happens after that?

MS Um like I said I heard the second (2nd) shot and then I heard Deputy Taylor fire one (1) shot in return.

RS Okay.

MS And where I was at behind the door I couldn't, had no more visible or you know.

RS Did you retreat from that point or what did you guys do next?

MS Um we stayed behind cover, Deputy Taylor was covering the window at this, that time Deputy Lundie was on scene he was right behind me um I moved to the rear of the vehicle, staged there.

RS Okay and was there anything else coming from the house, did you guys yell anything towards the house, anything else go on?

MS I don't recall if,

RS Okay did you ever see movement at the house after that at all?

MS No Deputy Taylor advised he shot the window and like I said where I was at I had no (inaudible).

RS That he, he shot the window or [REDACTED] shot the window?

MS That [REDACTED] shot the window after he had fired.

RS Okay.

MS [REDACTED] shot the window and then retreated back inside.

RS so you guys stood by there until you were relieved?

MS Right.

RS How long would you say you stood by?

MS I was approximately ten (10) minutes.

RS Okay.

MS Like I said, Deputy Lundie was at the rear of the vehicle with me and then that other SET Team guys arrived and they relieved me.

RS So how long was that?

MS I'm thinking approximately ten (10) minutes.

RS Oh okay so that quick.

MS Yeah.

RS Cause you came from McKinleyville?

MS Right.

RS So it was a longer drive. Okay I see. Um were you in a marked patrol unit?

MS Yes.

RS Okay and are you dressed like you are in full uniform right now?

MS Yes I am.

RS Okay. And did I ask you if you shot?

MS No you didn't but no I never fired.

RS Okay as far as you know you heard, did you see Deputy Taylor fire his shot?

MS No I heard the shot and he advised over the radio that he had returned fire.

RS Okay. Okay. Okay Matt is there anything else about the incident that, that I haven't asked you, you think would be important for me to know?

MS Um well the second part when the bullet went whizzing past us.

RS Well right that I should, that wasn't the only shots that have been fired.

MS Right.

RS And it happened, I don't, I don't recall what time I got here but when I was up here talking to some people I hear shots and then when we were down there talking he shot towards us.

MS Right.

RS Or ricochet or whatever happened.

MS Right.

RS Um so as far as you know, three (3) total shots fired, the first incident that you were there for?

MS The first incident.

RS Okay.

MS Although there were two (2) bullet holes in my window shield and one (1) in the windshield of the vehicle behind me so.

RS Okay. So

MS And there could have been three (3) like I say I mean I was just reacting you know.

RS There was two (2) in yours?

MS There, there's two (2) bullet holes in the front passenger,

RS Okay.

MS Of Will Hostler's vehicle, which I was behind the door.

RS And his was the first vehicle?

MS His is the front vehicle and then there's one (1) bullet hole in the vehicle right behind me, Sergeant Guyer's.

RS Okay and that was in the windshield?

MS And that's in the windshield as well.

RS Okay. Alright anything else Matt?

MS No I think that's,

RS Okay we'll end the interview at twenty one forty (2140).

End of transcript.

Transcribed on 1/2/2008 by [REDACTED] 0608.

HUMBOLDT COUNTY SHERIFF'S DEPARTMENT

CASE: 200703162
INTERVIEWER: Rich Schlesiger, Detective
SUBJECT: Attempt PC 187/ Officer Involved Shooting
STATEMENT OF: Mike Nolan, CHP.
DATE & TIME: June 3, 2007 @ 2208 hours.
LOCATION: Hoopa, California

ALSO PRESENT:

RS Rich Schlesiger
MN Mike Nolan.

RS Okay date is June third (3rd), two thousand seven (2007), time is twenty two zero eight (2208) hours. Mike what's your middle initial.

MN (Inaudible).

RS And your badge?

MN Eleven three ten (11310).

RS And you're a Highway Patrol man?

MN Yes.

RS How many years?

MN Twenty three (23),

RS Okay.

MN Or so.

RS Okay and were you working today?

MN Yes.

RS Okay and what was your shift?

MN Um fourteen hundred (1400) to twenty two thirty (2230).

RS Okay. And um how did you end up here on Bald Hill Road?

MN Dispatch gave me a call to assist the sheriff's department with a person at a house pointing a gun out at them.

RS Okay.

MN At about, it was about three thirty (330) or so.

RS Okay. And where did you respond from?

MN Um my house.

RS Okay and um do you remember recall what time you got here about?

MN Uh no I didn't look at it.

RS Okay and when you got here um who else was on scene when you arrived?

MN It was uh Ed Guyer, well on the way up here, I saw the Yurok officer's going down the hill, they didn't know where this location was, so they followed me up and I don't know their names.

RS Okay.

MN Um it was Ed Guyer, Willie Hostler and the other Hoopa Officer which,

RS Spallino?

MN I think it's Spallino, Spallino.

RS Yeah.

MN They were the one's on the driveway, they were the one's that I saw.

RS Okay.

MN And then I saw Mike Roberts later when I went up to the cross.

RS Okay. When you guys go down the driveway, um where were you parked at?

MN I was, I was directly behind the tribal officers, the two (2) SUV's.

RS Mm hmm.

MN And then um Yurok was down there and they were sent up to the cross but didn't know where it was, so I went up and showed them where it was and then I came back down.

RS Okay.

MN Cause my car was dragging rocks up there.

RS Okay. So when you come back down who's there then?

MN Hostler, Guyer, and Spallino.

RS Okay was Taylor on scene yet?

MN No.

RS Okay, um when you got out of your vehicle, what did you do then?

MN I um watched the, I guess they call it the south side of the house, which would be the back of the house, the trailer, and was on the drivers side of the second (2nd), the furthest back unit, just maintaining a perimeter.

RS So

MN (Inaudible) cover.

RS There's tribal, tribal then you?

MN There was a tribal SUV a newer one (1) and then uh the tribal SUV behind it and then when I parked, I parked up the embankment to allow cars to get around me if they needed, so my car was about twenty five (25) feet back or so against the embankment. I went up to the, the first tribal unit I came to and I stayed pretty much on the drivers side wedge of the door.

RS Okay and did you have any of your weapons' drawn?

MN I had the, the handgun was in the holster, and the um the AR was on my hip in the wedge of the door.

RS Okay. And um any uh from, from the house did you hear anything, did you guys yell anything towards the house, anything like that go on?

MN No not that I recall no. I saw um I heard some yelling from the house, we didn't say anything back.

RS What was the yelling?

MN I don't recall exactly what was said it was just yelling.

RS Okay. And uh what happened after that?

MN Um saw a guy in a, with a red on, look like red uh something on his head.

RS Did you recognize the guy at all?

MN No I don't know him.

RS Okay.

MN And then all um I didn't see what was pointed, it was, he was, like had something hanging out the window and all of a sudden you heard popping sounds.

RS Okay. Did you see a gun hanging out of the window?

MN I didn't see the gun no.

RS Okay. You saw something hanging out?

MN I saw him with his, his hands out the window, I didn't see what it was.

RS Okay. And uh how many popping sounds did you hear?

MN I heard it was either three (3) or four (4).

RS Okay. And what did you do when you heard those sounds?

MN I ducked.

RS Okay and after that what happened?

MN After I could smell uh, I could actually smell a smell and something, small little particles came over the, the wedge of the door, I remember little particle things

RS Okay.

MN And then I popped my head up a couple of times and by then the guy had left the window.

RS Okay. Did you notice anything about the vehicles, the patrol units?

MN I noticed uh after the fact that the, the one (1) I was standing next to had a hole in the window.

RS Okay. Did any of the other vehicles have any holes in them?

MN I didn't go up there.

RS Okay. Did you, did you guys retreat back or did you stay at that position you were at?

MN I went around to the back of the SUV to the passenger side, um the officer I was with the Tribal Officer Guyer um hurt his knee so he sort of hunched down on the drivers side back of the and I was on the passenger side.

RS Okay.

MN At the back of the SUV.

RS And you just stayed posted there until you were relieved?

MN I stayed posted there until yeah the um SWAT guys came.

RS How, how long was that Mike?

MN Time frame, it wasn't very long um Taylor had, was already there, Taylor was the first one (1) there and then a bunch of the other were in the back. I don't know any of their names, so I just know once, once

RS So the SWAT guys show up,

MN The shooting (inaudible) over with, they started coming up and they lined up on the left side of the cars,

RS Okay.

MN And then I went back to the, further back.

RS Okay, um and were you in a marked patrol car?

MN Yeah.

RS And are you dressed in full uniform like you are right now?

MN Yes.

RS Okay. Mike is there anything about that incident that I haven't asked you that would be important for me to know?

MN Just that before the actual shooting took effect, Taylor had worked his way up into a position where he was up at the front vehicle on the drivers side and Spallino was on the passenger side and Willie had gone back to brief the uh command personnel from the Sheriff's department so,

RS Okay.

MN A couple of little changes of personnel had taken effect.

RS Okay. And obviously you've been here for a while and so have I but there's been other rounds that have been shot that you've heard?

MN Yes.

RS Okay. I believe on at least two (2) different occasions?

MN Um the initial one (1) and then the one (1) that, there was a volley just before nine (9) o'clock, I'm not aware of any others.

RS Okay.

MN And I was not, I was back with the command personnel at that point.

RS Okay. Anything else Mike?

MN No that should do it.

RS Okay we'll end the interview at twenty two fifteen (2215).

End of transcript.

Transcribed on 1/4/08 by [REDACTED] 0608.

HUMBOLDT COUNTY SHERIFF'S DEPARTMENT

CASE: 200703162
INTERVIEWER: Rich Schlesiger, Detective
SUBJECT: Attempt PC 187/ Officer Involved Shooting
STATEMENT OF: Mike A. Fridley, Sergeant
DATE & TIME: June 27th, 2007 @ 1414hours.
LOCATION: C.I.D. Humboldt County Sheriff's Office, Eureka, Ca.

ALSO PRESENT:

RS Rich Schlesiger
MK Mike Fridley

RS Okay date is June twenty seventh, two thousand and seven (6272007). Time is fourteen, fourteen (1414) hours. Case is two zero, zero, seven, zero three one six two (200703162). Sergeant Mike, what's your middle initial Mike?

MF "A".

RS Fridley, F-R-I-D-L-E-Y. Pin?

MF Zero eight three seven (0837).

RS Okay and we're in my office in C.I.D. um we just saw each other Mike and um Dunn had told me something, Investigator Dunn told me something that he talked to you over the phone and you mentioned something about seeing the transaction between C.D.C. and the S.O. guys, of, of the chemical agents.

MF Yes.

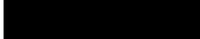
RS And just to go back, you, you were an negotiator for the, the stand off with 

MF Yes.

RS And that was the third (3rd) and fourth (4th) of June?

MF Yes.

RS Okay um how, how far away were, were you negotiating when or attempting to negotiate I should say when uh the transaction went on between the C.D.C. guys and the S.O. guys?

MF What was going on is I was using the second (2nd) tribal unit, not the first one (1) up the road but the second (2nd) one (1) back, I was using the P.A. to do my negotiations um at the point where the transaction went, went down, I stopped and talked to them cause they would have been standing right in front of the speaker and they wouldn't be able to hear anything so,

RS Oh okay.

MF That's kind of why I was there when they were doing all that, I was getting ready to get back on the radio or on the P.A.

RS Okay and what did you see occur when, when they met with one (1) another and who, who was there?

MF I'm not sure I remember everybody but there was uh Sergeant Bryan Quenell, Deputy uh Jaime Barney, uh lets see Deputy Blake Massaro, Deputy Jesse Taylor and I think Deputy Brian Taylor was there but I can't remember, I'm not sure about that.

RS Okay and there was some C.D.C. guys there too; I think we called in for some assistance from them from their tactical team?

MF Yes.

RS Um and did you hear a conversation about the deployment of gas?

MF Yes.

RS What was that?

MF Um one (1) of the C.D.C. officers, I don't know his name um he brought a vest up to where we were at between the two (2) vehicles,

RS What did the vest look like?

MF I believe it was black, like a black nylon type vest.

RS Okay.

MF It had a lot of pockets in it and in those pockets were the different types of uh chemical munitions I guess you'd call them.

RS And what did he look like?

MF Um he was probably about five three (5'3") thin build, kind of muscular with a thick mustache

RS Okay and who was he talking to?

MF Um he was talking to Sergeant Quenell and I believe Deputy Barney was the chemical guy so he was talking to mainly those,

RS Okay

MF Two (2) but everybody else was there in the area listening.

RS Okay and what was their conversation?

MF Um they were talking about we had introduced ferret rounds into the, the building and there was a conversation about using um some munitions with smoke in it so with the you know the psychological factor of the smoke canister cause I guess the ferret rounds don't have a colored smoke in them, so they start to talk about that and I think that's where C.D.C. ended up bringing up their stuff up that they had and they, they offered to let us use some of their munitions.

RS Okay and do you see an exchange of munitions or, or not?

MF I didn't see the exchange, I saw the C.D.C officer that I described pull out several different types of weapon, I don't know what they're called canisters I guess,

RS Munitions yeah canisters.

MF And he explained that some of them were pyrotechnic and I took that to mean that they burned and some of them weren't um he explained how they were used, there was a lot of concern by Sergeant Quenell and I believe with the C.D.C. person that we didn't want to use anything that was gonna possibly start a fire so that's where the conversation was about those.

RS Okay and um is that when the guys went and after that they went up towards the house,

MF Yes.

RS And did one (1) deployment?

MF Yes.

RS Then they came back and was there another conversation at that time?

MF That I don't remember, (inaudible) other than they had uh, C.D.C. brought this big ballistic blanket thing too and that's what they used to go up to the house with.

RS Okay. Did, when they were down there talking Mike was there any conversation about uh a stinger ball or a handball or anything like that?

MF Yes. Um I remember the, the C.D.C. Officer took out a, a, it looked like a grenade to me more than anything it was round black and he explained that, that uh this was, they called it a yard ball I think was the term he used or yard buster or something like that and he said that,

RS Mm hmm.

MF And he said that it, when it went off it exploded and there were rubber, not bullets I don't think he said bee bee's or pellets or something like that and that it, I'm pretty sure he said it also had smoke in it also on top of that with either C.N. or C.S.

RS Okay.

MF And uh they thought maybe that would be a good choice too, the psychological factor.

RS Did uh they ever say the name of that munition itself that you recall?

MF Yard ball, Yard buster, that's all I remember.

RS Okay.

MF Something to that extent.

RS And you said it was round and black?

MF Yeah.

RS Did you see any writing on it or anything like that?

MF No.

RS Okay. Um what, did you also see some canisters that were provided to Barney or Quenell?

MF Yes.

RS Do you know how many?

MF No I don't.

RS Okay. When they went up the second (2nd) time, did you hear anything when, when the munitions were deployed?

MF No I didn't.

RS Okay. You ever been a gas guy or anything like that Mike?

MF Yeah in the army I was a nuclear biological chemical specialist.

RS So you know the difference between pyrotechnic and non pyrotechnic?

MF I didn't really learn that in the service but yeah there's some of them burn and actually cause fires and other ones and more safe in that type of aspect.

RS Would uh this is just getting off the thing just seeing what your experience is with it. Is there pyrotechnic that are actually enclosed in like a canister, it can still be considered a pyrotechnic but safe for indoor?

MF That I don't know.

RS Okay. I'll show you some pictures Mike, I've got them labeled there a little bit out of order because I've been showing someone else them, number one (1) is a picture of a vest, do you recognize that?

MF Yes, that's the black vest I described.

RS Okay and number two (2) is a picture of a canister a speed heat?

MF I don't, I didn't see the writing on the canisters but that's what the ones' looked like that I saw the um Pelican Bay Officer giving to our team, they were silver and (inaudible) and like that but I didn't see the words on them.

RS And then on number one (1) here, no not number one (1), lets see if I can find it. On number two (2) you see on your right hand side a hand and a ball?

MF Yeah it's kind of blurry but yeah.

RS Does that thing look like anything that you saw?

MF Yeah I can't see the top of it but it was that shape, it was, it looked like it was made out of maybe hard rubber plastic or something like that.

RS Do you remember the writing on it at all?

MF No I didn't see that.

RS And skipping to number four (4) here's a blown up picture of it.

MF That's what it looked like the thing he described as a, a yard ball.

RS Okay. And uh here's another picture I think that's one (1) of the tribal vehicles that were in front and then there was vest placed in back of it.

MF Yes. I believe this the, the first (1st) vehicle up cause I used the second (2nd) one (1) and I don't remember seeing these boxes in there unless they got put in there later.

RS Okay and showing you number five (5) and number six (6), there's a stinger ball and a handball, do either of those look familiar to you?

MF Um it could be either one (1) of them, they both have the same shape of what I saw um and these are kind of poor pictures, there, (inaudible) look like they're digital or something but,

RS There off the computer I think.

MF Um that's what they look like but I could tell you if it was one (1) or the other, no I couldn't do that.

RS Okay. Mike is there anything that I haven't asked you that you can remember that would be important for me to know about that exchange or anything like that?

MF Um I remember he wanted to give Deputy Barney that whole vest, and I'm pretty sure they just took the munitions out of it and left the vest cause they didn't want it. I remember they didn't, I remember Sergeant Quenell and Deputy Barney talking about not wanting to, to confuse any of the, the munitions.

RS And did you see the actual hand over of the munitions to, with it Bryan or Barney?

MF No I didn't see that.

RS Okay.

MF Must have stepped away from there at that but I, I was standing by the, the door of the, driver door of the second (2nd) tribal unit and those guys were kind of hunkered down in between the hood front of that vehicle and the rear of the other one (1) so.

RS Okay.

MF I was kind of paying attention but I wasn't really like really intent on what they were talking about, it was interesting to me that's why I listening.

RS Okay, all right, I can't think of anything else, can you?

MF No sir.

RS Okay we'll end the interview at fourteen twenty five (1425) hours.

End of transcript.

Transcribed on 1/18/08 by [REDACTED] 0608.



HUMBOLDT COUNTY DISTRICT ATTORNEY'S OFFICE INVESTIGATION REPORT

DATE: July 17, 2007
CASE: HCSO #200703162

Witness: Mike Roberts, Hoopa Valley Tribal Police Department

DA Investigator: William Honsal

On June 8th, 2007 at 1015 hours, I interviewed Hoopa Valley Tribal Police Officer Mike Roberts, regarding HCSO case # 200703162. The interview was recorded on cassette and the following is a summary of her statement. For a detailed statement refer to attached transcript of the interview.

Mike Roberts has been working as a school resource Officer for the Hoopa School District. He has been working off and on as a police officer since 1981. He has a total of 10 years of law enforcement experience. The following is a summary of his account to the incident on Bloody Camp Road.

On June 3rd, 2007, at 1600 hours, Roberts responded to [REDACTED] Road/Bloody Camp road in regards to a [REDACTED] call. When he arrived on scene he was initially used as scene security. He walked the perimeter and cleared bystanders back to a safe distance. He then took a position on the Northeast side of the residence to contain the scene. Soon after he took a position on the Northeast side he observed [REDACTED] walking away from the residence towards [REDACTED] residence.

Roberts recalled just prior to the second shooting he was positioned on the #2/#3 side and used binoculars to check the residence. He described the time as being "Dusk." He observed [REDACTED] through the North window of the residence. [REDACTED] was wearing a red headband and walked in front of the window with what appeared to be a rifle. Roberts had several prior contacts with [REDACTED] and recognized him inside the residence. He observed [REDACTED] place what was believed to be a rifle against the wall of the room. He then started to fold clothes inside the room. Roberts observed him in the room for a couple of minutes then [REDACTED] left the room. Shortly after he left the room, he heard an officer state on the radio that the [REDACTED] was at the window with a weapon. Roberts then heard shots being fired. Roberts never observed any further movement through the North window. Roberts did describe hearing a voice from inside the residence yell, "Fuck," several times throughout the incident. He also heard what he described as a "War Cry" coming from inside.

Roberts was relieved from his position at approximately 2345 hours by HCSO SWAT personnel.

Roberts had never fired his weapon or observed anyone who had fired their weapon at the scene.

Refer to the attached report from officer Roberts for details.

Disposition: Supplemental report referred to HCSO.

June 4, 2007

Supplemental Report

Re: [REDACTED] [REDACTED]

On Sunday June 3, 2007 at about 1042 hours, I was dispatched to [REDACTED] residence to complete a [REDACTED] son, [REDACTED]. I arrived at 1108 hours after having difficulty in locating the residence, and for being delayed by a basketball tournament staff member (Hoopa recreation Co-Director [REDACTED]) who believed an illegal narcotics transaction might take place inside the neighborhood facility where I was at the time of the call.

I contacted [REDACTED] by cell phone and she directed me to her residence. [REDACTED] then reported the following to me:

On Friday June 1, 2007 her son, [REDACTED], arrived at her residence unannounced from [REDACTED] Eureka. [REDACTED] was unaware that her son had been released from the facility, and learned that a "facility security officer" had driven [REDACTED] to her residence and left him there.

On this day, June,3 2007, her other son, [REDACTED] had dropped his brother [REDACTED] off at her residence earlier in the morning. [REDACTED] told his mom that he could not "handle" his brother. [REDACTED] reported that his wetsuit and other items in his home were destroyed by [REDACTED] last night.

[REDACTED] then reported that [REDACTED] was seeing and talking to an imaginary squirrel and to himself after he had arrived. [REDACTED] told [REDACTED] that he had a dream that he killed his mother's four year old baby. [REDACTED] reported that the dream was about two weeks ago. [REDACTED] was frightened for her safety and for her family's safety. [REDACTED] told me you don't know what [REDACTED] is going to do! He needs help. [REDACTED] believed that [REDACTED] had returned to [REDACTED] since his recent release from [REDACTED] on Friday.

I told [REDACTED] I would try and locate him. She told me to check at [REDACTED] home on Little Moon Lane. I went to the [REDACTED] residence and spoke to [REDACTED] and an unknown male. They told me [REDACTED] had just left in a [REDACTED] car. I had past a [REDACTED] car being driven by [REDACTED] as I turned west onto Little Moon Lane from State Route 96. When questioned, both told me [REDACTED] was talking to himself and an imaginary animal/person. I asked them if they knew if he was using any drugs and they reported that they didn't know. Only that he was acting strange.

I drove downtown Hoopa and located [REDACTED] at Ray's Food Place. [REDACTED] reported that she did not drop [REDACTED] off at the store or that she had even seen him. I looked for Mr. [REDACTED] during the remainder of my shift. After arresting a [REDACTED] I just started my transport when dispatch reported that [REDACTED] was requesting an officer. I told my dispatcher that the sheriff's department needed to take the call because I

was transporting a prisoner to the jail. [REDACTED] had reported that Mr. [REDACTED] was at her residence.

Officer Mike Roberts

Mike Roberts

INTERVIEW WITH MIKE ROBERTS

Q=William Honsal

A= Mike Roberts

1
2
3
4
5
6
7
8
9
10
11
12
13
14
15
16
17
18
19
20
21
22
23
24
25
26
27
28
29
30
31
32
33
34
35
36
37
38
39
40
41
42
43
44

- Q: Record.
- A: R-O-B-E-R-T-S.
- Q: Okay. And how are you employed right now (Michael) Mike.
- A: I'm employed as a, uh, police officer with the (Hoopla) Tribal Police Department.
- Q: And how long have you been a police officer here?
- A: Uh, since December I believe I came over the resource position.
- Q: Okay. And, uh, how long you been a police officer?
- A: Uh, off and on since '81.
- Q: Eighty-one. How many total years experience do you think you have as a – as a law enforcement officer?
- A: Uh, ten.
- Q: Okay. Uh, were you working the night of, uh, June 3rd?
- A: Yes.
- Q: (Unintelligible). Okay. Were you dispatched to call off of, uh, (Bloody Camp) Road?
- A: Yeah.
- Q: Okay. Can you tell us about that call?

- 45 A: Yes. It – it originally came in that, uh, um, medical evaluate for a 5150
46 possible [REDACTED]
47
- 48 Q: Mm-hm.
49
- 50 A: And it turned into where the – a man pointed a weapon at a – at a deputy.
51 And I had just, uh, left the correctional facility in Eureka and then was asked
52 to respond code three to, um, the scene. Once at the scene I was positioned at
53 the northeast corner of the, uh, residence that the [REDACTED] was in.
54
- 55 Q: Okay. So once you – what time do you arrive on scene do you think?
56
- 57 A: I would...
58
- 59 Q: Estimating.
60
- 61 A: Estimating between 1600 and, uh, 1630 hours.
62
- 63 Q: On June 3rd?
64
- 65 A: On June 3rd.
66
- 67 Q: Okay. And, uh, once you got there who did you talk to? Who gave you that
68 information as far as...
69
- 70 A: Uh, I believe it was Chief (Unintelligible) and if he wasn't him then it was
71 Sergeant (Gyer) that put me in that position. They first asked me to, uh, clear
72 the citizens that were at the cross which is located to the east of the home on
73 the hill.
74
- 75 Q: Okay. And, uh, what I'm gonna present in front of you is a map okay? It's a
76 generic not to scale map but it kind of shows (Jasper Hospital) Road and
77 them, um, and then, uh, the residence how it was labeled and the scene as far
78 as the sides go one, two, three and four. Uh, the front door would be on the
79 number one side.
80
- 81 A: Okay.
82
- 83 Q: And we've indicated to be up on this and it might be a little more this way
84 but...
85
- 86 A: Correct.
7

88 Q: ...we'll just make due with the map here. So you got there and you were
89 deployed. You cleared people off the cross which is on the north side – the
90 east side...
91
92 A: Northeast side.
93
94 Q: ...of, um, of the residence okay? And can you mark on this map where you
95 initially were employ- or deployed?
96
97 A: Um, I was at a position that – where the number two and three side meet at the
98 right angle.
99
100 Q: Okay. Can you put that as a number one?
101
102 A: Right there?
103
104 Q: Right there where you positioned.
105
106 A: Okay.
107
108 Q: Okay. And, uh, what was your job at that point?
109
110 A: At that point it was just to, um, hold the perimeter but I was uncertain about
111 where Deputy (Barry) was and I had saw foot traffic or heard noise on the
112 road that led from the north side of the trailer back to Mr. [REDACTED] who's a
113 93 year old gentleman to the north of the residence. So I left the number one
114 position and went to the fence line and cross over and saw this man that I
115 knew as I believe his last name is [REDACTED] but his first's name [REDACTED] who's
116 the owner of this (unintelligible)...
117
118 Q: You saw [REDACTED])...
119
120 A: Yeah walking...
121
122 Q: ...walking away. Okay.
123
124 A: Um, then I went back to the number one position.
125
126 Q: Okay. Did – did – do you say anything to [REDACTED]) at that point?
127
128 A: No. Nope.
129
130 Q: You had saw it was him and then...
131
132 A: Yeah. Walking away from the scene.

133
134 Q: Okay. And, uh, was () carrying anything?
135
136 A: No.
137
138 Q: Okay. So you went back to number one. What was your job – you said this
139 was perimeter containment on the number two, three side?
140
141 A: Correct.
142
143 Q: Okay. Do you see anything from the inside?
144
145 A: Uh, later in the evening, um, I had borrowed some binoculars from, uh, a
146 (Unintelligible) Tribal Police Officer.
147
148 Q: Okay.
149
150 A: And during that time, um, I had see- observed, uh, Mr. () cross in front
151 of the window and wave the rifle on the north wall on the west side of the
152 window pane.
153
154 Q: Okay.
155
156 A: And then I observed him...
157
158 Q: Okay. Just st- I'm gonna stop you right there for a second. What time was
159 that? You said sometime in the evening.
160
161 A: Yeah.
162
163 Q: Do you remember what time?
164
165 A: It was just prior to – if I recall correctly just prior to the second shooting.
166
167 Q: Just prior to the second shooting.
168
169 A: Yeah.
170
171 Q: You saw, you know, do you have any prior contacts with () Have you
172 met him before?
173
174 A: Well I knew him when he was a young man.
175
176 Q: Young man.
177

178 A: But I hadn't, uh, dealt with him since I came back to (unintelligible).
179
180 Q: So how did you know that that was () that was inside the window?
181
182 A: Well because, uh, the call was for him and Deputy (Barry), um, said that he
183 was the one that, uh, was in the (unintelligible) that pointed the rifle.
184
185 Q: So was there any other person other than () in there?
186
187 A: Uh, not to my knowledge.
188
189 Q: Okay.
190
191 A: And they described him with a – I believe someone earlier in the evening said
192 he had a red headband.
193
194 Q: Okay. Did the person in the – that you saw on the number two side have a
195 headband?
196
197 A: Yeah he had the red headband.
198
199 Q: Okay. So you were looking through him at, uh, inside the window. Um, and,
200 uh, can you – can you draw on this map where – what window you were
201 looking at him through?
202
203 A: It would be this window right here.
204
205 Q: Okay.
206
207 A: On the north side. There was only one window.
208
209 Q: Okay.
210
211 A: And to the west of the window as you looked in it appeared to be like there
212 was, uh, bunk bed with, uh, white cover and that would've been positioned
213 right there.
214
215 Q: Okay.
216
217 A: And the (unintelligible) window (unintelligible) bunk bed or bed and it had a
218 white cover on. Uh, Mr. () crossed over and laid the rifle right here on
219 this wall. And then he folded clothes because when, uh, I saw him folding
220 something and it appeared to clothes and, um, and it looked like he bent over
221 on the floor and then like he had put on a little backpack of some sort. But I

222 wasn't certain. I didn't see a backpack just the motion of him. It reminded
223 me of somebody slipping something through their arm and onto their back.

224
225 Q: Okay so what was the, uh, was it dark outside? Was it getting dark at that
226 time?

227
228 A: Uh, it was du- it was...

229
230 Q: Dusk?

231
232 A: Yeah. It wasn't dark (unintelligible).

233
234 Q: Was - was there a light on in the room...

235
236 A: Yes.

237
238 Q: ...when he was doing this?

239
240 A: A little lamp.

241
242 Q: Okay. And then were there any window coverings over that window?

243
244 A: No.

245
246 Q: So you could clearly see inside?

247
248 A: Correct.

249
250 Q: Was a [REDACTED] with a bandana. Could you describe that he - that he...

251
252 A: Uh, it just happened so quick, um, it just went right in front and I - I don't
253 know what kind of...

254
255 Q: Could you describe it as a handgun, a rifle, um, what kind of gun?

256
257 A: I believed it was the rifle.

258
259 Q: It was the rifle.

260
261 A: Yeah. I didn't see a sling or anything.

262
263 Q: Okay.

264
265 A: I just saw the hand motion quickly cross in front of the window and put
266 something on the wall. Like he was standing something on the wall.

267
268 Q: So you saw what appeared to be a barrel...
269
270 A: Um...
271
272 Q: ...um, of a rifle?
273
274 A: ...I saw the hand on something so I assumed that it was the rifle that he had in
275 his possession.
276
277 Q: Okay. Um, so – but you don't really know for sure it was a rifle? You just –
278 you never saw...
279
280 A: I believed it to be yeah.
281
282 Q: ...him carry the rifle? You believed it to be?
283
284 A: But I didn't see the rifle itself. Just the hand motion and arm about how you
285 set a rifle down 'cause I've set rifles down walls before.
286
287 Q: Right.
288
289 A: It re- it presented to me that that was the rifle.
290
291 Q: Okay. Did you see him in the room with the rifle in the (unintelligible)
292 position or anything like that?
293
294 A: No. No nothing like that.
295
296 Q: (Unintelligible). Just you saw him kind of crossing the window and then put,
297 uh, an object...
298
299 A: Correct.
300
301 Q: ...believed to be a rifle against the wall.
302
303 A: What I believed it to be yeah.
304
305 Q: And you saw the red bandana on...
306
307 A: Right.
308
309 Q: ...and he was, um, folding clothes inside?
310

- 311 A: It looked like he was folding clothes and he'd put them on the – he covered
312 the white, uh, sheet up 'cause when he left I could see a dark color item on top
313 of the white – where the white bunk bed or sheet was.
314
- 315 Q: Okay. I'm gonna stop the tape for a second. Starting the tape back again.
316 Um, okay at that point, um, what happened? What happened next? You saw
317 him put the rifle and you saw then his hand folding clothes and then what
318 happened?
319
- 320 A: And then, uh, I didn't see him anymore.
321
- 322 Q: Did he leave the room? Did you...
323
- 324 A: I couldn't tell. He could've been on this side where – out of view of the
325 window.
326
- 327 Q: And, uh, you said you were using binoculars at that time.
328
- 329 A: Yes.
330
- 331 Q: Okay. So he just went out of view. Was the light – did the light stay on in
332 that room?
333
- 334 A: I think the light stayed on for a little while in the room...
335
- 336 Q: Okay.
337
- 338 A: ...and then if I recall right he turned it off later. But, um, between the time
339 when I last – when I last saw him and then the second round of shots occurred
340 I – if I'm not mistaken it was a short amount of time.
341
- 342 Q: Okay. So, um, so you saw him in this room just prior to the second shooting?
343
- 344 A: I believe that's when it was yeah.
345
- 346 Q: Okay. And so can you describe the events that – that took place in that second
347 shooting? What did you see? What did you hear?
348
- 349 A: Um, I didn't see anything but I remember hearing someone say that he was at
350 the window and they – I believe they chronologically on the radio went
351 through at the window pointing the weapon and then I heard shots fired. And
352 then I heard some more shots fired and I'm not sure if that was – I'm
353 assuming it was return fire but not certain.
354

355 Q: Okay. So you heard on the radio that the [REDACTED] at the window. Did they
356 tell you what window he was at?

357
358 A: Um, I don't recall.

359
360 Q: Okay. Is that the window - you were lookin' at your window and you didn't
361 see him in your windows?

362
363 A: Correct.

364
365 Q: Okay. And then, um, you heard that over the radio that he had a gun. And
366 then just after that you heard an exchange of gunfire.

367
368 A: Right. At the window that he was pointing the weapon and the gunfire.

369
370 Q: Did you hear anyone talking to him? Did you hear negotiations?

371
372 A: Throughout yeah.

373
374 Q: At that time? At that particular time?

375
376 A: Um, (unintelligible)...

377
378 Q: When the gunfire was being exchanged? Okay. And, um...

379
380 A: After - after - during that round of fire there must have been a ricochet that
381 went east because you could hear the ground go through the grass - the tall
382 grass - the whistling sound. X 8A

383
384 Q: Mm-hm.

385
386 A: And then you heard the gun sound.

387
388 Q: The gunshot.

389
390 A: And, uh, so I asked, uh, the two (Eurock) Tribal Officers who were to my
391 south if they were okay.

392
393 Q: Oh good.

394
395 A: 'Cause they didn't have any radio communication and they were both
396 (unintelligible). But they both heard what I heard.

397
398 Q: Heard that same thing?

399

400 A: Yeah.
401
402 Q: Okay.
403
404 A: And that was 2406 I believe (Thorne) and I'm not sure his last name and then
405 2408 and I don't know his name.
406
407 Q: Okay. And those are your (Eurock)?
408
409 A: (Eurock).
410
411 Q: Okay. Um, after the exchange of gunfire did you hear or see any movement
412 from the inside?
413
414 A: I believe he later came back and turned that bedroom light off.
415
416 Q: So you were still on the number three – number two side and, uh, when you
417 say later can you estimate the time?
418
419 A: I'd be really speculating that.
420
421 Q: Okay. That's – how long did you stay in that position?
422
423 A: Um, I think I was relieved around 2345 hours maybe.
424
425 Q: Okay. Um, so, um...
426
427 A: We held it for awhile and then the SWAT team took up a closer perimeter.
428
429 Q: Okay. And that time once the SWAT team arrived then you...
430
431 A: No we stayed for awhile after they arrived and then...
432
433 Q: Okay.
434
435 A: And later on we were relieved.
436
437 Q: So at 2305 then...
438
439 A: Twenty-three, forty-five maybe.
440
441 Q: Forty-five okay.
442
443 A: 'Cause I got off duty at 0030.
444

- 445 Q: Okay.
446
- 447 A: So by the time you drive down the hill and...
448
- 449 Q: Right. Okay. So in the meantime there after the shooting did you see
450 anything else? Any other movement in any other – did you hear anything
451 come from the inside? Did you hear any TV's on? Any music?
452
- 453 A: Well after both shootings I heard him yelling inside the, uh, inside the
454 building. And I heard him say, uh, F and I'm pretty sure he said you but I'm
455 not, you know, and then he'd – he'd give out like a war cry. You know like
456 they – occasionally the – some of the intoxicated gentlemen around here will
457 give out, uh, an Indian war cry. It sounded kinda like that.
458
- 459 Q: Okay. Can you – can you, um – so you heard him clearly. And how many
460 yards away were you when you were in that position number one.
461
- 462 A: I'm guessing or estimating – it was on an uphill slope – so I'd say anywhere
463 between 75 and 100 yards.
464
- 465 Q: Okay. So you're 75, 100 yards away from the – from the residence and you
466 could clearly hear him say, "Fuck you?"
467
- 468 A: Yes.
469
- 470 Q: Loud?
471
- 472 A: Yes.
473
- 474 Q: Uh, you could hear him with the war cry?
475
- 476 A: Yes. And that was coming – and I could tell just – I could tell that I – I
477 believed it was coming from either the middle or the forward part of the
478 house...
479
- 480 Q: Okay.
481
- 482 A: ...which would be the south end of the home.
483
- 484 Q: Uh, any other – anything else, uh, that he said?
485
- 486 A: Uh, no just he did that on a couple occasions.
487
- 488 Q: So do you think if he was yelling, "I give up, I surrender" could you have
489 heard him?

490
491 A: Yes. 'Cause he yelled at the, uh, voice (unintelligible) that volume yes I
492 would have heard him.
493
494 Q: Yes. Okay. Um, and could you estimate the time when you heard those?
495 Was it throughout the – the operation...
496
497 A: I think it was...
498
499 Q: ...or was it after the shooting?
500
501 A: It was throughout the operation.
502
503 Q: Uh-huh.
504
505 A: And he had to – he had to yell a minimum of two and, you know, a max of
506 three that I heard.
507
508 Q: Okay.
509
510 A: On different occasions throughout.
511
512 Q: Okay. Um, anything else that you saw?
513
514 A: No that was pretty much it. I saw SWAT team movement but...
515
516 Q: SWAT team movement. As far as the house goes, um, have you ever seen
517 any candles, candlelight or lamp light or the fire going in the fireplace
518 anything like that?
519
520 A: Uh, no. I did see I believe, uh, I saw a light flashing and then someone on the
521 radio said they believed he was watching television.
522
523 Q: Okay. Um, anything else you feel is pertinent to this?
524
525 A: I think, um, talking to Officer (Gyer) and Officer (Spulino) from (Hoopa)
526 Tribal Police (unintelligible) his mind set because they had taken him into
527 custody (unintelligible).
528
529 Q: Okay. Well – well I think someone's already talked to him but...
530
531 A: Okay.
532
533 Q: ...but, uh...
534

535 A: I wasn't sure.

536
537 Q: But we'll – I'll make sure of that...

538
539 A: All right.

540
541 Q: ...for sure. Uh, I think the interview's gonna be completed and it is 1052.

542
543
544 This transcript has been reviewed with the audio recording submitted and it is an accurate
545 transcription.

546 Signed _____

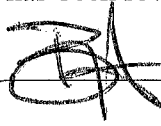
A handwritten signature in black ink, appearing to be the initials 'WH' or similar, written over a horizontal line.



HUMBOLDT COUNTY DISTRICT ATTORNEY'S OFFICE INVESTIGATION REPORT

DATE: July 18, 2007
CASE: HCSO #200703162

Witness: [REDACTED] Officer Rawland Swift, California Department of Corrections (CDC)
Pelican Bay

DA Investigator: William Honsal

Officer Rawland Swift, CDC Pelican Bay, submitted a report on his duties and observations regarding his involvement with the [REDACTED] incident. Refer to the attached memorandum for details. Due to the fact that Officer Swift was the squad team leader and assisted HCSO SWAT with the delivery of the CDC's Gas, I decided to contact him for additional information. On June 18th, 2007 at 1340 hours, I interviewed Rawland Swift regarding HCSO case # 200703162. The interview was conducted by telephone and was recorded on cassette. The following is a summary of Officer Swift's statement.

On June 4th, in the afternoon, HCSO commanders decided to introduce gas hand canisters inside the residence. HCSO requested mutual aid from CDC and their gas hand canisters for the operation. Team Leader Jeff Ricker took the Load Bearing Vest (LBV), which held their gas rounds, to the command post and explained each of the rounds to the SWAT commander. The HCSO SWAT commander requested the LBV be delivered to the HCSO SWAT officers on the #4 side. Officer Swift was the squad leader who was tasked with delivering the LBV containing all of CDC's gas rounds. When he got to the staging area on the #4 side of the house he gave the LBV to HCSO deputies. Officer Swift briefly explained each of the canisters to the deputies that were on scene. HCSO took three hand canisters from the LBV. They took one "Stingball" canister and two "internal flameless" canisters from the vest. Officer Swift and his team then took up a position and held the ballistic blanket while HCSO delivered the hand canisters to the #4 side. Officer Swift remembers seeing the deployment of the Flameless rounds to the #4 "A" window and to the "B" Window. He does not recall seeing HCSO deploy the stingball into the #4 side. After the gas delivery was made, Swift asked the deputies if they deployed the sting ball. The deputies told him the "Stingball" was the first round they deployed.

I asked Swift about the stingball and what it was designed to do? Officer Swift stated the stingball is a pyrotechnic device that shoots out rubber balls and chemical agent. The blast is loud and the effect is instant.

I checked the defense technology website and copied off the specifications for the "Stinger Grenade." Refer to the attached copy.

Disposition: Supplemental report referred to HCSO.

Memorandum

Date : June 7, 2007

To : Humboldt County
District Attorney Investigator

From : Rawland Swift Badge# 35101
Department of Corrections
Pelican Bay State Prison, P.O. Box 7000, Crescent City, CA 95532-7000

██████ : MUTUAL AID INVOLVEMENT IN THE JUNE 4, 2007, HOOPA INCIDENT

On June 4, 2007, I responded to a mutual aid request from Humboldt County as a member of the Pelican Bay State Prison (PBSP) Crisis Response Team (CRT).

Upon arrival at the crises site my involvement was as follows;

Mission one:

- I lead a squad from the command post staging area to the inner perimeter being held by a Humboldt County Swat Squad (corner 3 securing sides 3&4 of the crises site). The purpose of this mission was the delivery of necessary tactical equipment (Ballistic blanket, hooligan tool and pike pole) to the Squad holding that position. Upon delivery of the equipment my squad provided visual coverage of the crisis site while the Humboldt Squad carried out a gas deployment plan in which they utilized the ballistic blanket as protection and approached side four and deployed gas into windows A&B. The Squad backed away from the crises site behind the protection of the ballistic blanket and returned to their original position of cover. The Humboldt Squad took a short break to take in fresh air and water. Then relieved my Squad from their observation positions. I assembled my operators behind the protection of the ballistic blanket and returned to the command post staging area.

Mission two (some time later in the day):

- I again lead a squad from the command post staging area to the inner perimeter being held by the Humboldt County Swat Squad (corner 3 securing sides 3&4 of the crises site). The purpose of this mission was the delivery of necessary tactical equipment (Load Bearing Vest (LBV) containing CS gas and replacement gas masks) to Squad holding at that position. Upon delivery of the equipment my squad provided visual coverage of the crisis site while the Humboldt Squad carried out a gas deployment plan in which they utilized the ballistic blanket as protection and approached side 4 and deployed gas into windows A&B (same plan as prior). The Squad backed away from the crises site behind the protection of the ballistic blanket and returned to their original position of cover. Again the Humboldt

Squad took in fresh air and water. I watched the crisis site as the gas deployed inside the site (distinct white smoke). The smoke lasted two to four minutes. My visual observation was of sides 3&4. My best view was through window A&B on side 4. Several minutes after the white smoke stopped, I saw two puffs of black smoke come from window B on side 4. I informed the Command Post via radio of all of my visual and audible observations, black smoke indicated fire not gas. After quite some time the black smoke grew in intensity and eventually flames were spotted in window "A" on side 3 of the structure. I maintained my visual observation point until the Officer in charge of this crisis determined it was safe for firefighters to enter the scene and extinguish the flames. My squad accompanied the fire units and firefighters into close proximity of the crisis site and provided security at the request of the commanding officer. After the [REDACTED] was discovered incapacitated in the crisis site I was directed to reconsolidate my squad with the other PBSP CRT personnel and wait for instructions from the investigators on scene.

All observations were reported via radio to the command post during this incident. It should be noted I was only able to utilize the PBSP radio frequency. I was not able to communicate or hear any other agencies radio traffic. The PBSP CRT tactical operators on my squad and involved in the above missions were as follows;

- K. Charlton
- J. Lawrence
- C. McMillan
- M. Winningham

I had no other involvement in this crisis, should any other information be required I can be reached at Pelican Bay State Prison, (707) 465-1000, [REDACTED]



Rawland Swift
PBSP CRT Tactical Team Leader



STINGER® GRENADE

RUBBER PELLET

RP, RP/CS & RP/OC

BACKGROUND: The Stinger Grenade comes from the design of the Defense Technology #15 Stinger Grenade series. The Stinger Grenade is a combination Specialty Impact Munition and Diversion Device that may incorporate optional CS or OC-laden powder, if desired. The Stinger Grenade is a maximum effect device as it delivers up to four stimuli for psychological and physiological effect: rubber pellets, light, sound, and optional chemical agent or OC.

Code Recognition:	RP ONLY	RP/CS	RP/OC
CURRENT PART ID:	1090	1088	1089
DEFENSE TECHNOLOGY:	15RP	15RP/CS	15RP/OC
FEDERAL LABORATORIES:	N/A	N/A	N/A

PRODUCT SPECIFICATIONS

SUBMUNITION SPECIFICATIONS

Construction:	Rubber Ball Grenade Body	Active Agent:	CS - 0.07 oz. [2.0 grams] when applicable	
Explosive Compound:	8.0 grams Flash Powder		OC - 0.01 oz. [0.30 grams] when applicable	
Diameter:	3.1 inches 7.9 cm	Caliber:	32	
Length:	5.2 inches 13.2 cm	Diameter:	0.32 in.	0.81 cm
Projectiles:	180 Rubber Balls [approx.]	Pellet:	75 Durometer "A" Scale	
Launchable:	Yes			
Warranty:	5 years			

(Subject to change without notice. All specifications are averages.)

OPERATION: The Stinger Grenade has an initial 1.5-second delay that initiates fuze assembly separation, followed by another 0.5-second delay before the function of the device. The blast is sufficient to project the rubber balls and optional chemical agent in a 50-foot radius.

APPLICATION: The Stinger Grenade is most widely used as a crowd management tool by Law Enforcement and Corrections in indoor and outdoor operations. However, as with any pyrotechnic device fire-fighting equipment should be available. It has also proven successful in tactical operations.

As a pain compliance, distraction and disorientation device for crowd management, it may be hand thrown or launched in the general direction of the crowd. It may be deployed for ground bursts or aerial bursts at the discretion of the operator. It is generally reserved as a last selection when chemical agents and specialty impact munitions have not resolved the disorder or routed the crowd. It has been used quite successfully for several years in correctional and jail facilities against non-compliant or riotous inmates.

Its applications in tactical deployment situations include high-risk warrant service, hostage rescue, and the arrest of potentially violent [REDACTED]. The purpose of the Stinger Grenade is to minimize the risks to all parties through pain compliance, temporary distraction or disorientation of potentially violent or dangerous [REDACTED].

IMPROPER USE OF THE STINGER GRENADE CAN RESULT IN DEATH OR SERIOUS BODILY INJURY.

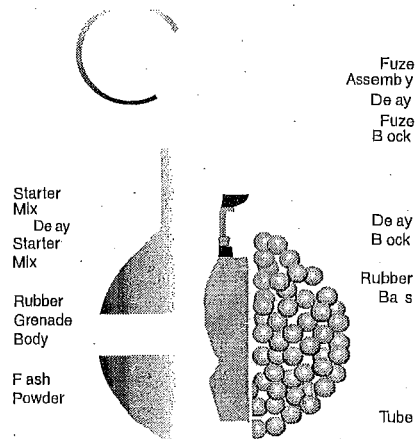

WARNING: This product is to be used only by authorized and trained Law Enforcement, Correction, or Military Personnel. This product may cause serious injury or death to you or others. This product may cause serious damage to property. Handle, store and use with extreme care and caution. Use only as instructed.

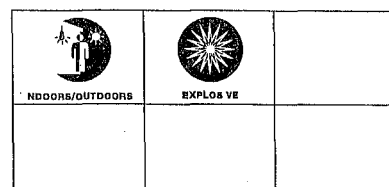



WE GO IN FIRST.

Home | Contact Us | Technical Resources | Training | News | Find a Rep | Product Demonstrations | Site Map

Quick Jump to Any Product

- AEROSOL ▾
- SPECIALTY IMPACT ▾
- CHEMICAL ▾
- TACTICAL ▾**
- LAUNCHERS ▾
- GAS MASKS ▾
- TRAINING ▾

TACTICAL



Stinger® Rubber Ball Grenade CS

PART IDs:

1088 CS

1089 OC

1090 Rubber Pellet Only

To psychologically and physiologically maximize less-lethal force against the most stubborn of crowds, the Stinger® rubber ball grenade offers the multiple stimulus of light, sound, rubber pellets and optional CS or OC chemical agents.

[Product Spec Manual >>](#)

[Material Safety Data Sheet >> 1088 CS](#)

[Material Safety Data Sheet >> 1089 OC](#)

[Material Safety Data Sheet >> 1090 Rubber Pellet Only](#)

QUICK SEARCH

GET THE ADVANTAGE OF
↓ **40MM FREE** ↓

FREE	FREE
Single Shot	Multi Shot
Promo	Promo



[← Back to Products](#)

 SEARCH by PART ID	 SEARCH Product SPEC SHEETS	 SEARCH Material SAFETY DATA SHEETS
------------------------------------------------------------------------------------------------------------------	---------------------------------------------------------------------------------------------------------------------------	-----------------------------------------------------------------------------------------------------------------------------------

© 2007 BAE Systems



HUMBOLDT COUNTY DISTRICT ATTORNEY'S OFFICE INVESTIGATION REPORT

DATE: July 18, 2007
CASE: HCSO #200703162
[REDACTED]
Witness: Officer Gary Cooper, Eureka Police Department-

DA Investigator: William Honsal

On June 11th, 2007 at 1000 hours, I interviewed Officer Gary Cooper, Eureka Police department, regarding HCSO case # 200703162. The interview conducted at the District Attorney's office and was recorded on cassette. The following is a summary of Cooper's statement. For a detailed statement refer to attached transcript of the interview.

Officer Cooper is currently employed as a Police Officer with the Eureka Police Department (EPD). He has 11 years of law enforcement experience. He is currently assigned to the Eureka Police Department Rifle Team and has 10 years of tactical operations experience with the HCSO SWAT team.

On June 3rd, 2007, Officer Cooper received a phone call notifying him of a SWAT callout. Cooper was advised that the Sheriff's office requested mutual aid regarding a barricaded [REDACTED] in Hoopa. At 2300 hours, Officer Cooper responded to EPD and loaded the police equipment into several vehicles. The EPD team deployed at 0100 hours and arrived at the scene, Bloody Camp Road and [REDACTED], Hoopa CA.

Upon arrival Officer Cooper put on his gear and waited for the information briefing. Sgt. Nova, EPD SWAT Commander, was given information from the Sheriff's Office on the situation status. Sgt. Nova then briefed all the officers regarding the [REDACTED] description and about the two shootings earlier in the night. EPD SWAT's role was to deploy around the residence and relieve the HCSO SWAT team. The SWAT team was go contain and maintain the perimeter around the residence.

Officer Cooper was deployed to the Northwest side near the Yurok Tribal police vehicle. Officer Cooper was teamed up with Officer Ron Harpham. Officer Cooper and Officer Harpham's job was to monitor the [REDACTED] movement on the West and North sides of the residence.

During the night Officer Cooper was using binoculars and night vision goggles to monitor the [REDACTED] movement inside the residence. Several times he observed a persons shadow inside the #4 side window. Based on the build and haircut Cooper believed the [REDACTED] to be a male. He observed the male [REDACTED] walking from room to room throughout the night. He could see shadows through the #1 side windows and the lights being turned on and off throughout the night. Cooper never heard the [REDACTED] make any attempt to give up or attempt to communicate with the police. Cooper just heard "banging" inside the residence throughout the night.

Cooper never observed the [REDACTED] inside the residence display a weapon or fire a weapon during the night. Cooper advised no weapons were fired or used by the police during the time he was on the perimeter.

At 0830 hours, HCSO SWAT personnel relieved Cooper and Harpham. EPD SWAT then returned to the Command Post where they rested and waited for further orders.

Later that morning, HCSO attempted negotiations with the [REDACTED] without any response. At that time it was determined that GAS was going to be deployed into the residence. HCSO requested EPD SWAT to assist with the GAS deployment. EPD SWAT staged behind the HCSO vehicles and HCSO personnel on the #4 side.

HCSO decided to introduce gas on both the #2 and #4 sides simultaneously. EPD SWAT then moved to the #2 side for GAS deployment. EPD SWAT was ordered to deploy 5 volleys of GAS into the #2 side window. The team moved to a position that was approximately 81 yards to the North of the #2 side. That was the closest position of cover on the #2 side. Cooper and Sgt. Johnson took a cover position on the #2 side to ensure the [REDACTED] would be contained.

After the volleys of gas into the #2 and #4 sides, Officer Cooper heard a lot of "Banging" sounds coming from inside the residence. According to Cooper, it sounded like [REDACTED] was trying to barricade himself inside the residence. .

Though out the incident, Officer Cooper could clearly hear Sgt. Fridley attempt to speak with [REDACTED] via the PA. Officer Cooper stated that Fridley kept trying throughout the incident. Officer Cooper stated it was to the point that he was tired of listening to it. Officer Cooper could clearly hear the negotiator from HCSO over the PA system. He estimated he was approximately 200 yards away from the PA and he was clearly articulate from that distance. He never heard [REDACTED] respond to the negotiation attempts.

Officer Cooper observed the HCSO SWAT personnel administer hand gas canisters into the #4 side. After the deployment of the hand canisters, Cooper observed thick white smoke emitting out of the windows. He observed the smoke mostly dissipate. A short time later Cooper noticed the smoke started emitting from the windows and roof. But the smoke had changed to gray. A short time later, Sgt. Fridley announced on the PA, "[REDACTED] your house is on fire, come out." Fridley attempted over and over again to try and talk [REDACTED] out of the residence. Office Cooper never observed or heard the [REDACTED] attempt to give up or communicate with the police.

According to Cooper, 20 or 30 minutes passed before the smoke reached from the #4 side to the #2 side. Cooper only observed smoke coming out of the #2 side. He only observed flames coming from the #4 and #3 sides. Officer Cooper and his team held their positions the entire time in case [REDACTED] surrendered or needed to be rescued from the residence. They gave up their positions when HCSO called in the fire engines to suppress the fire. When HCSO SWAT moved in as cover units for the fire suppression, EPD SWAT team then stood down. Officer Cooper and his team then

responded back to the command post where they were checked out by the investigation team.

Officer Cooper did not observe [REDACTED] fire his weapon during the incident. He did not shoot his weapon or observe any officers shoot their weapons during the entire incident. All rounds from his weapon were accounted for.

Disposition: Supplemental report referred to HCSO.

1
2
3
4
5
6
7 **INTERVIEW WITH (GARY) COOPER**

8 Q=William Honsal

9 A=(Gary) Cooper

10
11
12 Q: Ah, we're going on tape. It is ah, June 11 at 10:00 am. Talking to Officer
13 (Gary) Cooper, Eureka Police Department, in regards to the ah, incident that
14 happened off of Bloody Camp Road in Hoopa over the course of June 4 and
15 5th. Third and fourth, sorry. And ah, so (Gary) could you spell the last - your
16 last name for the record?

17
18 A: Sure. It's C-O-O-P-E-R.

19
20 Q: Okay. On June 3 of 2007 did you receive a page, SWAT page or a call from
21 ah, the SWAT commander (Bill Nova)?

22
23 A: I actually received it from another team member.

24
25 Q: Okay.

26
27 A: And they said they received a phone call and (unintelligible) the call.

28
29 Q: Okay. And that call out consisted of a barricaded [REDACTED] up in Hoopa?

30
31 A: Correct.

32
33 Q: Okay. At some time did you respond to EPD and load up and respond out to
34 the scene?

35
36 A: Yes we did.

37
38 Q: What time was that roughly?

39
40 A: Um, I arrived at the office at 11 o'clock at night. Um, it was probably -- I
41 didn't pay much attention to the time -- two hours maybe later that we actually
42 left after loading up some gear and getting dressed up.

43
44 Q: Okay. So you probably left around 1:00 am?

45

46 A: Around there. I didn't really pay attention to the time.
47
48 Q: Okay. What - what is your role basically um, for this call out?
49
50 A: Um, I'm considered one of the department's um, I don't know what's the term.
51 It's ah...
52
53 Q: Patrol rifle.
54
55 A: Patrol rifle, yes thank you.
56
57 Q: No problem.
58
59 A: And that was to assist the ah, SWAT team with whatever they needed, be it
60 security, um, entry if I had to or whatever the - the ah, team leader or SWAT
61 commander deemed necessary.
62
63 Q: Okay. And can you just briefly describe um, ah, your training and experience
64 in law enforcement in dealing with these kind of incidents.
65
66 A: Um, I worked at the sheriff's department for 11-1/2 years. The first of this
67 year 2007 I lateralled over to EPD. I was on the SO SWAT team for ten
68 years, almost ten years. Um, you know, I've had numerous call outs, um, you
69 know, been to basic SWAT, advanced SWAT. Um, held pretty much every
70 position on the team at the sheriff's department -- team leader, gas, entry,
71 pretty much every position there. Um...
72
73 Q: Okay.
74
75 A: So I do have experience with these types of scenarios.
76
77 Q: Okay, so this isn't your first call out obviously.
78
79 A: No.
80
81 Q: Okay. So you went out to the scene about 1:00 am um, and at some time did
82 you get deployed out um, to the residence?
83
84 A: Yes. After we arrived we were briefed by um, well Sergeant (Noble) was
85 briefed by the sheriff's department on what the situation was. After he was
86 briefed he came back and briefed us and advised us that we'd be replacing the
87 sheriff's department in their positions.
88
89 Q: Okay. At what time did you get deployed out to replace the sheriff's office?
90

91 A: I have no idea what the time was.
92
93 Q: I mean was it still dark out?
94
95 A: It's still dark. Early morning.
96
97 Q: Early morning.
98
99 A: Three, 4:00 in the morning, somewhere around there.
100
101 Q: Okay. So at 3:00, 4:00 in the morning, what were your orders?
102
103 A: Um, at that time we were split up into two man teams and I was paired with
104 Officer Harpham. And we were going to deploy ah, to a position the sheriff's
105 department was at on the northwest side of the ah, structure.
106
107 Q: Okay. And what was your duty? What was your deployment orders at that
108 point?
109
110 A: Just to simply observe and ah, hold the perimeter and if the [REDACTED] did come
111 out to contain.
112
113 Q: Okay. So you went to the northwest corner. That's the number one two side
114 there.
115
116 A: Correct.
117
118 Q: Okay. And did you - were there any windows or any doors on that side?
119
120 A: Yes. On this hand drawn sketch that you provided e...
121
122 Q: Mm-hmm.
123
124 A: I believe this is Y - Yurok PD.
125
126 Q: Yes.
127
128 A: We actually took position originally there.
129
130 Q: Okay.
131
132 A: And we could see the door on the one side, the window on the one side and
133 the windows on the two side. It's actually back a little bit further so you have
134 a little bit better view of it.
135

136 Q: Good okay. Can you ah, draw number one were you were initially deployed
137 there?
138
139 A: Sure. You just want me to put a number one?
140
141 Q: Yeah, just put a number one there. And then can you draw in the window and
142 the door that you are referring to?
143
144 A: Sure.
145
146 Q: On the drawing.
147
148 A: The door is marked. And there is two lines.
149
150 Q: Okay.
151
152 A: I'll just write door.
153
154 Q: Okay.
155
156 A: If that's fine. And there was a window...
157
158 Q: So that was your position - go ahead.
159
160 A: I was going to say, on the number two side there was also a window.
161
162 Q: Go ahead and draw a window in there. You can see it from that position?
163
164 A: Mm-hmm.
165
166 Q: So how long did you hold um, the position on the one two corner there?
167
168 A: Um, until we were relieved by the sheriff's department. But as the sun came
169 up it was a very precarious position because it was out in the open.
170
171 Q: Got you.
172
173 A: So the road - and it's hard to depict on this sketch.
174
175 Q: Mm-hmm.
176
177 A: Went back father to the west. Okay? Um, and the road actually made a bend.
178 So we were actually able to move this vehicle, the Yurok PD vehicle, around
179 the bend and deploy from there about ah, I don't know what the distance was.
180 It was a little bit further but it did give us a little bit more cover.

181
182
183
184
185
186
187
188
189
190
191
192
193
194
195
196
197
198
199
200
201
202
203
204
205
206
207
208
209
210
211
212
213
214
215
216
217
218
219
220
221
222
223
224

Q: Okay.

A: But we could still see the one two side (unintelligible).

Q: Good deal. So you were there all the way through daybreak I guess?

A: Correct, until about 8:00, 8:30 when we were relieved by the sheriff's department.

Q: Through the night did you see any activity out of those windows and doors on that one two side?

A: Yes we did.

Q: Okay, can you describe that activity that you saw inside there?

A: Yeah. I mean number two side we repeatedly saw a male [REDACTED] ah, appeared to be a male [REDACTED] based on the build and the haircut, come to the number two window, stand in the window and then we would see them moving around in there, because there was a lot of backlight from inside the residence.

Q: Okay.

A: And we were using just binoculars, I believe Officer Harpham has a scope on his rifle. And we were also using night vision goggles. Um, you could - I don't - I don't know what the person was doing inside the residence. Um, then you'd see him walk in front of other windows, like walk in front of the light.

Q: Mm-hmm. Were the windows open, closed? I mean shades and glass?

A: The actually glass was closed.

Q: All right.

A: But the window on the number two side he had some kind of drape or curtain or something that he was able to close. And he would. He'd open it and close it, open it and close it several times throughout the night.

Q: Okay.

A: Or I guess, I'm sorry, early morning since we (unintelligible).

225 Q: At any point did you see him have a rifle in his hand or a handgun or any type
226 of firearm?
227
228 A: I did not.
229
230 Q: Um, at any point did you hear him um, say that he wanted to give up?
231
232 A: No I did not. The only thing I heard was him making banging noises inside
233 the - inside the residence.
234
235 Q: And then how um, just the environment, can you describe the ah, weather that
236 night?
237
238 A: Um, it was clear. It did get a little overcast. It sprinkled off and on a couple
239 times and then as it drew more towards ah, daybreak it actually clouded over
240 and became pretty - pretty overcast.
241
242 Q: Ah, was it quiet out there?
243
244 A: Yeah. There was some horses and cows, and there was actually a couple dogs
245 running around. And we could hear the next residence behind us, their dog
246 barking assuming at us and vehicle traffic and things, but nothing close by.
247
248 Q: So the power was on inside the residence?
249
250 A: Yes, I don't believe he any type of generator or anything.
251
252 Q: Okay.
253
254 A: We didn't hear a generator. There was power lines going there so I believe he
255 did have power supplied by local power.
256
257 Q: Okay. And ah, was there any music? Was there music on? Was their
258 television?
259
260 A: There appeared to be in a back room, which would be the ah, oh, four side,
261 which would be the south side of the residence, because there was a window
262 on the ah, southwest corner. There appeared to be a TV. You could see it
263 flickering all through the night.
264
265 Q: Okay. Um, and do you feel like if the [REDACTED] came to the window at any time
266 in the night you would have seen him and as far as him wanting to give up?
267
268 A: Absolutely.
269

270 Q: If he stands at the window and said, I want to give up?
271
272 A: Absolutely. We had a very clear view of the windows on the west side and
273 the north side.
274
275 Q: Okay. So at some time in the morning, um, so you didn't have any [REDACTED]
276 contact through the night?
277
278 A: No. We were just seeing him through the window.
279
280 Q: And you didn't fire your weapon?
281
282 A: No.
283
284 Q: Were there any weapons fired when you were deployed by any of the
285 officers?
286
287 A: No.
288
289 Q: Okay. Did the [REDACTED] fire while you were in that position?
290
291 A: No.
292
293 Q: Okay. So sometime in the morning about 8:30 you said you were relieved by
294 the sheriff's office.
295
296 A: Correct.
297
298 Q: Okay. Where were - where did you go after that?
299
300 A: Um, after that ah, we walked to the north and then around to the east to get
301 back down to where the command post was.
302
303 Q: Okay. And what were your orders at that point when you reached the
304 command post?
305
306 A: Ah, take our gear off, stand down, relax, drink some water and just be
307 prepared for if something else happened to respond to that.
308
309 Q: Okay. At some point did you ah, respond back to the residence and - later on
310 that morning?
311
312 A: Yes we did.
313
314 Q: Okay. What were your orders at that point?

315
316 A: Initially, ah, the road coming in ah, we were to back the sheriff's department if
317 they needed assistance deploying gas. We were staged behind their vehicles
318 with our team and gas guns. It didn't require - they didn't require us - our
319 assistance, but they wanted to introduce gas through a different window on the
320 residence. So the sheriff's department held their position with their gas team
321 on the south side, which is the southeast side I believe, and we walked around
322 to come in from the north and east side of the residence.
323
324 Q: Okay. And so um, did you deploy gas or did someone deploy gas from your
325 team at that point?
326
327 A: Yes they did.
328
329 Q: Can you mark with a number two the spot or approximately the directional
330 location um, where you guys were positioned on the number two side?
331
332 A: Roughly - it's not 100% accurate, but roughly - number two.
333
334 Q: Okay. And then approximately how far away were you from ah, the number
335 two side?
336
337 A: About 81 yards, because I had originally used Officer Harpham's ah, range
338 finder...
339
340 Q: Okay.
341
342 A: To move forward to try to get us in good position to launch the gas from.
343
344 Q: At that point, um, 81 yards away, um, the sheriff's office was actively
345 administering gases in the four side.
346
347 A: Correct.
348
349 Q: And you guys were there. And ah, did you see um, did you see the gas being
350 dispersed inside of the number four side?
351
352 A: Not inside the residence. But I - one of the rounds that they used, I could see
353 it actually coming back out on the number four side.
354
355 Q: Okay. Um, did um, at this time when you were 81 yards away from the
356 number two side, were they actively engaged in negotiations? Was there
357 someone trying to convince the [REDACTED] to come out?
358

359 A: Yes, the ah - we could hear the P - they tried to get his attention using the
360 siren.
361
362 Q: Okay.
363
364 A: And then I believe it was Sergeant (Fridley)...
365
366 Q: Okay.
367
368 A: From the sheriff's department. I could hear his voice clearly on the PA system
369 telling [REDACTED] or whatever the guy's name was to come out with your hands
370 up, don't come out with the gun. You know, surrender. Over and over and
371 over we could hear him give him...
372
373 Q: How many times do you think you heard?
374
375 A: It got to the point where we were tired of listening to...
376
377 Q: Really.
378
379 A: Sergeant (Fridley). Yes. It was non stop.
380
381 Q: You were 81 yards away from the number two side. How far do you think
382 you were away from that PA system approximately?
383
384 A: Um, the vehicle actually sat back so they were quite a ways from us doing it.
385 A couple hundred yards easily.
386
387 Q: Okay. So maybe 200 yards away you could clearly hear him.
388
389 A: Yes.
390
391 Q: So in your estimation, could he be clearly heard inside that residence?
392
393 A: Yes. There was, you know, no loud stereos, no loud noise coming from inside
394 the residence to - that we could hear.
395
396 Q: At any point when you're on that side when they're administering gas number
397 four side, did you see the [REDACTED] come out the number two side, the opposite
398 site where they are administering gas to give up?
399
400 A: No.
401
402 Q: Ah, to escape, nothing like that?
403

404 A: No, nothing.

405

406 Q: Did you see any [REDACTED] movement in the number two side?

407

408 A: No. We just heard some banging noises coming from inside the residence.

409

410 Q: And what did you attribute those banging noises too?

411

412 A: I'm not sure. We thought maybe he was trying to barricade himself in, maybe
413 dig through the floors. It's hard to tell.

414

415 Q: Yeah, okay.

416

417 A: So.

418

419 Q: Okay. So subsequently gas was administered on the number two side from
420 that position. Um, and did - did you see any affect from that gas being
421 administered by the EPD team?

422

423 A: Um, due to the - the slope, because the structure was actually downhill from
424 our position and we were at an angle, they had a difficult time getting the gas
425 through the widow.

426

427 Q: Mm-hmm.

428

429 A: Um, but once they did get it in, it was hard to tell how it dispersed inside.

430

431 Q: Okay.

432

433 A: The ah, this part of the structure.

434

435 Q: Okay. So at some point um, the sheriff's office ah, decided they were going to
436 throw hand canisters in the number four side.

437

438 A: Mm-hmm.

439

440 Q: Ah, did your - did your placement ah, change at that point from the number
441 two side?

442

443 A: No.

444

445 Q: Are you still in the position?

446

447 A: We ah, Officer- or Sergeant (Johnson) and I stayed on the number two side
448 and the rest of the team moved to ah, I believe the number three side to try and

449 introduce gas through a window in the number three side. So my position
450 stayed the same with Sergeant (Johnson). But the rest of the team moved
451 around to the three side.

452
453 Q: So then your job was to contain the north side, the number two side?

454
455 A: Correct.

456
457 Q: So at some point the sheriff's office administered hand canisters into the
458 number four side. Did you see ah, the agent dispersing in the residence at that
459 point?

460
461 A: I mean I could see it coming back out of the residence through the vent in the
462 roof. Um...

463
464 Q: Was it - was that a noticeable difference than um, than the 37 millimeter?

465
466 A: Some of the 37 you could see coming back out. But it wasn't as um, I guess
467 you'd say thick.

468
469 Q: Okay.

470
471 A: It was - the 37 millimeter was very sparse.

472
473 Q: Sparse?

474
475 A: In comparison.

476
477 Q: Hand canisters, what kind of smoke? Can you describe the smoke that was
478 coming out?

479
480 A: Um, it was thicker.

481
482 Q: That you saw.

483
484 A: I could see white color, um...

485
486 Q: Okay. At some point um, did the smoke change color?

487
488 A: Ah, yes it did.

489
490 Q: Okay. And um, was there a ah, I know you couldn't - from your position
491 could you see the canisters being thrown in from the sheriff's office in the
492 (unintelligible) side?
493

494 A: No. This side of the residence is on a downhill slope, farther down than
495 where we had - we could have visual on.
496

497 Q: Okay. Um, and so you couldn't really - so you couldn't see them administer
498 it?
499

500 A: No.
501

502 Q: Okay. So ah, did you see the ah - can you just if you can describe um, ah, the
503 time line if you can approximately of when you saw the - the smoke being
504 discharged from the hand canisters and then the time when the smoke
505 changed.
506

507 A: Um, it wasn't real long. I don't - I didn't even look at my watch because we
508 were waiting that hopefully this guy would give up and we would be done. I
509 couldn't even really give you a time. It wasn't long at all, because it was like
510 from a white smoke to a grey smoke. It was kind of hard to describe.
511

512 Q: And was it a continuous thing that the white smoke turned into grey smoke or
513 was it a thing where the white smoke dissipated and then grey smoke started?

515 A: The - the white smoke for the most part dissipated. And I mean it's still kind
516 of just a little bit coming out. But then there was the ah, grey smoke shortly
517 thereafter.
518

519 Q: Okay. Um, at that point did you see any of that white smoke or grey smoke
520 um, instantly fill that residence and actually come out the number two side?
521

522 A: It took a while before it actually came out the number two side. It was just a
523 real small amount that came out of the number two side.
524

525 Q: If you can estimate that time when?
526

527 A: Oh gees, it was quite a while.
528

529 Q: Okay
530

531 A: Because Sergeant (Johnson) and I were talking. We were like, well he must
532 have the door closed and something shoved under the door to keep the smoke
533 from - because you could see it coming out the number four side very visibly.
534 The number two side was just trickling out the holes that our gas guys had
535 made in the windows. I mean it wasn't - there wasn't as much smoke coming
6
537 out the number two side as it was the number four.

538 Q: At some point did they ah, did someone notice that the smoke had changed
539 and there was actually a fire inside the residence?
540

541 A: I believe it was the sheriff department's team on the number four side that first
542 noticed the ah, the fire. They actually had flames and it was starting to build.
543 And we were all starting to notice the flames and thicker smoke from the
544 number two side on the north side.
545

546 Q: Ah, what happened? Um, did - did um, negotiations or did anyone call
547 attention to the fire?
548

549 A: Everybody saw it. I mean it was relayed up the chain. You know, all the ah,
550 commanders for both teams knew it. Ah, but again negotiations were still
551 going on. We could still hear Sergeant (Fridley) on the PA system telling the
552 guy, you know, come out, come out with your hands up, trying to get him to
553 surrender.
554

555 Q: Okay. Even when the house is on fire?
556

557 A: Correct.
558

559 Q: Okay. And um, did you hear Officer (Fridley) or Sergeant (Fridley) call
560 attention to the fire?
561

562 A: He told ah, through his negotiations he was telling this guy, his name is
563 () if I can remember.
564

565 Q: That's correct.
566

567 A: Hey, your house is on fire, you know, come on. We don't want to see you get
568 hurt. Come out with your hands up, you know, surrender. Just over - I mean
569 to the point that we were tried of hearing him on these loudspeakers.
570

571 Q: And it was definitely loud enough you could clearly hear it was Sergeant
572 (Fridley)?
573

574 A: Oh yes. Mm-hmm.
575

576 Q: And you were 200 yards away?
577

578 A: Yeah, I recognized his voice so.
579

580 Q: Okay. And so the fire started on the number four side. You're on the number
581 two side.
582

583 A: Mm-hmm.
584
585 Q: It slowly progressed from the number four side northward to the number two
586 side.
587
588 A: Mm-hmm. Correct.
589
590 Q: To the point where you saw smoke coming out there.
591
592 A: Mm-hmm.
593
594 Q: It took quite a long time.
595
596 A: Yeah.
597
598 Q: Would you say 30 minutes, 40, 50? An hour, two hours?
599
600 A: Twenty, 30 minutes maybe.
601
602 Q: Twenty, 30 minutes.
603
604 A: It was hard to tell because I mean we were really expecting this guy to come
605 out at this point so.
606
607 Q: So did you um, did the [REDACTED] come out of that number two side? Did you
608 see any movement inside there? Did you hear any voices?
609
610 A: None.
611
612 Q: None.
613
614 A: None.
615
616 Q: So fire occurred on the number four side, naturally someone would have come
617 to the number two side away from the fire.
618
619 A: You'd think.
620
621 Q: Okay. And was that window big enough that someone could have crawled
622 out?
623
624 A: Oh easily.
625
626 Q: And be rescued out of there?
627

628 A: You could have fit your desk through there. There was a very large, big...
629
630 Q: Okay. And at what point did you see flames?
631
632 A: Not out the window.
633
634 Q: Okay. How about on the number four side? Could you see flames?
635
636 A: We could see flames coming up over the top of the roof.
637
638 Q: Ah, when the flames were coming up over the top of the roof, could you see
639 into that number two window still?
640
641 A: No, just the smoke trickling out through the holes that our gas guys had made.
642
643 Q: Okay. Okay, so um, at some - when did you decide to leave your position,
644 your number two position?
645
646 A: Ah, once the ah, the structure became fully involved. I mean, because we
647 stayed there for a while watching it, thinking this guy has got to come out
648 sometime. Um, once the fire became fully involved and the fire department
649 came in - once the fire department came in and the sheriff's department
650 SWAT team provided the security for the fire department so they were in
651 close, it kind of created a cross fire if we were going to have to take a shot or
652 do something. So that's why we ah, secured from that position and walked
653 back to the command post.
654
655 Q: In your opinion, do you think someone could have - if someone was in the
656 number two um, room there that you were watching, when you left, was it
657 survivable if someone was?
658
659 A: It's hard to say. Um, there was - wasn't as much smoke coming out of there.
660 And like I said, we thought, you know, the door was closed, maybe he'd
661 shoved some wet towels or something. It's hard to say. At that point I don't
662 know where the fire was at inside the structure.
663
664 Q: Okay. But there was still a lot of smoke coming out of there?
665
666 A: Correct.
667
668 Q: And ah, if someone wanted to give up, you were in position, but you were
669 inclined to think it's not very survivable if someone was inside that?
670
671 A: At that point no, because the structure was pretty much fully involved.
672

673 Q: Okay. Um, and at that point ah, where did you go?
674
675 A: Um, after the sheriff's department moved in to provide security for the fire
676 department, we walked back up, kind of the northeast and then back to the
677 command post.
678
679 Q: Okay. And were you done at that point?
680
681 A: Um, we were told to stand by for ah, your office, um, that they wanted to
682 come and check our gear, take a picture, you know, see how many rounds we
683 had type of thing.
684
685 Q: Okay.
686
687 A: So we had a sandwich and we just stood there and wait.
688
689 Q: Good deal.
690
691 A: At the point where you were redeployed out to that number two side, did you
692 shoot your weapon?
693
694 Q: No. Ah, did any of your team shoot their weapons?
695
696 A: No.
697
698 Q: Did you see the [REDACTED] shoot his weapon?
699
700 A: No.
701
702 Q: Okay. Um, anyone from the sheriff's office?
703
704 A: No.
705
706 Q: Besides gas.
707
708 A: No. When - by the time we had gotten there, whatever shooting had taken
709 place they were done with that and the [REDACTED] didn't shoot any more rounds
710 and neither did we.
711
712 Q: Okay. Ah, I think this is going to conclude the interview. Do you have
713 anything else that would ah...
714
715 A: No.
716
717 Q: Thanks (Gary). We're off tape at 10:20.

718

719

720 This transcript has been reviewed with the audio recording submitted and it is an accurate
721 transcription.

722

Signed _____



HUMBOLDT COUNTY DISTRICT ATTORNEY'S OFFICE INVESTIGATION REPORT

DATE: July 20, 2007
CASE: HCSO #200703162

Investigator: William Honsal

On June 4th, 2007 I was assigned to assist the Humboldt County Sheriff's office with an officer involved shooting that occurred near Bloody Camp Road, Hoopa. Upon arrival, I was assigned to inspect the weapons of the officers that were coming off the line.

Chief Hislop and/or myself inspected all weapons. Each SWAT officer's weapon was logged with serial numbers, # of magazines, and ammunition. Refer to the attached reports for details.

Disposition: Supplemental report referred to HCSO.

Humboldt County Sheriff

Officer	Handgun	Serial #	Magazines	Ammo	Fired
Quenell	Glock 22	██████████	3 (15 rounds)	.40 x 46	
	Long Gun	Serial #	Magazines	Ammo	
Barney	Colt M16-A2	██████████	2 (30 rds) 1 (20 rds)	.223 x 78	2 rounds fired
	Handgun	Serial #	Magazines	Ammo	
Gomes	Glock 22	██████████	3 (15 rounds)	.40 x 46	
	Long Gun	Serial #	Magazines	Ammo	
B.Taylor	Colt M16-A2	██████████	3 (30 rounds)	.223 x 88	2 rounds fired
	Handgun	Serial #	Magazines	Ammo	
Massaro	Glock 22	██████████	2 (14 rds) 1 (15 rds)	.40 x 44	
	Long Gun	Serial #	Magazines	Ammo	
Bishop	Colt M16-A2	██████████	1 (30 rds) 2 (20 rds)	.223 x 68	2 rounds fired
	Handgun	Serial #	Magazines	Ammo	
Lundie	Glock 22	██████████	3 (15 rounds)	.40 x 46	
	Long Gun	Serial #	Magazines	Ammo	
Ireland	Colt M16-A2	██████████	Unknown	.223 x 110	1 round fired
	Handgun	Serial #	Magazines	Ammo	
Miller	Glock 22	██████████	3 (15 rounds)	.40 x 46	
	Long Gun	Serial #	Magazines	Ammo	
Fulton	Colt M16-A2	██████████	3 (20 rds) 1 (30 rds)	.223 x 89	
	Handgun	Serial #	Magazines	Ammo	
Garcia	Glock 22	██████████	3 (15 rounds)	.40 x 46	
	Sniper Rifle	Serial #	Magazines	Ammo	
J. Taylor	Remington 700	██████████	internal 5 rounds	.308 x 4	
	Handgun	Serial #	Magazines	Ammo	
J. Taylor	Glock 22	██████████	Unknown	.40 x 46	
	Long Gun	Serial #	Magazines	Ammo	
J. Taylor	Colt M16-A2	██████████	Unknown	.223 x 89	
	Handgun	Serial #	Magazines	Ammo	
J. Taylor	Glock 22	██████████	Unknown	.40 x 46	
	Sniper Rifle	Serial #	Magazines	Ammo	
J. Taylor	Remington 700	██████████	internal 5 rounds	.223 x 5	
	Handgun	Serial #	Magazines	Ammo	
J. Taylor	Glock 22	██████████	3 (15 rounds)	.40 x 46	
	Long Gun	Serial #	Magazines	Ammo	
J. Taylor	Colt M16-A2	██████████	3 (30 rounds)	.223 x 90	
	Handgun	Serial #	Magazines	Ammo	
J. Taylor	Glock 22	██████████	3 (15 rounds)	.40 x 46	
	Long Gun	Serial #	Magazines	Ammo	
J. Taylor	Colt M16-A2	██████████	Unknown	.223 x 78	
	Handgun	Serial #	Magazines	Ammo	
J. Taylor	Glock 22	██████████	Unknown	.40 x 43	
	Long Gun	Serial #	Magazines	Ammo	
J. Taylor	Colt M16-A2	██████████	Unknown	.223 x 80	
	Handgun	Serial #	Magazines	Ammo	
J. Taylor	Glock 22	██████████	1 (15 round)	.40 x 16	
	Long Gun	Serial #	Magazines	Ammo	
J. Taylor	Colt M16-A2	██████████	Unknown	.223 x 70	

Eureka Police Department

Officer Sgt. Nova	Handgun Glock 22	Serial # [REDACTED]	Magazines 3 (14 rounds)	Ammo .40 x 43
	Long Gun None	Serial # [REDACTED]	Magazines 3 (30 rds) 1 (20 rds)	Ammo .223 x 110
Officer Cooper	Handgun Glock 22	Serial # [REDACTED]	Magazines 3 (14 rounds)	Ammo .40 x 43
	Long Gun Colt AR-15	Serial # [REDACTED]	Magazines 4 (30 rounds)	Ammo .223 x 120
Officer Reyna- Sanchez	Handgun Glock 22	Serial # [REDACTED]	Magazines 3 (14 rounds)	Ammo .40 x 43
	Long Gun Colt AR-15	Serial # [REDACTED]	Magazines 5 (30 rounds)	Ammo .223 x 145
Officer Wilcox	Handgun Glock 22	Serial # [REDACTED]	Magazines 4 (14 rounds)	Ammo .40 x 57
	Long Gun Colt AR-15	Serial # [REDACTED]	Magazines 2 (30 rds) 4 (20 rds)	Ammo .223 x 138
Officer Harpham	Handgun Glock 22	Serial # [REDACTED]	Magazines 3 (14 rounds)	Ammo .40 x 43
	Long Gun Olympic AR-15	Serial # [REDACTED]	Magazines 2 (20 rounds)	Ammo .223 x 46
	Sniper Rifle Winchester 70	Serial # [REDACTED]	Magazines 4 (10 rounds)	Ammo .308 x 40
Officer Jones	Handgun Glock 22	Serial # [REDACTED]	Magazines 6 (15 rounds)	Ammo .40 x 90
	Long Gun Colt AR-15	Serial # [REDACTED]	Magazines 6 (30 rds) 3 (20 rds)	Ammo .223 x 240
Officer Hill	Handgun Glock 22	Serial # [REDACTED]	Magazines 3 (14 rounds)	Ammo .40 x 43
	Long Gun Colt M16-A1	Serial # [REDACTED]	Magazines 1 (30 rds) 2 (20rds)	Ammo .223 x 65
Officer Johnson	Handgun Glock 22	Serial # [REDACTED]	Magazines 3 (14 rounds)	Ammo .40 x 43
	Long Gun Colt AR-15	Serial # [REDACTED]	Magazines 3 (30 rds) 2 (20 rds)	Ammo .223 x 125
Officer Altic	Handgun Glock 22	Serial # [REDACTED]	Magazines 3 (15 rounds)	Ammo .40 x 46
	Long Gun Colt M16-A1	Serial # [REDACTED]	Magazines 3 (30 rds) 2 (20 rds)	Ammo .223 x 125



HUMBOLDT COUNTY DISTRICT ATTORNEY'S OFFICE INVESTIGATION REPORT

DATE: July 16, 2007
CASE: HCSO #200703162

Witness: Officer R. Reyna-Sanchez, Eureka Police Department

DA Investigator: William Honsal

On June 7th, 2007 at 2130 hours, I interviewed Officer Rodrigo, Eureka Police department, regarding HCSO case # 200703162. Eureka Police Detective Kevin Lawson assisted me in the interview. The interview was recorded on cassette and the following is a summary of his statement. For a detailed statement refer to attached transcript of the interview.

Officer Reyna-Sanchez is currently employed as a Police Officer with the Eureka Police Department (EPD). He has been a police officer with EPD for 8 years. He has been assigned to the Special Weapons and Tactics (SWAT) team for 5 years. He is currently assigned as the assistant Team Leader for the Eureka PD SWAT team.

On June 3rd, 2007, Officer Reyna-Sanchez received a page notifying him of a SWAT callout. Sgt. Bill Nova, Eureka PD SWAT Commander, advised that the Sheriff's office requested mutual aid regarding a barricaded [REDACTED]. The [REDACTED] [REDACTED] had fired a rifle at the Sheriff's officers when they attempted to do a welfare check. The Sheriff had deployed their tactical team and contained the [REDACTED] to the residence. The sheriff then called EPD SWAT to respond to the scene to assist in the operation. Sgt. Nova advised EPD SWAT, 3 members from patrol rifle team, and Negotiators to be ready to deploy from EPD at 0030 hours.

Officer Reyna-Sanchez responded to EPD and loaded the SWAT equipment into several vehicles. The SWAT team deployed at 0030 hours and arrived at the scene, Bloody Camp Road and [REDACTED] road at 0300 hours. Upon arrival Officer Reyna-Sanchez, Sgt. Nova, and Officer Todd Wilcox met with Lt. Cavinta and Sgt. Quenell in the HCSO Command Post. Lt. Cavinta briefed them on the incident. The Briefing included a sketch of the residence and surrounding areas. The positions of the HCSO SWAT personnel were also displayed on the board.

The rules of engagements were discussed at the command post. Lt. Cavinta advised the personnel, "React to the Threat." EPD SWAT's primary role was to deploy around the residence and relieve the sheriff's tactical team during the night. The SWAT team was to observe the residence and report any [REDACTED] movement or contact. If the [REDACTED] wanted to give up they were in a position to take him into custody. If the [REDACTED] exited the residence and threatened deadly force or shot at the officers, they were authorized to protect their lives or the lives of other's in accordance to EPD use of force policy.

6 members of EPD SWAT team were then deployed around the residence at approximately 0310 hours and they relieved the Sheriff's deputies. The EPD SWAT officers took positions on the South side (Side 4) and on the Northwest side (Side #1 at (Side #2). At 0410 hours, Officer Reyna-Sanchez deployed with Officer Altic to the east side of the residence (Side #3). Their role was to watch the #3 side for any movement.

During the night Officer Reyna-Sanchez positioned himself approximately 70 yards away. Observed light on through the Side #3 window. Officer Reyna-Sanchez observed a figure move in the #3, "A" window. Officer Reyna-Sanchez heard what appeared to be the [REDACTED] walking around inside the residence. He heard movement from the #4 side to the #2 side. At 0500-0530, the lights inside the residence went dark. Reyna-Sanchez did not hear the [REDACTED] attempt to communicate with police. Reyna-Sanchez stated if the [REDACTED] attempted to talk to the officers during the night he would have been able to hear the [REDACTED]. Officer Reyna-Sanchez stated that the night was calm and at times there was a full moon. Near dawn it started to sprinkle. In the morning the sprinkles turned to rain.

From 0300 to 0700 hours, Officer Reyna-Sanchez and the EPD team did not have any contact with the [REDACTED]. There were no shots fired, negotiations were not attempted and gas was not deployed. At 0830 HCSO tactical team redeployed around the residence and relieved EPD SWAT. EPD SWAT team responded back to the command post where they rested.

At 0930 hours, HCSO attempted negotiations with the [REDACTED] without any response. At that time it was determined that GAS was going to be deployed into the residence. HCSO requested EPD SWAT to assist with the GAS deployment. HCSO was going to administer two volleys of GAS into the #4 side. EPD SWAT was requested to deliver follow up volleys if necessary. The teams were ready to deploy when they received a stand down order, because the command post wanted a Medical helicopter flown in for rapid transport if necessary.

At 1330 hours, HCSO negotiators advised over a loud speaker to give up. Sgt. Fridley attempted to talk to [REDACTED] for 25 minutes. After there was no response the order to deliver chemical agents was authorized.

At about 1400 hours, The HCSO team then deployed two volleys of GAS into the #4 side. Two volleys of 5 rounds went into the #4 side, "A" and "B" windows. After that Volley The Command Post determined that GAS deployment was also needed on the #2 side. Officer Reyna-Sanchez was deployed to the #3 side and assist Deputy Lundie and Deputy Ireland. Lundie and Ireland's radio batteries were going bad. Officer Reyna-Sanchez was tasked with relay the Deputies radio traffic.

The EPD SWAT team was then given the assignment to deploy GAS into the #2 side. Their orders were to deploy 5 volleys of GAS. The team moved to a position that was approximately 81 yards to the North of the #2 side. That was the closest position of cover on the #2 side. As GAS was being deployed, Officer Reyna-Sanchez smelled

the distinct odor of a chemical agent. In between volleys, Officer Reyna-Sanchez could clearly hear HCSO Negotiators attempting to talk [REDACTED] into giving up.

After the volleys into the #2 and #4 sides, Officer Reyna-Sanchez heard "Thumping" sounds coming from inside the residence. According to Reyna-Sanchez, it sounded like "loud footsteps moving fast from the #4 side to the #2 side."

During the deployment of GAS on both the #4 and #2 sides, Officer Reyna-Sanchez could clearly hear the negotiator from HCSO. Reyna-Sanchez was approximately 150-200 yards away from where the negotiators were giving their orders. Reyna-Sanchez could not hear any sounds coming from inside the residence. It was his impression that a reasonable person could have heard the commands / orders that HCSO was giving throughout the incident.

Officer Reyna-Sanchez and his team held on the #2 and #3 sides because HCSO was going to deploy hand canisters into the #4 sides. Officer Reyna-Sanchez heard over the radio that HCSO was going to deploy hand thrown chemical agent canisters. He then observed HCSO deploy the ballistic blanket. The HCSO team then walked up to the #4 side and broke out the #4 side windows. Officer Reyna-Sanchez then heard on the radio the hand canisters were delivered. Officer Reyna-Sanchez observed the CS gas billowing out of the #4 side windows. The smoke was seen for 20-30 seconds. From approximately 50 yards away he heard more "thumping" coming from inside the residence. He believed someone was running around inside the residence. Officer Reyna-Sanchez continued to hear HCSO negotiators attempt negotiations with [REDACTED]. Reyna-Sanchez did not hear any voices coming from the residence. If [REDACTED] attempted to communicate or give up, Reyna-Sanchez could have heard him.

In the second deployment, Officer Reyna-Sanchez observed a white cloud of gas and it lingered for approximately 30 seconds. After approximately 5-10 minutes, officer Reyna-Sanchez observed a slight amount of dark smoke rising up from the #4 side. He then heard some commotion coming from inside the residence. He heard the sound of someone running from the #2 side towards the #4 side. Soon after a big puff of smoke came out of the #4 side "B" Window. The black smoke was different than the smoke he observed earlier. Officer Reyna-Sanchez then heard the HCSO negotiator get on the PA system and advise [REDACTED] that the house. The negotiator told [REDACTED] to leave the residence. Officer Reyna-Sanchez observed smoke start from the #4 side and over the course of 20-30 minutes the smoke turned into fire. The fire was concentrated on the South side and it worked North through the residence. While the fire was spreading, Officer Reyna-Sanchez could still hear movement and pounding in there. After 60 minutes the house was fully involved with Smoke / Fire to the point that the no one could survive. Officer Reyna-Sanchez and his team held their positions the entire time in case [REDACTED] surrendered or needed to be rescued from the residence. Officer Reyna-Sanchez did not hear or see any movement coming from inside the residence during the fire.

1
2
3
4
5
6
7 **INTERVIEW WITH (RODRIGO) REYNA-SANCHEZ**

8 Q=William Honsal

9 Q1=Man

10 A=(Rodrigo) Reyna-Sanchez

11
12
13 Q: I'm interviewing (Rodrigo) Reyna-Sanchez at EPD in CID. Could you spell
14 your last name for the recorded record?

15
16 A: It's R-E-Y-N-A hyphen S-A-N-C-H-E-Z.

17
18 Q: Can you tell us how - how long you have been a police officer?

19
20 A: I've been a police officer with the City of Eureka for about eight years four
21 months, plus or minus a week or two.

22
23 Q: And then how long have you been assigned to the SWAT team?

24
25 A: Approximately five years.

26
27 Q: Okay. And what is your current role on the SWAT team?

28
29 A: I am assistant team leader and I've held that capacity since September of '05.

30
31 Q: Do you have any special training on the SWAT team?

32
33 A: I've ah, gone to the basic ah, SWAT school which is a two week course. I've
34 gone to team leader school, which was a one week course. I've gone to
35 advanced team leader, which was another one week course. I've also been to a
36 week long rappel master course and I'm also in charge of defensive tactics for
37 the SWAT team as well as for the department and ah, a weapons officer.

38
39 Q: Okay. Um, ah, on the - June 3 this last Sunday, did you receive ah, a SWAT
40 call out?

41
42 A: I received a page.

43
44 Q: A page. And what did that page say?
45

- 46 A: Would you like me to read it to you, because it's still on my pager?
47
- 48 Q: Ah just - no. You can just - just summarize it.
49
- 50 A: It was SWAT call out and I was requested to contact ah, Sergeant (Nova) at
51 his residence.
52
- 53 Q: Okay. And you did so, what was the information that was gathered?
54
- 55 A: Well I - I called. I attempted to call Sergeant (Nova) several times. His line
56 was busy. I assumed that everybody else was calling. So I called Dispatch. I
57 said, is this a real call out, and they said yes. And I said, what can you tell me
58 about it. They said it was a barricaded [REDACTED] in Hoopa and they were
59 requesting agency assist from our team. I ultimately contacted Sergeant
60 (Nova) and he gave me the run down on it that we were going to be up there
61 assisting the sheriff's department SET team, holding the ah, outer perimeter
62 and ah, to meet at the PD geared up by 0030 hours.
63
- 64 Q: Okay. So did the ah, entire team respond?
65
- 66 A: The entire team responded, as well as one, two - two patrol, three patrol
67 rifleman.
68
- 69 Q: Okay. And is that team made up of anyone else besides patrol, rifle and
70 SWAT?
71
- 72 A: We have one tactical dispatcher and our tactical commander and right now
73 there is Officer (Wilcox) who is a team leader, myself as assistant team leader,
74 Sergeant (Johnson) who is an operator, (Tim Jones) who is an operator/sniper,
75 (Ronny) Harpham who is our sniper/operator, and then we had ah, (Gary)
76 Cooper as the patrol rifle, (Louis Altic) as a patrol rifle and (Greg Hills),
77 patrol rifle.
78
- 79 Q: Okay, hostage negotiations also if you recall that?
80
- 81 A: Hostage negotiations responded as well. That was (Eddie Wilson) and
82 Sergeant (Houden).
83
- 84 Q: Okay. As a team, all those people you just - just named off, you all responded
85 up to the residence off of [REDACTED] (Hasa) Road and Bloody Camp Road, um...
86
- 87 A: Correct.
88
- 89 Q: I mean just - just north of Hoopa.
90

91 A: Correct.

92

93 Q: Okay. Um, what time did you guys arrive on scene approximately?

94

95 A: Ah, probably about quarter to 3:00 in the morning.

96

97 Q: Okay. So when you arrived on scene, um, ah, what did you do? Was there

98 any directives? Did you take part in any planning?

99

100 A: We - Sergeant (Nova), Officer (Wilcox) and myself went into the sheriff's

101 department's tactical communications center.

102

103 Q: Mm-hmm.

104

105 A: And met with Lieutenant (Kaminta) and Sergeant (Quenell). They briefed us

106 on what had transpired up to that point. They showed us essentially a rough

107 sketch of the same sketch that you've got here on a dry erase board. They

108 showed us the position of the teams that they had in place. They showed us

109 positions of vehicles. Um, they pretty much told us where they wanted us to

110 be and then from there we formed up our teams and three different elements --

111 a two man team, a four man team and another two man team.

112

113 Q: Okay. Did you guys discuss rules of engagement at that point?

114

115 A: We asked ah, Lieutenant (Kaminta) specifically what his rules of engagement

116 were. His response, and I quote was, respond to the threat or react to the

117 threat. React to the threat.

118

119 Q: So what did that mean to you?

120

121 A: What that meant to me was based on the fact that the [REDACTED] had fired on

122 them several times by that point, and it was explained to us if he pointed a

123 weapon out the window, we were going to return fire. He - he came out of the

124 residence weapon in hand and failed to comply with our orders, we were to

125 return fire. If he came out without a weapon, we were going to give him

126 commands and hopefully try to take him into custody.

127

128 Q: Good deal. So tell - tell ah, tell us where you first deployed and who were

129 you deployed with.

130

131 A: I was teamed up with Officer (Altic). The other six members of the team were

132 inserted probably about an hour before we were. Ah, it was about ten after

133 4:00 in the morning when we were finally escorted, I can't tell you which

134 operator took us up, but we were escorted to the number three side. We were

135 told we were going to come from number three side from an elevated little

136 ridge line. Ah, we were escorted up there by one of their SWAT team
137 members and we replaced two other people that had been in place from an
138 unknown time prior to our arrival. We took up a position and were there until
139 probably about daybreak and at which point I recognized that our position had
140 no cover. I left Officer (Altic) in place to cover number three side while I
141 made my way to a different position and found small trees that afforded us a
142 little bit more cover other than just tall grass. Right around 6:00 in the
143 morning we made our way to that position, ah, bumping from one position to
144 the other, covering and moving, and made our way to that position up a hill.
145 It probably put us out about 70 yards and probably another 30 feet higher than
146 our original position.

147
148 Q: Can you mark that position with number two roughly?

149
150 A: All right, I would say somewhere right around here.

151
152 Q: Okay. Um, getting back a little bit, when we first responded to position
153 number one, do you remember the officers that you replaced, the deputies?

154
155 A: I want to say it was (Ireland) and (Lunde) because there are the ones who
156 ultimately replaced us and they had - we had talked about yeah, they had been
157 there earlier that night

158
159 Q: Okay. Okay, ah, getting back to position number one, you were there
160 primarily throughout the night until you discovered that when daybreak struck
161 you didn't have cover so you decided to move.

162
163 A: We moved.

164
165 Q: On the number three side, did you see anything, um, that indicated there was
166 someone inside of that trailer?

167
168 A: Probably about half an hour to 45 minutes after we got there we saw
169 movement in what we called the number three side A window. There was ah,
170 the lights were on inside. We were hearing what we described as thumping
171 sounds, as if somebody was moving inside. Ah, we saw some movement at
172 the window. We radioed that we were seeing movement at that window. I
173 could see a [REDACTED] I couldn't tell you if it was male or female. I was
174 equipped with a small pair of binoculars and I could see him probably from
175 the neck to the waist. He appeared to be wearing a white tee shirt or she was
176 wearing a white tee shirt. And the light went out and we heard movement
177 from the number four side towards the number two side.

178
179 Q: Can you draw on the number three side any windows, doors that you might
180 have saw the [REDACTED] at?

181
182 A: Just the ones that I saw him at?
183
184 Q: Um, you can draw all the windows in that you know that were there, and then
185 indicate on there um, you can label from left to right A, B and C or however
186 you want to do it there.
187
188 A: Okay. A and B were windows and C was the door.
189
190 Q: Okay. And you said sometime during the night you saw some movement by a
191 [REDACTED] inside.
192
193 A: Correct. At window A.
194
195 Q: Window A. And getting back to you saw light coming from window A.
196
197 A: The lights were on when we arrived on scene, probably around 5:00, 5:30.
198 They were turned on.
199
200 Q: Okay. Now these lights, would you classify or clarify them as electric light,
201 bright lights? Was it candle lights, (unintelligible) light?
202
203 A: Interior room light, just a standard interior light.
204
205 Q: Okay.
206
207 A: It wasn't bright or amplified or flickering. It was just a light.
208
209 Q: Okay, a light.
210
211 Q1: Could you tell if that light was coming from the ceiling or was it a lamp on?
212
213 A: I couldn't tell where it was coming form, but it did - he had some sort of
214 covering on the window. And I could see through the binoculars that the
215 screen was damaged. So it limited my view into the room to the point where I
216 couldn't tell if it was, you know, the light was coming from the floor or from
217 the ceiling. But I know that it wasn't a candle. It wasn't flickering. And when
218 it went off it went off 100%.
219
220 Q: Okay. Got you. Um, the ah, the climate that night, can you describe the
221 weather?
222
223 A: It was ah, cold and it was ah, sprinkling to the point where we got a steady
224 rain there for a short portion of time in the morning. And ah, when we were

225 finally relieved by around ah, I want to say about 8:30, it had started drizzling
226 but it kind of was off and on.
227

228 Q: Okay. During the night ah, was there moonlight? Was it...
229

230 A: It was almost a full moon.
231

232 Q: Almost a full moon. So when the moon did shine, um, it - you could see three
233 side fairly well?
234

235 A: Correct.
236

237 Q: And did you have night vision goggles at all?
238

239 A: We did have two sets of night vision goggles. I don't know the specific model
240 but it would be a two to one. They had infrared capabilities however we
241 didn't use them. We didn't know if he had infrared capabilities so we didn't
242 want to give away our position so we just stayed strictly with the night vision.
243

244 Q: And um, could you - could you hear anything from the inside? Was there
245 anyone, any voices that you heard coming from inside?
246

247 A: No. Ah, when we saw - when we saw him here at this window, other team
248 members saw him and we heard on the radio that he appeared to be taking his
249 clothing off, he appeared to be moving around, amplified or animated
250 movements. Um, that was something I just saw glimpses of. I didn't have
251 obviously didn't have the view that the people on the number four side did.
252 But I didn't - that's one thing that we never heard. I never heard him speak or
253 yell or curse. We just heard that thumping sound that sounded like it went
254 from the number four side towards number two side repeatedly.
255

256 Q: Any televisions, any music, anything like that?
257

258 A: No, not from the number three side.
259

260 Q: If someone wanted to give up on that side and was yelling for help or yelling
261 that he wanted to give up inside that trailer, ah, could you have heard him
262 from your position?
263

264 A: I believe I could, yes.
265

266 Q: Yes. Um, so getting back to daybreak, you move positions to number two.
267

268 A: Right.
269

270 Q: Um, and you were about how many yards away at that point?
271
272 A: Made it about 70 yards.
273
274 Q: Seventy yards.
275
276 A: That was just a visual estimation. I believe this was about 50 and we moved
277 back about 20 yards and further north, and probably about 30 feet more
278 elevation.
279
280 Q: And you were there for a couple hours in that position?
281
282 A: We were probably there from about 6 o'clock to about 8:30.
283
284 Q: During that time did you see any movement? Did you see anything coming
285 from inside?
286
287 A: No.
288
289 Q: Anything to indicate that the [REDACTED] was inside?
290
291 A: No.
292
293 Q: Okay. No more thumping sounds?
294
295 A: No.
296
297 Q: Okay. Ah, about 8:30, what happened?
298
299 A: Ah, the sheriff's department team comprised of Deputy (Ireland) and Deputy
300 (Lunde) moved back into our position,, number one, and I specifically
301 remember that because I actually text paged our dispatcher saying, you know,
302 what the fuck, we got two guys moved into our number one spot and nobody
303 ever told us they were en route. So I was kind of upset about the fact that here
304 I got two people, two unknowns coming into my area and nobody is telling
305 me that, you know, we're coming in.
306
307 Q: Right.
308
309 A: So they moved back into our number one spot after I saw that they had - they
310 had that side covered, Officer (Altic) and I made our way back around and
311 ultimately came back down to our command vehicle.
312
313 Q: Um, at that point, ah, at the command vehicle, um, ah, what were you - what
314 was your next course of action?

315
316 A: Next course of action as Sergeant (Nova) said, take your gear off, have some
317 coffee. There's some donuts over there. Get some rest if you want it. I saw
318 several of the other people had found a spot to lay down in and were sleeping
319 or resting. I decided to load up on coffee and stay awake. Ah, probably about
320 9:30 or 10:00 we were told to gear back up, we're going back in.
321
322 Q: Okay. What were the orders then when you went back in?
323
324 A: They were going to deploy gas.
325
326 Q: Deploy gas.
327
328 A: They had ah, attempted to negotiate at various points using the PA system.
329 Negotiations weren't working. Sergeant (Nova) came over and said the
330 negotiations aren't working, they're going to deploy gas. Gear up. So we
331 probably had about an hour, hour and a half of down time that we just -
332 everybody geared back up. I woke up the guys who were sleeping and we got
333 our assignments again and we prepped for gas delivery.
334
335 Q: Um, and where did you - where were you guys deployed initially in the gas
336 (unintelligible)?
337
338 A: We made our way from where the command vehicles were to this point here.
339
340 Q: Mm-hmm.
341
342 A: The plan was that the sheriff's department's primary team was going to deliver
343 I believe two volleys of gas into the number four side. Our team ah, was
344 going to deliver a follow-up volley into the number four side. That was about
345 11:30. And then we were told to stand down because they were going to try
346 to get a medivac in in case they needed it, and we were told it was going to be
347 about an hour to get it.
348
349 Q: Okay. So from 11:30 to about 12:30 you guys were ready to go but were
350 standing by.
351
352 A: We sat right here next to these patrol cars and just...
353
354 Q: Can you mark that with number three? As you're waiting for the helicopter, as
355 you're in that position, you're close enough that you can see the place on the
356 number four side?
357
358 A: I - I had a ah, maybe the view of maybe this portion of it right here. I never
359 made my way past this point. The sheriff's department's team was up there

360 doing stuff. I didn't want to interfere with them so we just pretty much stayed
361 back there.

362
363 Q: And did you see any movement, anything coming from the inside?

364
365 A: No.

366
367 Q: Nothing to indicate that the [REDACTED] as wanting to give up at that point?

368
369 A: No.

370
371 Q: Okay. Ah, so what time did ah, the gas delivery start?

372
373 A: Sometime in the afternoon, probably close to 2 o'clock. Um, at one point ah,
374 Sergeant (Quenell) came back to - to our team back here and said - asked who
375 had been up here at the number one spot. And I advised him that I had been
376 up there and Officer (Altic) had been up there. And he asked that one of us go
377 back up there because the two deputies that were up there had - their batteries
378 had died in their portable sand they needed - they needed to have radio comm
379 with them. Since Officer (Altic) is also cross trained as our gas delivery guy,
380 I couldn't send him up there. So I took it upon myself to go up there. I ended
381 up coming back up here to the number one spot with Deputy (Lunde) and
382 Deputy (Ireland) and just relayed radio information to the best of my abilities,
383 because our radio comms were just in and out.

384
385 Q: Okay. So you were there. Can you mark that again with number four, the
386 number one there, as the fourth spot you chose. And so your primary function
387 at that point was to - to assist (Lunde) and (Ireland) um, and to cover the
388 number three side?

389
390 A: Correct, at which point I had my rifle with me. I had my rifle with me the
391 entire time. And ah, when they needed a break I covered that side and let
392 them roll over on their back and stretch their legs and when they came back
393 up on target I just stood down.

394
395 Q: Any observations on the number three side? Were windows open at all?
396 Doors open?

397
398 A: They hadn't changed since I had left earlier that morning.

399
400 Q: Okay. Um, what happened next? What are your observations after that, after
401 2 o'clock?

402
403 A: They started deploying gas.

404

- 405 Q: Where was gas first deployed and by who? By what team?
406
- 407 A: Sheriff's - the sheriff's department delivered gas into the ah, number four side
408 as I recall that they said two volleys five each. Two volleys five each into
409 each window A and window B on the number four side. So they delivered
410 five and five, five and five.
411
- 412 Q: Okay. Um, and was there any action by the [REDACTED] after those volleys entered
413 the house?
414
- 415 A: They started out by the - I think it was Sergeant (Fridley), who was their
416 primary negotiator, would blip the siren and then start talking to him on the
417 PA system. Initially he told him he had 25 minutes. After 25 minutes, no
418 response. That I believe was brought down to 10 minutes the second time, no
419 response. And after the third time they definitely started delivering the gas.
420
- 421 Q: Okay. And ah, ah, given your position right there, if the [REDACTED] wanted to
422 give up at that point, were you able to um, to ah, perform a apprehension ah, if
423 he would decide to come out of the C door?
424
- 425 A: Yes.
426
- 427 Q: Were you close enough that you could have seen that door open?
428
- 429 A: Yes. We had a prefect view of all three of these openings here. And had he
430 chosen to come out of this door, this area right here which is somewhat open,
431 there was a pile of cars and stuff like that, but one of us, one of the three of us
432 would have definitely been able to shout commands to him to come into this
433 area here and comply with our orders to surrender.
434
- 435 Q: Did that door ever open up?
436
- 437 A: Never opened.
438
- 439 Q: Okay. Um, at some point um, ah, did - was there more gas entered into that
440 residence?
441
- 442 A: They - their team deployed gas. Our team deployed gas. They worked their
443 way around the building. I know that at some point, our team delivered gas
444 into the number two side.
445
- 446 Q: Okay.
447
- 448 A: They ultimately made their way up to somewhere out in here.
449

450 Q: Mm-hmm.
451
452 A: It was probably about a 81 yard shot. They delivered gas into this area,
453 worked their way ultimately to this spot, and I believe they delivered gas - I
454 know they delivered gas into the number three shot - into the number three
455 side. They delivered into the A window and B window.
456
457 Q: So when they delivered gas, they put ah, rounds through the window, through
458 the residence, gas rounds.
459
460 A: Correct.
461
462 Q: And did you see any smoke that came from those rounds?
463
464 A: Not from those rounds, no.
465
466 Q: Okay. Did you see anything different as far as the air or atmosphere or
467 anything like that,
468
469 A: We were able...
470
471 Q: Indicating the gas was taking effect.
472
473 A: We were able to smell gas, because when they fired them over the top of our
474 heads essentially...
475
476 Q: Mm-hmm.
477
478 A: The deputies masked up. I just buried my face in the round and just dealt with
479 it. But they actually masked up. We were getting from the residual from as it
480 was wafting up out of the building, or just the residual as the rounds were
481 being sent down range. But we were definitely smelling gas.
482
483 Q: Do you recall um, which direction the wind was blowing at that point?
484
485 A: The wind was blowing - at that point it was blowing south, because it was
486 coming from my right side.
487
488 Q: Okay. But you could smell the gas?
489
490 A: Yes.
491
492 Q: And you've had experience with gas before?
493
494 A: Correct.

495
496 Q: Okay. Ah, so the volleys of gas have been delivered um, from I guess three
497 sides now -- number four side, number two and number three. At any time
498 did - did the [REDACTED] attempt to give up?
499
500 A: No they - they tried negotiating with him between volleys. And they never
501 got a response.
502
503 Q: No response.
504
505 A: No, we were able to hear thumping and movement inside and at one point I
506 told them if they - that we were hearing a lot of thumping sounds from this
507 two, three corner. Whatever was going on I don't know. But it just sounded
508 like to me that somebody in there was running to the number four side back to
509 the number two side and back in forth in there. You could just - just like if I
510 put, you know, loud footsteps moving fast.
511
512 Q: Okay. So um, so what time was that? If you can recall. The gas started being
513 deployed around 2:00-ish.
514
515 A: I'd want to say probably about an hour into it.
516
517 Q: Okay. So you still heard movement about an hour into it?
518
519 A: Yes.
520
521 Q: Okay. Um, at some point, um, ah, gas volleys were stopped being delivered
522 from the 37 millimeters.
523
524 A: Yes.
525
526 Q: Okay. Um, did you see gas being deployed any other way?
527
528 A: Once our team was up here the sheriff's department delivered more gas from
529 the number four side with a 12 gauge - 12 gauge (unintelligible) round. Ah,
530 somewhere between 15 and 20.
531
532 Q: Okay.
533
534 A: And they were discussing on the radio the next course of action. I remember
535 Lieutenant (Kaminta) speaking with ah, Sergeant (Quenell) and they were
536 asking if they had any pyrotechnic devices, pyrotechnic CS rounds. They -
537 and the feasibility of inserting those canister rounds or those grenades for lack
538 of a better team into the A or B window. Um, I don't recall what Sergeant

539 (Quenell's) words were exactly, but he said that it was doable but not the
540 safest it could have been, I guess.
541
542 Q: Okay. And that was over the radio?
543
544 A: That was over the radio.
545
546 Q: Okay. Um, and then at some point were there ah, hand ah, hand thrown CS?
547
548 A: Yes.
549
550 Q: Gas inserted into the residence?
551
552 A: Yes.
553
554 Q: Okay, by who, or by what team?
555
556 A: The sheriff's department used ah, ballistic blanket and a pike pole that was ah,
557 brought up to them by the CDC team. They advanced here, team of four I
558 believe. Ah, broke these windows out or knocked the glass out. They had
559 already been broken by the 37 millimeter rounds. They pulled all the glass
560 out, ah, moved up and I kept - my view was limited, but I could see the team
561 moving up and then they - I heard on the radio that the gas had been deployed.
562 I also heard them say that they saw a large caliber handgun just inside this A
563 window somewhere on a shelf or something. They moved over here and
564 threw a handheld device into this window as well, at least - at least one in
565 each window that I could see.
566
567 Q: At that point when they ah, inserted the devices, did you see anything coming
568 from inside the house?
569
570 A: There was the - the ah, CS gas was billowing out of the windows.
571
572 Q: Okay. So this is at one point you could actually see the - the - the gas being
573 discharged inside and deploying. And how long - do you know how long the
574 discharge occurred or?
575
576 A: Probably about 20 to 30 seconds before it kind of dissipated, at which we
577 point we were - we were again hearing that thumping sound back and forth
578 and there was - somebody was moving around in there.
579
580 Q: Okay.
581
582 A: And they were again, trying to negotiate with him via the PA system and they
583 never got a response. To my knowledge they never got a response.

584
585 Q: So after the handhelds were thrown, you still heard that thumping of someone
586 running inside.
587
588 A: Yes.
589
590 Q: And ah, you were in that number four position.
591
592 A: Yes.
593
594 Q: And I don't know if we covered it. How many yards were you away were you
595 in that position?
596
597 A: About 50 yards.
598
599 Q: Fifty yards. Okay. And ah, despite the smoke, despite everything, did you
600 see anyone come out of the A, B or C opening on the number three side.
601
602 A: No.
603
604 Q: That wanted to surrender?
605
606 A: No.
607
608 Q: Despite all the commotion, could you have heard someone on the inside that
609 wanted to give up? If someone was screaming for help, I give up, could you
610 have heard them from that distance?
611
612 A: Yes.
613
614 Q: And did you hear any of that stuff?
615
616 A: No.
617
618 Q: Okay. Um, did the CS gas dissipate?
619
620 A: It did.
621
622 Q: And did anything happen after that gas dissipated?
623
624 A: They - they were - they were trying to negotiate with them. They were
625 prepping for another delivery of hand held into these A B windows on the
626 number four side at which point I told these guys, it's going to get nasty out
627 here. We need to move. So the three of us communicated with the team that
628 was up here. They covered us. They took us, you know, covered the number

629 three side. We ended up rolling off to the side here behind the brush. There
630 was a lot of brush right here. Rolled off to the side, made our way up the back
631 side and ended up coming back up here to the - to our number two spot.
632

633 Q: Did you have a clear line of sight then to all the openings on the number two
634 side?

635
636 A: Yes, still had a clear line of sight.
637

638 Q: When you said it's going to get nasty, um, were you referring to the amount of
639 gas that was being deployed?

640
641 A: The amount of gas, yeah.
642

643 Q: And did you smell again the gas?

644
645 A: Yes.
646

647 Q: Okay. And was it affecting you in the position 50 yards away?

648
649 A: It was. I - I could smell it.
650

651 Q: From the handhelds?

652
653 A: Yeah. I - I could smell it and I knew that it was from the handheld because by
654 that time they had already fired the all the 37 millimeters. So it was definitely
655 - the stuff they fired from the 37 millimeters you couldn't really see it. But
656 this stuff that went in from the hand held you could - you could see the smoke.
657 Okay, or whatever you know, the carrier agent is on that.
658

659 Q: Yeah.
660

661 A: Um, so we made our way back up to here. Ah, actually probably like
662 somewhere off of here. We didn't actually come down to their spot. But we
663 worked our way up there and took up another position that allowed us to view
664 still - we're probably - this is probably 70 yards, so we're probably about
665 maybe 90 - 90 yards out and that's an elevated position. But we could still see
666 the A, B and C door.
667

668 Q: Okay.
669

670 A: There was a pile of something right about here. It looked like a wood pile or
671 something covered with a tarp that I could still see from up there.
672

673 Q: Okay. Um, did you see them deploy the ah, you said they were going to go
674 again on the handhelds.
675

676 A: Yes.
677

678 Q: Did they deploy?
679

680 A: They did.
681

682 Q: Okay. And where did you see them deploy the second volley of handhelds?
683

684 A: I'm - I'm assuming - I heard them deploying something. I assumed it was the
685 A window.
686

687 Q: Okay.
688

689 A: And then when they got to he B window I could see them. They moved up
690 there again using the ballistic blanket and the yellow pike pole. They
691 advanced up there and delivered the gas again
692

693 Q: Did you see - was it the same effect, same kind of smoke?
694

695 A: The same kind of white smoke and it probably lingered for by that time maybe
696 30 to 40 seconds before it dissipated, and then it was just - it just kind of all
697 dissipated. And we were still talking - we were talking about it. And then
698 what I noticed was darker colored smoke coming from inside. It was kind of
699 just coming up right from the roof line and I mentioned to Deputy (Lunde)
700 that's - that's a fire.
701

702 Q: Okay.
703

704 A: And it ah, it just started building in intensity.
705

706 Q1: About how long after they deployed that second handheld canister, um, you
707 said it lasted for 30 to 40 seconds and then you started seeing black smoke?
708

709 A: It just - there was like - there was just faint wisps of smoke, the CS smoke.
710 And ah, we heard some commotion and it sounded like again like the -
711 somebody running from the number two towards number four side, and it
712 sounded like there was some sort of commotion here in the number four area.
713 And then it sounded like it was going back towards number two, and then just
714 like a big puff of smoke came out the - out the um, window B, and then that
715 trickle of darker smoke started coming out.
716

717 Q: So when you say puff of smoke, was that different than the cloud that the CS
718 gas?
719

720 A: Yeah, because the CS gas had dissipated by that point and was just kind of
721 wafting up off of the roof line. So between the time the CS gas dissipated
722 there was commotion inside but then just a - just like a puff of smoke just
723 came out the window. And then the movement went back, and then you could
724 start seeing the dark smoke coming out.
725

726 Q: Um, and you said the darker smoke started um, and you could see from the
727 ridge - from the roof line?
728

729 A: Correct. And by that time the - the wind direction had change and it started to
730 go back towards us. And I could definitely smell that it was smell of wood
731 and kind of you know, building materials. Ah...
732

733 Q: Burning. Definitely not the CS.
734

735 A: Not CS gas. I mean it was definitely something burning, something, you
736 know, carpet, drapes, something. It wasn't, you know, wooden smell. It was
737 just some sort of manmade material or something.
738

739 Q: Okay. At that time did you hear any announcements being made?
740

741 A: Ah the - the negotiator was telling him, ah, I think your house is on fire, you
742 need to come out. I think your house is on fire. You need to come out. And
743 we were up there talking saying there is no I think your house is on fire, it's on
744 fire. I mean the general consensus was that the house was on fire. And at that
745 point it was - we weren't seeing flames, we weren't hearing anything crackle.
746 It was just that gradually increasing plume of smoke coming out of this
747 number four side.
748

749 Q: So you were approximately 90 yards away.
750

751 A: Yes.
752

753 Q: On the two three corner?
754

755 A: Ah, yeah.
756

757 Q: Okay. And estimate your distance then from um, your position to where the
758 negotiations were occurring.
759

760 A: Probably less than 100 yards.
761

762 Q: Okay. Hundred yards. So you're 100 yards away. And was it a clear line of
763 sight from?
764

765 A: I couldn't see him.
766

767 Q: Okay, you couldn't see him.
768

769 A: No.
770

771 Q: How clearly could you hear the orders being given from the negotiator?
772

773 A: Oh I could - I could hear them, because they - they preceded all of the orders
774 with a siren so they would blip the siren every time, and then you could hear
775 Sergeant (Fridley) saying, you know, we think your house is on fire, you need
776 to come out, you need to come out. It's not a big deal. We can work this out.
777 We need you to come out. You know, we need to resolve this. I mean he
778 repeated that over and over, and he repeatedly told him, you know, we think
779 your house is on fire. We think your house is on fire. You know, we think
780 the house is on fire. And again, like I said, we were up there saying I don't
781 think it's on fire, I know it's on fire.
782

783 Q: You think that it was reasonable, um, as far as how loud the PA was for
784 someone to have heard it inside?
785

786 A: Oh yeah.
787

788 Q: And since there was no TV, no loud music being played, um, reasonably the
789 [REDACTED] could have heard the announcements?
790

791 A: Yes.
792

793 Q: And at that point did you see any movement out of the A, B or C openings on
794 number three side?
795

796 A: No.
797

798 Q: And were you in a position where if someone wanted to give up and be
799 rescued, could you have rescued that person?
800

801 A: Yes. My - my focus at this point when I was up here was this door here. I - I
802 told - I told myself and I told the other two ah, Deputy (Lunde) - by this time
803 Deputy (Ireland) had taken up another position because he had the scoped
804 rifle. But I told him, I'm watching that door. That's where my focus was was
805 on that door. I still had these other two openings in my peripheral vision, but
806 when I brought my weapon up and looked through the sight, that was my

807 primary focus. I knew if he's coming out he's going to be coming out that
808 door.

809
810 Q: Mm-hmm.

811
812 A: Especially since I had heard him - heard movement back in this corner, so
813 there is no way - there is no reason why he would run all the way to here when
814 he can just come out that door.

815
816 Q: So this - this fire is occurring on the number four side. And you last believe
817 the [REDACTED] was running towards the number two side?

818
819 A: Yes, correct.

820
821 Q: Um, how long did it take for this fire actually - actually the smoke to produce
822 fire being seen on your - from your position, estimating.?

823
824 A: The smoke built and built and built and got more intense probably for about
825 20 to 30 minutes before we started seeing flames and we started seeing flames
826 here at the A opening.

827
828 Q: Okay. When you started seeing flames out of the A opening number three
829 side, um, was the - I guess northern half or the number two side, was that
830 engulfed with flames at that point?

831
832 A: No, the fire worked its way from the number four side back towards the
833 number two side.

834
835 Q: Did you see smoke billowing out of the number two window once you started
836 seeing flame from the number four side?

837
838 A: No, the smoke like I said was coming out here out of the A and B window on
839 the number four side and the roof line. And it slowly worked its way from the
840 number four side towards the number two side. We started seeing flames
841 coming out and smoke coming out from the number three A window, and then
842 you could see smoke start to come out of the B window. And it - it's - you
843 could watch the fire on the roof line moving along. And it was coming out -
844 the smoke was coming out of the eaves and then the flame and smoke started
845 coming out of the B side. And then ultimately smoke was coming out around
846 the edge of the door, top, bottom and both sides. I could - I could see smoke.
847 The wind changed and this whole side, it was just engulfed in smoke.

848
849 Q: Mm-hmm.

850

851 A: And we could still hear movement and pounding in here. I actually thought
852 he was probably - in my opinion I thought he was probably trying to chop his
853 way through the floor or something to get out of there. They were still giving
854 him commands. It was no longer I think your house is on fire. It was, the
855 house is on fire. You need to come out.

856
857 Q: And what was the sound like um, there at the residence there at that point?

858

859 A: It was a roaring fire.

860

861 Q: It was a roaring fire. So there was cracking, I mean what?

862

863 A: Yes, there was crackling of the fire. Ah, the glass was breaking. I don't know
864 - obviously I didn't have the line of sight on the number one side. But I could
865 hear gas breaking. I heard other people saying, I know Officer Harpham and
866 Cooper and Sergeant (Johnson) were somewhere up here. I - I think I heard
867 them say 120 yards out. And I could hear Officer Harpham saying repeatedly
868 that he was still not getting any smoke out of the one two side.

869

870 Q: Okay. Um, so at any point um, or how long did it take in your estimation
871 from the fire to - fire and smoke to fully engulf that residence to the point
872 where if anyone was inside it would be unsurvivable?

873

874 A: I think it - it went from the moment I saw the fire and knew it was on fire to
875 the moment the fire department moved in, it was probably just under an hour
876 in my opinion.

877

878 Q: Okay. And ah, did you stay and watch that number three side, all those
879 openings that entire hour?

880

881 A: Yes.

882

883 Q: Okay. Was there any movement? Was there any indication that the [REDACTED]
884 wanted to give up?

885

886 A: No. We - he wasn't - we couldn't hear any talking or yelling or gagging or
887 anything. We did hear - once that fire had got to past B window and where I
888 could see smoke coming out of the - the edges of the door here, the C door,
889 we could hear what I believe was small caliber ah, rounds detonating. And
890 that started. I mean they were just pop pop, pop pop, just ah...

891

892 Q: At that point did you believe you were being shot at?

893

894 A: I didn't believe we were being shot at no.

895

- 896 Q: What were you attributing those pos to?
897
- 898 A: Well we had been told originally that he had a .22 caliber, access to a .22
899 caliber rifle and about 400 rounds was the information we were given initially.
900 We were told he had ah, a scoped .22 rifle with about 400 rounds. We were
901 told he had an AR15 with two 20 round mags, um, some sort of large caliber
902 handgun, unknown how many rounds. We were told he had ah, an AK47 in a
903 safe, but that there was no ammo for that. So when I heard all those popping
904 sounds I attributed them to being .22 caliber rounds going off due to the heat
905 and the flames from the fire. Um, as the fire progressed towards this point
906 and it was - I mean it was totally covered. You know, it was totally covered
907 from the number four side all the way back toward the door, the entire roof
908 was just, I mean flames. And we heard pop pop pop pop pop and then one
909 louder what I thought was a shot. And I actually commented after that, I think
910 he shot himself. That was my - that's what I believed at the time that these
911 were just cooking off, the smaller sound that we were hearing were rounds
912 being cooked off and then that final one was him shooting himself.
913
- 914 Q: Okay. So um, by this time an hour into it, flames, heat, ah, smoke has filled
915 that ah, that entire residence and then Fire was actually called in.
916
- 917 A: Yes. This - this door never caught on fire. The fire probably came right about
918 to here before they moved in. Okay, this door although smoke was coming
919 out around the edges, was never on fire on the exterior. I can't say what it was
920 like in the interior. But I never saw the paint bubbling or anything like that on
921 the exterior of that door. And I still up to the point where after we heard that
922 loud boom, I still expected him to run out that door.
923
- 924 Q: Mm-hmm.
925
- 926 A: I said, if he's going to come out, he's going to come out that door. I had
927 abandoned even looking at this window or this window because in my
928 opinion, there was no way he would go back into that fire to try to make it out
929 those openings. I said, if he's coming out, he's going to come out either out
930 this door or somewhere out this side.
931
- 932 Q: And there was no indication that he wanted to give up?
933
- 934 A: There was no indication. Like I said, we lost visibility. The entire team up
935 here lost visibility due to this whole thing being engulfed in smoke, and then
936 the wind would shift and blow he smoke off in the other direction. But a
937 couple of times there, two or three times, we just lost total visibility to this
938 house. It was all just engulfed in smoke.
939

- 940 Q: So what time did you stand down? Did you finally um, demob from here and
941 why?
942
- 943 A: We - we ended up moving the team when we were no longer of any value
944 here and the fire department was moving in and they were coming up with the
945 CDC team was coming up to provide cover for them. They were just a - it
946 was just a major crossfire coming in. And I told my guys, I got a page ah,
947 from ah, from our dispatcher telling me that Sergeant (Nova) had ordered us
948 to stand down. So I told everybody, I said, you know what, we've got orders
949 to stand down. We're not doing any - anybody any good up here. We're
950 going to move. So half the team moved back this way. I actually walked
951 down with Deputy (Lunde) all the way down to a fence line here. We jumped
952 the fence and I actually stood somewhere right in here watching them put the
953 fire out.
954
- 955 Q: So you were on the number one two corner and watching the fire.
956
- 957 A: Yes.
958
- 959 Q: Okay. And ah, so ah, to the best of your knowledge, you never heard voices,
960 you never heard anyone besides the negotiations attempt to give up?
961
- 962 A: No. And that was something that we repeatedly talked about. It's like, he's
963 not coming out. I mean because he wasn't - we didn't know if he had a gas
964 mask or anything like that. But he - there was no coughing sounds, no
965 gagging sounds, no - no screams, no nothing that we heard.
966
- 967 Q: Okay.
968
- 969 A: Just that - just that pounding sound, whatever it is that he was doing inside,
970 whether it was just loud footsteps or - there was loud footsteps and then there
971 was pounding on something. What he was doing, I don't know. That's when I
972 thought he was probably trying to chop a hole through the floor. That's what I
973 thought.
974
- 975 Q: At any time did you observe ah, or did you yourself discharge your firearm at
976 the residence?
977
- 978 A: No.
979
- 980 Q: Ah, and then where did you - once - once you were ordered to um, to
981 evacuate, where did you respond to at that point?
982
- 983 A: I ended up walking down this road. By - by the time I got here the sheriff's
984 department evidence team was marking stuff, circling stuff with paint. I

985 walked along this edge of the road and ended up making my way back in here
986 and started taking my gear off.

987
988 Q: Okay. Um...

989
990 A: I think I saw you somewhere in here on my way back.

991
992 Q: That's right. Right there. Um, anything else (Kevin)?

993
994 Q1: So at no time you fired your weapon?

995
996 A: No

997
998 Q1: Did you hear or see any other officer, be it EPD, sheriff's department, Pelican
999 Bay, ah, any police officer fire their weapon?

1000
1001 A: No.

1002
1003 Q1: Did you hear the [REDACTED] fire at anybody at the time you were there?

1004
1005 A: No.

1006
1007 Q: Okay, do you have any questions? Anything else to add on this?

1008
1009 A: No I - it's an unfortunate situation. I'm glad nobody was hurt, I mean. He
1010 chose to be where he was.

1011
1012 Q: Got you. Okay. That's the end of the interview. It's ten after 10:00.

1013
1014
1015 This transcript has been reviewed with the audio recording submitted and it is an accurate
1016 transcription.

1017 Signed _____

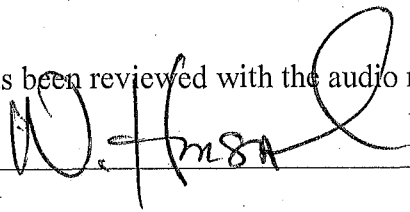

HUMBOLDT COUNTY SHERIFF'S DEPARTMENT

CASE: 200703162

INTERVIEWER: Rich Schlesiger, Detective

[REDACTED]
STATEMENT OF: [REDACTED]

DATE & TIME: June 3, 2007 @ 1845 hrs.

LOCATION: Hoopa, California

ALSO PRESENT:

RS Rich Schlesiger
[REDACTED] [REDACTED]

[REDACTED] (Inaudible).

RS Okay.

[REDACTED] Apparently I heard he hasn't been taking it and,

RS Okay, sir what's your, let me get the date here, June third (3rd) two thousand and seven (2007), time eighteen forty five (1845). What's your first name?

[REDACTED] Richard.

RS What's your middle name?

[REDACTED] Middle name, [REDACTED]

RS You go by [REDACTED]

[REDACTED] [REDACTED]
RS. [REDACTED]

[REDACTED] Yeah. [REDACTED]

RS Okay. And, and with [REDACTED] uh it sounds like uh he, from what I heard, [REDACTED] a few days ago?

[REDACTED] I guess.

RS Okay.

[REDACTED] That's what I heard I mean, (inaudible) say I mean she doesn't, we've been back in ninety five (95) ninety six (96) divorced I mean for quite a while and uh she doesn't really include me with what's going on.

RS Okay.

[REDACTED] You know, she's basically, we divorced, [REDACTED] was in like in the eighth (8th) grade and you know try to turn all my kids against me, I mean, natural, normal,

RS Okay.

[REDACTED] You know divorce thing from there he went from bad to worst and,

RS When, when's the last time you talked with [REDACTED]

[REDACTED] I talked to [REDACTED] you know I was trying to think of that on the way up, maybe about a week ago.

RS Okay how was he then?

[REDACTED] Uh I, I don't know if this was the last time, but the time I seen him he was with that guy up there in the car, [REDACTED] and he's not a very good character,

RS No.

[REDACTED] In my opinion.

RS I know who you're talking about.

[REDACTED] You know, anyway he was standing over at the seventy six (76) station and he had a lunch pail on his hand and I was pulling out, he said "oh what's up pop" or something like that, I said just getting some lunch, he said I got my lunch right here, tuna, it's like man [REDACTED] you know I thought to myself, come on son you know.

RS And you mentioned something, he wasn't looking good?

■ No he was looking all scraggly whiskers, last time I seen him and he's lost a lot of weight, you know and he's got uh went recently got a part of a big tattoo on his chest and he knows that you know (inaudible) big tattoo's on him and he knows I don't care for it.

RS What about, okay, ■

■ What do you mean, do he do them?

RS Yeah.

■ I'm sure he does them.

RS What kind?

■ Probably ■

RS Okay. What makes you think that's what he does?

■ Uh I don't know, just cause uh, just kind of weird I mean I don't know if it's that or not taking ■ or I mean, and I haven't seen him do it, I see,

RS You just suspected it?

■ Yeah I mean I've did it before I mean

RS Mm hmm.

■ And I know,

RS And you realize what ■

■ Well I don't imagine it is, but I mean, I, I, I, you know I don't have ■ but I know I've ■ and I was on it for awhile you know,

RS You know the effects of it.

■ I know I mean it makes you uh think weird shit and do things that you shouldn't do you know what I mean your train of thought is just like not normal you know.

RS What about um, do you know what he was ■?

■ Uh ■ I think. Yeah his mother would probably know she's got all ■ and all that. I mean I just, I just, you know in my opinion you know I know how he is when he was doing ■, he'd never come around.

UM Would you see if you can get these people preferably to leave?

RS Okay.

UM Since we've got an active shooter, he's already fired twice.

RS Okay.

UM And (inaudible) if they've got family, friends or somebody they can go to and a phone number so we can get them notified when the coast is clear.

RS Okay.

UM So.

█ These people?

UM Yeah, them and the other guy down there. So he's already shot twice I guess he hit two (2) cars.

RS Okay.

UM And he does have one (1) rifle so we don't want anybody else getting hurt.

RS Okay.

UM I'm going to take █.

RS Okay.

UM So if you can work on the.

RS I got one (1) more person to talk to then I'll go do what.

UM Thank you.

RS So uh

█ I think he's just, I think he knows he's, he's messed up, I think he knows that you know he should be taking his medicine and I think he's come to a

RS Mm hmm.

█ A (inaudible) here that you know he needs, he knows he needs to get help but he doesn't want to.

RS Right.

█ And uh apparently I guess he came up here I don't know I guess he got in a fight with his mom and them.

RS Yeah I don't, I don't really know all the details, so I'll talk with her.

█ Yeah you know like I said I went to the store then █ says well you ready for this, that's my other boy, what's that, █ up █ and got a gun on a cop or something, I said what!

RS Now who's █ whose house is he at?

█ That's █ right, that's her right there.

RS Okay.

█ █ apparently is over there at her house. I, I've never been over there.

RS Okay.

█ I don't know what the living situation is but, but I know █ use to live right down the hill.

RS Does he live there?

█ No, no he's got his own place, no electricity um up in her old house but, but █ use to live in this house right over here that my girlfriend lives in now, she lived with this guy just right there and I think that's when he got acquainted with █ and █ that was oh quite a few years back.

RS Okay.

█ Like probably in ninety seven (97) something like that.

RS I mean do, do you have any idea why he came up here today?

█ I don't know I guess to see █ and █ I don't know.

RS Okay.

■ I, I, like I say I haven't talked to ■

RS And from what I understand (inaudible). Obviously you don't agree with what he does.

■ No he doesn't come around when he's fucked up and he knows, cause I tell him you know. We got in a argument while back cause he needed, one of his water lines broke, (inaudible). And my other boy ■ was up his house after we had that cold weather remember?

RS Mm hmm.

■ And I said what are you doing and he said fixing ■ water, says well where's ■ at, he's in the house asleep, I said what, that don't (inaudible) right there you know.

RS Right.

■ So anyway a while after that ■ was over my house and uh came in said something about you know needed help fixing his water, I said well why can't you fix it ■ just needs a you know you need a pipe wrench or something or, only time you ever want to help dad is when you want me around is when you want me to help you, cause he'd babysat once in while,

RS Mm hmm.

■ When you know we'd go out or something, it's like we always pay him you know and he's sitting in a nice house, watching a big screen T.V. watching his little brothers you know that are you know nine (9) and eleven (11) now, I said you know what ■ fucking help yourself, you know what's wrong with you I says, you got two (2) good arms, you know you're an able bodied man, you know he got mad at me, you know cause I, I tell him how it is you know.

RS ■ has, has, has he been violent towards you or other people when he gets like this?

■ He never, never gets violent with me, he never has. Towards his mother and stuff I think so.

RS Yeah.

■ You know them but he doesn't, he doesn't go there with me.

RS Okay.

■ You know he just don't come around you know.

RS When he's doing something like this he stays away from you?

■ Yeah he don't come around me I mean cause he you know, just like my other boy was messed up for a while you know in to this north side, south side I says you know what ■ I says don't come around here, don't come around my house, don't come around my other kids, you want to be in that gang shit I said you go ahead, but you keep it away from us.

RS Right.

■ I says you know if that's the kind of life you want to live, I mean that's kind of you know how I am with kids you know it's like. In her words, I'm so black and white. (Inaudible).

RS (Inaudible) pretty, I see what your saying that's black and white there, stay away for it.

■ Yeah I mean I don't want no part of it you know.

RS Well ■ is there anything else I haven't asked you that would be important for me to know>

■ I don't know I mean.

RS I mean have you been seeing a decline, I mean you haven't been really around them much but have you been seeing a decline in his mental help at all?

■ I seen his, his, his ■ you know and, and, I've seen it and I've seen him messed up before and then I seen him when he got help and he's on his ■ and, ■ and he was big and healthy and, and uh he was pretty much a normal person,

RS Okay

■ You know lately I've seen his ■, his physical health deteriorate and, and I think that, that you know is the reason why he's doing what he's doing is because you know he's probably not (inaudible), he's probably not eating and ■.

RS No.

■ You know and stuff like I mean he needs you know he's not like a dangerous bank robbing, murdering criminal he's just you know he just, he needs help you know.

RS Right.

■ But I fear the worst right now you know.

RS Alright ■ we'll end the interview at eighteen fifty five (1855).

■ HI mean he's got a good heart I mean he's got a lot of good in him.

End of transcript.

Transcribed on 12/14/07 by [REDACTED] 0608.



HUMBOLDT COUNTY DISTRICT ATTORNEY'S OFFICE INVESTIGATION REPORT

DATE: July 16, 2007
CASE: HCSO #200703162

Witness: Officer Ron Harpham, Eureka Police Department-

DA Investigator: William Honsal

On June 7th, 2007 at 1515 hours, I interviewed Officer Harpham, Eureka Police department, regarding HCSO case # 200703162. Sgt. Bart Silvers (Arcata Police Department) assisted with the interview. The interview was recorded on cassette and the following is a summary of Harpham's statement. For a detailed statement refer to attached transcript of the interview.

Officer Harpham is currently employed as a Police Officer with the Eureka Police Department (EPD). He is also assigned to the Special Weapons and Tactics (SWAT) as a sniper/observer.

On June 3rd, 2007, Officer Harpham received a page notifying him of a SWAT callout. Sgt. Bill Nova, Eureka PD SWAT Commander, advised that the Sheriff's office requested mutual aid regarding a barricaded [REDACTED]. The [REDACTED] had fired a rifle at the Sheriff's officers when they attempted to do a welfare check. The Sheriff had deployed their tactical team and contained the [REDACTED] to the residence. The sheriff then called EPD SWAT to respond to the scene to assist in the operation. Sgt. Nova advised EPD SWAT, 3 members from patrol rifle team, and Negotiators to be ready to deploy from EPD at 0030 hours.

Officer Harpham responded to EPD and loaded the SWAT equipment into several vehicles. The SWAT team deployed at 0030 hours and arrived at the scene, Bloody Camp Road and Jasper Hostler between 0200-0300 hrs. Upon arrival Officer Harpham put on his gear and waited for the information briefing. Sgt. Nova then briefed all the officers regarding the [REDACTED] description and about the two shootings earlier in the night. Also Sgt. Nova gave the officers the rules of engagement. The officers were not to fire at the residence unless [REDACTED] was a threat to a life. The SWAT officers on scene were to react to such a threat with the reasonable use of force. [REDACTED] was armed with several rifles and handguns. The positions of the HCSO SWAT personnel were also displayed on the board.

Officer Harpham was deployed to the Northwest side near the Yurok Tribal police vehicle. Officer Harpham was teamed up with Officer Gary Cooper. Officer Harpham and Officer Cooper's job was to monitor the [REDACTED] movement on the West and North sides of the residence. The area they were initially deployed would be severely compromised during daylight. Harpham pulled back to an area that was approximately 118 yards away and he observed the two sides of the trailer from that distance.

At approximately 0445 hours, Harpham observed a [REDACTED] shadow on the Northside. He observed a male [REDACTED] standing inside the #2 side bedroom and he appeared to be changing his clothing. He then saw lights going on and off throughout the residence as if the [REDACTED] was walking around. At approximately 0545 hours all the lights turned off.

At sunrise, Officer Harpham used 10x binoculars to check the condition of the #1 and #2 sides of the residence. He observed the bathroom window was opaque and was shut. The front door was shut. No [REDACTED] movement was seen from 0545 until 0900. Harpham did not hear the [REDACTED] attempt to communicate with police. Harpham stated if the [REDACTED] attempted to talk to the officers during the night he would have been able to hear the [REDACTED]. Officer Harpham stated that the night was calm and it was "all quiet."

At 0900 hours, Harpham and Cooper were relieved by HCSO SWAT personnel. EPD SWAT then returned to the Command Post where they rested and waited for further orders.

At 1000 hours, HCSO attempted negotiations with the [REDACTED] without any response. At that time it was determined that GAS was going to be deployed into the residence. HCSO requested EPD SWAT to assist with the GAS deployment. Tim Jones and Luis Altic were going to assist HCSO with the GAS Deployment. Officer Harpham was called up to the #4 side to check the range from the police vehicles to the residence. Officer Harpham used his range finder and determined the vehicles were approximately 25 yards away. While HCSO and EPD were getting ready to deploy GAS Harpham heard Sgt. Fridley from HCSO attempt to negotiate [REDACTED] out of the residence. Negotiations were loud and on going. Harpham never saw or heard a response from [REDACTED].

Harpham observed the HCSO team deploy several volleys of GAS into the #4 side. After the introduction to GAS on the #4 side, the Command Post determined that GAS deployment was also needed on the #2 side.

Officer Harpham led the EPD SWAT team to the #2 side for GAS deployment. EPD SWAT was ordered to deploy 5 volleys of GAS into the #2 side window. The team moved to a position that was approximately 81 yards to the North of the #2 side. That was the closest position of cover on the #2 side. As GAS was being deployed, Officer Harpham took a position slightly away from the team, approximately 75 yards away from the #2 side. Officer Harpham's assignment was to provide lethal cover on the #2 side as the team was deploying gas. In between volleys, Officer Harpham could clearly hear HCSO Negotiators attempting to talk [REDACTED] into giving up.

After the volleys into the #2 and #4 sides, Officer Harpham heard "Thumping and Banging" sounds coming from inside the residence. According to Harpham, it sounded like [REDACTED] was trying to break through a wall or floor.

During the deployment of GAS on both the #4 and #2 sides, Officer Harpham could clearly hear the negotiator from HCSO over the PA system. Harpham stated that as soon as he saw white and black smoke rising over the #4 side, the HCSO negotiator told ██████ to get out of the residence because it was on fire.

Officer Harpham noticed the different smoke / fire come from the #4 side after the HCSO SWAT team deployed the 2nd hand canisters into the windows. According to Harpham, the fire took a really "long time" to spread from the #4 side to the #2 side. Harpham did not hear any voices coming from the residence. If ██████ attempted to communicate or give up, Harpham could have heard him. Harpham stated that in this area where the house was located was very quiet and he could hear birds from 100+ yards away. At anytime, ██████ could have yelled for help from inside the residence he could have heard the cries and responded appropriately. No such cry was ever heard.

Officer Harpham and his team held their positions the entire time in case ██████ surrendered or needed to be rescued from the residence. They gave up their positions when HCSO called in the fire engines to suppress the fire. When the fire trucks moved in the EPD SWAT team then stood down. Officer Harpham and his team then responded back to the command post where they were checked out by the investigation team.

Officer Harpham did not observe ██████ fire his weapon during the incident. He did not shoot his weapon observe any officers shoot their weapons during the entire incident. All rounds from his weapon were accounted for.

Disposition: Supplemental report referred to HCSO.

1
2
3
4
5
6
7 **INTERVIEW WITH (RON) HARPHAM**

8 Q=William Honsal

9 Q1=Man

10 A=(Ron) Harpham

11
12
13 Q: The date is June 7, 2007 at 1515 hours. We're interviewing (Ron) Harpham
14 upstairs, EPD. Ah, in the cushy chair room conference room. Ah, (Ron), can
15 you spell your last name for the record?

16
17 A: It's H-A-R-P as in Paul H-A-M Mary, as in Mary.

18
19 Q: Okay, we're going to discuss the ah, the incident that happened up just north
20 of north of Hoopa off of Bloody Camp Road. And this incident started on
21 June 3, 2007. Ah, can you ah, tell us how you were made aware of this call?

22
23 A: Yeah at ah, about 8:30, 2030 hours on Sunday the 4th, I received a page and a
24 phone call from ah, Sergeant (Nova) who told me that there was going to be -
25 that there's a operational call out. Ah, he gave me brief details that it had to
26 do with ah, ah, a [REDACTED] barricaded in a house up in a remote area of Hoopa.
27 And he had exchanged rounds on several occasions with a sheriff deputy.

28
29 Q: Okay. And um, so at that point were there any ah, deployment orders for you?

30
31 A: No. Yes, to be ready to go, operational and ready to go at um, 0030 hours on
32 the 5th.

33
34 Q: Ah, you mean on the 4th?

35
36 A: The 4th is Sunday.

37
38 Q: The 4th was yesterday, so Sunday was the 3rd?

39
40 A: I'm - okay, then I'm - yeah I'm (unintelligible). Today is the 5th, right?

41
42 Q: Yes.

- 44 A: Okay. It was on the 3rd when I originally got the page and call at 2030 hours
45 from (Nova), and then at 0030 hours on the 4th is when I was supposed to ah,
46 meet with EPD and be operational.
47
- 48 Q: Okay. At that point um, you responded to the station and you were
49 operational. Um, what happened at 0030 hours?
50
- 51 A: I mean I was here obviously a little before to get ready.
52
- 53 Q: Okay.
54
- 55 A: And ah, in my mind um, hearing this guy that was long gun - shooting with
56 long guns and ah, that it was a (roll) operation, ah, I was um, because I am the
57 senior sniper for the department, and ah, ah, my role was - with SWAT is as a
58 senior sniper and then I am a ah, entry support member. So I kind of had - I
59 wear basically two hats, but I have one primary hat. And ah, so I - I was
60 starting to process it, getting all my sniper really gear going, thinking that that
61 would be - this was going to be actually a real need for a (unintelligible). And
62 ah, and (Nova) said, ah, told me to get in our operational greens, which is OD
63 green versus my ah, digital camouflage. And ah, he says all we're going to be
64 doing is taking over internal security or ah, yeah, internal perimeter work.
65 And ah, so I said, okay. Um, you know, I just - that didn't seem, you know, so
66 I took most of my - I took my long rifle - so I took two rifles. I took the AR15
67 which is a scoped precision rifle, and ah, I also took my sniper rifle and took
68 some of my gear associated with that with my sniper duties. But I dressed
69 basically as I would if I was to assist SWAT entry in some entry situation.
70
- 71 Q: Okay.
72
- 73 A: With a duty belt and gas mask, et cetera.
74
- 75 Q: Okay. So um, when you respond to the station and you got your stuff ready to
76 go, was there any kind of a briefing at the station before you left?
77
- 78 A: Yes. That would have happened at about 0030 hours.
79
- 80 Q: Okay. At 0030 hours, was there um, ah, you said - you said that ah, that you
81 were - that (Nova) assigned everyone as basically you were to take over the
82 internal perimeter from the sheriff's deputies that were out there at the scene.
83
- 84 A: Right. Around - at approximately between 2:00 and 3:00 in the morning.
5
- 86 Q: At that point were you given ah, the [REDACTED] description?
87
- 88 A: Yes.

134 A: Regarding that?

135
136 Q: Regarding the [REDACTED] or the team's mission at that point?

137
138 A: Not at that point.

139
140 Q: Okay, so then you guys all loaded up and then drove up to...

141
142 A: Yeah, I was assigned - what they did was for each of the operators, and we
143 have four of them, two team leaders because we're kind of short, a - the ah,
144 support members ah, were assigned to each operator. So then that was ah, ah,
145 that was the initial plan. I was assigned to (Todd Wilcox). Once we got up
146 there, ah, I don't know the reason why, I was assigned to Cooper. Cooper is
147 not a ah, and I didn't ask. Cooper is not entry with our - with our department
148 at this time, ah, and ah, although he is in the SWAT school and was entry for
149 the sheriff's department. And um, I don't know whether they were thinking
150 that because of the environment it didn't matter. They - I, you know, I'm a
151 qualified sniper so ah, I don't really know why the decision was made.

152
153 Q: Okay, so initially your team was broken up. Um, and it was - you guys were
154 teamed up with another person.

155
156 A: Right.

157
158 Q: And then you were spotted out there. You got there. Um, what happened
159 when you initially got to the scene off Bloody Camp Road near the residence
160 where the [REDACTED] was held up?

161
162 A: Ah, we geared up and we had a briefing at that point. Um, and we were - still
163 we were told ah, we received a little bit more detail that there were two
164 primary incidents where the [REDACTED] had fired rounds. The first time I think
165 the SO Officer (Taylor) had fired rounds back. And in the second incident,
166 three of the sheriff's department SET team members returned fire. And ah,
167 those incidents all occurred here is my belief at this point right here.

168
169 Q: Okay. So um, were there - at that briefing were there rules of engagement that
170 were given to you guys?

171
172 A: Yeah, yes.

173
174 Q: What were those rules of engagement?

175
176 A: Rules of engagement were ah, that, you know, if we saw him ah, walking
177 around the house wandering in a nonthreatening manner, even if he was
178 carrying a weapon around or whatever, ah, you know, we were not - not to

179 shoot. Ah, only if - if ah, the weapon barrel basically was coming out the
180 window and it appeared he was shooting, aiming, pointing, shooting at
181 someone was use of force. If he exited the building, because one of the
182 weapons that was ah, that he was ah, listed - they listed the series of weapons
183 that he had and the series of weapons that were in the gun cabinet that could
184 have been there, which included AR15, an AK47, ah, a .22 scoped rifle, a
185 shotgun, and there was a handgun.

186
187 Q: Okay, so what is - what do those guns mean to you? What significance are
188 those?

189
190 A: What those guns mean to me is that ah, he has the capability of placing a very
191 lethal weapon accurately in my direction at long ranges. A hundred yards for
192 some of those weapons might be considered a short range.

193
194 Q: Mm-hmm.

195
196 A: So um, ah, so it meant be very, very, very careful.

197
198 Q: Got you.

199
200 A: Don't expose yourself, don't let him know where you're at to your best ability.

201
202 Q: The rules of engagement were given to you.

203
204 A: There was more.

205
206 Q: Okay, go ahead.

207
208 A: Because he had a pistol. And so I wanted to clarify on - about him breaking
209 the perimeter. And ah, and I asked, so he comes out unarmed, I mean this
210 question was asked. He comes out unarmed, and ah, he attempts to escape the
211 perimeter, and if ah, it was um, it was advised that he is not by any means,
212 which was deadly force, he was not to be allowed - we're not going to get in a
213 foot chase with him. He was not leaving the premises. So if he exited the
214 house and he complied with commands, that's all good. But if he exited the
215 house and he tried to go foot bail, deadly force was authorized.

216
217 Q: Got you. Um, so at that point did you receive orders of deployment?

218
219 A: Yes.

220
221 Q: Okay. What were those orders?
222

223 A: The orders were ah, Cooper and I were to have basically the toughest
224 situation. Um, we were - (Randy Garcia), the sheriff's deputy, was to lead us
225 to that location. And the reason why it was tough was because it was ah, ah,
226 an exposed situation for the rifle and ah, and then that was the reason why it
227 was tough. It was an exposed situation for the rifle.

228
229 Q: Okay.

230
231 A: And at daytime we were going to have to retrograde to better position.

232
233 Q: Okay. So you were put in - you were basically put in a position where you
234 were provided cover from the [REDACTED] initially?

235
236 A: It - we - we had some cover, some ah, basically the cover of the vehicle.

237
238 Q: Okay.

239
240 A: Of this vehicle right here.

241
242 Q: Can you go ahead and mark that as a number one as far as your first
243 deployment area?

244
245 A: Yeah. And this is ah, this is on the west side of the house.

246
247 Q: Yes.

248
249 A: And ah, and so that vehicle is um, was our only real cover and/or
250 concealment. And ah, ah, but it's considered a very - once we got there ah,
251 and we spoke to the deputies who were manning it, I don't recall who they
252 were, ah, they had - it was very important because it covered um, the window
253 which was ah, a window to the bathroom.

254
255 Q: Okay.

256
257 A: Right here. It also - this - this is out or proportion.

258
259 Q: Mm-hmm.

260
261 A: But it also had a good line of sight of a back bedroom window on the number
262 two wall. And it also had the front door.

263
264 Q: Okay.

265

266 A: So it was crucial that we kept eyes on that location, ah, even though number
267 two actually I learned later was actually was covered I believe by a sniper
268 team and by EPD and other support units.
269

270 Q: Okay.
271

272 A: But on this and the door. Um, so and it's about - it's approximately - the truck
273 was approximately 40 to 50 yards back. I did not lay the range find that
274 position.
275

276 Q: Okay.
277

278 A: So what happened - I carried out both rifles. Um, I had my other rifle in a
279 drag bag and I had all - I had all the kit I needed to pretty much to do the hide
280 - build a hide and do something along those lines (unintelligible). So ah,
281 Cooper stayed at the car with the night vision goggles. And I went back up,
282 breached the fence and went up here trying to find a place while it was still
283 dark that I could build a hide where we could both sit and ah, or lay and
284 continue observation in the daytime and get away from this vehicle. We were
285 concerned that if we started up at this vehicle and at that point it could cause
286 an agitation where he's firing and ah, we would then be in a poor situation to
287 fight back. And it just would - it could have created a bad situation. So, but
288 upon searching all up in here, the minute - and of course this - this would
289 really be more appropriate if it was - if it was right about here.
290

291 Q: Okay. Feel free to draw it in there.
292

293 A: And so - that would be a good idea.
294

295 Q: Okay, go ahead and X out the other number one. Okay.
296

297 A: So ah, um, and so what the problem was was - and this was the problem. The
298 problem was right here, which is right about right here, there is a tree. Okay,
299 with some branches that went out like this. So once I got about here, all of a
300 sudden the tree starts blocking ah, this window and this door.
301

302 Q: Okay.
303

304 A: So I needed to keep ah, and um, it only got worse the more that I went up. So
305 I needed to keep it somewhere right in here that I found the hide, and we were
306 willing to go back, you know, 100, 150 yards. We didn't want to go that -
307 really we didn't want to go that - that far back. We wanted to go about 100
308 yards. Because the reason why is if he broke containment and started running
309 we needed to contain him. So ah, but the problem was, this was just nothing

310 but berry bushes and thickets. And there was just no place that we could put -
311 put a hide where we could see through it.

312
313 Q: Mm-hmm.

314
315 A: Some of it was thickets 20, 30 feet thick. And so I - it wasn't like if you had a
316 brush pile, I got pruners, I could cut through a trail and peek a hide out
317 through there. I couldn't do it. So ah, after probably an hors worth of
318 searching up in there, I gave up that idea. First with Cooper, but then, you
319 know, he - Cooper said, you know, Cooper reminded me and said, we can't be
320 here at daylight, and now we're down about maybe 45 minutes away from it.
321 So what I did was I went down to the end of the road where it turned.

322
323 Q: Mm-hmm.

324
325 A: And I saw that I had a clear shot, ah, clear observations and shot to the front
326 door, um, here and we also could see ah, see this here at least for exit.
327 Couldn't see into it at all.

328
329 Q: Okay.

330
331 A: So what the plan was was I actually came down here and I built a hide down
332 here right along the edge of the road and then I built - there was grass along
333 here. I built like a little - I was out a little bit in the road and built a grass hide
334 here. And then ah, we backed it up, started it up and - well let me explain this.
335 During that - most of that time there was a light on, visible. There was
336 flickering lights because there was windows - there was windows here, like
337 this. There was windows here. You see flickering lights from the TV here.
338 This light came on at one point and stayed on. And the bathroom light was
339 on. So up until around a quarter to 5:00 we saw - we would see occasionally
340 activity, lights come on, lights go off, things like that. And then about a
341 quarter to 5:00 he came here, and we watched him for about 10 minutes. He
342 was doing the oddest thing, and we have no idea what he was doing. Very
343 weird body movement. We see this shadow. And ah, we think it was that he
344 was changing clothes, because he's going to go to bed. Next thing you know,
345 about quarter to 5:00, this light goes out, then this light goes out, and then the
346 TV goes off.

347
348 Q: Quarter to 5:00.

349
350 A: And then we never heard hide nor hair of him until we started gassing him.
351 So ah, anyway, getting back, so we backed up and ah, I - Cooper sat in the
352 passenger seat as cover with the door open and I backed it up. And when I got
353 right - right here to this location, I cranked it this way and buried a corner into
354 the ah, that's kind of - actually kind of off on the angle. But I buried it into the

355 corner there so Cooper could cover over the engine block and I stayed here in
356 a lower position behind a hide on my rifle. It was 118 yards to the front of - to
357 the front door.

358
359 Q: Okay. So where were you when you started seeing the movement at 5:45?

360
361 A: Here.

362
363 Q: Okay. That point there. And um, you saw the figure in the number two side in
364 that room there. Did you actually see a person or you just saw a shadow?

365
366 A: We just saw the shadow.

367
368 Q: Okay, just saw the shadow and just some weird kind of movements. And then
369 you said about - how long was he in that room that you could see that
370 shadow?

371
372 A: Boy, I'd say off and on he came back and was doing ah, causing shadows onto
373 that window for about five to ten minutes.

374
375 Q: Okay. And then about 5:45, that's when you saw that room - lights shut off?

376
377 A: Yeah.

378
379 Q: And then the room...

380
381 A: The bathroom.

382
383 Q: The bathroom shut off.

384
385 A: The bathroom is here and then...

386
387 Q: The light in the living room, kitchen area?

388
389 A: The TV, it wasn't lights. You could see the TV flickering. I mean that's what
390 we figured it was.

391
392 Q: Okay. And that came off. Besides those, the things you just described here,
393 was there anything else that led you to believe that there was someone inside
394 that during the night?

395
396 A: While I was there?

397
398 Q: While you were there. If there was things that you heard, if there is things that
399 you had observed.

400

401 A: No.

402

403 Q: Any signs of life?

404

405 A: No.

406

407 Q: Okay. So ah, just before daybreak, you then took a position 118 yards to the
408 west. Ah, northwest.

409

410 A: One thing. I did see, you know, earlier from the time we were there I saw
411 lights come - I saw the light come on. So I saw this room was dark. I saw the
412 lights come on and I saw both these two lights be turned on. And then it was
413 maybe another hour before we saw all this activity back here.

414

415 Q: Okay.

416

417 A: So (unintelligible). Sorry.

418

419 Q: No, that's good. Any sounds that you heard?

420

421 A: Not - not up to that point.

422

423 Q: Okay. You moved - moved your position. Okay? Um, what did you observe
424 from that point?

425

426 A: Nothing. No signs of life. Well, except for there was a - towards the end of
427 our deployment there, which I think - I don't know for sure. I don't remember
428 (John) saying anything to us. It was probably around - it might have been
429 around 8 o'clock. All of a sudden the dogs - a couple dogs showed up. And
430 there was one time when we thought we heard someone talking to the dogs.
431 Btu we didn't know whether it was because the dogs - because the dog was on
432 the other side, which would have been over here. I don't know. And it was
433 barking. I don't know whether it was sheriff's deputies talking or...

434

435 Q: Now you said dogs showed up. Where did you see the dogs or understand the
436 dogs were.

437

438 A: They came out here. One of them actually walked all the way out and came to
439 about here, sniffed us and decided we were good and came back. It was kind
440 of like a light colored pit bull. And the other one was a dark mutt is the best
441 way to describe it. It was a mangy short 40 pound dog, long - longer black
442 hair.

443

444 Q: Dark, black. Yeah. There are a lot in Humboldt County.

445

446 A: Yeah. Especially up there.

447

448 Q: Yeah, okay. Um, so then the dogs - you heard what sounded like someone
449 conversing with the dogs once the dog started barking.

450

451 A: Yeah.

452

453 Q: But you couldn't identify where that might be coming from.

454

455 A: No, and the dog was clearly on this side of the house.

456

457 Q: On the outside.

458

459 A: Barking. And so we didn't know whether he was - the dogs like had just
460 showed up. Did he let them out? Where did he let them out at, because we
461 didn't see the door open.

462

463 Q: Right.

464

465 A: Or did they just wander in some place else? And the dogs looked like - the
466 white dog pit bull looked like he had just woken up because of the way he
467 stretched and actually yawned I think, so.

468

469 Q: Okay. Okay, so now it's day break. You see the dogs. Um, anything else you
470 observe? One question.

471

472 A: Yeah.

473

474 Q: When you're looking through your optics at the 118 yards.

475

476 A: Yeah. Both binoculars, 10 power binoculars and 14 power scope. And
477 actually the scope was primarily powered down to 4 power, because I wanted
478 to keep both windows and the door all in my view.

479

480 Q: Okay.

481

482 A: I got all three of them just barely in my view if I kept it powered. So I
483 powered down most of the time, unless there was something I wanted to look
484 at.

485

486 Q: To the best of your knowledge um, on the number one side starting with the
487 bathroom window, was that window open or shut?

488

489 A: Ah, the bathroom window was shut.

490

491 Q: Um, could you see through that window.

492

493 A: No, we could not.

494

495 Q: Was it frosted or was it covered?

496

497 A: I believe it was some kind of - it was some kind of frosting.

498

499 Q: Okay. Was the door on the number one side, was that open or shut?

500

501 A: The door was shut.

502

503 Q: Were there any windows next to the door at all or?

504

505 A: I could barely see these two windows here.

506

507 Q: And were those open or shut on that side?

508

509 A: I - I could barely see. I can't...

510

511 Q: And the window on number two that you could kind of see, ah, was that an
512 open window?

513

514 A: There was a point of time in the very beginning when I thought it was open
515 like three inches. Ah, but then at some point he might have closed it because I
516 - I thought I'd made an observation and then the next I know I was going well,
517 I thought that thing was open. You know, I had one of those kind of lapses.
518 And the rest of the time it was clearly closed.

519

520 Q: Okay. Ah, so when you're making these observations through your binocs or
521 your four power scope on your rifle.

522

523 A: Right.

524

525 Q: Okay. At some point did anything change or do you observe anything from
526 your position where you made your hide?

527

528 A: No. As a matter of fact we figured that he'd gone to sleep.

529

530 Q: Okay.

531

532 A: Because it just was dead after that.

533

534 Q: Okay. All quiet.

535

536 A: All quiet.

537

538 Q: At one point were you relieved from your position?

539

540 A: Yes.

541

542 Q: Okay. What time was that?

543

544 A: I want to say it was ah, close to 9:00, give or take a half hour.

545

546 Q: And ah, what were your orders at that point?

547

548 A: It was to ah, to go back to the command center.

549

550 Q: Were you relieved by anyone?

551

552 A: Yeah. We were relieved by sheriff's deputies. I do not recall which ones
553 there were.

554 Q: Okay.

555

556 A: (Unintelligible) those guys.

557

558 Q: Right. And you returned to the command post.

559

560
561 A: Returned to the command post, told that we were going to be standing down
562 for two hours. So strip out of your gear, kick back, relax, get a coffee or
563 water, donut, whatever. And um, at ah, sometime a little bit later, maybe after
564 being there an hour, (Nova) said that the plan was to start introducing - was to
565 send the correctional - the CDC negotiation team forward and have them try
566 to establish communications. And ah, if that failed they were going to
567 introduce gas, at which time we would be used again, but that we had about
568 another hour.

569

570 Q: Okay, approximately an hour passed and you guys got called into action
571 again?

572

573 A: Yeah.

574

575 Q: Okay. What were your - what was your mission at that point?

576

577 A: At that point it was decided that ah, ah, that we were going to um, go up as a
578 team and go forward to this position right here where the marked vehicles
579 were at. Actually we were going to stop short of it. Our two gas ah, officers,

580 which were going to be (Tim Jones) and (Louis Altic), at some point were
581 going to move forward when the sheriff's department ran out of gas. And
582 when they moved forward to deploy the gas, I do not know - I think they were
583 going to deploy it from the front of vehicle number one. We were going to ah,
584 move the team up and provide lethal cover to protect them while they did that.
585 Um, so while we were sitting back here - and then we got told to stand down
586 because there was a decision made to get a CDC, I think it was a CDC
587 helicopter in a close location at a helo base in case we had an injury.
588

589 Q: Okay.

590
591 A: Ah, I went forward and ah, did a laser range find, found this distance for
592 everybody, because most of the operators had (unintelligible) techs sighted in
593 for 25 yards.
594

595 Q: Mm-hmm.

596
597 A: And we've done the training so that we know what the drop is, but they
598 needed to know the distance so that they could refer to their training for the
600 drop on the rifle, and the gas guys also ah, needed to know, because ah, as a
601 general rule they usually don't shoot that gas past 50. So they're going to have
602 to be a little creative or experienced wise if they were shooting past that. And
603 I found basically from the front of the vehicle to the front of the house was 65
604 yards. I used my range finder. And from the back of this vehicle here
605 shooting to the center of the wall here was 75 yards.

606 Q: Okay. So that information was given to the team, the SO team that moves
607 forward?
608

609 A: Yeah,.

610
611 Q: Okay.
612

613 A: Yeah. During that waiting time it was ah, Sergeant ah...

614
615 Q: (Quenell)?
616

617 A: No, ah...

618
619 Q: (Garcia)?
620

621 A: No, Sergeant ah, (Fridley).
622

623 Q: Oh, (Fridley).
624

625 A: Sergeant (Fridley) was doing verbal ah, ah, attempts to negotiate with the guy.

626

627 Q: So commands started?

628

629 A: Yeah. And () or () come on, contact us.

630

631 Q: And how were those commands given?

632

633 A: Over a PA system from this point right here.

634

635 Q: From a - a handheld PA?

636

637 A: That I don't know. (Unintelligible).

638

639 Q: But there was a PA system that was - what was you - let's change tapes now,
640 I'm sorry. It is 1545. We're resuming the interview with (Ron) Harpham.

641 Okay, so um...

642

643 A: (Fridley), Sergeant (Fridley).

644

645 Q: Sergeant (Fridley) was...

646

647 A: On the PA saying - trying to talk to the house, trying to talk to the house. I
648 think he was using the name () instead of versus (). It was things, if I
649 remember correctly, () come on out. Ah, we need to talk. We need to
650 get this over with, see if we can help you. You know, () just come out
651 the front door. Ah, leave your weapons behind. We just want to help you, see
652 how we can solve this problem, kind of limited to terms like that.

653

654 Q: Mm-hmm.

655

656 A: So it was - I mean it all sounded appropriate as far as I was concerned.

657

658 Q: And was - would you classify that as being loud, soft? How was that PA?

659

660 A: It was loud enough to have been heard.

661

662 Q: In the house.

663

664 A: Yeah. Because the windows were broken out here and here.

665

666 Q: Okay.

667

668 A: And it was a small house.

669

670 Q: Got you. Okay. So, at that point you were called up to support the SO that
671 was off [REDACTED] Road there. Ah, did your mission change at all at that point?
672
673 A: Yes, it did.
674
675 Q: Okay.
676
677 A: The ah, the SO began introducing gas. And basically until they ran out of gas.
678
679 Q: So they were deploying gas to the number four side?
680
681 A: Yes.
682
683 Q: And then where were you when they were doing that?
684
685 A: Back here.
686
687 Q: Okay. Can you mark that with number two?
688
689 A: Yeah, maybe 30 yards, 40 yards back.
690
691 Q: Okay. So at that point, ah, your mission changed you said?
692
693 A: Yeah.
694
695 Q: Okay. What were you - what was your mission at that point?
696
697 A: Well one of the things that happened was that ah, one of the things that
698 happened was that the two sniper elements from the sheriff department were
699 running out of battery, and one of them had lost their comms with the
700 department or with the ah, command staff. So ah, we sent (Rico Sanchez) up
701 to join one of them. And he would have been about right here. So (Sanchez)
702 was 83.
703
704 Q: Okay.
705
706 A: And the sniper was here. So they were about right here and they were
707 covering ah, number three.
708
709 Q: So they're on the east side.
710
711 A: On the east side.
712
713 Q: And they're covering number three?
714

715 A: Right.
716
717 Q1: (Unintelligible).
718
719 Q: No problem. We'll stop the tape just for a second.
720
721 A: And later - a little bit later, shortly after that, I learned that - no actually before
722 I went up there, because - because of how our next mission was going to be, I
723 asked (Quenell), Sergeant (Quenell) whether um, there was a sniper unit, Sierra
724 unit covering two, because we were going to be heading to this location. And
725 he advised me that there were, so I know - so I advised (Wilcox) who was
726 going to be in charge of our little patrol that we need to be concerned and
727 coordinate with this other Sierra unit to be sure that we weren't in line of sight.
728
729 Q: Right.
730
731 A: So ah, we ended up going as a team minus (Rico Sanchez). And ah, we left
732 the ah, command area going up towards the road up here, the one up to the top
733 of the hill. And what our command - what our orders were was the wind was
blowing from ah, north - north to south.
735
736 Q: Okay.
737
738 A: The wind was blowing this way.
739
740 Q: Okay.
741
742 A: So the gas that they're introducing on this side of the building, it really wasn't
743 getting back here, or that may have been their belief. I'm not sure. I'm
744 assuming that's what they would get.
745
746 Q: Right.
747
748 A: But the wind was blowing this way and the gas was coming back this way at
749 the - towards the - in fact they had to gas - they had to mask up.
750
751 Q: Got you.
752
753 A: So they wanted gas delivered on this side of the building. So that's what they
754 asked our team to do. So we patrolled out this way up a hill. By this time
755 Cooper and I already knew the area, because we came back this way. So ah,
756 Cooper and I basically led it up here, until we got up here. And then ah, we
757 stopped up here. I suggested to (Todd) because although I had - there was a
758 telephone pole right about here, and I had marked it, indexed it, so that I could
759 help at least orientate, you know, with that. And so I had a good idea where

760 the house was, but, you know, it's like you're - you've got this patrol of six
761 people.

762
763 Q: Right.

764
765 A: And you really don't - you reach a point where you don't really know where
766 you're going. You don't want to take them in and have to back them out or
767 whatever, so I said - I asked them - I told them, I just suggested to the team
768 leader, send - and I was too heavily equipped. I had a packs. I was carrying
769 extra ah, rounds for the gas gun, et cetera. And ah, ah, I said send Cooper up
770 to scout and find where we want to be and bring the team up to him. And then
771 it was decided that (Wilcox) and Cooper would go as scouts. They did. They
772 went out and found a location ah, about 81 yards. And I know that because I
773 gave - again it was very important for the ah, gas guys to know the range. So
774 they found a position that was ah, north of two that was 81 yards away. That
775 was quite a bit longer than what I think (Jones) has ever fired gas. I think his
776 longest was about 50.

777
778 Q: Right.

779
780 A: So ah, I think he's got some interesting stories to tell about that. But anyway,
781 um, so that's where - so he set ah, (Wilcox) set two gas guys right here,
782 (Jones) and Cooper - and Sergeant (Johnson). Actually the whole team was
783 right here. And he asked me to go over here and try to find a place for lethal
784 would cover of this here. So I came over here and crawled into a hide,
785 probably - actually it was probably even with them. Pretty much even with
786 them. It might have been 75 yards away. So I was here Sierra three. So I was
787 - I was right here. And that - Sierra three in location three.

788
789 Q: Okay.

790
791 A: So ah, um...

792
793 Q: So your mission at that point was what?

794
795 A: Lethal cover on that window, and observation, what actually ended up being
796 the most primal - or the most important role. And so then they shot gas.

797
798 Q: Okay.

799
800 A: Okay? And they had their command, which I think was to get five good
entries.

801
802
803 Q: Okay.

804

805 A: It took ten rounds to get five good hits. Get five of them in there, pause, and
806 then fire five more. And ah, I couldn't see him. I don't know who - which one
807 shot which round. I could see the rounds impacting, breaking the glass,
808 hitting the wall, bouncing off the wall, going through the wall, et cetera. Um,
809 and ah, so during that process there was also times when there - there was a
810 few times when the sheriff's department came in and brought gas in. They
811 came in and they had um, a ballistic ah, curtain.
812

813 Q: Mm-hmm.
814

815 A: And ah, they were carrying that, and they came in as a team and they would
816 drop and they would run out of the missile - gas missile. So they dropped - I
817 know they dropped it in, I believe two times. But then they were at the point
818 where they asked for gas delivery on the number three side into this window
819 right here. So ah, I know (Jones), I don't know whether um, (Altic) went also.
820 But they then - a couple of our officers moved over here and they came to this
821 position here. I do not know the range, and they fired gas at this window here.
822 And I - from where I was at I could see those impact on it. And ah...
823

824 Q: So your position didn't change.
825

826 A: So my position didn't change. No, I stayed in the same position. Really, to be
827 in my position would actually have been right about here, because I can
828 actually see this window here too. And I can see through the broken glass
829 here. I could see deep into the back of the window with my binoculars.
830

831 Q: Okay.
832

833 A: Or if I powered up my scope to a higher power.
834

835 Q: So you could see into the room?
836

837 A: Yeah.
838

839 Q: Okay.
840

841 A: So during that time I - I marked things that I could see, things in the back
842 along the floor, the chair, and close to the window, a piece of metal hanging.
843 There was a series of things that I tried to mark, memorize their position in
844 case he came in and moved them and I didn't see. Because the way that it was
845 going, the gas - all the gas - everything vented out to the south side.

846 Q: Mm-hmm.
847
848

849 A: So whatever we went in there didn't stay there that long. But during the
850 process of gassing him, once I was over here, there was a couple times I
851 would hear thumping and banging along the wall. It seemed like it was over
852 here some place. But in this end of the building, maybe over here. But I
853 could definitely here someone thumping in there. Ah, at some point, you
854 know...

855

856 Q: What were you thinking as far as how or what that something was from?
857 What is your - what is your opinion on that?

858

859 A: My opinion in it was I - I had two thoughts. One, right here there was a shed,
860 lean to shed that attached there.

861

862 Q: Okay.

863

864 A: And I thought, you know, what if he's trying to kick a hole into the shed and
865 try to get into the shed. That was one thought.

866

867 Q: Mm-hmm.

868

869 A: And the other thought was just that he was like, you know, he was fighting the
870 pain of the tear gas and in that process, you know, he was ah, trying to build
871 up his courage by screaming and yelling and punching and kicking things, you
872 know, kicking walls, you know what I mean?

873

874 Q: Yes.

875

876 A: Getting his anger up and his adrenaline up so he can continue to fight it.

877

878 Q: Um, now you heard thumps. Did you hear any screaming? Did you hear
879 yelling? Did you hear anything like that?

880

881 A: Never heard anything like that.

882

883 Q: Nothing . Just thumping. Got you.

884

885 A: Okay.

886

887 Q1: Could you have heard it from where you were do you believe?

888

889 A: Yeah. I could. Because with the window - this window was breached by our
890 gas.

891

892 Q: Okay. And you're still at that point, gas being delivered, um, it's daylight.
893 Um, did you - did you hear any more PA announcements?

894
895 A: Yes, they continued throughout, especially once it was ah, noted that there
896 was a fire in there.
897
898 Q: Okay.
899
900 A: The fire happened - it started after the second time the sheriff's department
901 went forward.
902
903 Q: Okay.
904
905 A: Went forward to drop something in. Somewhere around that point.
906
907 Q: Okay.
908
909 A: From my observation.
910
911 Q: From your observation.
912
913 A: It may have been before then, um, but there was almost always a constant
914 flow of ah, white smoke coming out. Um...
915
916 Q: When they deployed gas or after what you think was a...
917
918 A: You know there was - there was pretty much a continual process of - as I
919 remember it seemed like there was always some white smoke venting
920 somewhere out - out this way. Sometimes more than others, like right after
921 the sheriff's department made a drop or we started (unintelligible).
922
923 Q: And you think that's from chemical agents?
924
925 A: Yeah.
926
927 Q: You're saying it's a white - white smoke? Kind of...
928
929 A: I did not know or think that there was a fire, because I lost comm for a while,
930 and I did not um, know that there was a fire until I heard um, (Fridley) over
931 here starting to change his mantra, and it was, (██████) we believe the house is
932 on fire. You need to come on out. Come out and leave your weapons, you
933 know, and that whole process. But he repeated over and over and over on the
934 loud speaker and I could hear it up here. (██████) we believe your house is on
935 fire. So then I started looking at the smoke going, is that gas or is that smoke.
936 And it - and at the first I couldn't tell, but then you could start to tell.
937
938 Q: And how could you tell?

939

940 A: Because the gas was pure white, almost like steam. And the other was dirtier.

941

942 Q: Dirtier meaning just?

943

944 A: Dirtier smoke.

945

946 Q: Smoke. Um, so ah, when the fire occurred on the number four side, you were
947 still looking at the number two side.

948

949 A: Yes.

950

951 Q: The window was broken. You could see inside. You took note of the items
952 inside. What was the condition of that room? Was it smoky. Was it open?

953

954 A: I don't know.

955

956 Q: Was it clear?

957

A: I don't know. It was the very last um, room to become filled with smoke.
959 And as a matter of fact, ah, I could see um, because - and it was very
960 important to me because I knew that this was his only place out. And if he
961 holds to the very last, this is the point he's either going to, you know, come out
962 fighting, surrendering or running, one of the three or whatever.

963

964 Q: At any point did you hear any noises coming from there that was consistent
965 with someone yelling for help?

966

967 A: No, not at all.

968

969 Q: Screaming? If someone was yelling for help or screaming or saying I give up,
970 would you have heard them?

971

972 A: Yeah. But then what started happening as the fire - I started seeing smoke
973 coming out of the vents up right above this room.

974

975 Q: Mm-hmm.

976

977 A: So it was in the roof long before I saw smoke in to the - back into this room.
978 And ah, but what started happening, I started hearing the bumps again. But
979 this time I couldn't tell whether it was the building popping, the roof popping
980 and cracking and things like that. So never - never heard a human voice come
981 out of there, a cry for help or anything like that. It was a very quiet
982 atmosphere up there way up in the mountains, the woods. Birds were - I mean

983 I was - I was - to stay aware I was focusing on listening to birds. They were
984 everywhere.

985
986 Q: Okay. You bring up a good point. Do you spend time out in the woods?

987
988 A: Yes.

989
990 Q: Okay. And could you hear birds from long distances away?

991
992 A: Yes.

993
994 Q: Okay. And so hearing birds from distances of 50 yards, 100 yards? What
995 would you think?

996
997 A: I would say 150 yards. And the reason why I say that, I specifically
998 remember hearing the ravens.

999
1000 Q: Okay.

1001
1002 A: And ah, they have that - that clicking sound.

1003
1004 Q: Mm-hmm.

1005
1006 A: And um, or that it's a clucking or clicking sound. And I was here, and then I
1007 looked up where I thought I heard it, and way over here north of the building,
1008 south of the building, I saw two ravens flying - flying my way.

1009
1010 Q: So you're confident to say if someone was inside that room, inside that house
1011 yelling at the top of their lungs for help, I surrender, I give up, you being 81
1012 yards to the north of number two could have heard them?

1013
1014 A: Yes. And Ill tell you another reason why I would have - I would have heard
1015 that. It's because of the unique sound of the human voice. This comes from
1016 my Marine Corp training is that, you know, we were trained like on - because
1017 I was Vietnam era so we trained a lot in small unit patrols and night time
1018 patrols, things like that. And when - what we - what we learned from this
1019 experience was that ah, you know, you had to use hand and arm signals, or to
1020 get someone's attention at night, or else you had to get right to their ear and
1021 whisper, to get someone's attention you used clicking or clucking sounds like
1022 ((clicking sounds)). Those kind of noises are natural in the woods, in the
1023 woods or in the - out in the field. So they don't carry. And human - as a
human you don't pick them up subconsciously.

1024
1025
1026 Q: Mm-hmm.

983

984

985

986

987

988

989

990

991

992

993

994

995

996

997

998

999

1000

1001

1002

1003

1004

1005

1006

1007

1008

1009

1010

1011

1012

1013

1014

1015

1016

1017

1018

1019

1020

1021

1022

1023

1024

1025

1026

1027

1028 A: And so we tested - I mean we tested this and I've learned it many times out
1029 there from hunting and from just the kind of work I'm doing here, and ah, is
1030 that ah, you'll be out in the woods alone walking, and I mean I know you guys
1031 have experience. And then you hear this ((coughing)) and you freeze. That's
1032 not natural. It sticks way out. It's the same thing. And then if ah, you're
1033 walking down the street and, you know, there is other noise mixed in and then
1034 you hear a terrifying scream or something like that, it - your subconscious
1035 picks it up. It comes right to the very center of your being.

1036
1037 Q: Mm-hmm.

1038
1039 A: You see what I'm saying?

1040
1041 Q: Right.

1042
1043 A: So even if there was a lot of outside noises you pick up - that would have been
1044 - the human voice would have been so out of the ordinary and you know, you
1045 would hear that, it would filter through. I mean I have this experience. It
1046 filters through all to the collage of natural noises that are around.

1047
1048 Q: Right.

1049
1050 A: And your - and the human subconscious picks it up. There was - the whole
1051 time I was here, I never heard him yell, scream, talk, say anything that I could
1052 discern came from him. Certainly not what you're saying.

1053
1054 Q: Right, okay. And then...

1055
1056 A: As a matter of fact I was concerned that - I was joking about it with Cooper
1057 that - I said to Cooper. I said, you know, Coop, I think he escaped while we
1058 were over here, and he would have escaped on our watch, because we were
1059 the last ones to see him in there because he turned off the light.

1060
1061 Q: Right.

1062
1063 A: So if he's not in there, I told him, it's on us. Because the only way out would
1064 have been through us.

1065
1066 Q: Right.

1067
1068 A: And so I was kind of joking with him about that. That's how...

1069
1070 Q: Yeah.

1071

1072 A: Convinced I was. That's how - because I - we hadn't heard anything since 5 -
1073 or 4:45 ah, that I was - I was convinced that he was ah, or I was not convinced
1074 that he was even in there.

1075
1076 Q: So um...

1077
1078 A: And we never heard a gun shot.

1079
1080 Q: Okay.

1081
1082 A: Until the fire got heavy, about - I mean it was this - it was already pouring out
1083 this window in here.

1084
1085 Q: Okay.

1086
1087 A: And I just figured that was ah, I mean I it was heavy here, it was hot and
1088 smoky here. And it sounded like it came from in here. And it sounded - it
1089 didn't sound like a gun shot, it sounded like a round of like firecrackers going
1090 off. So I thought it was just rounds cooking off.

1091
1092 Q: Right. Um, would you classify this fire as a rapid burning fire through this,
1093 slow, normal?

1094
1095 A: No.

1096
1097 Q: How would you classify the spread of this fire?

1098
1099 A: I don't know how to classify it, but I know that um, I was talking to ah,
1100 Cooper and said I want to find the manufacturer of that home, because that
1101 thing took a long time to burn. And I didn't, you know, talk, you know,
1102 (unintelligible) but it seemed like it took a long time to take off and to ah, to
1103 become one to where - towards the end it was heating it up fast, but it seemed
1104 like it just took a long time from the point I realized that there was a fire up
1105 there for it to really get going, because I was anxious. Now something has got
1106 to happen.

1107
1108 Q: Right.

1109
1110 A: You know, it's one thing to withstand the gas. I've seen that happen before.
1111 There are a lot of ways to do that, but you can't - it's not going to deal with
1112 this.

1113
1114 Q: That's right.

1115

1116 A: So something is going to happen .And it's like, it just seemed like get going,
1117 get going, and it wouldn't go. And so we made it - and it was a joke that well,
1118 because well I think the tribe build mobiles homes, so someone said that -
1119 they said the name of the company or whatever.
1120
1121 Q: Hoopa Manufacturing.
1122
1123 A: Yeah, Hoopa Manufacturing or something like that.
1124
1125 Q: Yeah.
1126
1127 A: But yeah we were - we were - I was - I was actually making the joke that I
1128 want to find out that manufacturer's name because that thing...
1129
1130 Q: (Unintelligible).
1131
1132 A: So that was my opinion is that it really took a...
1133
1134 Q: It took slow.
1135
1136 A: Yeah.
1137
1138 Q: So in your opinion, if someone was inside there and wanted to flee the fire,
1139 they had opportunity to do so?
1140
1141 A: Yes.
1142
1143 Q: If they were notified of that?
1144
1145 A: Yes.
1146
1147 Q: And getting back to your position...
1148
1149 A: We saw - and I don't remember any gas being fired once it was recognized
1150 that um, that the fire had started. All gas was stopped from my recollection.
1151
1152 Q: Okay. Did you feel safe once the fire started on the number four side to
1153 approach the number two side?
1154
1155 A: No.
1156
1157 Q: Okay. Why was that?
1158
1159 A: Well, because I thought that the - that that fire was the beginning of the ending
1160 of this incident. Um, it really - I mean I felt he was going to either blow his

1161 brains out or he was coming out. What - he had lasted this far. It was, you
1162 know, the [REDACTED] experience, right?
1163
1164 Q: Mm-hmm.
1165
1166 A: Okay, so what if he sits in there to have done all the other things he's done,
1167 and then he sits in there and he's able to fight off repeated gas. Now you've
1168 been in the gas chamber, you've been - you've been through the gas
1169 environment. Do you think you could have done what he did? I know I
1170 couldn't have done what he did. And um, for him to go through that, this man
1171 is serious about not being taken into custody. So I was anxious.
1172
1173 Q: So you felt that this was the time where action was going to take - take place.
1174
1175 A: This is (unintelligible). Yes.
1176
1177 Q: How long did you stay on the number two side?
1178
1179 A: All the way - all the way until they called the fire truck up.
1180
1181 Q: Okay.
1182
1183 A: And of course I saw the - this side never really did - it was like a tornado of
1184 smoke in here. That was the last place right there.
1185
1186 Q: So in your opinion, um, you're a police officer not a firefighter, but being the
1187 fact that you've had a lot of life experience, in your opinion do you think at
1188 that point in the number two side through that window, could someone still be
1189 alive with the amount of smoke that you saw in that room?
1190
1191 A: Negative.
1192
1193 Q: Okay.
1194
1195 A: It looked just like a tornado on a teepee.
1196
1197 Q: Okay. And no flame but just a lot of smoke.
1198
1199 A: Right.
1200
1201 Q: Okay. And um, so at that point you abandoned your side, um, and then did
1202 you totally demob at that point? Did you wait? What did you do at that
1203 point? What were your orders?
1204
1205 A: Really I didn't receive any orders.

1206

1207 Q: Okay.

1208

1209 A: I just started packing up my kit and moved up to the top of the hill where
1210 others from that ah, covering two and three were starting to mobilize,
1211 probably somewhere here between ah, this position and this position. And
1212 then they just headed on down. Back down to the ah, command center.

1213

1214 Q: Okay. Ah, at your position was there a shot ever placed by either your - your
1215 - your rifle, now I mean rifle, your sniper gun, your Remington 700, your
1216 AR15 or your side arm?

1217

1218 A: Nope. All the rounds I took are accounted for.

1219

1220 Q: Okay. And um, at that point you went back to the command post and you
1221 were checked out by um, your team leaders and then the ah, the - the District
1222 Attorney's Office?

1223

1224 A: Yes.

1225

1226 Q: Okay.

1227

1228 A: Actually, I was not checked out by a team leader. Um, just by the District
1229 Attorney (unintelligible).

1230

1231 Q: All right. Good deal. Anything else? (Mark)?

1232

1233 Q1: (Unintelligible).

1234

1235 Q: And did you have a serial number for me?

1236

1237 A: Yeah. And I have ah, ah, four rounds - (unintelligible) rounds in the - in the
1238 rifle.

1239

1240 Q: Okay.

1241

1242 A: (Unintelligible) rifle and I had ten rounds in one of my pockets. Um, it's a
1243 Winchester Model 7308. The serial number is G as in [REDACTED] -- [REDACTED]

1244

1245

1246 Q: (Unintelligible). So you had four rounds in the gun and then ten rounds in a
1247 pocket?

1248

1249 A: Yes.

1250

1251 Q: Okay. Sounds good. Anything else that you want to add based on the
1252 diagram, based on anything there at the scene that you want to add that will
1253 help us out in this?
1254

1255 A: I can't think of anything.
1256

1257 Q: Okay. Concluding the interview at 1610 hours.
1258

1259
1260 This transcript has been reviewed with the audio recording submitted and it is an accurate
1261 transcription.
1262

Signed

A handwritten signature in black ink, appearing to be 'RH', is written over a horizontal line that spans the width of the page.

DATE: _____ TIME: _____

11 316

KSO # 200703162

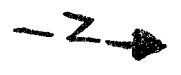

K20

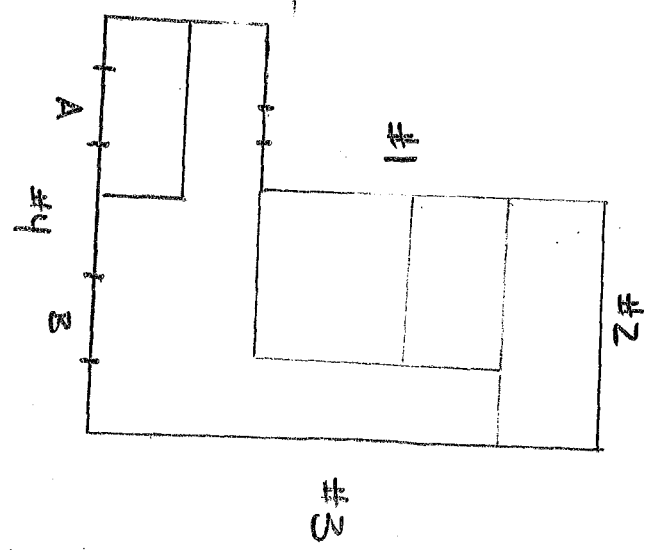

HVTD HVTD

Jasper House RD

1/4 MILE →

Bloody Camp RD

INVESTIGATOR _____

WITNESS: _____

HUMBOLDT COUNTY SHERIFF'S DEPARTMENT

CASE: 200703162
INTERVIEWER: Sergeant Wayne Hanson
SUBJECT: Attempt P.C. 187/ Officer Involved shooting.
STATEMENT OF: Sergeant Mike Fridley, #1
DATE & TIME: June 5th, 2007 @ 1325 hours.
LOCATION: Hoopa Substation, Hoopa, California

ALSO PRESENT:

WH Wayne Hanson
MF Mike Fridley

WH This is Sergeant Wayne Hanson, it's um June the fifth (5th), two thousand seven (2007), approximately uh thirteen twenty five hours, I'm at the Hoopa Substation with Sergeant Mike Fridley uh discussing uh an incident that occurred in Hoopa on Sunday uh and this is case two thousand seven three one six two (20073162). This incident occurred at [REDACTED] residence uh in Hoopa. Mike it came to my attention today through um D.A. Investigator Mike Hislop that um you had some tape recording um that you took on Sunday regarding this incident at [REDACTED] residence, shots fired?

MF Yes.

WH And uh you currently a um hostage negotiator for the Humboldt County Sheriff's Office?

MF Yes I am.

WH Okay, I'll let you go ahead and narrate regarding uh you're on scene at [REDACTED] residence uh on duty in full Sheriff's Department uniform?

MF Yes.

WH In a marked Sheriff's Department truck, excuse me, uh vehicle, patrol vehicle?

MF No I was hiding behind a Hoopa Tribal Police Vehicle, it's marked, Expedition.

WH Okay, it has a light bar on top?

MF No they, I don't believe they have light bars.

WH Okay and you're arrived at um scene because what type of a call?

MF Um that they had a stand off situation and I was requested to respond to negotiate.

WH Okay and Detective um Steve Quenell already spoke to you on late Sunday night or early Monday morning?

MF Yes.

WH Took a statement from you?

MF Yes, yes sir.

WH Okay. Um okay while you're on scene, you have a um cassette recorder with you?

MF Yes.

WH Okay and why don't you just go ahead and just tell me uh what happen, what time uh it was that this was all transpiring?

MF Okay uh it's pretty standard for the Sheriff's Department, I don't know that there's a policy but we record our negotiations so that's why I had the tape recorder going is the incident, as we would negotiate with the [REDACTED] we'd turn the tape on, I'd try to notate the time, negotiator uh tape what I was saying to him and at the end of that I would turn the tape off, try to, if I could remember say the time when I stopped, so the tape kind of bounces around and there's a lot of dead space in it but that's pretty much the procedure is just for uh later on we can tape record the, the negotiations and to critique it and maybe possibly for litigation later down the road. Um at this point where this incident was happening there was two (2) Hoopa Tribal units parked below the residence, um there was one (1) closer to the residence and one (1) further back, um I was using the second (2nd) vehicle back, Jason Daniels and I, Deputy Jason Daniels, he was acting as my couch, I was the primary negotiator, we were on the drivers side of the vehicle, using the engine block as cover and kneeling down um and the S.E. T. Team members were up using the front vehicle as cover um at some point near twenty fifty three (2053) hours, I remember somebody yelling that he was opening one (1) of the windows, so when I heard that I turned the tape back on, I wanted to start negotiating with him again cause I knew that he was at a window and he could hear me and we were using the Public Address System.

WH Is that on the patrol vehicle?

MF On, on the patrol vehicle, on the second (2nd) patrol vehicle.

WH And about how far from your patrol vehicle to the house were you in feet?

MF I,

WH Ball park.

MF It's probably about fifty (50) yards I don't know how many feet it was.

WH Okay.

MF Uh when the window, I didn't see the window open cause I was obviously in my position behind the, the vehicle, I turned the tape on um and I, I tried to contact him, and as soon as I started to talk to him, I heard, I didn't really hear the shot, I heard the bullet come near very close to where I was sitting at and go into the brush on the side of the road,

WH (Inaudible).

Mf Just, just past me, it would be on the, the south side of the road, I heard it go through the brush it made like kind of a whizzing sound as it went past me.

WH And the patrol vehicle that you're trying to obtain cover behind, you're south of the residence, would be your, your position?

MF Yeah it would be south, south east.

WH And that sound that you heard um you used the word "whizzing" have you heard that before,

MF Yes.

WH Uh around?

MF Yes.

WH In your training?

MF Yes and I mean it was, I, you could hear the shot and the whizzing almost in one (1) one (1) constant sound, it was like fluid.

WH And you captured that sound on a tape recorder?

MF Yes, yes as soon as I heard that I yelled "shoots fired".

WH And then what happened after you heard shots fired?

MF Within a second or two (2) I heard the, the what I, the S.E.T. Team that was in front of me returned fire.

WH Okay and Detective Quenell already spoke to you about that?

MF Yeah.

WH Okay and then a point in time you, you, you took um numerous tapes of your negotiations?

MF Yes there's uh six (6) tapes total, I secured those from the vehicle when the, at the conclusion of the incident, I brought them back to the, the Hoopa Station and uh when I was here I thought maybe that I had captured part of the shooting on the tapes, so I played back the tapes until I got to the tape marked "tape number one (1)" and it's on side B uh you can hear basically what I just described to you, it's captured on the tape.

WH Okay and then you booked those into evidence at the Hoopa Sub?

MF Yes.

WH And then uh today's date and time on June the fifth (5th) two thousand seven (2007) you're going to give those tapes to me and I'm going to transport them to our evidence locker at Main Station in Eureka and place them into evidence. Um okay and there's several hours worth of recordings on these tapes?

MF Yes there are ninety (90) minute tapes so, I think all of them but the last one (1) are completely full.

WH Okay um that's about all I have, anything else you think we need to add in this?

MF Uh that if I was asked to estimate how close, I heard that bullet go through the brush near us that it was within five (5) feet of where I was at.

WH Okay and you're by uh,

MF By the sound of the bullet going through the bushes, I heard it going into the bushes and

WH Okay.

MF I would estimate that it was within five (5) feet of where I was at.

WH And how long can you estimate while you're on scene that the time, once you arrived till the shoots fired at you, was it five (5) minutes, twenty (20) minutes, an hour, two (2)?

MF Oh we'd been there several hours.

WH before the shot was fired and the negotiations several hours with uh the [REDACTED]

MF Yes.

WH Who is the [REDACTED] that you believe (inaudible).

MF [REDACTED] [REDACTED]

WH Okay. That's about all I have. Ending tape at thirteen thirty two (1332) hours.

End of transcript.

Transcribed on 7/19/2007 by [REDACTED] 0608.

HUMBOLDT COUNTY SHERIFF'S DEPARTMENT

CASE: 200703162
INTERVIEWER: Sergeant Wayne Hanson
SUBJECT: Attempt P.C. 187/ Officer Involved shooting.
STATEMENT OF: Sergeant Mike Fridley, #2.
DATE & TIME: June 5th, 2007 @ 1445 pm.
LOCATION: Hoopa Substation, Hoopa California

ALSO PRESENT:

WH Wayne Hanson
MF Mike Fridley

WH This is Sergeant Wayne Hanson date is um June the fifth (5th) two thousand seven (2007) it's fourteen forty five (1445) hours, I'm at Hoopa Substation with Sergeant Mike Fridley discussing case two thousand seven thirty one sixty two (20073162) this is the second (2nd) interview with um Sergeant Fridley today um regarding what happened at um [REDACTED] residence um continuation from Sunday and Monday on June the fourth (4th), actually June the third (3rd) June the fourth (4th) a continuation, Mike um after Sunday's event um where (inaudible) the tapes where "shot's fired" are gonna be heard on your tape, you go home at uh a certain time on Monday morning to

MF Yes.

WH To get some rest and then you respond back to the incident on Monday.

MF Monday morning yes.

WH On June the fourth (4th), what time was that?

MF I came to work at eight (8) and I drove pretty much straight up there from (inaudible).

WH Okay and um your duty again on that date was the negotiator for Humboldt County Sheriff's Office?

MF Yes.

WH Okay and you're on scene for about how long uh your on scene on Monday and then you're witnessing our uh special enforcement team deploying chemical agents, is that correct?

MF Yes.

WH Do you remember what time that all started?

MF I do not know. What had happened was those, the special enforcement team were using protective masks, chemical masks, um and they weren't able to talk into the radio's so I was acting as the, the calm person, letting the command post know what was going on so I watched them insert the gas and up, updated the command posts as to what was going on with them.

WH Oh so you were relaying?

MF Relaying. So I had eyes on them the whole situation when they, (inaudible) gassing.

WH And you're positioned again about how far from the structure where [REDACTED] [REDACTED]

MF Still back at the second (2nd) vehicle like uh where I was negotiating from, if I guessed it was somewhere around fifty (50) yards.

WH Okay and while you're there um you're on scene for how long, hours before a Special Enforcement Team is deploying chemical agent?

MF I think it was probably a couple of hours, I didn't really look at my watch.

WH And during those couple of hours before uh chemical agents are deployed um you're on the loud speaker uh advising the [REDACTED] inside to please come out, surrender?

MF Yes.

WH Do you know how many times you uh?

MF I couldn't tell you, um I tried to do it at least every ten (10) or fifteen (15) minutes, sometimes it would go longer, I would talk for three (3) or four (4) or five (5) minutes and then stop and just pick it back up you know another fifteen (15) twenty (20) minutes after that.

WH And Lieutenant Cavinta was uh contacting the radio and also requesting you other times to,

MF Yes.

WH Do that also wasn't he. Okay you're on scene for several hours um negotiating over a loud speaker requesting the guy to please surrender and at a certain point um Lieutenant Cavinta authorized the use of chemical agents as a tool to make the [REDACTED] come out?

MF Yes.

WH Okay and just tell me what you witnessed when chemical agents were being deployed.

MF They were uh two (2) different types of chemical agents, there was, I guess they're called ferret rounds that you shot from a little short shotgun looking thing. I saw them shot those toward the windows and try to hit threw the windows on side four (4).

WH Which is the south side?

MF Yeah and they had them had them mark as window four "A" (4 A) and four "B" (4 B) they were trying to shoot, shoot threw those, they also shoot uh some shotgun rounds, I don't know what those are called, gas rounds?

WH Yeah. It, it would be a twelve (12) gauge and then uh are you familiar with a thirty seven (37) millimeter?

MF Yeah.

WH Did you see both of those?

MF Yes.

WH Being deployed. Can you tell which um S.E.T. members were deploying them?

MF I saw Deputy Brian Taylor and I believe it was Deputy Jamie Barney.

WH Okay. And um this transpires for quite a while?

MF Yes. It was in conjunction with volleys of gas that were being introduced from the other side of the house as well, I'm not sure, I never got to see that so I don't know which what, what windows or side of the house they were actually shooting at but I could hear the radio traffic they were trying to coordinate the two (2) volley's together, they would, I mean one (1) would go and there would be a time and then the other one (1) would go.

WH Okay during this time frame do you hear um any voices or see any movement, or hear any movement from inside the, the structure?

MF I did not.

WH Is there a point in time that um, um a couple deputies approach the house with a um ballistic blanket?

MF Yes.

WH Okay why don't you tell me what you saw there?

MF That's the point where I was doing the relay that I was telling you about uh several of the S.E.T. Team members when up to the house on the south side, they, they were calling it side four (4).

WH Can you tell which members those were?

MF Uh I couldn't tell you exactly, I saw Sergeant Quenell, Deputy Brian Taylor, Deputy Jesse Taylor, Deputy Blake Massaro and Deputy Barney, those are the one's (1's) that I seem to remember going up there. I don't know who did the introduced the, the gas cause I couldn't tell from the distance.

WH And all these deputies are positioned behind a large uh ballistic blanket for protection?

MF Yes.

WH And what kind of gas did they introduce this time?

MF It was a hand held canister, I don't, I'm not a chemical admissions person,

WH Okay.

MF It's just like a grenade top, you pull the pin throw it and um I saw them throw at least one (1) canister into the first window and then they move to window "B" which is on the corner, it would be the south east corner and they, I saw at least one (1) canister placed in that window, as soon as those went off, I saw white smoke come from outside the house, or come out the windows.

WH Did they have to break the windows to put these things in or do you recall?

MF I believe there were holes in there already from the ferret rounds and the shotgun rounds, they were able to just throw them through the open windows.

WH Yeah we're talking about side four (4) windows "A" and window "B"?

MF Yes.

WH And can you recall a total of how many canisters were put in each window?

MF I think there was two (2) in each one (1). They placed two (2) canisters, I saw at least one (1) I'm thinking it was two (2) in each one (1) but I'm not one hundred (100 %) percent sure.

WH Okay. And you said you're not sure which deputy um put them in the windows. After the last canisters put in the window you're seeing volumes of white smoke or what are you seeing?

MF Yes white smoke coming from both window "A" and "B" um and then the S.E.T. Team retreated and the whole time I was updating the command post you know what was happening, smoke was introduced, the team was half way back um and then they made it back to the front of the tribal rig, that uh was closest to the, the house.

WH And then uh what happens next, is the period of time you see a different color smoke?

MF Uh eventually the white smoke stopped and there was no smoke at all, and from the point that there was no smoke at all till I'm guessing cause I didn't look at my watch was probably five (5) to ten (10) minutes, more closer to five (5) I started to see uh black colored smoke coming from window "B" which is on the, it would be on the three (3) four (4) corner,

WH Okay.

MF Um and it started to get thicker and thicker and then smoke started to come out of window "A".

WH Okay

MF And it,

WH You mean a large volume?

MF It turned white, it turned black, it was a large volume then it would, like almost slow down and then it would puff out and then for a long time it was just smoke coming out of the house, um I got on the P.A. numerous times and, and told Mr. [REDACTED] or I tried to tell Mr. [REDACTED] that we thought the house was on fire and they needed to get out and um, eventually we could see flames, or I could see flames coming out of window "B", and again I got on the P.A. many, many times and told them the house was on fire and you needed to get out and um and the fire just kind of progressed, just kept getting worse and worse and worse, I could hear what sounded like um rounds going off, popping in the fire.

WH Okay and you weren't sure if that was heat induced or somebody shooting?

MF Yeah I don't know if they were shot or yeah burning up?

WH But multiple um rounds going off?

MF Yeah.

WH From the time of the black smoke until you see flames um and uh the structure looks like it's fully engulfed, do you have a time estimate?

MF For fully engulfed?

WH Yeah ballpark?

MF Uh I probably thirty (30) to forty five (45) minutes, like I said I wasn't looking at my watch but I remember it was take took a long time that but it just smoked for a long time.

WH Okay and again you never heard any voice from anybody inside and no doors open up, nobody attempted to come out?

MF No. At one (1) point when the it was still just black smoke we heard, or I heard some kind of a pop or a bang come from window "B" area, I don't know if it was a gun shot or something popping in the fire, or what but it was a, a popping sound.

WH Okay. And then um uh a point in time, were you there when the fire department uh approaches the structure to put it out?

MF Yes.

WH And um our S.E.T. Team was with the, were they with the uh fire department for protection when they approached the structure?

MF Um I believe it was the Pelican Bay S.E.T. Team escorted the, the fire trucks up.

WH For their safety?

MF Yeah.

WH Okay um because we still don't know the uh where the [REDACTED] is at. Okay anything else you need to add about?

MF Well we could only see the fire on our side of the house, I don't know what it did to the other side.

WH Cause of your position on the south side?

MF Yes.

WH And with you that day is, anybody else with you as an negotiator?

MF No I was by myself.

WH Okay and that's all I can think of.

MF Okay.

WH Ending tape at um thirty fifty five (1355) hours.

End of transcript.

Transcribed on 7/24/07 by [REDACTED] 0608.

HUMBOLDT COUNTY SHERIFF'S DEPARTMENT

CASE: 200703162
INTERVIEWER: Sergeant Wayne Hanson
SUBJECT: Attempt P.C. 187/ Officer Involved shooting.
STATEMENT OF: [REDACTED]
DATE & TIME: June 11th, 2007 @ 10:15 A.M.
LOCATION: 793B Moon Lane, Hoopa, California.
ALSO PRESENT: Marvin Kirkpatrick, Detective

WH Wayne Hanson
MK Marvin Kirkpatrick
[REDACTED]
UM Unknown Male

WH Lets see it's six eleven two thousand seven (6 11 2007) at about ten fifteen (10:15 AM) in the morning, I'm hear at [REDACTED] house, what's your address here [REDACTED]

[REDACTED] Um I guess off Highway Ninety Six (96) they call it I guess.

WH Uh well what street is this?

[REDACTED] Moon, they call it uh Moon Lane.

WH Moon, this is Moon Lane?

[REDACTED] Yeah.

WH Is this your numbers here, [REDACTED]?)

[REDACTED] Yeah, it could be yeah.

WH Um [REDACTED] um what's your uh middle name?

[REDACTED] Uh [REDACTED]

WH [REDACTED]

[REDACTED] It feels like I'm being interrogated for something?

WH No you're not being, I'm just taking, and its [REDACTED] is your last?

[REDACTED] Yeah, if you're recording me, that's interrogation isn't it?

WH No I don't take any notes, I'm just writing some stuff here real quick. What's your date of birth?

[REDACTED] Um do I have to do this?

WH Well you didn't do anything wrong [REDACTED] I just wanted to ask you what, how [REDACTED] was on Sunday uh a week or so ago when you saw him?

[REDACTED] He was um, he, he, I don't know he, he, he had obviously something on his mind, he, he, he I could tell, I could tell he [REDACTED], um he was acting bizarre and I told him to leave.

WH What, what time on Sunday did, did you talk to him?

[REDACTED] Um about twelve (12), twelve (12) o'clock.

WH About twelve (12) o'clock?

[REDACTED] Yeah.

WH Do you remember what he was wearing that day?

[REDACTED] Uh he was wearing uh, yeah he was wearing uh a trench coat.

WH What color?

[REDACTED] I don't know, dark brown.

WH Dark brown?

[REDACTED] Yeah he, he was wearing a trench coat and um and I told him that he had to leave cause I had my kids around me.

WH How did he get here, who brought him here?

[REDACTED] He walked.

WH He walked. And by bizarre what, I mean was he saying anything off the wall to you, what was he saying?

■ Um yeah he, he was kind of, well see I had my kids around me and I didn't want my kids like hearing any kind of words he was saying so I told him to leave, flat leave.

WH I mean, well what I mean is was he saying off the wall stuff or what was he saying?

■ Yeah he was just being loud kind of,

WH Uh huh.

■ And I told him well um I, I said ■ well uh you can come back pretty soon,

WH Uh huh.

■ But right now is not a good time I told him and um and he just left.

WH Okay. Um how do you know he was ■ ■

■ I, I can tell I just, I've known him all my life so ■

WH Uh huh.

■ And ■, I, I can tell ■.

WH Oh by his um ■ or his?

■ Yeah by his words, just by, I mean just by talking to him.

WH Was he acting angry or?

■ No he wasn't acting any at all.

WH Was he being violent or?

■ No he was just saying just like a lot of little words, a lot of slang's.

WH Okay. When's the last time, on that Sunday you saw him, when was the last time you saw him prior to that?

■ That was it.

WH Well I mean you saw him Sunday like a week and a half ago or

■ No, no.

WH You.

■ No I seen him that day and then that was like the last day I seen him and then I heard about that up Bald Hill and then that was the last time I seen him I guess.

WH Okay and you asked him to leave because he, he just don't want him in front of your children?

■ Yeah, yeah, yeah just cause he, he, he, he just like saying a lot of little words I don't know.

WH Like cuss words or?

■ No he was just being loud like you know Hey! You know like, like, like, like yeah lets go do that or, or just like you know.

WH Okay, he didn't have a wet suit on or anything like that did he, was he carrying anything, back pack or anything?

■ No, no he just had a trench coat on on a hot day and that was it.

WH Okay. ■ uh what, what is your date of birth?

■ [REDACTED]

WH You have a phone number here?

■ Um yeah.

WH Could I get that from you?

■ Uh, uh [REDACTED]

WH [REDACTED].

■ Yeah.

WH Okay. And [REDACTED] Okay my names Hanson, um Sheriff's Office and this is um Kirkpatrick Sheriff's Office,

UM How you doing.

MK Hi how are you doing.

WH Thank you. Yeah I mean you're not in trouble, we're just trying to figure out what,

UM Yeah what.

WH I mean what, what led up to the problem,

UM Yeah (inaudible).

WH We had up there with him.

UM I don't know I heard it was um, [REDACTED] the, the person whose house they were and [REDACTED]

WH Right.

UM Uh, uh I, I heard it was they um, they burned him on some pills and they uh and some cash, and he got so pissed and then he just went up there and said I want my fucking money or my pills and uh and, and they didn't give it to him so then he fucking held, held it for um, (inaudible),

WH Who, who told you that [REDACTED] did?

UM What's up [REDACTED]. No just, just by hearing,

WH Oh the, the rumor, the rumor mill. Was he drinking that morning?

UM No. No.

WH Or did you smell any alcohol on him?

UM No. Hey [REDACTED] you got any uh, uh any uh any smokes. Hold, hold it a second you guys.

WH Sure.

[REDACTED] That's about what I heard too.

WH Pardon me?

[REDACTED] That's about what I heard too, I didn't like the what I heard.

WH What did you hear?

UM What he said.

WH Oh okay. What's your name sir?

UM I, I, you don't need to know my name but I just.

WH Pardon me?

UM You don't need to know my name but,

WH Okay.

UM Yeah but I just (inaudible).

WH The rumor in the valley.

UM I just feel sorry for them.

WH Well it's tragic.

UM Well these guys took advantage of him too because he had, he was you know kind of lose in the head or whatever but (inaudible).

WH Oh it, I mean it's tragic. Nobody wanted that outcome.

UM Yeah.

WH It's just tragic.

UM (Inaudible) but I can see the guilt in the people that lived there.

WH Yeah. Hey, hey [REDACTED] anything else you want to add or is that it.

[REDACTED] That's it. I, I all I know is that to me like he wasn't a bad guy I mean, I mean he didn't deserve the way he went. The way he went and died, he didn't, he didn't deserve that he wasn't no criminal, he was no like bad person that's why.

WH I mean what, what's going on here we're just trying to talk to everybody that say him that day to try to get a sense of why.

[REDACTED] Well to me.

WH What happened, why it led up to what it led up to.

■ I really don't know I mean his mom, his mom better, his mom could have been on his butt like stressing him out too I don't know.

WH Yeah.

UM He wouldn't move and (inaudible).

■ Yeah.

UM He moved from there and moved away.

■ Yeah that was weird how he passed on I mean he's my, I, I (inaudible) I've known him all my life.

WH Yeah. Yeah we're just trying to, trying to figure it out why it led up to what it led up to. Okay.

■ Me too.

WH Yeah.

MK Did you give him a ride up the hill?

■ No I didn't give him a ride.

WH He just walked off from here?

■ Yeah he, I told him he had to leave, he just walked off.

WH Was he here like ten (10) minutes, twenty (20) minutes?

■ Yeah he was just here for a short time.

WH And just walked up to your house?

■ Walked up to my house and said "hey what's going on" and I seen he had a trench coat on in a hot day, you know it was kind of warm that day.

WH How hot was it that day do you think?

■ At least eighty (80), not even eighty (80).

WH Okay.

■ Yeah it was a warm day.

WH And.

■ And had a trench coat on and had to be some kind of,

WH Does he normally come to your house to visit?

■ No not with a trench coat on.

WH Okay.

■ Not with a trench coat on you know what I mean?

WH Yeah.

■ I'm sure.

WH Okay.

■ Hey you guys get out of the car now you you're going to break it.

End of transcript.

Transcribed on 7/24/07 by ■ 0608.

1
2
3
4
5
6
7 **INTERVIEW WITH BRIAN QUENELL**

8 Q=Det. Schlesiger

9 Q1=Investigator Dunn

10 A=Sgt. Brian Quenell

11 A1= [REDACTED]

12
13
14 Q: Okay the date is June 20, 2007. The time is 1035 hours. Case 200703162.
15 We're at Sergeant Brian Quenell's residence in (unintelligible) 0872?

16
17 A: Mm-hm.

18
19 Q: Good memory huh?

20
21 A: Yeah you're good.

22
23 Q: Uh, (unintelligible) Detective Schlesiger and Investigator Dunn. Um, Brian
24 we talked a little bit on - was it Friday? Last Friday?

25
26 A: Yeah.

27
28 Q: About, um, and I told you that the CDC had come back and said that in their
29 inventory off that vest there was never a stinger ball or a stinger grenade -
30 whatever they call it - um, on that vest. And, um, what we're doin' now is,
31 uh, just clarifying, uh, what's - what the transaction was just of that with all
32 you guys that were down there with the vest and all that. Um, and before you
33 were resented- represented by [REDACTED] - is that correct?

34
35 A1: That is correct.

36
37 Q: And, um, have you spoke to him?

38
39 A: Yes I have.

40
41 Q: And you have no reason for him to be present during this?

42
43 A: No I don't.
44

- 45 Q: Okay. Um, going back to – it would have been the 4th of June then. Um, go-
46 how did, uh, a little bit more detail of how the discussion went on about what
47 was going to be used in the house.
48
- 49 A: Uh, Lieutenant (Unintelligible) was back at the command post and told me via
50 the radio that, uh, he wanted us to start introducing the, uh, flameless CS
51 canisters to the residence and that, uh, CDC would be bringing down to me,
52 uh, those items. He also authorized myself to introduce, uh, the - they're
53 called speed heat canisters as well if while we were introducing, uh, the
54 chemical agents that, uh, if the [REDACTED] starting firing upon us or made any
55 aggressive acts towards us that we could introduce those as well. CDC got a,
56 uh, tactical nylon vest down to my location which was at that front vehicle
57 and, uh, showed me what they had on the vest which included the, uh, tri-
58 chamber flameless grenades, uh, speed heat grenade and their team leader –
59 who I don't know his name – pulled a stinger grenade off the vest. Told me
60 that, uh, it had 32 caliber rubber pellets in it, uh, it was rated for indoor use,
61 and that upon deployment of it, it would explode sending the rubber pellets
62 into the room, uh, and also had a, uh, a chemical agent in it as well. I don't
63 recall if it was CS or OC.
64
- 65 Q: And the team leader – do you remember what he looked like at all?
66
- 67 A: He was a shorter guy, probably 5'7", 5'8", um, olive complexion with a dark
68 mustache.
69
- 70 Q: And he – was he dressed in full SWAT gear?
71
- 72 A: Yes he was.
73
- 74 Q: Okay. Did you ever see his name or anything like that?
75
- 76 A: I did not.
77
- 78 Q: Okay. So he brings this vest down to you and this stinger ball he mentions
79 how – how does that become into your possession?
80
- 81 A: Uh, originally we had placed their vest on Deputy (Barney), um, and he was
82 gonna deploy the munitions from the vest. I told him that, uh, I would prefer
83 to have him take those items off the vest that we were gonna deploy so there
84 was no, uh, chance of us accidentally sending in a canister that wasn't rated
85 for indoor use. So Deputy (Barney) took the vest off, uh, we removed the tri-
86 chamber, uh, flameless, uh, CS grenades from the vest and placed them on
87 Deputy (Barney)'s person. And then, uh, we also removed the stinger from
88 the vest and placed that on his person.
89

90 Q1: And this is before the first deployment?
91
92 A: No. This is the second deployment.
93
94 Q1: Okay. The first deployment was your guy's for SO's deployment of flameless
95 grenades right?
96
97 A: Yes.
98
99 Q1: (Unintelligible).
100
101 A: Yeah.
102
103 Q1: The aerosol or whatever it is.
104
105 A: The explosion grenades yep.
106
107 Q: Um, so when you guys went up to the residence that I believe it was the A
108 window or whatever, um, who deployed the stinger ball into the A window?
109
110 A: The stinger ball was deployed through the B window.
111
112 Q: The B window. Okay it was A then B right?
113
114 A: Correct.
115
116 Q: And who deployed that?
117
118 A: Deputy (Barney).
119
120 Q: Okay.
121
122 Q1: When it went in there did you hear anything after that?
123
124 A: Yes I did.
125
126 Q1: What'd you hear?
127
128 A: I heard it explode and what sounded like rubber pellets thumping all over the
129 room.
130
131 Q: Have you ever seen a stinger ball deployed before?
132
133 A: Yes I have.
134

135 Q: And was that -- did that seem consistent with what it was?
136
137 A: Yes it did.
138
139 Q: Okay.
140
141 Q: When you were down there Brian, um, when you were handed over the -- the
142 -- stinger ball, uh, did you look at it or anything like that?
143
144 A: I did not personally. Uh, only Deputy (Barney) did.
145
146 Q: Okay. And, uh, do you recall what it looked like at all?
147
148 A: Uh, it was, uh, brown rubber grenade looking munition. I mean we have 'em
149 in our inventory. I've seen 'em before.
150
151 Q: And are they, uh, do you know what color the writing is on them or anything
152 like that?
153
154 A: I believe it's got a white band around the middle of it with black writing.
155
156 Q: Okay. Um, and so at that time you're -- you're thinking that you deployed a
157 stinger ball?
158
159 A: Correct.
160
161 Q: And up to the time until we talked a little bit on Friday about us needing to
162 talk to you again you had no idea that anything but the sti- stinger ball was
163 deployed?
164
165 A: Correct.
166
167 Q: Um, I have some pictures here. The first one is mark number one and it, uh,
168 nylon vest with two canisters in there. Do you recall that?
169
170 A: Yes. That's the vest that CDC brought down to us.
171
172 Q: Okay. Do you know what those two...
173
174 A: Those look like the speed heat canisters.
175
176 Q: Okay. And number two it looks like it is a picture of the speed heat canister.
177
178 A: Yes.
179

- 180 Q: Can you see back here it looks like someone's hand is on a ball?
181
- 182 A: Yes.
183
- 184 Q: Do you know what that is?
185
- 186 A: That? Well it looks like the, uh, stinger ball or it could be a hand ball. I can't
187 say for sure.
188
- 189 Q: Okay. And number three here is – I'm not sure if that's where it was left – the
190 vest or not, um, in the back of I would say (unintelligible) travel vehicle?
191
- 192 A: Yeah. This was the first travel vehicle that was in that line. And that is where
193 we left the vest. Um, and remember once they brought it down and we were
194 moved – removed their munitions we never brought it out of the back of the
195 vehicle.
196
- 197 Q: And number four is a little blown up picture of number two from where the
198 hand is there on the ball. And I don't know if you can make it out any of what
199 the writing is.
200
- 201 A: Well that looks like it says CS and it looks like there's two L's over here so it
202 would be a handball.
203
- 204 Q: Okay. And the two others that we're gonna show you for pictures – I'm
205 gonna show you two. Number five is a handball and number six is a stinger
206 ball (unintelligible) is what it said. Did you see either of those on the vest?
207
- 208 A: Uh, I believe it – it was a stinger that was given to us. Um, we didn't go
209 through every pocket on the vest. Like I said, I asked that, uh, just the stuff
210 that was rated for in-door use be removed the vest. I was never actually in
211 possession of the vest. Uh, that was between Deputy (Barney) and, uh, like I
212 said CDC's team leader.
213
- 214 Q: Okay. Um, and have you ever, um, the handball is a – what's that used for?
215
- 216 A: That's for outdoor use, uh, and it's another way to deploy chemical agent.
217
- 218 Q: Okay. And is that – in that – does it shoot out a flame or?
219
- 220 A: I don't think it shoots out a flame. Um, the only time I – I've seen it used is
221 that video that I watched in your office. Uh, and it looks like that it just, uh,
222 shoots out gas.
223
- 224 Q: Mm-hm.

225
226 A: It doesn't have – have an explosion like the stinger does.
227
228 Q: When you seen the stinger goes off what's left of the (unintelligible)?
229
230 A: Nothing.
231
232 Q: Nothing. And, um, as far as you know I – you guys have stinger balls up there
233 at – at the site?
234
235 A: Yes. We have some in our inventory.
236
237 Q: Okay. And as far as you know were any of those grabbed or anything?
238
239 A: I don't believe so.
240
241 Q: Okay. Now going back to the transaction between – was it mainly you and
242 the CDC guy?
243
244 A: I told him what I wanted. He brought the vest down and I told him
245 specifically I didn't want anything (unintelligible) than our team as we made
246 our approach that wasn't rated for indoor use.
247
248 Q: Okay. Was there anybody else around you guys when that occurred?
249
250 A: I believe my entire team was standing there because I was working on the plan
251 to make the approach and then, uh, it was probably like I said Deputy
252 (Lesarro), uh, Deputy (Jesse Taylor), (Jamie Barnum), maybe (Brian Taylor)
253 was standing there. CDC at that point had, uh, assumed a cover position on
254 the number four side while we were gearing up, getting ready to make our
255 approach.
256
257 Q: Okay. And so during that time wa- was there any other CDC guys around just
258 besides the team leader?
259
260 A: Uh, there were some guys there. I don't know any of their names and I don't
261 know how close they were or whether or not they heard this happening.
262
263 Q: Okay.
264
265 Q1: Just confirming. Deputy (Barney) is actually the person who threw the – what
266 you believe to be a stinger ball?
267
268 A: Yes.
269

270 Q1: Um, is there CS in a hand ball and a stinger ball or just the hand ball? How
271 does that work or do you know?
272

273 A: I believe the stingers can come either just with rubber pellets in it or with
274 rubber pellets and CS or OC. Uh, and as far as – a hand ball doesn't deploy
275 any rubber bullets at all. It is purely chemical agents only.
276

277 Q1: Got it. I think the answers (unintelligible) had. That's a lot of help.
278

279 Q: Okay. Um, so as far as you were concerned Brian the – if you would've been
280 handed that hand ball you weren't gonna use that at all?
281

282 A: Correct.
283

284 Q: And as far as you know you were given the stinger ball and that's what
285 (Barney) threw in?
286

287 A: Correct.
288

289 Q: Have you got anything else?
290

291 Q1: I don't have anything else.
292

293 Q: What about you Brian anything?
294

295 A: That's it. I mean like I said, uh, I specifically asked for things that were rated
296 for in-door use. And the reason I wanted the stinger ball was because I was
297 concerned that if he was in that main living area as we were gonna deploy gas
298 (unintelligible) give him the opportunity to shoot at us again so I wanted that
299 deployed first before we introduced the chemical agents to get him out of that
300 area.
301

302 Q: Was that told to the team leader?
303

304 A: Yes it was.
305

306 Q1: Okay. I don't have anything else than.
307

308 Q: End the interview at 1050 hours.
309

310
311 This transcript has been reviewed with the audio recording submitted and it is an accurate
312 transcription.
313

Signed _____

1
2
3
4
5
6
7
8
9
10
11
12
13
14
15
16
17
18
19
20
21
22
23
24
25
26
27
28
29
30
31
32
33
34
35
36
37
38
39
40
41
42
43
44
45

INTERVIEW WITH GEORGE CAVINTA

Q= Det. Rich Schlesiger

Q1= Inv. Steve Dunn

Q2= [REDACTED] [REDACTED]

A= George Cavinta

Q Okay the date is June 8, 2007, it is 1131 hours, case 200703162. We're in the sheriff's office conference room. Present is Detective Schlesiger, Investigator Dunn and Lieutenant George Cavinta, what's your middle initial, George?

A D.

Q And your PIN number?

A Oh five two seven.

Q Okay and obviously we've been assigned to uh, investigate an officer involved shooting regarding what had occurred on June 3 on Bloody Camp Road at the [REDACTED] Ranch which involved [REDACTED] [REDACTED] Um, h-how long have you been with the sheriff's office?

A Since 1984.

Q Okay and you're currently a lieutenant in charge of what?

A Criminal Investigations.

Q And any other duties?

A I am also the commander of our Explosive Ordinance Division, EOD, a Special Enforcement Team, which our Crisis Response Team has two commanders and I command only the tactical division of our Crisis Response Team.

Q On the um, negotiation side what is it (Moorey)...

A Lieutenant (Moorey) who was not present on the onset uh, was the prior commander, Lieutenant (Steve (Knight)).

46
47 Q And um, as far as uh, SET or SWAT, um, what - how long have you been a
48 member of that team?
49
50 A I've been - I was operator in I believe 1989.
51
52 Q And have you been so ever since?
53
54 A Correct.
55
56 Q Give me uh, you started off as - as wh- do you have any specialties in
57 anything?
58
59 A No I was an entry uh, operator up until the time I became I team leader. I
60 believe that was in 1997.
61
62 Q Did you go to training for team leader?
63
64 A In 1997 uh, yes.
65
66 Q Okay and what about, I don't know what you call it as commander of it, is
67 there any other training?
68
69 A In about uh, 2003 I attended a course FBI uh, commander school in
70 Monterrey, California for team commanders - 40 hour course, the team leader
71 was also a 40 hour course as the basic SWAT back in 1989 was a 40 hour
72 course.
73
74 Q So being the commander you are in charge of all the um, the whole entire
75 tactical team.
76
77 A That's correct.
78
79 Q A- and can you tell me your team and what their current assignments are?
80
81 A We have three sergeants on the team. We have not broken the team into um,
82 designated sticks. We have currently 12 members and um, of those 12
83 members there are team leaders throughout. Sergeant (Miller), Sergeant
84 (Quenelle) and Sergeant (Garcia) are all designated team leaders and who
85 have attended or is going to attend uh, the team leader course.
86
87 Q And do you have any snipers?
88
89 A We have uh, Deputy (Ireland), Deputy (Bishop) and Sergeant (Miller) on our
90 counter sniper teams.

- 91
- 92 Q And as far as gas people or grenadiers?
- 93
- 94 A Sergeant (Miller) is uh, a longtime standing, I think he's been on the team at
95 least eight years and he was an original grenadier. Um, Deputy, I believe it's
96 uh, (Brian Taylor), and (Barney) -- (James Barney) is the other two new
97 grenadiers who have received training in the last year.
- 98
- 99 Q And as far as uh, SWAT team training with guns or other trainings, th- you
100 know, qualifications and training, do y- you guys document that?
- 101
- 102 A Yes we have ongoing monthly training, ten hours monthly and all of that's
103 documented with our training section.
- 104
- 105 Q Okay and on um, June 3 when all of this occurred, um, how did you become
106 notified of what was going on?
- 107
- 108 A Um, June 3 was a Sunday, it was a regular day off and I do not have - I did not
109 have the uh, the duty. I got a phone call somewhere around 400 from
110 Lieutenant (Knight) who was the on-call duty officer for the weekend and he
111 just informed me that the situation was occurring in the Hoopa area and that
112 he had already been in contact with the sheriff, described the details and was
113 advising me as the team commander that the SWAT Team Special
114 Enforcement Team had been uh, requested and that they were in route.
- 115
- 116 Q Okay. And in route to where?
- 117
- 118 A Well what I gathered was a residence on um, Bald Hill area of Hoopa, was
119 given directions out to Pine Creek Road uh, several miles, there was a stop
120 sign turn right that is uh, Bloody Camp Road and up before the cross between
121 the uh, radio station tower and the uh, very large structure cross at the top of
122 Bald Hill there is a road and off to the left. I was advised it was in that area.
123 If and when in route I can be easily notified how to get in there.
- 124
- 125 Q So y- you did not respond to the sheriff's office?
- 126
- 127 A I did not.
- 128
- 129 Q Okay. And d- did you team members do that?
- 130
- 131 A Uh, the teammate members were given uh, commonly what we try to do is
132 have all the units uh, they are paged, called at home, cellular phone, they are
133 contacted, advised what color we are wearing as far as our tactical gear. I
134 believe that day they were told it was a camouflage as this is an outdoor
135 wooded scene. Uh, they on their own deploy - deploy the trailer. They

136 responded here, I had conversations with Brian (Quenelle) that uh, he was
137 taking care of the deployment from the office to the scene. So there's some
138 logistics as far as who was picking up the set trailer, Deputy (Fulton) was
139 given that duty as a take home special services truck, he was able to grab the
140 trailer and proceed up to the scene.

141
142 Q Okay. And um, so you responded by yourself then?

143
144 A Correct.

145
146 Q Okay. And when you uh, made it up to Bloody Camp Road, have you heard
147 that it's somewhat called the () Ranch area?

148
149 A We- when I somewhat throughout the weekend I gathered it was - there was
150 no um, physical address for that location. It's a uh, driveway that belongs to
151 ().

152
153 Q Okay. And when you arrived on scene what did you do?

154
155 A When I arrived on scene, I- I had several conversations throughout in route. I
156 had a conversation with yourself, a conversation uh, with Lieutenant (Knight)
157 as far as making sure the directions were clear on how to get there. Um, when
158 I got on scene I was met by Deputy (Mabree) at the post, there are a set of
159 posts at the left turn to the driveway and uh, there were two civilian vehicles
160 there, I cannot describe them and um, Deputy (Mabree) requested that I speak
161 to the mother, () and the father, (), who were on scene and describe
162 what was going to happen or what was going on at that time. Understand that
163 this had been going on for an hour and a half, almost two hours, already with
164 units deployed around setting up perimeter and setting containment on it and
165 the mother had an opportunity to get up to the scene and was obviously
166 concerned what was going on.

167
168 Q Okay a- and after that?

169
170 A I talked to () and described that um, our position was that we
171 were going to work up negotiations with her son. She described that her son
172 was inside this residence and it was uh, information that was gathered very
173 briefly but she uh, () explained to me that her son was in uh,
174 recently released from (), um, information that he was transported
175 to () for his uh, uh, odd behavior. Was in () for a time
176 - of course these timelines I cannot verify even to this date the timeline when
177 he actually went in and when he was released but it was very current to recent
178 to the time that I talked to her. But he was taken to (), he c- he uh,
179 was involved in some activity that required Eureka Police Department to get
180 involved. He was transported to the jail uh, booked on a - some felony

181 charge. The jail [REDACTED] and uh, released from
182 [REDACTED] uh, in the same state condition [REDACTED] that he was taken
183 in. She was very upset about the fact that [REDACTED] had released him so
184 early and uh, without really assisting him. And that was her major concern
185 and also of course of how negotiations - she was very concerned about how -
186 what we were going to do and I explained to her very clearly that uh,
187 negotiations are primary uh, concern and our goal to reach a peaceful
188 resolution.

189
190 Q Okay. And uh, b- both times you arrived was there any other SWAT officers
191 arrived or had they already arrived?

192
193 A Uh, they were arriving. (Brian Taylor) is an operator uh, assigned to the team
194 who resides in the Willow Creek area I believe. Uh, he was on scene.
195 Sergeant (Miller), I believe, was already on scene. He responded uh, he is a
196 former Hoopla resident Sergeant. He is currently assigned to the north area
197 command and he responded from the uh, north area so I believe he was ahead
198 of me. There was an original responding unit that were on scene and as I was
199 talking to ([REDACTED]) and I do not recall the father's name, ([REDACTED]), the
200 biological father who was divorced from the mother, I had an opportunity to
201 talk to him also but as I was prior - I probably talked to him for about three or
202 four minutes prior to other units arriving on scene so within a very short
203 period of time I spoke with ([REDACTED]) and the biological father.

204
205 Q Okay and um, after speaking with them, did anything occur?

206
207 A While I was talking to ([REDACTED]), I believe, uh, it was uh, or audible gunshots
208 uh, were heard from that area down the road approximately quarter mile, 400,
209 500 yards, to the west of our location.

210
211 Q Okay and how many shots did you hear then?

212
213 A Uh, several. I c- could not tell if I - it was more than o- more than one, less
214 than ten.

215
216 Q Okay. And did you - what did you do next?

217
218 A I advised the parents to stay there and that I had a responsibility to start
219 establishing uh, a better perimeter and containment on the property and that I
220 had to go to work.

221
222 Q Were you notified of if any of our officers were tribal or deputies that couldn't
223 fire.

224

225 A They advised that Deputy (Taylor), (Brian Taylor), was up at the lead vehicle
226 and that he returned fire.
227
228 Q Okay. Let me show you a sketch here, just uh, so you can point stuff out to
229 us...
230
231 A Mm-hm.
232
233 Q As we go along, um, house, Hoopa Valley cars and evidently these are the two
234 main vehicles but there was quite a parade behind them.
235
236 A Correct.
237
238 Q Okay. Um, after the shots and d- did you uh, drive somewhat down the road?
239
240 A I proceeded down the road and I uh, ran into the caravan of cars that were
241 ahead of me while I was talking to Jackie and uh, the mother, and the
242 biological father, several units arrived on scene. One of the units arrived on
243 scene was Sergeant (Freely). Sergeant (Freely) is a resident sergeant assigned
244 to Hoopa and he's also one of the negotiators for the team. So, I was able to
245 um, introduce the two and he began gathering information and I don't know
246 how long he stayed with them after the shots were fired. But um, there was
247 quite a caravan of cars down there and I would only assume that I was
248 probably car number 6, 7, 8, 9 behind in the stack, probably even more than
249 that.
250
251 Q Okay at what point did you take charge of uh, the scene?
252
253 A Sergeant (Miller) was um, he assumed I'd see once uh, he arrived on scene.
254 Deputy (Greg Barry) was one of the initial responding and obviously in an IC
255 system at that probably time there was probably some confusion who was in
256 charge but uh, Sergeant (Miller) had assumed command when he arrived on
257 scene and I believe it was probably about 18, I thought it indicated somewhere
258 in some notes that um, A7 assumed command. It was immediately after the
259 first shooting.
260
261 Q Okay. And um, how were you communicating with everybody that was on
262 scene?
263
264 A I pretty much had a visual on everyone involved at that time, other than um,
265 tribal units, I believe they were Yurok units that were on the um, north side -
266 east side of the structure and we go back to your diagram which you've
267 discussed probably with uh, numerous folks and the numbering system on the
268 diagram and the fact that north is pointed on the number two side of the
269 structure, is that correct?

270
271 Q Yes.
272
273 A Okay, so tribal units were covering the three side up on the hill slope, I never
274 had visual of them and Deputy (Barry) and I believe (Heather Landrano) and I
275 believe Tribal Officer (Matt Spilino) was on the number two side on a hill side
276 on the road between [REDACTED] residence and this residence and
277 Mr. [REDACTED] was barricaded in.
278
279 Q Okay.
280
281 A And um, the rest of my team was still stacked on the main road going in to uh,
282 the residence behind the two Hoopa Valley Tribal Vehicles that were in the
283 number one and number two position, I believe those are both Ford
284 Expeditions marked.
285
286 Q1 George, on this house - did you observe the house when you first go there?
287
288 A I was able to get, of course, by the time I finally got down to the scene within
289 60 - 70 yards I believe the closest that I got to it was probably vehicle 45
290 BAT. In front of that position I could see clearly Window A on the four side.
291
292 Q1 Okay and this house was it facing uh, a little different than it is right now?
293
294 A It - it - it is. I believe the driveway comes up more uh, towards the four side A
295 window instead of coming right to left it is more direct on to the house and
296 then veering around it more in this manner.
297
298 Q1 Would you say that the house is cocked a little bit more that way, the four
299 side...
300
301 A Yeah the number two - yeah the number two side would be swung over to the
302 left a little bit more.
303
304 Q Okay.
305
306 A From the number one and two vehicles, the Hoopa Valley vehicles, um, you're
307 looking directly into - onto the number four side.
308
309 Q1 Okay.
310
311 Q And um, what did you do next a- as far as tactically?
312
313 A We needed to get uh, obviously we wanted to start negotiations um, with this
314 individual. We learnt there was no phone, we threw - we weren't able to

315 verify that there was a hardline. There was no uh, cell phone. The only way
316 we were going to start negotiating with this individual to try to get a throw
317 phone to him or some device to communicate with a PA system. Prior to that
318 we put an arrest/react team together um, and our basic - and our team element
319 was uh, on that number four side, Sergeant (Quenelle) um, gathered a stick for
320 that side, Sergeant (Quenelle) gathered his stick for position to relieve and
321 remove uh, (Greg Barry)'s position, (Heather Landrano)'s position and uh,
322 (Matt Spilino)'s. And we did get information that there was a witness. That
323 witness turned out to be later the person who resides in that residence,
324 Mr. (██████████), I believe, and that he uh, was standing by at that location
325 with them so that was pretty important at that time to get them out of there and
326 relive them and set uh, Sergeant (Garcia) in that position with his team.
327

328 Q Okay. And as far as where you had your people sent out, did you know where
329 that was? Which ones were sent where?

330
331 A Uh, on the one two side, on the far side um, who went to go and assist uh,
332 with the removal of that witness uh, I - Sergeant (Garcia) had that stick and
333 I'm seeing notes here of (Lundy), (Brian Taylor), Sergeant (Miller), and
334 Deputy (Fulton) on the one two side, that was - been over on the ██████████
335 ██████████ side of the residence.
336

337 Q Okay.

338
339 A And on the number four side we had (Jessie Taylor) um, (Gomes Marcero),
340 Jimmy (Barney) and the team leader Brian (Quenelle).
341

342 Q Okay. And it - by the time you guys get set up like this uh, did negotiations
343 begin?
344

345 A Uh, they - they began like I can tell you're referring to the log that um, we
346 started a PA negotiations and mostly from that position after an active
347 shooting situation we only have surrenders at that point, surrender orders and
348 (Jason Daniels) and Deputy (Jason Daniels) and Deputy (Mike Freely) were
349 given the details to start negotiations from the lead vehicles at that time and I
350 can tell you when they started the negotiations uh, about 1945 hours.
351

352 Q1 Okay, and did Lieutenant (Knight) ever uh, come on scene?

353
354 A Uh, strike that. I see a note here negotiations have started over the PA at 1905
355 hours.
356

357 Q1 Okay. And did Lieutenant (Knight) ever come on scene?

358
359 A He arrived on scene shortly after uh, after I did.

360
361 Q Okay. And what role did Lieutenant (Knight) assume?
362
363 A He assumed um, he was a logistics planning and running the negotiations part,
364 assisting with that.
365
366 Q1 Okay. So were you passing onto what you needed, like such as a command
367 post or other things?
368
369 A Correct. I- I used Lieutenant (Knight) as if I ran the IC then I used Lieutenant
370 (Knight) as a logistics individual and when I needed something I asked - I
371 requested and I was later informed whether that task would be met um, i.e. the
372 command band was sent up prior to my request.
373
374 Q1 Okay.
375
376 A Um, [REDACTED] th was notified through Lieutenant (Knight) and um, I believe
377 the CIRT request was notified through Lieutenant (Knight) also.
378
379 Q1 Okay.
380
381 Q And um, after all of that goes down and you guys are down here, you're still
382 um, kind of just with your vehicle at that time, no?
383
384 A We- exactly. We were trying to formulate uh, teams. We were trying to
385 establish personnel on scene. Um, tactical dispatchers arrived on scene. Uh,
386 they immediately were put to use as far as grease boarding uh, units on scene
387 and that takes some time. But we were also planning where uh, the incident
388 command post should be established. It was a single lane dirt road with no
389 uh, turnouts available for vehicles to pass by so unfortunately our nearest IC
390 that we were able to plan for and establish was back at the intersection of
391 Bloody Camp and the [REDACTED] driveway.
392
393 Q1 And as far as you communicating with your team leaders once they were
394 mobile, were you using a handheld radio to do that?
395
396 A We were and when we arrived initially on scene units were on (unintelligible),
397 we switched over to [REDACTED]
398
399 Q1 Okay and c- you prior said attempt negotiations numerous times but explain to
400 me the difference between negotiations and uh, surrender orders.
401
402 A Negotiations is when we have o- open dialogue with an individual barricaded
403 inside the house. Negotiations are when we have ongoing discussions with
404 them, a two way conversation is a negotiation. When we have an active

405 shooter in the house as this situation was where we had an individual who fi-
406 who brandished a firearm, later fired a firearm at us and would only
407 periodically yell out um, threats, there were no open negotiations and
408 therefore the only thing we could tell him is that he needed to come out of the
409 residence, surrender, come to the door without any weapons, follow the
410 directions of the nearest officer and surrender. We repeated those requests
411 um, for the 28 hours that we were on scene. It went on over and over.
412

413 Q1 And there was never any contact with him?
414

415 A There was never any return open dialogue from the individual. He returned
416 fire during the negotiations, during the surrender orders. Again later on
417 approximately two and a half, two hours after the initial shooting, while
418 Deputy (Freely) was ordering - was giving surrender orders and there was
419 another shooting at that time.
420

421 Q Okay. Did you learn from the first shooting - when there was the first
422 shooting, where the [REDACTED] was shooting from?
423

424 A They described the number four side, facing uh, to the south, and uh, Hoopa
425 Valley Tribal units that were first on scene were facing that number four side
426 of the house and there were two windows on that side of the house and as we
427 numbered the building that was a number four building and the number - the
428 first window left to right is A on down to the right and there is two windows,
429 the second window to the right was B. We were told that the shooting came
430 from window four A.
431

432 Q1 Okay and um, you mentioned something about a second shooting?
433

434 A While we were still dealing with the logistics of manpower um, getting details
435 on this individual, getting background um, with uh, the on scene negotiators,
436 talking to family members uh, Deputy (Freely) had - was continuing to give
437 surrender orders and I was probably eight to ten vehicles back in the stack
438 when um, Lieutenant (Knight) and I heard a- a- what was most likely a
439 tumbling round through the air over our - in the direction over the top of our
440 heads.
441

442 Q1 A- and can you recall how many shots you heard?
443

444 A We - I cannot. We heard the first - that tumbling bullet sound ruffled air um,
445 pardon me, it sounded like whoooo over the top of our head and it was
446 immediately followed by gunfire, more than one, less than ten.
447

448 Q1 Okay. Was it reported back to you uh, what officers had fired their duty
449 weapons?

450
451 A Uh, it was.
452
453 Q1 Who was that?
454
455 A It was Sergeant (Quenelle), Deputy (Barney) and Deputy (Gomes).
456
457 Q1 Okay did they state how many rounds they had fired?
458
459 A Uh, I did not get that.
460
461 Q1 Did you learn later on?
462
463 A I to this - now I still do not know how many rounds each one of those
464 individuals fired.
465
466 Q1 Okay.
467
468 Q During your communication with your guys, George, were they mentioning
469 anything about movement or talking in the house or anything like that?
470
471 A Ongoing - all throughout the ordeal the first - until 500 a.m. on Monday
472 morning there was reports of movement throughout the house. Uh, seen
473 eating, seen moving about, seen clothes, changing or folding clothing, yelling,
474 sounded like he was talking to himself, talking on a phone, loud thumps inside
475 um, there was one time in early mornings uh, he was yelling about a hand
476 grenade.
477
478 Q Okay. Um, did you guys discuss uh, putting a throw phone in the house or
479 anything like that?
480
481 A We yes - we have all of those and we uh, to set up negotiations to deal with
482 him in dialogue we would have to have deployed a throw phone, some type of
483 device to discuss with him but once the uh, shootings occurred it was very
484 unsafe to approach the residence and to um, deploy a throw phone to any of
485 the windows at that time and we just continued with the surrender orders.
486
487 Q Okay. Did you try the telephone in the house?
488
489 A Uh, we learned that it was disconnected. We through (Willy) - Chief (Willy
490 Hostler), uh, he learned that the phone service had been cut off due to
491 payment. Um, we verified that later on that it was a Verizon phone and that
492 we were hoping to initiate some service, one way service back into the home
493 and then we later learned that there was not even a hard line in the home or a
494 telephone that could pick up the- the service.

495
496 Q Okay.
497
498 A And we had no information about a cell phone. The owner of the residence,
499 one of the residents, has a cell phone and uh, we learned later that when she
500 vacated the residence shortly after the arrival of Mr. [REDACTED] that she took
501 her phone with her therefore there was no communications uh, in the home or
502 any way for him to call out or us to call in.
503
504 Q Okay. After the second shot or shots, what um, was your operation plan from
505 that point?
506
507 A We still worked on negotiations. Once the second shots happened at about
508 900 p.m. um, at that time we were definitely looking for more information to
509 get him to talk to us. We worked throughout the night with that, however, he
510 would never respond to any of the requests from the negotiators at the lead
511 vehicle to - to - talk to us, to yell out the window and um, therefore darkness
512 fell, we stopped negotiations due to the fact that if he came out and he tried to
513 surrender we couldn't see him.
514
515 Q Um, are a - during thi- this time, w- were - did you move your teams to any
516 different locations at all?
517
518 A They stayed in place. The first um, deployment that we had shortly after I
519 arrived and we set those teams in course, they stayed in place until Eureka
520 Police Department arrived uh, at about um, 300 am.
521
522 Q Okay and when - who made the mutual aid to Eureka Police Department?
523
524 A Uh, Lieutenant (Knight) made the request uh, to EPD and I shortly relayed
525 soon after that so probably after the 900 shooting I got a call from um,
526 Sergeant (Nova).
527
528 Q Okay, and did you brief Sergeant (Nova) on what had occurred?
529
530 A I did.
531
532 Q Okay and he agreed to come up?
533
534 A He agreed that uh, he would attempt to deploy uh, to leave Eureka with a team
535 somewhere around 0030 hours, 1230 am.
536
537 Q And was that request mainly to have his SWAT team come up and give your
538 teams a break?
539

540 A That's correct. We needed (unintelligible) so we could look towards the
541 second operational period so they could provide containment and arrest/react
542 duties while we stood down and rested and we were hoping that that
543 deployment would happen around 300 am.
544

545 Q Okay.

546

547 A And that we could come back online at 700 am.

548

549 Q And what time did that occur?

550

551 A By the time EPD arrived on scene and we were able to pull our units offline, it
552 was more close to 500 am Monday morning.
553

554 Q Okay.

555

556 A Looking at your map also in the original deployment of the two sticks, there
557 was no deployment when we arrived, two counter snipers were deployed to
558 the number three side and um, that was Deputy (Ireland) and Deputy (Bishop).
559

560 Q Okay.

561

562 Q1 When you say stick what do you mean by that?

563

564 A Uh, a team of members - operators that move as a group.

565

566 Q1 Okay.

567

568 Q Um, so when you - you guys are relieved um, where do you send your troops?
569

570 A Well we originally looked for um, the hotel in Hoopa. We learned that it was
571 busy, it was full, no vacancy. Uh, some information was trickled back to
572 Eureka um, and we were offered a residence in Willow Creek. However, by
573 the time our team members pulled offline and were given some food, water, a
574 break, they chose to respond to the Hoopa station in downtown Hoopa and uh,
575 take a break there.
576

577 Q Okay. Was that around probably 400 am, 430 when they finally probably got
578 to that station?
579

580 A Uh, probably.

581

582 Q1 Okay. And uh, where did - did you go with them?
583

584 A No I stayed in the command bed and arrived and then sat up in the intersection
585 of Bloody Camp and [REDACTED] Road. I stayed on scene the entire time.
586

587 Q Did you consider your team as still operational while they were at the Hoopa
588 Substation?
589

590 A Were they operational? They were - they were - they were operational and
591 they were in stand down mode.
592

593 Q Okay as far as what I'm saying is g- given a break, maybe a half an hour of
594 sleep they were still [REDACTED] - did you still have uh, communication so you
595 could call them if something did go on that they could return.
596

597 A That's correct. I mean, that's the idea of having them stand down locally. If
598 an incident would have occurred - if the [REDACTED] would have began
599 negotiations we could have pu- put our team back in place.
600

601 Q Okay. Um, so, your - when did you start getting um, back involved at the
602 command post while EPD was still there?
603

604 A I was uh, as a request to Sergeant (Nova), that his units respond only if I
605 stayed on site.
606

607 Q Okay.
608

609 A Therefore uh, I assumed command uh, the entire time so once EPD arrived on
610 scene I still assumed command.
611

612 Q1 And um, when they uh, when your team returns, did you meet with uh, your
613 team leaders?
614

615 A I did.
616

617 Q1 And what did you guys discuss?
618

619 A Well, th- there was a lot of information flowing at that time. The prior
620 evening Lieutenant (Moorey), who is the negotiations commander um, had not
621 responded to the scene, however, had been in contact with the California
622 Department of Corrections Team -- Negotiating Team -- with he and his
623 negotiators have trained with them in the past and that he is aware of their vast
624 experience. He is aware of their um, teamwork and the fact that they have
625 additional resources um, throw phones with uh, audio and video, and they
626 agreed to assist and they were coming from Crescent City, they were meeting
627 with Lieutenant (Moorey) at 600 am in the (unintelligible) area and that they

628 were going to be onsite hopefully anywhere around 730, 800 am on Monday
629 morning.

630
631 Q1 Okay.

632
633 A Uh, the plan with the team leaders is that we continue to uh, uh, discuss the
634 fact that this was an active shooter, that uh, we could only deal at this time
635 with surrender orders and that uh, mental health had been on scene uh,
636 throughout the night and uh, they were advised and uh, agreed that the only
637 negotiations that we had at that time were the surrender orders. He was not
638 committing himself to any dialogue, two way and share information. So uh,
639 we were still in an arrest/react situation with surrender orders only. Once
640 daylight broke again uh, we had units down there um, giving surrender orders.

641
642 Q Which units were that? Was it the CVC?

643
644 A It was the CVC, yes.

645
646 Q Mm-hm. And um, you mentioned [REDACTED]. Did you speak with, I can't
647 remember their names but I know that they were there, the two females.

648
649 A [REDACTED], who is the crisis unit supervisor for
650 [REDACTED]. I had discussions with both of them.

651
652 Q And were they familiar with [REDACTED]

653
654 A They were.

655
656 Q And what did they tell you?

657
658 A Uh, th- that - more so they were concerned about what - where I was going
659 with this. I don't know if they were uh, uh, willing to give too much
660 information about [REDACTED] other than the fact that uh, we shared information
661 that he had gone to [REDACTED] and confirmed that
662 information, that he [REDACTED], [REDACTED],
663 [REDACTED] uh, and that um, the fact that he was not negotiating
664 with us didn't leave a lot of room for [REDACTED] assistance in the situation.
665 Um, whatever information they gathered they weren't able to share or partake
666 in the negotiations because Mr. - the [REDACTED] was not um, opening any lines of
667 communication with us. So when I described to them what our plans were
668 um, the following day uh, they agreed that that was the only action course that
669 we could take.

670
671 Q1 Okay. Did they um, mention anything to you about them trying to talk or
672 anything like that to - to the [REDACTED]

673
674 A No. There was none of that. With that active shooter they were very aware
675 that uh, that the area where the PA system was being used was a hot area and
676 that uh, unless we were able to get a throw phone in there with a line back to a
677 safe area command band staging area would they be able to assist in
678 negotiations.
679
680 Q1 And did they feel - say that was able to happen, they would be able to speak -
681 speak to ([REDACTED] [REDACTED])
682
683 A Absolutely.
684
685 Q Um, so you guys arrived and eventually you g- CVC starts trying to get
686 surrender orders and do you send (unintelligible) back out then?
687
688 A We pulled EPD offline about um, 800 am. That's the best I can recall. Um,
689 on Monday morning there was a, we d- um, we assigned team members to
690 those sticks in an event that we were going to continue on with a plan of
691 introducing chemical agents.
692
693 Q1 And how did you have them set up? W- well, let's back up real quick. Was
694 Lieutenant (Knight), d- did he stay or...
695
696 A No Lieutenant (Knight) uh, I believe, left the scene about t- 200 am, 300 am.
697
698 Q1 Okay.
699
700 A Monday morning.
701
702 Q1 Would you say that's because negotiations stopped and...
703
704 A Correct.
705
706 Q1 Pretty much things had somewhat slowed down, wasn't things going on at the
707 house.
708
709 A Correct. Um...
710
711 Q1 Where did you go with the teams and where you sent them?
712
713 A Again uh, Sergeant (Garcia) uh, was in charge of the side one's - the team two
714 unit, you can call them the team two, and they are assigned to the one two side
715 of the structure. And uh, that was (Garcia) (Miller), (Barney), (Gomes),
716 (Fulton) and (Bishop). And uh, maintained uh, one a team one on a three four
717 side uh, Sergeant Brian (Quenelle) was a team leader.

718
719 Q1 Was uh...
720
721 A (Lundy), (Jessie Taylor), (Brian Taylor), (Ireland) and (Lasaro).
722
723 Q1 Were all at the Hoopa vehicles?
724
725 A Correct. At one point.
726
727 Q And uh, going back to when you met with your team leaders, I don't know,
728 did you guys have game plan of how things were going to progress throughout
729 the day?
730
731 A Um, we were - it was truly a rolling operation. All contingent on the actions
732 of the [REDACTED] We were hoping that uh, we'd get some dialogue to
733 negotiations while the CVC, a negotiating team was in place early that
734 morning starting about 800 a.m. Um, but they abandoned and they realized
735 that there was not going to be any negotiations, they went down and used the
736 PA system, they used the handheld megaphone, amplified, they used the
737 vehicle PA system and after about 30 minutes they realized that uh, the
738 [REDACTED] was not going to negotiate with them.
739
740 Q Okay. And um, did CV - did anyone else from CVC come?
741
742 A They brought a unit from the tactical team. Um, the CVC has a team similar
743 to ours, a crisis response team and it's broken down into a negotiations side
744 and a tactical team. I believe they brought four tactical officers who could
745 assist uh, with uh, a containment in a arrest/react situation.
746
747 Q1 And um, j- just to stay on this - I know we'll cover it later, eventually some
748 more uh, members of their team showed up?
749
750 A I believe five more showed up around uh, 1100 am, noon that day, Monday.
751
752 Q1 Okay.
753
754 Q And um, so when you sent um, those guys out and CVC gives it a try, does
755 anybody else uh, start trying to give surrender o- surrender orders?
756
757 A When we come up with the plan to introduce chemical agents, Deputy
758 (Freely) is put in a position again as a negotiator giving surrender orders. Uh,
759 at that time he gives him a - that uh, a 30 minute countdown...
760
761 Q And he starts...
762

763 A Advising.
764
765 Q Advising, ten minutes left...
766
767 A Yeah.
768
769 Q Five...
770
771 A Correct.
772
773 Q All the way down.
774
775 A Mm-hm. And he was giving, it was an open option, we set options with the
776 [REDACTED] and um, surrender options and surrender orders are is that [REDACTED] has
777 an option to come out and surrender. And um, the directions to Deputy
778 (Freely), or Sergeant (Freely), is that he set the options up, he has 30 minutes
779 to come out of the residence. Um, at that time, there was no information
780 given as to what was happening in 30 minutes. But he had 30 minutes to uh,
781 vacate the residence.
82
783 Q Okay.
784
785 A And that he needed to so in a safe manner and he was given those instructions
786 over and over by Sergeant (Freely), who uh, you already know, recorded I
787 believe all of his surrender orders um, each time that they were given so I
788 understand there is up to eight tapes that he gave over that uh, 28 hour period,
789 any time that he used his PA system he was recorded it on an audiotape.
790
791 Q1 Okay and when the decision was made to use chemical gas um, was EPD a
792 SWAT team deploy?
793
794 A Sergeant (Nova)- we- used his team to assist on the number three side.
795
796 Q1 Okay.
797
798 A And I was able to um, um, better contain and to utilize their resources if
799 needed.
800
801 Q1 Did they also have a gas mask?
802
803 A They do.
804
805 Q1 So they get um, they go out and th- the countdown (Freely) gives to the
806 [REDACTED] and there's nothing going on there. Did you ever hear anything from
807 your members that they hear anything or see anything?

808
809 A There was movement in the house again. Um, and I don't recall what that was
810 but there was movement in the house.
811
812 Q1 Okay. And do you know what time you guys began to introduce gas into the
813 trailer?
814
815 A I can't - I can check my - the log. We had several deadlines set as far as
816 deployment but I halted those several times due to logistical situations with
817 the requested helicopter that I wanted on standby on the scene should it be
818 needed for medical evacuation so um, it was pushed back the timeline, the
819 original timeline I believe was 1000 am. Um, and it was pushed back several
820 times on this (unintelligible) operation. And um, delivering options began at
821 1048 by Sergeant (Freely). It looks like delivering options to [REDACTED] and that
822 is the countdown to 30 minutes, he has about 30 minutes to leave the
823 residence, surrender. They were given the order to proceed with the delivery
824 of chemical agents at uh, 1120, approximately 1120 hours.
825
826 Q1 Okay and is that decision yours?
827
828 A Yes.
829
830 Q1 A- a- and I'm guessing you went through (Brian)?
831
832 A Correct.
833
834 Q Okay. Did you know who was going to deliver the agents?
835
836 A Either D- Deputy (Barney) or Deputy (Brian Taylor).
837
838 Q Okay did you make the decision on - or did somebody else, on how many uh,
839 volleys or rounds were going to go where and that?
840
841 A Um, it was a decision with the Det- Sergeant (Nova), myself um, Detective -
842 with Sergeant - with Sergeant (Quenelle) and Deputy (Barney) that I wanted
843 the calculations on this residence for saturation and again with some
844 background in chemical agents uh, I was aware and confirmed with Dep- with
845 Deputy uh, (Barney) that due to open windows, broken windows that we
846 weren't going to reach saturation point in this residence, meet the levels of
847 saturation. So I made the decisions to go ahead and pump ten 37 millimeters
848 of uh, barricade projectile gas into the number four side of the residence.
849
850 Q Okay. So, ten w- explain to me ten.
851

852 A Ten independent 37 millimeter barricade projectiles were shot from a single
853 (unintelligible) from the vehicles from the Hoopa Valley travel area, last - I
854 think they recorded a distance of 51 yards and uh, they were given orders to
855 shoot uh, five in A window and five in the B window to introduce uh, the
856 chemical agents into the residence to hopefully get enough irritant in there to
857 persuade the [REDACTED] to leave the residence.
858

859 Q And were they successful as far as you know of getting five in each window?
860

861 A Uh, the success rate later I asked on our side, on the - deployed by our team,
862 was um, good. And that's what I got that. I don't know if that was a 100%
863 but according to Sergeant (Cornell) it was a good ratio of uh, of the first
864 volley of ten to go in.
865

866 Q Okay. Was there any other volleys then?
867

868 A We waited uh, another ten - fifteen minutes with no response, no activity in
869 the home that um, no movement, that um, we sent a second volley of ten, five
870 in the A window, five in the B window.
871

872 Q1 Okay and shot by one of your two guys on that?
873

874 A Correct.
875

876 Q1 Okay.
877

878 Q A- and d- I just want to get clarified, George. They shot, as far as you know,
879 as many as they had to to get five in each window, I mean they weren't just
880 shooting five in, five in and then five in and five in, they had to - you wanted
881 five a total of, 20 now...
882

883 A Correct.
884

885 Q You wanted them in that window.
886

887 A Correct, correct, correct. That - that was my request to go in there. I later
888 learned that when EPD was attempting theirs on the number two side that that
889 ratio was uh, was not good and that the distance that they were firing was a
890 too great therefore the ten was requested on the number two side by EPD, the
891 success rate was very poor.
892

893 Q Okay. And after this second volley, is there any response from the house?
894

895 A Um, there - there's a notation and I do recall that uh, um, there was sounds of
896 broken window on the side one side and it says here just advised [REDACTED]

897 crawling on the ground near the master bedroom on the number two side and I
898 do re- remember hearing um a radio transmissions that the [REDACTED] had a
899 blanket over him and was crawling, something to that.

900
901 Q Okay. What happened after the second volley?

902
903 A After the second volley, I requested that EPD um, attempt to get in a position
904 of the number two side and since Deputy um, (Bishop) reported seeing that
905 movement on the number two side, I assumed that we had driven him from
906 the fourth side to the opposite side of the house, therefore we wanted to
907 introduce some chemical agents on that side of the building.

908
909 Q1 Okay. And George, what was you guys' plan, where did you want the [REDACTED]
910 to come out at?

911
912 A The front door. I mean, any door or any command that he was told to come
913 out there was the front door planned, obviously since we had units in position
914 there to assume surrender orders once he did appear. However, all the units
915 were prepared in an arrest/react situation just to uh, to uh, take command if he
916 does exit from any uh, exit on the building.

917
918 Q1 Okay.

919
920 Q So EPD unit moved to position on the number two side?

921
922 A Mm-hm.

923
924 Q And how many did you want them to put through, or I don't know, window or
925 windows on the number two side?

926
927 A I believe it was ten more.

928
929 Q Okay. And you said that they had a poor uh, accuracy rate?

930
931 A They had a very poor accuracy rate. They - they uh, later broadcasted that it
932 was um, they were proceeding past they had three in the room, they are
933 pushing the limits of their equipment. They have three more now and it's
934 unknown if they delivered any - I think they recognized the fact that they were
935 having a difficult time getting ten into the house and that at 1224 they advised
936 that they had four in at that time.

937
938 Q Okay. Did you have them shoot anymore?

939
940 A Uh, there was - I wished that uh - I requested that they move position on the
941 three side, there are two doors that I was informed of on the number three side

942 of the building uh, that's a hallway leading from the kitchen area back to the
943 bedroom. Understand that only uh, understanding or knowledge that I had
944 about the structure was by diagrams provided to me by uh, tribal police and
945 confirmed by the owners of the residence so therefore there wasn't
946 (unintelligible) from the number four side back to the master bedroom on the
947 number two side and that somehow we could introduce uh, uh, some chemical
948 agents into those bedrooms between that area had he been held up into the,
949 what was described as a bathroom and then a third bedroom and therefore we
950 tried to come into the number three side. But uh, apparently there was some
951 difficulty and it's unknown whether it actually got into shots into the - on the
952 number three side.

953
954 Q Okay and um, during this whole time, Sergeant (Freely) still trying to get
955 some type of reaction from the [REDACTED]

956
957 A That's correct.

958
959 Q And uh, what is - what occurs next?

960
961 A Uh, there was just - it went on for a period of time where we attempted to uh, I
962 believe there was another request uh, for um, additional ferret rounds into the
963 house and due to a crosswind reported by um, Sergeant (Quenelle) was going
964 to be difficult to do so they went to a 12 gauge ferret rounds and fired what
965 they - what I believe was ten rounds of ferret rounds into the number four side
966 of the residence.

967
968 Q Okay five and five again?

969
970 A I believe so.

971
972 Q1 Okay and how many times did that occur? How many volleys?

973
974 A That was one more volley.

975
976 Q1 And that was it?

977
978 A Uh, until we introduced canisters.

979
980 Q1 Okay uh, why did you guys not shoot anymore of the 37 millimeter?

981
982 A Uh, we - that was 30 rounds shot into - approximately 30 rounds fired into this
983 - into, at or attempt and uh, truly we thought of another plan to introduce
984 chemicals by way of castor.

985
986 Q1 Okay.

987
988 Q And um, as far as shooting the shotgun ferret rounds, do you recall if those
989 burst CS and OC?
990
991 A I don't recall.
992
993 Q Okay. Um, was there also another reason for shooting the ferret rounds into
994 the windows?
995
996 A We're trying to - discussion with Sergeant (Nova) and I had was they could
997 um, um, on the EPD side of the number three side that there was a request one
998 time that they shoot the window out with a ferret rounds and it was unclear if
999 that was ever successful.
1000
1001 Q Okay.
1002
1003 A To utilize the 12 gauge ferret rounds to penetrate the windows and then they
1004 could proceed with the 37 millimeters at a greater distance.
1005
1006 Q Okay. And um, so you had your guys - did you have your guys shoot out the
1007 windows with the ferret rounds?
1008
1009 A Yep those windows - Window A was already broken out from what I
1010 understand and Window B had the initial volley of five, they would have been
1011 broken out with the first volley.
1012
1013 Q Okay. And then you just did the ferrets, five and five...
1014
1015 A Mm-hm.
1016
1017 Q And then you said something about canisters?
1018
1019 A Mm-hm.
1020
1021 Q Why were you going to go to canisters?
1022
1023 A We had better dispersion on the dispersion rate on the uh, canisters and uh,
1024 some discussion with Sergeant (Nova) and myself determined that we could
1025 put in a higher level of saturation with the canisters.
1026
1027 Q Okay.
1028
1029 A They contain by volume more of the chemical agent product.
1030
1031 Q Okay. And did you then do that?

1032
1033 A Uh, a plan was made to have Sergeant (Quenelle)'s team located on the
1034 number four side put together a- a approach team. Some discussion with CVC
1035 was done and assistance was provided with some bang pulls, pull - some fire
1036 pulls um, off the fire truck and a ballistic blanket provided by CVC. They
1037 moved those items up to the location of Sergeant (Quenelle)'s position and
1038 they worked on a plan to approach the number four AB windows and deliver a
1039 canister into the A window and a canister of chemical agents into the B
1040 window.
1041
1042 Q Do you know what chemical agents were uh, pushed into the AB window?
1043
1044 A CS gas.
1045
1046 Q And do you know what - was it a pyrotechnic or nonpyro?
1047
1048 A Nonpyrotechnic.
1049
1050 Q And do you know the name of them?
1051
1052 A I do not.
1053
1054 Q Okay. Um, as far as you know they go - they go up there and those two
1055 canisters are delivered through the A and B window by someone on that
1056 team?
1057
1058 A Correct.
1059
1060 Q Okay. And then they return to uh, the tribal units?
1061
1062 A Correct, 1340 hours, Deputy (Freely)'s advising the command that uh, gas
1063 inserted into Window A and Window B and we start the surrender commands
1064 again.
1065
1066 Q Was there any response?
1067
1068 A No response.
1069
1070 Q Okay.
1071
1072 A There was product discharge, I confirm that there was product discharge at
1073 1344 hours um, it was confirmed there was a good insertion and not much
1074 blow out through the open windows on that side.
1075
1076 Q1 Who confirmed that?

1077
1078 A Uh, Sergeant Cornell.
1079
1080 Q1 Okay.
1081
1082 Q Still no response from inside uh, what do you guys do next?
1083
1084 A Uh, we continued to saturate this residence. Uh, coming up with plans to
1085 introduce more chemical agents to make this as unbearable and uncomfortable
1086 to drive him out with irritant and we're looking at operational period RA that
1087 was going on and on and uh, Lie- Sergeant (Nova) and I had started having
1088 discussions at that time uh, whether we could proceed with the resources that
1089 we had there for another operational period. Um, we decided to insert another
1090 two canisters in the AB windows on the four side and um, there was talk about
1091 pyrotechnics, it was a very brief discussion as that if we had any and we did
1092 an inventory at that time and I can see that timeline is around 1353 hours.
1093 Sergeant (Nova) and I discussed that uh, we're not in a position yet to
1094 introduce pyrotechnics but should the [REDACTED] uh, begin his active shooting
1095 has he done it prior two occasions during - during a delivery of the canisters
1096 that would be nice if we had the pyrotechnics available to us.
1097
1098 Q1 And did anybody have any - di- did the SO or the EPD have pyrotechnics?
1099
1100 A SO and EPD uh, did not have any pyrotechnics uh, flammable, CS gas
1101 canisters at that time.
1102
1103 Q1 Okay. And did - did the SO or EPD ever get any?
1104
1105 A CVC came up uh, with um, two canisters of speed heat that they showed us in
1106 the command van and I- uh, Lieutenant (Hager), the commander of the CVC,
1107 had been in the command several times and the commander up there of that
1108 unit showed us uh, two speed heat balls that were uh, more intent used for the
1109 purpose of the yard, it creates uh, high heat and we recognized that we had
1110 those available to us, that uh, he did show us two more canisters that were uh,
1111 continuous release CS and I believe OC aerosol and we pushed those up to the
1112 team by way, from what I understand, they delivered a vest up to um,
1113 Sergeant (Quenelle)'s position. Sergeant (Quenelle) took an inventory of that
1114 stuff was described what he had in the vest, put the pyrotechnic stuff back in
1115 the vest and sent that stuff back up to the command post. That's from what I
1116 understand took place.
1117
1118 Q Okay. So on the second time, the same team goes up again that you had
1119 before, right?
1120
1121 A Correct.

1122
1123 Q Okay and util- utilizing the same way you had before?
1124
1125 A Correct. They established a stick utilizing the - the pull pipes and uh, ballistic
1126 blanket and were able to get in a position to throw two more canisters in, one
1127 in A window and B in the B window.
1128
1129 Q1 And these were aerosol canisters?
1130
1131 A That's what it was described - yes.
1132
1133 Q1 Okay. And so they come up and throw one in the A and one in the B.
1134
1135 A Correct.
1136
1137 Q1 And return?
1138
1139 A Correct.
1140
1141 Q1 Did you ever hear anything about uh, sting ball? Or stinger ball?
1142
1143 A No, other than - other than the speed heat that was showed in the van to
1144 Sergeant (Nova) and myself are similar devices we've seen in the past, sting
1145 balls, they're round um, device, looks like a ball and that's what their speed
1146 heats look like. But as far as us deploying a sting ball, no direction was given
1147 for that.
1148
1149 Q1 Okay. Um, they return, was anything else going on at the house besides
1150 (Freely) still attempting surrender orders?
1151
1152 A This entire time I was in the command van 400 some yards away. Um,
1153 looking at the situation and with Sergeant (Nova) looking at our operational
1154 time I realized how much agent we had in that house and the fact that we were
1155 unsuccessful in getting him to negotiate with us or to surrender and that
1156 several options were at hand and one of them I discussed with Sergeant
1157 Cornell was to come up with a port plan of porting windows and um, that I
1158 don't know how far along he got with that. Some time after the last...
1159
1160 Q1 Let me stop you for a second.
1161
1162 A Okay.
1163
1164 Q1 What's the reason to do that?
1165

1166 A We would por- in an active shooter situation, we would not do a dynamic
1167 entry into this residence, we would not send the team in the front door, rush
1168 the house, as a common drug bust type of entry, a SWAT team hostage
1169 situation, we have a barricaded [REDACTED] who was actively shooting and it
1170 would be a suicide mission to send a team into this residence knowing the
1171 firepower that he had in this house, the weapons available to him and his
1172 actions that he took prior to this incident. So, we would port and porting is
1173 much like looking into a car without ever having to get into it and the house is
1174 the same way. If we can bust out the windows, if we can stick out, if we
1175 could stick a pole cam in the window, eliminate him from one area of the
1176 house and concentrate into other areas of the home without ever entering the
1177 house, porting is searching without entering.
1178

1179 Q Okay. And go ahead and go on from there when you guys discussed what else
1180 you were going to do after porting?
1181

1182 A Well I decided that to go up and take a look at it a little closer. I realized and
1183 the entire time I was there that that area where the two vehicles were at was a
1184 hot area. Everybody who had been in that area had been wearing ballistic
1185 gear and helmets and that it was open to that number four side but I um, and I
1186 believe Sergeant (Nova) accompanied me up there, where I was - I wanted to
1187 work on the second operational period and that I wanted CVC and I requested
1188 that CVC um, and this was occurring pretty fast. CVC agreed when asked if
1189 they could cover uh, a containment in the arrest/react team on this site from I
1190 believe I sat the timeline from 500 pm Monday until 700 am Tuesday morning
1191 and I requested that if they had s- if they resources that they could conduct
1192 that um, request for us and uh, the commander for the CVC agreed that he
1193 could handle the containment on all four sides of that house until 700 am
1194 Tuesday morning. My goal at that time was uh, uh, move pretty fast from us
1195 gathering some pretty heavy duty equipment, tow trucks, cables, chains, um,
1196 uh, grapple hooks, that the following morning I would come up with EPD and
1197 SO units fresh off of over 12 hours of rest, almost 12 hours of rest, that we
1198 could work on a mechanical porting of this structure and it's a single wide,
1199 dou- it's a modular unit with a add-on, it makes it a little L shape. Therefore,
1200 it just started going through our head and discussing the fact that we still
1201 weren't going to send the dynamic entry team in, the fact that he was still
1202 refusing uh, to exit, I started formulating that plan to do a mechanical port of
1203 this building and that was literally just to pull walls down with some type of
1204 heavy device. Something triggered and I requested the Sergeant (Hanson),
1205 who was on the scene to contact the FBI to see if they'd be willing to assist
1206 and shortly, shortly after that request I got a phone call from uh, Special Agent
1207 (Fagan) and uh, who put me in touch with a agent out of San Francisco. At
1208 that time, I just requested two peacekeepers I know that they have, their
1209 tactical team and I asked if they could be available and be on site by 700 am
1210 and that was a plan that we truly at that point - I was looking, not that we had

1211 exhausted our um, resources on this but was looking for um, other options to
1212 um, approach safely, introduce more chemical agents safely and if needed, use
1213 their four wheel drive peacekeeper vehicles to hook onto windows, door jams,
1214 posts, doorways, to start um, porting this trailer.
1215

1216 Q1 Okay. That did not happen?

1217
1218 A That did not happen.
1219

1220 Q1 Okay, what happened then?
1221

1222 A I - as I was standing there uh, with the team one, I got in from talking to the
1223 agent in San Francisco, I told him to hold on, that uh, I'm being notified that
1224 the structure that there is smoke coming from the structure. And the word
1225 from the team one was that it was definite smoke coming from Window A and
1226 Window B.
1227

1228 Q1 Okay and did you go down there at that time?
1229

1230 A I was standing there at that time. All I had to do was look up and confirm that
1231 there was a- a puff of smoke coming from A and B and immediately ordered
1232 (Freely) to continue with the surrender orders.
1233

1234 Q1 So it wasn't like the smoke CS at that time, a white smoke, it was a black
1235 smoke?
1236

1237 A It was a light smoke mixed in with a darker smoke that was um, it would
1238 bellow at times and then cease at times. It would - I made several comments
1239 that it's going to blow itself or whatever it is - it's blowing itself up because I
1240 don't see a lot happening here. Um, however, um, it continued to bellow. It
1241 would die down to no smoke and then it would bellow out the A and B
1242 windows again and each time more, increase volume of smoke and more
1243 increase volume of the black smoke.
1244

1245 Q1 Did uh, did you witness any flames?
1246

1247 A I would - I would estimate that 30 minutes passed, 30 to 40 minutes passed
1248 before I visually saw an active flame. Um, there was a lot of smoke out of the
1249 number four side of the building units. Uh, Sergeant (Garcia)'s team on the
1250 north side of the building uh, were reporting that there was no smoke at that
1251 side of the building, that they could see in the window and little to no smoke
1252 occurring on the north side master bedroom.
1253

1254 Q1 Okay. Eventually do you see flames in the front of uh, number four, I guess I
1255 should say?

1256
1257 A I did. I- I don't know if I was present when they first broke out um, I- I - there
1258 was a point when I recognized that um, this fire was going to increase - was
1259 increasing in volume and was consuming something and spreading inside the
1260 house. Um, the way we had fire trucks on standby and uh, I took it upon
1261 myself at that time to uh, make sure that the command van that was blocking
1262 [REDACTED] Road was removed to allow access to the fire trucks. Um,
1263 somewhere sometime I made a request for a second fire truck and by the time
1264 I had allowed them to enter on the [REDACTED] Roadway uh, I uh, that was
1265 ge- I was hearing on the radio that the fire uh, smoke - you could see it from
1266 400 yards away coming up over the hillside, was increasing in volume and
1267 somewhere during that time they advised that um, flames were engulfing the
1268 number four side.

1269
1270 Q1 Okay.

1271
1272 A And by the time I got down there good amount of fire was um, a flame was
1273 shooting out of the A and B windows and again Deputy (Freely) was
1274 desperate in his attempts to advise [REDACTED] that the structure was on fire as he
1275 had done so for the prior 40, 30, 40 minutes. And um, was desperate in his
1276 attempts to communicate for that [REDACTED] to surrender and remove himself
1277 from that building. Um, so it was sometime after that that I saw the flames.

1278
1279 Q1 Okay. Um, at that point, why didn't you have the firemen go clean up the
1280 place?

1281
1282 A While we were standing there, somewhere at that point I returned back I had
1283 uh, uh Chief (Sherman), who is the Chief of the fire department, stage his fire
1284 truck on the [REDACTED] Road and I ran back down to the building and um,
1285 the fact that we had an active shooter in that building that uh, that actively
1286 shot in the past, the fact that I knew that there were numerous firearms in that
1287 house, the fact that I knew that there was numerous - there was a large amount
1288 of ammunition in that building and the fact that there was firearms seen -
1289 reported seen at that A window of that structure, that it was unsafe for a fire
1290 personnel to go in and I told at one point (Dwayne Sherman) that he
1291 understood that when we have somebody in handcuffs or when the building
1292 collapses on itself or there were no longer sounds of fire - of ammunition
1293 burning off in there that I could allow him and his firemen to approach that
1294 building and he uh, he understood.

1295
1296 Q1 Okay.

1297
1298 A There was - prior to that, during that time um, I was standing again with the
1299 cable in front of that near the vehicles and we could hear numerous uh, what
1300 we thought at one time, was large caliber, it was a handgun that went off and

1301 the comment was possibly that if he committed suicide that he did at that time
1302 or he was firing out but it was a large um, uh, bang, it could have been an
1303 aerosol can but shortly after that you could hear other rounds um, being
1304 burned off and exploding inside the residence. Um, there was a report of a
1305 propane tank on a number three side of the building, adjacent to the building,
1306 close proximity in the wind at that time was blowing from the west to the east
1307 and blowing up the slope towards that reported propane tank. We were not
1308 able to clarify if it was a small five gallon tank or a large commercial sized
1309 residential, one of those 150 gallon tanks.
1310

1311 Q1 So at what point did you decide it was safe uh, for you to have the fire
1312 department come down and put out the fire?
1313

1314 A I continued communications with Sergeant (Garcia) on the number two side of
1315 the building and from our vantage point on the number four side, the building
1316 looked and appeared fully engulfed. I kept continuing, getting reports that the
1317 structure on the number two side, the one two corner was still intact, that the
1318 windows were getting smoked but uh, it was, the survivability in something
1319 on that side was probably good and the fact that this individual was not
20 making - taking the options to remove himself from the building that I just
1321 was - continued to hold the fire department. At some point um, when the
1322 ceiling uh, collapsed onto the three four corner of the building, it appeared
1323 that the building was fully engulfed and I don't know where I was, probably
1324 moving up to get a better look but uh, the order was to allow the fire trucks in
1325 and they were moving forward and Sergeant and Lieutenant No- (Moorey)
1326 um, was near the fire trucks at that point and I believe he is the one that gave
1327 the order for the fire trucks to move up. At that time they were already
1328 committed around, we had already made um, some plans and put those plans
1329 in action. We marked, we knew we had a crime scene here and that we had to
1330 um, mark the location of those Hoopa Valley tribal units that were in - that
1331 were in- impeding the way of the - the fire trucks and so we marked those
1332 areas, those vehicles were moved out of the way, two other patrol cars were
1333 moved out of the way that were backed around the corner and uh, when the
1334 roadway was made clear, shortly after that period, I believe Lieutenant
1335 (Moorey) um, sent the fire trucks in to what he believed was a fully engulfed
1336 um, structure.
1337

1338 Q1 Okay. And after the fire's uh, put out and contained, what do you learn after
1339 that?
1340

1341 A I learned that the fire department cut a hole into the bathroom on the number
1342 one side, there are two bedrooms I believe on that side of the structure. On
1343 the number one side of the building, they cut a hole mid trailer about five feet
1344 off the ground and they were able to peer into a three by three cut that they

- 1345 made and discovered a body inside the, on the floor of what appeared to be a
1346 bathroom of the structure.
1347
- 1348 Q1 And from - to your knowledge, George, that - that hole just happened to be cut
1349 there?
1350
- 1351 A Correct. I don't know who gave directions. At that point the fire department
1352 had already fi- been fighting that fire for I would say twen- 20 minutes,
1353 getting the fire under containment so they could move in with their cut saws,
1354 at that time it was just a hose operation and uh, trying to knock it down.
1355
- 1356 Q And as - and as far as being in charge um, out there of the - of your SWAT
1357 team, are you in charge of the tactical dispatchers also?
1358
- 1359 A I don't know if that was ever clearly defined in the past.
1360
- 1361 Q Is that more of a information process to you is what that is?
1362
- 1363 A That is correct. They're more of a scribe that uh, hopefully can uh, document
1364 all the ongoings and requests that I make during that time and anybody else
1365 makes an arrival and they keep track of arrival and demobilization of even a
1366 few units on scene.
1367
- 1368 Q1 Are your communications during a tactical operation recorded?
1369
- 1370 A No.
1371
- 1372 Q1 Audio recorded, I guess I should say. They are recorded by the tactical
1373 dispatch...
1374
- 1375 A Correct they are um, () from Eureka Police Department and a
1376 trained tactical dispatcher um, () was the other tactical
1377 dispatcher from the sheriff's office assigned and they in my experience in the
1378 past and this event duplicate as they here information to keep a better track of
1379 information so the both of them keep independent notes of chronicle -
1380 chronological events occurring.
1381
- 1382 Q1 Okay. And when you get out there, George, are you updating uh, anyone
1383 above you...
1384
- 1385 A I have.
1386
- 1387 Q On what those situations are?
1388
- 1389 A That's correct.

1390
1391 Q Okay and who would that be?
1392
1393 A I had numerous conversations with - Under Sheriff (Mike Downey) and
1394 Sheriff (Gary Foke).
1395
1396 Q1 And are - are you advising them of what you are going to do or are they
1397 making decisions along with you?
1398
1399 A No I provide them with the perimeters of what we're dealing with and the
1400 resistance that we have and the situation and uh, describe the environment as
1401 best as possible, describe to them both what has occurred, what is successful,
1402 not as successful and that my plans in the future.
1403
1404 Q1 Okay.
1405
1406 A None of them, neither the under sheriff nor the sheriff made any alterations
1407 um, uh, during my discussions with them to the plan that I had.
1408
1409 Q Okay and on these surrender orders, okay? And this is just kind of for
1410 information, on surrender orders, say a [REDACTED] eventually says, "Okay, I'm
1411 ready to talk."
1412
1413 A Mm-hm.
1414
1415 Q What do you guys do then even though the [REDACTED] has shot?
1416
1417 A We would have continued if he would have - it would have been very difficult
1418 and it was discussed to deliver a phone to that structure. However uh, we
1419 obviously roll with the operation, come up with uh, alternative plans. But the
1420 fact that he was an active shooter, we were not able to get any communication
1421 devices in him to set up communications with him. Had he started
1422 communicating, had he requested a device, a throw phone, a cell phone um, it
1423 would have been in the area the negotiator's commander to work out a
1424 delivery request for that, whether the [REDACTED] stand out on the front porch
1425 unarmed and we're able to deliver a phone in proximity and he - within ten
1426 feet - and he steps out and grabs it, whether uh, he goes to another side of the
1427 house and communicates with somebody on that side of the building while we
1428 agree to deliver a phone on the opposite side of the building, there are several
1429 options that we could exercise in the delivery of that phone to work it. The
1430 fact that he fired on us in the first three hours of being on scene we would
1431 have continued negotiations with him had he begun negotiations with us.
1432
1433 Q And um, you mentioned weapons. What information did you have of what
1434 type of weapons the [REDACTED] had?

- 1435
1436 A Information was coming back to me uh, from uh, Chief (Willy Hostler) and
1437 that he'd interviewed and several people had interviewed the resident who
1438 lived there, [REDACTED], who said that uh, A) he was seen with a rifled
1439 scope rifle, B) that there was a safe inside the residence that contained uh, an
1440 AK47, an AR15, a 45 caliber handgun and a shotgun with ammunition for all
1441 of those described weapons except for the AK47.
1442
- 1443 Q Okay. And as far as letting family members attempt to talk to somebody, is
1444 that the same reason you wouldn't even allow the mental health people to go
1445 and do that, because of the situation, the active shooter and how close they
1446 would be or is that something that is ever done?
1447
- 1448 A As the commander of the tactical division it w- we had no vantage point to get
1449 anybody into a safe manner as a civilian who we would ever allow anyone to
1450 put themselves in that position to communicate from that location with him.
1451 B) He was not communicating with us so had we even made contact with him
1452 to say, you know, is there anybody you want to talk to, we never got to that
1453 point with him because there was no dialogue from him and the negotiations
1454 commander would have to deal with the issue whether or not and its off
1455 protocol in the past, in my knowledge, in my experience of dealing with these
1456 situations, in allowing family members on the onset to talk to these
1457 individuals inside that - that are barricaded, that they not talk to them until we
1458 establish a profile on the [REDACTED] what it is it exactly that made him angry,
1459 who made him angry and by golly evaluating whether the people who are
1460 going to talk to him are parties that caused him to become angry in the first
1461 place, that is very common discussion we have when allowing people outside
1462 of the professional negotiators to talk to anyone barricaded in the residence.
1463 And we never got to any of those levels because we had no dialogue here and
1464 we'd also learned, and I'd also shared with other folks and it was gathered also
1465 that the mother um, um, may have very been responsible or a party to the
1466 point that caused this [REDACTED] to become angry or was uh, somehow in a
1467 position in his life that it wasn't very favorable to him and we were aware of
1468 that information, that information was shared uh, uh, to me by the father and
1469 then of course, negotiators gathered that information on their own behalf.
1470
- 1471 Q Okay. And has um, chemical gasses put in four, three, and two, how about
1472 one?
1473
- 1474 A That area out there was a wide open area. Uh, I believe on that side th- the
1475 range on that side was over 100 yards if we tried to introduce anything.
1476
- 1477 Q And the only safe spot would have been back by the Yurok, is that correct?
1478

1479 A That was cover. There was cover available, berry bushes, and there was cover
1480 available um, or conceivably available and you could hide behind a bush but
1481 you weren't getting good cover where bullets would stop it and to put our
1482 units in a position where they would uh, have to expose themselves to uh, to
1483 load and to fire uh, a weapon into that house, the closest range they could get
1484 on the number one side I believe was just too extreme.
1485

1486 Q Okay. And as far as your gas, do you guys keep an inventory of um, of the
1487 gas you guys have?
1488

1489 A There is an inventory in the trailer.
1490

1491 Q Okay. We've already spoke to (Quenelle) about that so if you can
1492 (unintelligible) make sure you get that to us.
1493

1494 A Mm-hm.
1495

1496 Q Um, a- and (Joseph) mentioned that you have background chemical agents,
1497 what's that?
1498

1499 A I don't - I was not a grenadier, I was an operator. The entire time that I was
1500 on the team technically I'm off of the team because I am not a tactical operator
1501 of the team anymore. I just truly arrived to command the um, I don't think in
1502 my 25 years um, or 20 years that other than in training that I deployed a
1503 chemical agent other than distraction devices and therefore it is truly the
1504 experience and expertise of our grenadiers and our teams when given a task
1505 that they given a request and that they with their base knowledge and
1506 equipment either uh are able to fulfill that request or not. Truly the team
1507 leaders run the operations um, onsite when given a task to introduce chemical
1508 agents on this situation. I believe there was discussions that the easiest ones
1509 were A and B, therefore, the direction came from me to introduce chemical
1510 agents, however, often in - in many situations that I've been involved in, the
1511 team commander gives an assignment but doesn't give specifics of how it's
1512 carried out. I originally told her to come up with a port plan because their
1513 onsite they have to come up with a plan to approach and to break out windows
1514 and insert cameras. Um, they have to come up with a plan of or provide
1515 information where chemical agents could be introduced and I believe that uh,
1516 the amount, the volume of chemical agents that went into this uh, would drive
1517 a normal person out of it and therefore porting was an option, dynamic entry
1518 was an option but I ruled out and therefore I was working on a mechanical
1519 destruction to pull the walls out from underneath him and aside from him and
1520 to be able to port this from a distance.
1521

1522 Q1 And speaking of that, y- you mentioned you had met with Deputy (Barney)
1523 about the saturation level...

1524
1525 A He advised me that uh, in a contained space uh, you can starve the oxygen
1526 level, starve the amount of oxygen needed to survive um, Deputy (Barney)
1527 advised me that with the windows and the ventilation and the cross wind in
1528 that building that um, it - it would not - it would not be possible to take this to
1529 complete saturation and then starve the oxygen out of this. It would be very
1530 uncomfortable for a long period of time, however, he could, you know, find a
1531 place to hide, wet towels, bury his head in some blankets, things of that nature
1532 and the information we were getting was in fact that that's what he was doing,
1533 covering himself with blankets and so forth.
1534
1535 Q And have you - George, have you seen that happen before where gas is
1536 introduced into a residence uh, whatever it may be and people don't come
1537 out?
1538
1539 A Correct.
1540
1541 Q1 And another thing about with the gas um, some what difficult because having
1542 the act - the [REDACTED] shooting at you - at your teams, the shots had to be taken
1543 from so far away it was difficult to get the full amount of rounds you would
1544 have liked to get in there?
1545
1546 A Correct. EPD I believe had a less than 50 percent success rate on their
1547 number two side as far as...
1548
1549 Q And number three you weren't sure?
1550
1551 A I'm not sure what the success rate was or whatever the count was carried out.
1552
1553 Q1 And as far as you had heard from your team, it was good?
1554
1555 A On the number four side delivery from our team that the success rate was
1556 good.
1557
1558 Q1 Okay. George, when you were out there did you hear anything about a fire
1559 being started inside of the residence or anything like that?
1560
1561 A Uh, no. I did not.
1562
1563 Q1 Okay.
1564
1565 Q And um...
1566
1567 A I don't have any recall of anybody reporting a fire inside.
1568

1569 Q1 And you had made it clear that pyrotechnics were not going to be used on that
1570 house, at least at that time?

1571
1572 A Exactly, exactly. I wanted a uh, an inventory if we had them and it was
1573 looking like we didn't have any for a period of time until the CVC provided
1574 and showed me that they did in fact have some but it was not in fact our intent
1575 to introduce pyrotechnics at that time.

1576
1577 Q1 And going back to the - the - the a- chemical agents you guys got from CVC,
1578 you are not a hundred percent sure of what - what they provided to your guys?

1579
1580 A Uh, I'm not. I cannot speak to what was delivered in the vest.

1581
1582 Q And um, as far as the sting ball, you have no idea if that was deployed or not
1583 deployed?

1584
1585 A No direction was given to the deploy of the sting ball. I do not have any
1586 knowledge nor do I have any recollection of a sting ball being discussed. The
1587 two balls that are uh, that would be in the realm of a sting ball were shown to
1588 me and those were the two speed heats that were uh, described to me as
1589 something they would use in a yard, however, you know, in a situation like
1590 this it's - it's a leap of force and we were faced with that.

1591
1592 Q So uh, according to you from what you know, is a sting ball a pyrotechnic?

1593
1594 A I don't - I don't know the dynamics of a sting ball.

1595
1596 Q You saw two balls that looked like...

1597
1598 A I saw two that were flame- that were uh, pyrotechnics.

1599
1600 Q Okay.

1601
1602 A And we made a decision - Sergeant (Nova), myself and the commander with
1603 CVC that now was not the time to use - we have them but we...

1604
1605 Q1 But those two pyrotechnics that were in the shape of a ball were actually
1606 brought back.

1607
1608 A That's what I was told. Correct.

1609
1610 Q1 George, in your opinion do you got any idea how that fire got started?

1611
1612 A I have no idea.

1613

1614 Q1 And besides your plan to pretty much demolish the house the next day...
1615
1616 A Mm-hm.
1617
1618 Q1 Is it - in your own opinion is there anything else you think you guys could
1619 have done to resolve the matter?
1620
1621 A The only thing we could have done was to set up and establish
1622 communications with him and been successful in our negotiations and got a
1623 peaceful resolution whether he surrendered and came out of the house is a
1624 viable um, resolution of this, however, um, we never approached that and I
1625 was not in a position at that time to send a team in and um, enter that building
1626 knowing that we had an individual that's already fired at us and therefore I
1627 was looking to advance um, advanced methods of porting that and that truly
1628 would have been just demolishing that building and it would either force him
1629 to um, surrender or engage with us, much like with the chemical agents he
1630 could have surrendered or continued engaging with us with his firearm and of
1631 course we had the counter snipers positioned to uh, to deal with that threat.
1632
1633 Q1 Wh- what was your uh...
1634
1635 A Rules of engagement?
1636
1637 Q1 Rules of engagement, thanks.
1638
1639 A My rules of engagement was to react to threat one point during the night prior
1640 to darkness there was a request to uh, change our rules of engagement to uh,
1641 move inside the house but I was not - I could not guarantee the fact that the
1642 [REDACTED] was the only party inside the residence at that time. We had a witness
1643 that had been seen, a witness that had disappeared and it was unknown if he
1644 got back in the house. We later located that person that was [REDACTED]
1645 hours later and discovered with contact with him discovered that he had not
1646 gone in there but the fact that the rules of engagement was still to react to
1647 threat.
1648
1649 Q Okay a- and you're in charge of CIT here at the sheriff's office.
1650
1651 A That's correct.
1652
1653 Q And what is your role in the Critical Incident Response Team then?
1654
1655 A I c- command members who are assigned to Critical Incident Team.
1656

1657 Q2 Okay. Lieutenant, been talking here for a while, if you will refer to this
1658 dispatch log here in front of you, is this form actually that your tactical
1659 dispatcher made?
1660
1661 A There is no name who uh, produced this. I'm assuming that um, ([REDACTED]
1662 [REDACTED]), our tactical dispatcher, um, completed this typed version of her
1663 handwritten log. But it is not know- it is not listed or labeled in any way other
1664 than SET operation June 3, 2007 1400 hours, location Bloody Camp Road
1665 near Bald Hill in Pine Creek, type of incident barricaded [REDACTED] but it is not
1666 labeled as the producer.
1667
1668 Q2 So it's not necessarily who produced it but that seems to be the accurate log of
1669 visits from that day.
1670
1671 A They appear to be.
1672
1673 Q Um, do you refer a lot the command van?
1674
1675 A Mm-hm.
1676
1677 Q2 What's the purpose of the command van? Who's in it and is this pretty much
1678 where you're at before the duration of this incident or most of that duration?
1679
1680 A Um, yes, mobile command center is uh, a physical vehicle that uh, I think is
1681 28 feet long and uh, it's a uh, employee situations that uh, require an incident
1682 command as opposed to some places downtown a- and you can utilize a motel
1683 room, an office space, however, in an open area like that the command van is
1684 basically a portable office where the incident commander and can take
1685 information and disseminate orders and uh, provide information to upper
1686 command staff, the sheriff and under sheriff.
1687
1688 Q2 Do you know who called [REDACTED]
1689
1690 A Um, I believe it was Lieutenant (Knight).
1691
1692 Q2 And you referred to two employees from [REDACTED] who showed up um,
1693 did you speak with him specifically?
1694
1695 A I did, briefly.
1696
1697 Q2 And how long about were they actually there at the scene?
1698
1699 A Without looking at the notes, they were there, you know, it was dark, I'd say
1700 1100 pm until about 200 am, three hours originally. They did return in the
1701 morning on Monday.

1702
1703 Q2 So there for a few hours and maybe actually came back.
1704
1705 A Mm-hm. Mm-hm.
1706
1707 Q2 Did they give you any specific advice about what you could or couldn't do?
1708
1709 A No. No.
1710
1711 Q2 No options at all?
1712
1713 A No. They - they did not uh, provide me with any information that would have
1714 assisted me in m- my tactics, in my plans of getting him to - to exit the
1715 building.
1716
1717 Q2 Come out while your in this command van, the command post, you're
1718 constantly staying in contact, you mentioned with the sheriff and under
1719 sheriff.
1720
1721 A No not constantly. As events move along um, details that they're not aware
1722 of, once in a while we keep them updated. I, they were notified of the
1723 situation uh, but, you know, by at least midnight that night uh, that we'd been
1724 shot at, units had been shot at on two different occasions and we agreed we'd
1725 tread fire and that we'd request that a critical incident response team and four
1726 of our deputies had been shot. They were aware of that. They were aware of
1727 the physical environment that we were at. They were aware that the
1728 individual was barricaded and armed and refusing to negotiating and uh, they
1729 were aware of plans for CVC to respond. I notified them that we had to stall
1730 out due to helicopter issues um, and they were aware of the plan to introduce
1731 gas in the event to drive him into a surrender.
1732
1733 Q2 But were they involved in any serious decisions as they go or...
1734
1735 A I- I- I can't speak for that, however, if they heard something that they want to
1736 alter change or manipulate then they provide that instruction to me.
1737
1738 Q2 Were any other options discussed other than using gas, the initial phase of this
1739 incident.
1740
1741 A Options other than gas um, well we could have continued waiting um, but uh,
1742 [REDACTED], that was one of the, the only thing [REDACTED] did provide me was
1743 that, you know, waiting any longer would be - wouldn't help anything.
1744 They're aware with this individual I think it was a very short and do I have
1745 any benefit of waiting any longer and their response to me, I believe it was
1746 [REDACTED] from the crisis unit goes no, you're either going to drive him into uh,

1747 engaging with you or you're going to drive him into surrendering and that's
1748 your options. And that's - that's - that's the avenue that we took.

1749
1750 Q2 You talked about uh, your team making a couple deployments of gas up to the
1751 number four side of the structure with handheld gas, was there ever any
1752 discussion of maybe throwing one of the throw phones in at that point in time?
1753

1754 A No. No.
1755

1756 Q2 Would that be something that would be considered and if not, why?
1757

1758 A We'd already contaminated that house to a point where his negotiations were -
1759 he would not be able to withstand the agents that were in there. He was
1760 hunkered down and couldn't get out.
1761

1762 Q2 So you also mentioned other than the gas you're aware of any other items
1763 being thrown in the house.
1764

1765 A No. From our units? From law enforcement...
1766

1767 Q2 Any law enforcement units, yes.
1768

1769 A Well other than the chemical agents requested um, there was no other um,
1770 items ordered to be thrown in there. The items were planned to be thrown in
1771 there obviously from what I understand now many of those devices and
1772 projectiles and barricaded 37 millimeters didn't even make it into the structure
1773 so um, so the fact that it was requested to be deployed and fired uh, the
1774 success rate was not 100%.
1775

1776 Q2 Um, throughout this whole process at some point in time obviously it became
1777 an act active shooter situation but at any point in time if [REDACTED] would
1778 have made a contact with you obviously that would have changed the scenario
1779 but would his family be allowed to be involved in that process, even if he did
1780 make contact and why?
1781

1782 A That'd be a long drawn out process that the negotiator commanders and the
1783 negotiating team would have to respond to. Um, truly on the onset, no they
1784 would not because of the tactical difficulties of making it safe for them it was
1785 not uh, after a long period of time, who knows what the negotiators would
1786 have allowed. Um, however it was no communication was ever established to
1787 create that and nor was there enough information gathered for them to set a
1788 profile or figure out what was really upsetting [REDACTED]
1789

1790 Q Anything else?
1791

1792 Q1 As far as uh, the canisters that were thrown in, there is - have you ever heard
1793 uh, pyrotechnic canisters continuous burn but are the actual fire is contained
1794 within the canister?
1795
1796 A I'm not familiar with it, no.
1797
1798 Q1 And (unintelligible) that uh, throw phone and just in your opinion you guys
1799 had attempted to negotiate I have no idea how many hours but a lot of hours a-
1800 and throwing that throw phone in there um, in your own opinion, do you think
1801 he would have answered that thing anyway?
1802
1803 A No I don't believe he would. He could see our units face to face. He could
1804 see our negotiators face to face and if he wanted to talk he would have talked
1805 to that level, throwing a phone in there I don't think would have changed him
1806 at all.
1807
1808 Q1 Okay, can you sign this little beautiful sketch we did here? And uh, George,
1809 uh, is there anything that you can think of that we haven't asked you that
1810 would be important for us to know?
1811
1812 A No, other than your investigation into what was in that vest when it came
1813 back.
1814
1815 Q W- what now?
1816
1817 A Th- the vest that contains the two additional canisters that were taken from
1818 CVC.
1819
1820 Q Okay. All right. I have nothing. End the interview at 1319 hours.
1821
1822
1823 This transcript has been reviewed with the audio recording submitted and it is an accurate
1824 transcription.
1825 Signed _____

1
2
3
4
5
6
7
8
9
10
11
12
13
14
15
16
17
18
19
20
21
22
23
24
25
26
27
28
29
30
31
32
33
34
35
36
37
38
39
40
41
42
43
44
45

INTERVIEW WITH BRIAN QUENELL

Q=Det. Rich Schlesiger

Q1=Inv. Steve Dunn

Q2=[REDACTED]

A=Brian Quenell

Q: Okay, the date is June 6, 2007. The time is 13...

A: June 7 isn't it.

Q: What did I say?

Q1: Sixth.

Q: Seven. 1304 hours. Case 200703162. Uh, we're at the Sheriff's Department, uh, in the meeting room of the Sheriff. Uh, present is Detective Schlesiger, Investigator Dun, Sergeant Quenell and his representation, [REDACTED] Brian, middle name J, right?

A: Correct.

Q: Quenell?

A: Q-U-E-N-E-L-L.

Q: 0817?

A: Correct.

Q: Um, Brian, how long have you been employed by the, uh, Sheriff's Office?

A: Thirteen years.

Q: How long as, uh, Deputy Sheriff?

A: Eleven.

Q: And you're currently a sergeant?

46
47 A: Correct.
48
49 Q: Okay. And you are a member of the -- our version of SWAT Team, the
50 Special Enforcement Team?
51
52 A: Yes.
53
54 Q: Okay. Uh, what is your position as a- on the SET Team?
55
56 A: Team leader.
57
58 Q: Okay. Do you have any other specialty position?
59
60 A: As far as what?
61
62 Q: Like gas man, sniper, anything like that?
63
64 A: No.
65
66 Q: Okay. Um, Brian, um, we're part of the Critical Incident Response Team,
67 which I'm sure you're familiar with?
68
69 A: Yes.
70
71 Q: Um, and we've been assigned to investigate the officer involved shooting and
72 other related things that occurred on the 3rd and 4th of June. The one thing I
73 got here for you is a, uh, little sketch that we drew, um, just so you can mark
74 down your guys, you, and things like that, so we can refer and get a little bit
75 sense- better sense of where everybody was at. Um, and on the 3rd, well first
76 of all, [REDACTED] you used to work (unintelligible) didn't' you?
77
78 A: Yes.
79
80 Q: Did you ever deal with, uh, [REDACTED] before?
81
82 A: No.
83
84 Q: And how did you become notified that there was a situation on Bloody Camp
85 Road in Hoopa?
86
87 A: Dispatch called me at home, and, uh, told me that, the SET Team was being
88 paged out.
89
90 Q: Okay, do you recall what time that was about?

91
92 A: Uh, sometime after 4 o'clock, around in there.
93
94 Q: Okay. Um, and at the time, did you direct them, uh, to tell the other members
95 anything?
96
97 A: No, I was advised already that, uh, we were to meet at the office in our
98 camouflage uniforms and that Lieutenant (Caventa) was aware of it.
99
100 Q: Okay. And so you responded?
101
102 A: Yes I did.
103
104 Q: And who did you meet with? I mean, you- you're responding with all your
105 team members?
106
107 A: Correct.
108
109 Q: Probably easier than going through all your team members, um, who wasn't
110 there?
111
112 A: Sergeant (Garcia), Deputy (Bishop), and Deputy (Masaro).
113
114 Q: Later on, did those three team members arrive on scene when you were up
115 there?
116
117 A: Yes they did.
118
119 Q: Okay, so you had full- full team?
120
121 A: Yes I did.
122
123 Q: Um, and did you brief at that time?
124
125 A: Yes.
126
127 Q: What- what was the briefing consist of?
128
129 A: Basically the originally call, which was a welfare check. Uh, had information
130 that, uh, [REDACTED] was inside the residence brandishing handguns at the
131 officers currently on scene.
132
133 Q: Okay.
134
135 A: And...

136
137 Q: Your guys's structure of the SET Team, can you run through that real quick
138 from top to bottom?
139
140 A: Lieutenant (Caventa) is the team commander, myself and Sergeant (Garcia)
141 are the team leaders, and, uh, then we designate assistant team leaders,
142 typically try to use, uh, guys with the most amount of time on the team, uh,
143 and usually training officers. Uh, on this mission, uh, Deputy (Jesse Taylor)
144 was my assistant team leader.
145
146 Q: And that's just for your team or was there a- another team...
147
148 A: There was -- yeah Sergeant (Garcia) was in charge of, uh, his own element,
149 uh, and I believe he had Sergeant (Miller) as his assistant team leader.
150
151 Q: Okay. And from here you guys responded up to Bloody Camp road. Is that
152 correct?
153
154 A: Yes.
155
156 Q: Who did your ride with?
157
158 A: (Jesse Taylor).
159
160 Q: Okay, and was that a patrol vehicle or?
161
162 A: Yes.
163
164 Q: Okay, and I believe, it was probably around 1830 hours that you guys arrived
165 on scene?
166
167 A: 1823.
168
169 Q: Okay. And, um, when you arrived on scene, um, what did you observe or
170 what had occurred?
171
172 A: Uh, when we arrived on scene, we pulled down a gravel driveway. There
173 were numerous patrol cars all in line. Almost immediately after I got out of
174 the passenger seat, I heard gunshots, uh, coming from the area of the
175 residence. I responded to the trunk of my patrol vehicle, retrieved my rifle,
176 notified dispatch that shots had- had been fired and requested that Deputy
(77) (Fulton) expedite his response because he had all of our equipment in the, uh,
) 178 SET trailer.
179

180 Q: Uh, when you said you exited your vehicle and heard shots, how many did
181 you hear?
182
183 A: Three.
184
185 Q: Okay. And, um, how far was Deputy (Fulton) behind you?
186
187 A: He arrived within minutes after that.
188
189 Q: Okay. And did you respond, uh, up further before getting your SET gear or
190 did you get your SET gear first?
191
192 A: Got my SET gear first.
193
194 Q: Okay. And when you arrived on scene, um, were you in charge?
195
196 A: Yes I was.
197
198 Q: Okay. And, um, after getting your SET gear, what- what happened after that?
199
200 A: I started breaking our team up into two elements, a- actually three elements to
201 relieve the officers who were on scene and to provide some containment for
202 the residence.
203
204 Q: When you say element, would you call that three separate teams?
205
206 A: Yes.
207
208 Q: Okay. Uh, do you recall who was in which team?
209
210 A: Uh, in my team, it was myself, Deputy (Jesse Taylor), uh, (Tony Gomes),
211 (Jamie Barney), (Blake Masaro). Yeah.
212
213 Q: Okay. And, uh...
214
215 A: Sergeant (Garcia) was in charge of Deputy- or Sergeant (Miller), Deputy
216 (Lundy), Deputy (Fulton) -- I can't remember. And I sent out a counter-sniper
217 element that consisted of Deputy (Bishop) and Deputy (Ireland).
218
219 Q: Okay. The- the guys that were initially missing, do you know what time- not
220 what time, how much longer did they- until they got there and you sent- sent
221 them out?
222
223 A: Um, (Garcia) phoned me right after I had put out over our main frequency that
224 shots had been fired, I think he was at Blue Lake and he was now responding

225 Code 3, so he arrived a short- short time after that. And then, um, Deputy
226 (Masaro) arrived a short time after the second shooting incident.

227
228 Q: Okay. And, um, what did you direct or do, um, as far as positioning people? I
229 mean, did you- were you aware there were people out around the house area?

230
231 A: We- we had an idea that, um, I had spoken with Lieutenant (Caventa) and he
232 advised me that there were several, uh, Hoopa Tribal officers, some deputies,
233 and Yurok public safety officers who had set up a perimeter around the
234 residence. Uh, my goal was to relieve those guys and get our team in place to
235 to provide a perimeter.

236
237 Q: Okay. And where- going with your team first, where- where did you direct
238 your team to go to.

239
240 A: We moved up to this first vehicle.

241
242 Q: Okay. Will you put the initials of you your- you and your team there? Okay,
243 and where did the other team go?

244
245 A: (Randy)'s team moved back over to this vehicle. I don't know their exact
246 positioning. They were in a position where they could observe the 1, 2 side of
247 the residence. So I would have to believe they were back over here
248 somewhere.

249
250 Q: Okay. What about- was there a deputy and a Yurok officer that was
251 somewhat- and a civilian that was somewhat trapped behind this Yurok PD
252 car?

253
254 A: Yes there was.

255
256 Q: How did they get out of there?

257
258 A: I sent (randy)'s team, Sergeant (Garcia)'s team down. They- they cut through,
259 uh, the neighboring property, um, went through several different fences, came
260 up from behind, and, uh, relieved them. And I don't know how they exited.

261
262 Q: Okay. When you guys initially -- first of all, is this right how the house is?

263
264 A: It was tanted a little bit. It wasn't straight on. More turned like that.

265
266 Q: So, the 4 side was facing more towards the Hoopa vehicle?

267
268 A: Correct.
269

270 Q: And when you guys arrive down there, do you observe anything at the house,
271 uh, hear anything?
272
273 A: Um, you could- I could periodically hear movement from inside. I notice that
274 both of these, uh, patrol cars- Hoopa vehicles had what appeared to be bullet
275 holes in the windshield.
276
277 Q: And how far are you guys would you estimate from that vehicle, the patrol
278 unit from the house that you could see?
279
280 A: Sixty, sixty-five yards.
281
282 Q: Okay. And as far as the A and B windows on the 4 side, how much could you
283 see?
284
285 A: You could see- I could see the entire 4 side, and probably a quarter of the way
286 down the 3 side.
287
288 Q: Okay. At any time, did negotiators arrive?
289
290 A: Yes.
291
292 Q: Do you know when about that was?
293
294 A: I do not know. Well, Sergeant (Fridley) was on scene when I arrived and he
295 was one of our, uh, lead negotiators. And, uh, Deputy (Daniels) responded up
296 with us, as well, so uh, Deputy (Daniels) arrived on scene the same time the
297 rest of the team did.
298
299 Q: Okay. And, uh, did- was- was there ever any yelling from the house or
300 anything like that that you could hear?
301
302 A: I couldn't hear any, no.
303
304 Q: Okay. And, um, you guys maintained a position there and when negotiations
305 started, how long did that go on for?
306
307 A: Well, negotiations -- Sergeant (Fridley) and Deputy (Daniels) started
308 negotiations from the second Hoopa vehicle using the PA system, um, at
309 about 1905 hours. They began negotiations over the PA.
310
311 Q: Was that pretty much continuous?
312
313 A: Yeah.
314

315 Q: Okay. Well, did it continue until nighttime?
316
317 A: Yes.
318
319 Q: Okay. And was there any responses from them? Or not from them, from the
320 house?
321
322 A: I couldn't hear anything. We were getting reports from, uh, Sergeant
323 (Garcia)'s team, and, uh, Deputy (Ireland) and Deputy (Bishop) who ran a
324 counter-sniper position on the number 3 side that they could hear yelling from
325 inside the residence. But I- I, myself, never heard anything.
326
327 Q: Okay. And we got no windows on this side. Do you recall if there were
328 windows on the 3 side?
329
330 A: Yeah, there was a window here. There was a door here, and I think there's an
331 additional window here.
332
333 Q: Okay.
334
335 A: And this side has a window right here.
336
337 Q: Okay. The number 2 side?
338
339 A: Yes.
340
341 Q: Okay. And, um, eventually, Lieutenant (Caventa) arrives on scene, is that
342 correct?
343
344 A: Correct. He was on scene when I arrived on scene.
345
346 Q: Okay. So, explain to me what his responsibilities are compared to your
347 responsibilities.
348
349 A: He's in charge of formulating the plans, how we're gonna deal with this. My
350 responsibilities are to ensure that whatever his plans are, that my team
351 executes them.
352
353 Q: Okay, what he is, he- he's the planner and you're kind of the eyes for him as
354 far as the operation?
355
356 A: Correct.
357
358 Q: Okay. Um, as the evening goes on, what happens next?
359

- 360 A: At about 2058 hours, um, my team and I are observing the number 4 side, uh,
361 and get a report via radio from Deputy (Ireland) that he can see the [REDACTED] in
362 the number 4A window. Um, the [REDACTED] armed with a rifle.
363
- 364 Q: Where's Deputy (Ireland) at?
365
- 366 A: Deputy (Ireland)'s up in the brush.
367
- 368 Q: Would you put him up there for me, Brain? Is (Bishop) with him?
369
- 370 A: Correct.
371
- 372 Q: Are they both snipers or?
373
- 374 A: Yes they are.
375
- 376 Q: Okay. And as far as -- and (Randy)'s team is over by the Yurok PD car,
377 right?
378
- 379 A: Correct.
380
- 381 Q: Okay. Will you put those guys in there for me, too? Okay. So go ahead back
382 to 2058.
383
- 384 A: Uh, Deputy (Ireland) said he can see the subject in the number 4A window
385 and said he's armed with a rifle. Uh, at that point, uh, Deputy (Barney) is
386 behind the open driver's side door of the front Tribal, uh, vehicle. I take a
387 pos- position behind him. I could now see the window. I see what looks like
388 a barrel pointing the window with a white rag tied to the end of the barrel.
389 Um, trying to get more information from (Ireland), and about that that time. , I
390 hear a gunshot. Sounds like it ricocheted off the front of the vehicle we were
391 at. I briefly ducked down, maybe a second or two, popped up, look at the
392 window again, could see the gun barrel. And, uh, the subject's arms, I fired
393 one round. Continued. The subject was still standing there. I fired an
394 additional round, and then, uh, shortly thereafter, I heard a loud thud inside
395 the residence. And then there were reports from, uh, Sergeant (Garcia)'s team
396 that the subject was in the back part of the house screaming and yelling and he
397 had turned off some lights.
398
- 399 Q: Okay. Brian, when you, uh, were standing there, you were in your full SWAT
400 uniform?
401
- 402 A: Correct.
403
- 404 Q: Okay. How- prior to the shot that he fires -- he fires one shot?

405
406 A: Yes.
407
408 Q: You believe it hits off the front of the vehicle?
409
410 A: I believe it hit the vehicle. I don't know exactly where.
411
412 Q: Okay. Um, and everyone else is in full SWAT gear there that's down there by
413 that vehicle?
414
415 A: Yes.
416
417 Q: And are those- those vehicles are fully marked?
418
419 A: Yes.
420
421 Q: Okay. Um, you- you say you- you see a rifle with a white flag on it. Okay.
422 And is it pointing towards you guys at that time?
423
424 A: Yes it was.
425
426 Q: Okay. At first, what did you think when you saw -- we all know the standard
427 white flag thing of giving up. Did you think that at- at first?
428
429 A: I didn't know what it was. It almost looked like a sock tied to the end of the
430 barrel. I didn't know if it was- without Deputy (Ireland) telling me it was a
431 rifle, I couldn't even tell, um, until, you know, it was completely out. When I
432 first saw it, it kind of looked like a metal rod with a white cloth hanging off
433 the end of it. I wasn't sure what it was.
434
435 Q: And at 9- 9:00 pm up there in Hoopa, it's starting to get dark by then?
436
437 A: Yes.
438
439 Q: Um, so you see something pointing towards you but the snipers that have
440 scopes can tell you that it was a rifle?
441
442 A: Correct.
443
444 Q: Okay. So one shot is fired and at that time, are- do you have your- are you
445 armed with your rifle?
446
447 A: Yes I am.
448
449 Q: Do you have your handgun and magazines with you?

450
451 A: Yes.
452
453 Q: But you're just armed with your rifle at that time?
454
455 A: Right.
456
457 Q: Do you have your rifle already pointing in that direction?
458
459 A: No.
460
461 Q: Okay. So the shot fires, possibly hitting the vehicle, and you duck down
462 momentarily and get back up. And then what do you see?
463
464 A: I- I could see the rifle still sticking out of the window pointing towards me. It
465 looks like I could see the subject's arms on the rifle.
466
467 Q: And then that rifle's being pointed still in you guys's direction?
468
469 A: Yes it was.
470
471 Q: Okay. And then you do what?
472
473 A: I fired one round.
474
475 Q: And did you- what type of site picture did you have?
476
477 A: I could see the rifle, uh, I couldn't see his torso or his head because of the
478 shadows. It was kind of back inside the residence a little bit. So I just a
479 moved up a little bit and put the top of my site where I could see his arm.
480
481 Q: Okay. And you fired one round at that time?
482
483 A: Yes.
484
485 Q: And then, um, what happened after that?
486
487 A: Uh, I continued to go through my optics and could see the [REDACTED] was still
488 standing there, I fired an additional round.
489
490 Q: What was the distance between those two rounds, their time between those
491 two rounds being fired?
492
493 A: Half a second to a second.
494

- 495 Q: Okay. And after you fired the second round, did you notice anything then?
496
497 A: That's when I heard the thud from inside the residence, and then we got
498 reports of the [REDACTED] being on the back side screaming and yelling.
499
500 Q: Well, when you were down there and fired your rounds, Brian, did anybody
501 else fire any rounds?
502
503 A: I- I didn't know at the time, but I found out later, yes.
504
505 Q: And who was that?
506
507 A: Uh, (Jamie Barney) and (Tony Gomes).
508
509 Q: Okay. Did you guys ever mention how many rounds you'd fired all together?
510
511 A: I believe we al fired two rounds a piece.
512
513 Q: Okay. After that had occurred, and- was there -- and the movement inside,
514 what went on inside after that?
515
516 A: I- I don't know.
517
518 Q: Okay.
519
520 A: We were in the process of getting the night vision goggles down to all of the
521 team so we can maintain, uh, surveillance, uh, on the perimeter make sure he
522 didn't come out without us knowing about it. Uh, we reported back to
523 (Caventa) that shots had been fired. Notified him of who was involved in the
524 shooting. And then, just the team just kept surveillance on the- on the house
525 the rest of the night.
526
527 Q: During that time, did attempts to -- let's back up here a sec. Negotiations and,
528 um, surrender orders are two different things, is that correct?
529
530 A: Correct.
531
532 Q: And, what mode were you guys in the whole time?
533
534 A: Negotiations. We were trying to get him to talk to us, try to get a peaceful
535 resolution to it, at least try to start a dialogue to find out what was going on
536 with him, and- and try to resolve the issue that way.
537
538 Q: After the shootings though, did you, uh, did guys issue surrender orders also?
539

540 A: Yes.

541
542 Q: Okay, so it was a mixture of both. Trying to get him to still talk to you guys,
543 but also try to, hey, give up, that type of thing?

544
545 A: Yes.

546
547 Q: Okay. And so you guys- while you guys are maintaining down here, um, um,
548 what goes on around the house?

549
550 A: Uh, due to the darkness, (Ireland), (Bishop) no longer had a good visual, so
551 they needed, uh, moving a little bit closer. Uh, we got reports that there were-
552 they could see the subject inside lighting a fire, uh, during the night. Um, then
553 occasionally, somebody would report that they could hear yelling or
554 screaming from inside. And somebody reported at one point that they saw
555 him folding clothes back out of this window, the number 2 window.

556
557 Q: Okay. Was there ever any mention about a fire or anything like that?

558
559 A: Yes. I believe Deputy (Bishop) said he could see him making a fire. Uh,
560 through our night vision goggles, we could see, uh, light coming from inside
561 the residence. Um, the B window, there appeared to be a television in there
562 that was on, but from the A room, which was normally dark throughout the
563 entire time we were there, occasionally we would see a- a flash of light, kind
564 of flickering that would be reminiscent of like a candle or a lighter being lit or
565 something like that.

566
567 Q: Okay. And going back to the window, Brian, was it so dark that you couldn't,
568 uh, describe what the person was, uh, wearing or anything like that?

569 A: Correct.

570
571
572 Q: Okay. And so then negotiations continue still up to the point of darkness.
573 Right?

574
575 A: Correct.

576
577 Q: And then, after that, you hear what you just told us, what goes on after that?

578
579 A: I have back and forth meeting with Lieutenant (Caventa). Uh, I told him
580 that, uh, negotiations should end because if he were to come outside, we
581 couldn't see him. And so at that point, it was decided we were just gonna lock
582 it down until daylight, and then we're going to move forward with continued
583 negotiations and- and, uh, come up with our plan after that. Lieutenant
584 (Caventa) said he was in contact with Eureka Police Department SWAT

585 Team, uh, leader, (Nova), and that their team would be up around 2 o'clock in
586 the morning so we could get a break and get some rest and eat. And they
587 would relieve us and we would be back in the morning and take over.
588

589 Q: So, what time do they come and relieve you about?

590
591 A: At, uh, 0313, I moved, uh, EPD's team up to my position and relieved all of
592 my guys.
593

594 Q: Okay.

595
596 A: I requested Sergeant (Garcia) meet back at the Command Post to take his- the
597 second EPD team to his location. And then I had Sergeant (Miller), uh, take
598 their sniper element to relieve Deputy (Ireland) and Deputy (Bishop).
599

600 Q: Okay. And, um, eventually you guys decide, um, to go to the sub-station to
601 either eat, maybe try to get a little bit of sleep, is that true?
602

603 A: Correct.

604 J4
605 Q: And at that time, do you cons- while you guys went to the sub, do you guys
606 consider you guys still operational at that time?
607

608 A: Yes.

609 Q: And that's because any time- you're only like 10 minutes away?

610
611
612 A: Yeah.

613
614 Q: If something did occur, you- you could respond right back. Did you get any
615 sleep?
616

617 A: No.

618
619 Q: And what- that was around 4:30?
620

621 A: Correct.

622
623 Q: And you guys were supposed to be back at 6:00?
624

625 A: 6:30.

626
627 Q: 6:30. Do you guys make it back about 6:30?
628

629 A: While we were at the sub, Sergeant (Garcia) and I, uh, worked on an operation
630 plan to present to Lieutenant (Caventa), uh, when- once we got back on scene.
631 We filled that out, and once we got back on scene, I gave it to (Caventa).
632

633 Q: What was that op plan?
634

635 A: Uh, basically to continue negotiations in the morning, um, and then to, uh, if
636 negotiations continued to fail and he did not talk with us, that we were going
637 to introduce gas.
638

639 Q: Okay. Brian, while you guys were down there, um, you had shot two rounds,
640 is that correct?
641

642 A: Yes.
643

644 Q: Did you, uh, re-load your magazine?
645

646 A: No.
647

648 Q: Okay. And, um, so about 6:30, you guys return. And, so what goes on then?
649

650 A: Uh, Lieutenant (Caventa) and I met, went over our ops plan. Um, it was
651 decided that EPD would stay in place until about 0800, and then we would
652 move our teams back into position. And from that point, we would, uh,
653 continue with the ops plan that Sergeant (Garcia) and I came up with up.
654

655 Q: Was there any negotiations going on at that time?
656

657 A: No.
658

659 Q: Okay. Um, so 08 rolls around, where does everyone go then?
660

661 A: We switched the teams up because we were going to introduce gas from the
662 number 4 side. And our grenadiers on our team, our gas guys, are Brian
663 Taylor and (Jamie Barney). I wanted both of them of on my team.
664

665 Q: Why don't you put number 2 day down here and who was with you.
666

667 A: So it was myself, (Jesse Taylor), Brian Taylor, and (Jamie Barney).
668

669 Q: Okay.
70

671 A: And (Blake Masaro). And then, (Ireland) and (Lundy) moved up into this
672 position to cover the back door.
673

674 Q: Okay.
675
676 A: And then, uh, (Randy)'s team picked up, um, actually (Bishop) and- and
677 (Tony Gomes).
678
679 Q: Okay. Where was (Lundy) on the, uh, first day?
680
681 A: Here.
682
683 Q: Okay. Um, and was EPD still out in the field then at that time, too?
684
685 A: Yes, they were.
686
687 Q: Okay. Do you know kind of where they were at about?
688
689 A: I do not know. I know they moved their positions during the night. I don't
690 know for sure where they set up, though.
691
692 Q: Okay. And their team leader or commander, I guess, is (Bill Nova)?
693
694 A: Yes.
695
696 Q: Okay. Did you have communications with (Nova) also during this whole
697 thing?
698
699 A: Uh, occasionally, yes. He and I would talk. Um, when it came down to
700 putting into plan our- putting in my plan of action for the next day, I told him
701 that we would need support. He offered up his gas guys to introduce gas, uh,
702 on a different side of the residence.
703
704 Q: Okay. When did negotiations begin again?
705
706 A: 0850 hours.
707
708 Q: And that wasn't (Fridley) and (Daniels) correct?
709
710 A: It was just (Fridley).
711
712 Q: Just (Fridley)?
713
714 A: Yep.
715
716 Q: Did CDC negotiators ever come and help?
717

718 A: Yes they did. They- they moved up at one point. Um, again, I don't know
719 anybody on their team. Um, I got word from the Command Post that they
720 were at the Command Post and, uh, Lieutenant (Caventa) asked I come back
721 there, meet with them, and so I can show them where to set up at. They had a
722 bull-horn. They moved up with their team just in front of this lead vehicle, uh,
723 utilizing shields. They began negotiations from that point utilizing a bull-
724 horn. Uh, I told them that the bull-horn was- wasn't as loud as the PA system.
725 So they moved back to this vehicle, and again, started using the PA system to,
726 uh, try to negotiate with the [REDACTED]
727

728 Q: Okay.
729

730 A: Again, no contact from hi inside the residence. I believe they continued that
731 for about 40 minutes, at which point, they said that there was nothing more
732 they could do, and they moved back. And I escorted them back to the
733 Command Post.
734

735 Q: Okay. And did Sergeant (Fridley) end up doing any more ne- negotiations at
736 that point?
737

738 A: Yes he did.
739

740 Q: Okay.
741

742 A: He continued throughout the morning.
743

744 Q: Okay.
745

746 A: Giving negotia- or asking him to come and talk to us, and then giving
747 surrender commands.
748

749 Q: And nothing from the house?
750

751 A: Nothing from the house.
752

753 Q: Any more movement or anything like that?
754

755 A: Um, occasionally, every once in awhile, somebody would- would hear
756 something, but nothing visual was seen.
757

758 Q: Okay. So at what point, uh, is it decided that, uh, gas is going to be introduced
759 to the house?
760

761 A: When I returned back to the Command; uh, Command Post, I met with
762 Lieutenant (Caventa). At that point, we were going to give him 30 minutes to,

763 um, surrender, uh, then we were going to introduce gas. Uh, I returned back to
764 my team. Notified them of that. Told, uh, Deputy (Barney) and Deputy Brian
765 Taylor to get their gas equipment ready because at the end of 30 minutes, uh,
766 we were going to introduce the chemical agents. During that time, Sergeant
767 (Fridley) was continuing telling him, you got 30 minutes. You need to give
768 up now. Come outside with your hands free. Let us know when you're
769 coming out. Come out the front door on the number 1 side, um, and then, he-
770 he was giving him a countdown. He's got 20 minutes left, 15 minuets left.
771 Uh, when we got to about 15 minutes left, we were told to stand down. Uh,
772 Lieutenant (Caventa) said he was in the process of trying to arrange a
773 helicopter and requested I respond back to the Command Post, which I did.
774

775 Q: What was- why did you want him to come out of the number 1 side, Brian?
776

777 A: That's where we had the most officers. It was an open area, uh, the backside,
778 uh, the number 3 side, where the back door was, I only had two officers back
779 there, and it led into a pretty, uh, overgrown area. We wanted him to come out
780 the front side. It was a wide-open space. Had multiple officers three who
781 could give him some verbal commands, and take him into custody, should he
32 come out that door and- and give up.
783

784 Q: Okay. Um, so and whose decision was it to finally introduce the gas into the
785 residence?
786

787 A: It was Lieutenant (Caventa).
788

789 Q: Okay. And then you passed that decision onto your two gas men who's (Jamie
790 Barney) and Brian Taylor, right?
791

792 A: Correct.
793

794 Q: Okay. What is the plan of what's gonna be used first?
795

796 A: We were going to use a 37 mm, um, ferret rounds, CS gas. The plan was to
797 get five into each window on the A, B or on the number 4 side, the A and B
798 window. Get five rounds each into that.
799

800 Q: And who- who was first to go and do that?
801

802 A: Uh, Brian Taylor.
803

804 Q: Okay. And was he successful in getting the five rounds into each window?
805

806 A: Eventually.
807

808 Q: Did you guys continue firing the ferret rounds into the windows until there
809 was five in each window?
810
811 A: Correct.
812
813 Q: Okay. Any idea on how many?
814
815 A: No. I know for sure, we had, uh, two duds and one misfire. So I- I don't know
816 exactly how many, uh, but we did get five in each window.
817
818 Q: Okay. And is there any response from the house then?
819
820 A: No.
821
822 Q: Nothing?
823
824 A: Nothing.
825
826 Q: Um, what do you do next?
827
828 A: I requested from EPD's team, I believe (Wilcox) was their officer in charge-
829 was their team leader. I asked for him to introduce gas on the number 2 or
830 number 3 side, whatever side he could get access to. And, and then he moved
831 his team into position to do that.
832
833 Q: And did he, uh, shoot into the house?
834
835 A: Yes, they did.
836
837 Q: Okay. And then, did it return back to Brian Taylor again or?
838
839 A: Yes, Brian Taylor, uh, basically, we were to do five and five. Uh, EPD was
840 gonna put five in from this side as well. Um, we ran out of the 37 mm later. I
841 notified Lieutenant (Caventa) that we're gonna have to switch to the 12 gauge.
842
843 Q: Let's back up for one second. How many volleys did you do, Brian?
844
845 A: Just two.
846
847 Q: So, 10 in each window on the number 4 side?
848
849 A: Correct.
850
851 Q: But a lot of rounds didn't make it?
852

853 A: Yes. Um, I actually think the second volley we ended up running out. We
854 didn't actually get 10 into each one.
855
856 Q: Okay.
857
858 A: Or five into each one.
859
860 Q: Okay. And then it was decided by you to put ferret rounds?
861
862 A: I told Lieutenant (Cavneta), because he was asking that once you do these, the
863 volley was done on this side, we introduce five more. I told him that we
864 didn't have any more of the 37 mm, and that we were gonna switch to the
865 ferret round because they were smaller and have less chemical agent, we then
866 were gonna do 10 into each- each window.
867
868 Q: Okay. Okay, and who did that?
869
870 A: Uh, I believe both Deputy (Barney) and Deputy Taylor fired ferret rounds.
871
872 Q: Okay. Was there only one shotgun?
873
874 A: Correct.
875
876 Q: Was there- did you guys have two 37 mms?
877
878 A: We had two, but we only used one.
879
880 Q: Okay. And...
881
882 A: And when EPD, uh, went to deploy gas, they took our 37 mm launcher also
883 with 'em.
884
885 Q: Okay. So did (Barney) and Taylor rotate doing the- the volleys at the number
886 4 side?
887
888 A: Yes.
889
890 Q: Okay. And after shooting the ferrets, 10 in each window is what you say?
891
892 A: I think so, yeah.
893
894 Q: Okay. And, uh, what ends up with all of that after that happens. Is there
895 any...
896

897 A: We're continuing with negotiations, surrender commands. Sergeant
898 (Fridley)'s continuing to get on the PA telling him, now's the time to give up.
899 He needs to come out, again, the front door on the number 1 side. Again, no
900 response from inside the house.

901 Q: Okay. And what goes on next?

902 Q: Lieutenant (Caventa) gets on the radio asking me about the probability of
903 deploying, um, the chemical agent grenades inside the residence. At that
904 point, I started looking at it and trying to get a plan to get us up close enough
905 to deploy those.

906 Q: And a chemical agent grenade would be a hand-held?

907 A: Yes.

908 Q: Okay. And so what was the plan?

909 A: Basically, I told Lieutenant (Caventa), I've looked through my binoculars on
910 both of these windows. We had a pretty good, uh, the number A window was
911 pretty well shot out so I knew we could get one into there. The B window still
912 had a quite a bit of glass in it, so we used the- the ferret rounds to break out
913 the rest of that window. Uh, once that window was sufficiently broken to
914 where we could deploy the, uh, hand-held gas canisters, I told (Caventa) that
915 I, um, needed additional team members down here to cover us on our
916 approach to that side because we had to move through this large, open area,
917 and if he were to pop out and start shooting at us, we were out in the open.
918 We had nowhere to go. He sent down, um, CDC's tactical team. Um, I believe
919 they had four or five guys. They also brought with them a ballistic blanket on
920 a pipe pole that we used as a over and concealment as we moved towards the
921 residence.

922 Q: Okay. Can you- how were the guys positioned when you guys went up there?

923 A: My team?

924 Q: Yes.

925 A: I had Deputy (Masaro) and Deputy Brian Taylor on either end of the pipe pole
926 holding the blanket up. Um, myself, Deputy (Jesse Taylor) and Deputy
927 (Barney) were behind the blanket covering the residence. CDC's team was
928 back at the- the lead Tribal vehicle covering the residence, as well. We went
929 down the road. There's a fence, right in here, a barbed-wire fence. As soon as
930 we got past that, we turned the blanket, uh, parallel, perpendicular with the
931 residence and moved towards it. Um, Deputy (Taylor), (Jesse Taylor) and I
932
933
934
935
936
937
938
939
940
941

942 continue to cover the residence. As we got close to here, Deputy (Barney)
943 deployed the flameless expulsion grenade into the A window. We moved
944 down to the B window, he deployed the second one into there, and then we
945 retreated out the same way that we came in.

946
947 Q: Okay. And then, um, do you know how those work at all?

948
949 A: They work on a CO2 canister. Uh, once the- the pin is pulled, and the- the
950 spoon is released, it sets off a CO2, small CO2 canister inside, and that
951 disburses the chemical agent inside the room.

952
953 Q: Okay, and, um, negotiations is still attempting?

954
955 A: Correct.

956
957 Q: And anything from the residence?

958
959 A: No.

960
961 Q: Okay. And, um, what goes on after those are dropped into the trailer?

962
963 A: Um, I believe it was a CDC, uh, team leader was talking to me telling me that
964 they had additional, um, uh, basically hand-held chemical agent grenades, uh,
965 that were rated for indoor use. They had a smoke element to them. Uh, the
966 smoke helps, uh, move the chemical agent further inside the residence. He
967 had made the suggestion that we use those. Uh, he took his team back up to
968 the Command Post and met with Lieutenant (Caventa). A short time later,
969 (Caventa) told me via the radio that he wanted us to deploy the canisters that
970 CDC had, which were the tri-chamber, flameless, uh, grenade.

971
972 Q: Lieutenant (Caventa) radioed you that?

973
974 A: Yes.

975
976 Q: Okay. And did CDC bring those items down to you?

977
978 A: CDC came back down to my position. They had a black tactical vest that had,
979 uh, two of the flameless grenades, a, uh, stinger grenade and two pyrotechnic,
980 um, grenades, as well.

981
982 Q: Okay. And, what- what- what did you decide to use on that residence?

983
984 A: Um, we decided- I decided that we were going to use the flames- the two
985 flames and the stinger grenade when we made our approach again.
986

987 Q: Okay. Two- two flameless, tri-chambers and one stinger?
988
989 A: Correct.
990
991 Q: Okay. And at that time, did you guys approach at that time the same way you
992 did before?
993
994 A: Well to make sure there wasn't any potential for us to accidentally deploy a
995 pyrotechnic flammable grenade, we removed the items we were gonna use out
996 of CDC's vest and Deputy (Barney) put them on his tac vest. So the only-
997 only, uh, gas that he had on his person when we made our approach was the-
998 was the tri-chamber flameless and the stinger grenade.
999
1000 Q: Okay.
1001
1002 A: I had actually requested from Lieutenant (Caventa) that EPD's team move up
1003 and try to introduce gas from- from an opposite side. I was concerned that we
1004 were patterning ourselves and the suspect may realize that he sees us moving
1005 up again, what we're gonna do, I didn't want to do that. But according to
1006 EPD, they were- they were unable to get any closer to the residence to deploy
1007 gas again. So at that point, CDC, uh, let us use their ballistic blanket again,
1008 and we moved up the same way that we did the first time. Uh, the same
1009 positioning in our- in our stack and basically the same order. Once we got to
1010 the A window, Deputy (Barney) introduced the tri-chamber flameless
1011 grenade. We got to the B window, which is the big open are. My concern
1012 was, again, if, uh, 'cause we were patterning ourselves. If the [REDACTED] knew
1013 we were coming up to do it again, I told (Barney) to deploy a stinger grenade
1014 in there which would've hopefully got him out of that room. Uh, which he
1015 did. Put that in there. That detonated, and then he attempted to introduce the
1016 second tri-chamber flameless grenade. Bounced off the window, landed in the
1017 grass, I picked it up, and then I threw it back through the window.
1018
1019 Q: Um, then you guys returned to where you guys were at?
1020
1021 A: Yes.
1022
1023 Q: Okay. Was there anything- negotiations or anything going on still?
1024
1025 A: Continuing the whole time.
1026
1027 Q: Okay. Um, and any- anything coming from the residence?
1028
1029 A: Smoke.
1030
1031 Q: Okay. Uh, explain that smoke to me.

1032
1033 A: Uh, the tri-chamber flameless grenades, when they go off, they emit a pretty
1034 dense, white smoke. And that's the smoke that we saw coming out both those
1035 windows.
1036
1037 Q: And why the smoke more than the aerosol or CO2?
1038
1039 A: The smoke carries the- the chemical agent better than just disbursing it into
1040 the air.
1041
1042 Q: Okay. And what happens after that smoke dissipates?
1043
1044 A: Um, CDC is now taken up our positions at this number 1 vehicle, and they're
1045 covering that side. Um, again, (Caventa) asked to meet with me. I go back up
1046 and meet with him. Um, he has formulated a new plan that he was gonna get
1047 in contact with the FBI. Have them bring up their armored personnel carriers.
1048 Our- our team was gonna have to leave the scene at 1700 hours that day,
1049 return at 0700 hours and hopefully with the assistance of the FBI, be able to
1050 move up closer to the residence and- and proceed the next day. As I was
1051 talking to Lieutenant- Lieutenant (Caventa) about that plan, CDC said that
1052 they could see black smoke, uh, coming from, uh, either the A or B window, I
1053 don't recall which one. I believe their team leader said that they thought they
1054 saw the subject in there lighting a fire.
1055
1056 Q: Okay. When you- when you say, lighting a fire, did you ever hear anything
1057 more. Like a fire in a fireplace or a fire...
1058
1059 A: That's all I heard.
1060
1061 Q: Okay. And, um, do you return to that location then?
1062
1063 A: Yes, I do.
1064
1065 Q: Okay. And what do you observe?
1066
1067 A: I can see, um, small amounts of black smoke coming out of both windows. At
1068 that point, Sergeant (Fridley)'a on the PA telling, uh, Mr. () that he
1069 needs to come out now. Uh, there's a possibility that the place may be on fire.
1070 Uh, he's- he just needs to come out.
1071
1072 Q: And that never happens?
1073
1074 A: No.
1075
1076 Q: Um, at what point, do flames start to appear?

1077
1078 A: Yes.
1079
1080 Q: From where does that happen at?
1081
1082 A: The first time I saw flames, it came out of the- the B window. Uh, and it was
1083 right at the top of the window and hitting the eave of the- of the roof.
1084
1085 Q: Okay. And when you first saw flames, Brian, how long was it until that house
1086 or trailer was fully engulfed?
1087
1088 A: It took a while. Um, it's- it's hard for me to say because I couldn't see the
1089 back side of this house. Like I said, I could only see about a quarter of the
1090 way down the number 3 side. But I would say, from the first time we saw the
1091 black smoke coming out of here to when this section was fully engulfed-
1092 engulfed, probably 1/2 an hour, 45 minutes.
1093
1094 Q: Okay. And when, although the end result, the house or the trailer eventually
1095 fully engulfed, and most of it burns down. Um, and at that tie, you guys
96 return and you have your weapons check and all that?
1097
1098 A: Correct.
1099
1100 Q: Okay. I don't think I asked you this, Brian, as far as your training for SWAT,
1101 what is that? What have you done?
1102
1103 A: Forty hours of basic SWAT, 40 hours of advanced SWAT, 40 hours of SWAT
1104 team leader, and 48 hours of tactical deployment officer.
1105
1106 Q: Okay. And, um, as far as the gas being thrown in, would you say- do you
1107 have any idea why it was ineffective on [REDACTED]?
1108
1109 A: You now, it can be for a number of different reasons. If we weren't getting
1110 the saturation levels to- to move through the rest of the residence. If he had
1111 barricaded himself into a room, uh, if he had a chemical- had a gas mask, it
1112 would have been ineffective. If he barricaded himself in a room and put wet
1113 towels around the door, wet towels over his face, uh, that could've, uh, made
1114 it less effective.
1115
1116 Q: In your experiences on being on SWAT Teams, or SWAT Team, um, have
1117 you ever seen that before where suspects have been barricaded, um, and gas is
1118 introduced, and they don't come out?
1119
1120 A: Yes.
1121

1122 Q: How many times have you seen it?
1123
1124 A: Um, the most recent one I could think of is the Super 8 incident.
1125
1126 Q: Okay. And, um, in situations like this, and I don't know if the negotiators
1127 have been asked this, since you are a team leader, um, why not let a family
1128 member or a friend talk to [REDACTED]?
1129
1130 A: Because a lot of times -- well first of all, the way that this was set up, it would
1131 put them in- in a very dangerous position. They would've been in the line of
1132 fire with [REDACTED]. It could agitate the situation. We don't know what is going
1133 on between those family members. Uh, and there have been times that during
1134 negotiations, they talk to a family member, it could send them over the edge
1135 and create a violent situation.
1136
1137 Q: When- are you saying, that um, you let someone talk to someone and you
1138 don't know the history between those two, you might think it's okay,
1139 evidently for that [REDACTED] it's not okay?
1140
1141 A: Right.
1142
1143 Q: They don't even want to talk to that person?
1144
1145 A: Correct.
1146
1147 Q: Could've even been the person that set that person off?
1148
1149 A: Yes.
1150
1151 Q: Okay.
1152
1153 A: And- and because we- he had never even started a dialogue with us. So, we
1154 weren't ever even able to establish what was going on with him, and we
1155 weren't going to throw in an unknown element like that without at least
1156 having talked to him and figured out where he's at, uh, what's going on with
1157 him, and what the whole situation was.
1158
1159 Q: Okay. Um, why didn't you have your SWAT Team enter and try to subdue
1160 him that way?
1161
1162 A: It was too dangerous.
1163
1164 Q: Okay. Is that because he's already shot at you guys twice?
1165

1166 A: Correct. Based on that fact and the number of weapons that he's supposed to
1167 have inside the residence.
1168
1169 Q: Brian, tell me about those weapons.
1170
1171 A: We got information that he had an AR-15, and AK-47 or SKS-type rifle, uh, a
1172 .22 rifle with a scope on it, and a handgun. When we made our approach the
1173 first time on the A window, we observed a handgun sitting on a shelf next to
1174 the window. It was a large silver revolver. Um, again, we didn't now exactly
1175 what he had in there, but that was the information we had that he had those
1176 weapons.
1177
1178 Q: Okay. As far as you guys and the, uh, Eureka SWAT Team, do you guys-
1179 have you guys ever trained together before?
1180
1181 A: No.
1182
1183 Q: And- but have you guys ever been on missions together before?
1184
1185 A: Yes we have.
1186
1187 Q: From what I know, numerous ones?
1188
1189 A: Yes.
1190
1191 Q: Okay. When Deputy (Barney) threw the tri-chamber grenade and you picked
1192 it up, how hot was it?
1193
1194 A: It was warm.
1195
1196 Q: Do you know anything more about those kind of flameless chamber grenades?
1197
1198 A: Uh, no I don't.
1199
1200 Q: Okay. But from what you understand, it is, um, is it considered pyro-
1201 pyrotechnic?
1202
1203 A: I believe it is considered a pyrotechnic, but it is safe for use indoors.
1204
1205 Q: And, if I understand this right, the flame is contained inside of the can?
1206
1207 A: Correct.
1208
1209 Q: Okay. A fire's been mentioned several times. Did you ever notice smoke
1210 coming out of a chimney or anything like that?

1211
1212 A: No.
1213
1214 Q: Okay. And as far as, um, the pyro- pyrotechnics, was there ever mention
1215 about using them at all?
1216
1217 A: Yes there was.
1218
1219 Q: When was that?
1220
1221 A: Lieutenant (Caventa) said that if as we were making our approach to
1222 introduce, uh, the non- or the flameless, uh, chemical agent, if we were to take
1223 rounds again, at that point, we were authorized to introduce the use of the- the
1224 pyrotechnic chemical agent.
1225
1226 Q: Okay, but you did not take any of those even up there with you?
1227
1228 A: No, we did not.
1229
1230 Q: Okay. When you were down by the- the- the Tribal car, Brian, and those
1231 shots rang out and you saw the gun with the sock or whatever the heck it was
1232 on there, um, what were you thinking?
1233
1234 A: I was in fear for my life.
1235
1236 Q: Do you think he was, uh, trying to kill you guys?
1237
1238 A: Yes, I did.
1239
1240 Q: He'd already -- I guess I- he already knew at one point there were cops there?
1241
1242 A: Yes.
1243
1244 Q: Okay. Did you hear anything about a scope- he had a scope on his gun?
1245
1246 A: Yeah, the .22 rifle apparently had a scope on it.
1247
1248 Q: You're familiar with guns, aren't you?
1249
1250 A: Yes, I am.
1251
1252 Q: Um, I don't know how well you heard the rounds that were shot, but what
1253 would you say shot those?
1254

1255 A: Uh, you know, I- I can't say for sure. The one round that he fired at us, um,
1256 when I was down by that front vehicle, uh, sounded like it could've been a
1257 .22.
1258
1259 Q: Okay. And- and in your training with your M-16, um, do you train with that?
1260
1261 A: Yes, we do.
1262
1263 Q: As a SWAT Team?
1264
1265 A: Yes.
1266
1267 Q: And, how do you qualify with that?
1268
1269 A: We qualify- we do our department qualifications, uh, five rounds, uh, at a
1270 silhouette target at 100 yards and all five rounds need to be into the head.
1271
1272 Q: And is that documented?
1273
1274 A: Yes it is.
1275
1276 Q: Okay. And Brian, are you in charge of documenting, uh, your guys's set
1277 training? Or is it documented?
1278
1279 A: Yes, it is, and yes I am.
1280
1281 Q: Okay. And do you guys keep an inventory of- of, I guess your CS gas or all
1282 gas that you guys have?
1283
1284 A: Yes, we do.
1285
1286 Q: And, we can go and look at that and see what exactly was used there?
1287
1288 A: Uh, we should be able to.
1289
1290 Q: Okay.
1291
1292 A: I'm not sure who has the inventory at this point because we- we're in the
1293 process of switching over. Previously, Sergeant (Miller) was our gas guy, and
1294 we just recently sent Deputy Brian Taylor and- and (Barney) to the gas school
1295 and they're in the process of taking over. I don't know if Sergeant (Miller)
1296 still has our inventory or if it's changed hands already. But, we were in the
1297 process of getting an update on our inventory.
1298

1299 Q: Okay. And, Brian, in your own opinion, um, is there anything else that you
1300 feel that could've been done, um, to get [REDACTED] to come out of that
1301 residence?
1302
1303 A: No.
1304
1305 Q: Okay. Steve?
1306
1307 Q1: You talk about getting a rifle out of the trunk when you first arrive on the
1308 scene?
1309
1310 A: Yes.
1311
1312 Q1: What kind of rifle is it or I've heard Detective mention M-16, is that what you
1313 carry?
1314
1315 A: It's an M-16, A2 Colt Commando.
1316
1317 Q1: What kind of sighting do you have on that?
1318
1319 A: It's (unintelligible) holographic site.
1320
1321 Q1: Is that the one with the triangle?
1322
1323 A: Yes.
1324
1325 Q1: And, kind of going back to what the Detective said, did- are you the one
1326 responsible for all training records?
1327
1328 A: I am- I am responsible for setting up the training and documenting the training
1329 for our team. I'm not responsible for the department-wide qualifications that
1330 we do. Uh, the team does train more often with our rifles than the rest of the
1331 department does, and I- and I am responsible for all that documentation
1332
1333 Q1: And, as for the department, who would that person be?
1334
1335 A: I believe (Roy Reynolds) is our head range master.
1336
1337 Q1: Um, as we go throughout this interview with you, I notice you've been
1338 looking at some paperwork in front of you, it looks like a log?
1339
1340 A: Yes.
1341
1342 Q1: What is that?
1343

1344 A: It's a log from our radio communications that Dispatcher () types up
1345 from that night or from those days.
1346

1347 Q1: So Dispatcher () keeps a- safe to say, a rolling log of the events as they
1348 occurred?
1349

1350 A: Yes.
1351

1352 Q1: Um, as we look at this diagram, too, just to clarify some of the- the view that
1353 different people have, including the sniper, this is, you said a bit off in regards
1354 to what the actual view is from this vehicle than as it appears here?
1355

1356 A: Correct.
1357

1358 Q1: Could you draw a line on here that would represent number 4 side? Um, not
1359 necessarily the whole thing, just the number 4 side because it kind of -- you
1360 talk about seeing 1/4 of number three side?
1361

1362 A: Mm-hm.
53

1364 Q1: The view of number 4 side?
1365

1366 A: Right.
1367

1368 Q1: And you also have some different snipers at different points on the 3 side who
1369 actually have a visual of the 4 side?
1370

1371 A: Yeah, they, um, Deputy (Ireland) had a visual, but he didn't have a shot at the
1372 guy. He could see the guy, but due to the angle, he didn't have a clear shot at
1373 it, and could actually see him because of the way the- the building is laid out.
1374 Like I said, it's- it's more turned like that, um, so the A, the 4 side is pointed
1375 more towards these vehicles down here than straight up and down with the
1376 road.
1377

1378 Q1: Could you draw one- a line then just representing each- each of these quarters
1379 of the number 4 side by about how your view would be from that?
1380

1381 A: I'd say it was more like that.
1382

1383 Q1: Okay. Um, there was some mention of a subject, he could've been possibly
1384 lighting a fire and folding some clothes and stuff. All those times, and when
85 that occurred that would be all on the log back from the dispatcher?
1386

1387 A: Yes. It should be on the log.
1388

1389 Q1: In talking about having one shotgun, um, used to, uh, deploy some of the
1390 chemical agents used?
1391
1392 A: Mm-hm.
1393
1394 Q1: Um, did you ever deploy any of the chemical agents at all?
1395
1396 A: Well...
1397
1398 Q1: Other than the hand-held?
1399
1400 A: No.
1401
1402 Q1: Okay. Um, and then you talk about the different approaches, uh, two different
1403 approaches where you, um, actually approached the number 4 side of the
1404 structure with a blanket- a ballistic blanket- type that the CDC guys had. Um,
1405 the first deployment- the- the hand-held gas that you guys used, that was your
1406 gas?
1407
1408 A: Correct.
1409
1410 Q1: And the second round of deployment would've been, uh, those were the tri-
1411 chamber flameless from CDC?
1412
1413 A: Correct.
1414
1415 Q: And there was a stinger.
1416
1417 Q1: And there was a stinger, as well from the CDC?
1418
1419 A: Yes.
1420
1421 Q1: What's the purpose of the- the stinger in relation to the deployment? Um,
1422 what was your strategy in regards to the deployment of the stinger along with
1423 that gas?
1424
1425 A: Like I said, I was concerned because we were patterning ourselves. We'd
1426 already made the same approach once. And, my concern was that if he was
1427 inside this area here, and he- he knew we had already deployed gas into this A
1428 window, that if he was gonna make a move on us, it would probably be from
1429 the B widow. So I wanted that stinger to go in there because it contains the
1430 rubber pellets and chemical agents. I wanted that to go in there to move him
1431 out of that room, so we could safely deploy the second, uh, tri-chamber
1432 grenade in here, and then make our retreat.
1433

1434 Q1: You also talk about, uh, Deputy (Barney) throwing one and actually missing
1435 or actually missing and bounced off.
1436
1437 A: Yeah.
1438
1439 Q1: And you reached down and picked it up?
1440
1441 A: Yes.
1442
1443 Q: And it was warm. Did it burn your hand?
1444
1445 A: Uh, made my finger a little pink, but it wasn't burned.
1446
1447 Q1: It wasn't burned. Did you have to, um, to put yourself in a situation away
1448 from cover to dot that?
1449
1450 A: Yes I did.
1451
1452 Q1: You also made mention, uh, some experience, uh, with these different types of
53 hand-held gases, the ones you refer to at Super 8?
1454
1455 A: Yes.
1456
1457 Q1: What was that?
1458
1459 A: It was the- the Super 8 incident with (██████████) I know we had
1460 deployed a large amount of chemical agents into a relatively small hotel room.
1461 And the ██████████ was able to maintain in there for quite a long time before he
1462 actually eventually acme out.
1463
1464 Q1: And you were there when that occurred?
1465
1466 A: Yes I was.
1467
1468 Q1: Do you know what- what kind of gas they used for that incident?
1469
1470 A: I believe it was the same 37 mm ferret rounds.
1471
1472 Q1: And from- from being there and you believe from that incident, did those-
1473 those same ferret rounds smolder or cause smoke or any fires in that particular
1474 room?
1475
1476 A: No, they did not.
1477

1478 Q1: You also talked about, some at one point, you guys had discussed using some
1479 pyrotechnic type, uh, gas?
1480
1481 A: Yes.
1482
1483 Q1: What's different about that versus the flameless or non-flammable type?
1484
1485 A: It- it has an open flame. It- it- that's how it releases the chemical agent. It's a
1486 flame that is open and it- and it sets stuff on fire. It burns a lot hotter.
1487
1488 Q1: Do you know from your experience, how much more- how much more
1489 effective that would be versus the flameless pyrotechnics?
1490
1491 A: I believe- I believe it's much more effective but it's not intended for indoor
1492 use. It's intended for crowd control and- and open areas. It disburses a lot
1493 more chemical agent than the flameless kind.
1494
1495 Q1: That's all I have.
1496
1497 Q: Okay, Brian, you brought some of these things in- the .40- the ferret .40, the
1498 ferret 12, flameless (unintelligible), the expulsion grenade, the stinger grenade
1499 and tri- tri-chambered flameless grenades. Were all these used, um, on this
1500 day in question?
1501
1502 A: Yes they were.
1503
1504 Q: And, um, and can you write on them on the- in one of the corners just which
1505 one were ours EPD was using if you know that and the CDC. And then after
1506 we're done, you can run us over and maybe could see how many of those left.
1507
1508 Q1: While you're doing that, Sergeant.
1509
1510 A: Mm-hm.
1511
1512 Q1: You talked about, when the Detective asked you how many actually
1513 deployment you had with the 12 gauge ferret type rounds, you don't know the
1514 exact number?
1515
1516 A: No we did- I know for sure that we did 10 and 10 in each window. Um, but
1517 like I said, we needed to break out another one of those windows prior to
1518 deploying the hand-held gas canisters, and I believe it took anywhere between
1519 five and six additional rounds with the 12 gauge ferret to break out that
1520 window
1521

1522 Q1: So, what's- at some point in time obviously the structure is on fire, and you
1523 guys move back. Um, did you yourself order anybody or does anybody pick
1524 up any of these rounds still on the ground or are those left there?
1525
1526 A: We left where they were.
1527
1528 Q1: So whatever would be on that ground in that area where those were deployed
1529 would be probably and accurate amount of whatever was actually fired against
1530 that number 4 side?
1531
1532 A: Correct. They would've been right next to this vehicle here on this side of the
1533 road, the south side.
1534
1535 Q1: You're pointing to what looks like the Hoopa Valley Police vehicle which is
1536 the very first vehicle?
1537
1538 A: Yes.
1539
1540 Q1: Towards the house? Okay, to the best of your knowledge, none of those,
41 we'll call them shell casings, were picked up and none of the ones from the
1542 M-16 were picked up?
1543
1544 A: My guys were instructed not to pick up anything.
1545
1546 Q1: Okay.
1547
1548 Q: Can you sign that for me, Brian? Brian, is there anything that you can think of
1549 that, uh, we haven't asked you or would be important for us to know or
1550 anything you'd like to add?
1551
1552 A: I don't think so. I think that's it. We did everything we could to resolve this
1553 peacefully.
1554
1555 Q: Okay. Paul you have anything?
1556
1557 Q2: Real quickly, um, Sergeant, did you hear any rounds going off at any time
1558 after the structure was on fire?
1559
1560 A: Yes I did.
1561
1562 Q2: Okay. Were you able to tell whether he was firing at you or they were just
1563 cooking off?
1564
1565 A: We could not tell.
1566

1567 Q2: Okay. Is that the basis for withholding any fire suppression?

1568
1569 A: Yes.

1570
1571 Q2: That's all.

1572
1573 Q: Okay, we'll end the interview at 1412 hours.

1574
1575
1576 This transcript has been reviewed with the audio recording submitted and it is an accurate
1577 transcription.

1578 Signed _____

1
2
3
4
5
6
7 **INTERVIEW WITH TIM JONES**

8 Q=Det. Rich Schlesiger

9 Q1=Steve Dunn

10 A=Tim Jones

11
12
13 Q Okay date is June 6, 2007; time is 0937 hours, case 200703162. Uh, myself
14 and Investigator Dunn are here with Officer Tim Jones of the (Eureka) Police
15 Department and uh, we'll call it the SWAT Office. Um, Tim uh, what's your
16 call sign and badge number?

17
18 A 38067.

19
20 Q Okay. Um, how-how long have you been in law enforcement?

21
22 A A total of eleven years. Been at (Eureka) for almost eight and a half.

23
24 Q Okay and um, w-what are you currently assigned to at the Police Department?

25
26 A Uh, currently assigned as an (FTO) on patrol. Uh, assigned to the SWAT
27 Team.

28
29 Q Okay. And uh, how long have you been on the SWAT Team?

30
31 A It has been coming up on five years I think.

32
33 Q Okay and um, what's your position with the SWAT Team?

34
35 A Um, I do uh, chemical agent deployment entries and I'm training for sniper.

36
37 Q Okay.

38
39 A With the sniper team.

40
41 Q Okay this last uh, weekend I believe it was on the 3rd um, obviously the (SO)
42 called out you guys for some assistance. Can you-can you just start from
43 getting the call, were you working, were you at home?
44

45 A I was at home uh, Sunday evening from around 815-830 got a page um, from
46 dispatch saying that we needed to call Sergeant (Nova) at home in regards to
47 an agency assist with the Sheriff's Office.
48
49 Q Did you work that-that Sunday?
50
51 A No, no.
52
53 Q That was your day off?
54
55 A That's one of my days off.
56
57 Q Okay. Um, so you called (Nova) and then did he tell you to meet here or what
58 went on from there?
59
60 A Uh, talking to him uh, he told me we had to go assist the Sheriff's Office up in
61 (Pupa) um, they'd already had shots fired – by then they had had shots fired
62 one time and we were going to meet here and leave here at about 1230.
63
64 Q Okay. And so you guys came here – met here and headed up to (Pupa)?
65
66 A Yes.
67
68 Q Okay. Um, you guys arrived there – the SWAT Team and got all your
69 equipment on and all that and then what do you guys do next?
70
71 A Uh, they gave us a quick briefing on the location. Um, we split up into teams.
72 Um, cause we needed to relieve the (SO) guys, give them a break because
73 they'd been there for some time. So they split us up into teams um, sent us to
74 our respective locations um, then we went each team individually went and
75 spoke with the guys we were relieving.
76
77 Q Okay and nobody was in charge of-of your guys' SWAT Team?
78
79 A Yes.
80
81 Q And you guys have team leaders and assistant team leaders?
82
83 A Yes.
84
85 Q Okay. Um, so when you-you guys were deployed um, were you deployed to
86 take over the locations of the (SO's) SWAT guys?
87
88 A Yes.
89

90 Q Okay. W-were did you guys go?
91
92 A We went um...
93
94 Q Or were did you go with what guys I should say?
95
96 A I went with....
97
98 Q Here I'll show you this.
99
100 A (Todd) - I'm trying to remember who was there.
101
102 Q Here's a little great little diagram we made here.
103
104 A Okay.
105
106 Q And here's were...
107
108 A Oh okay.
109
110 Q You'd started...
111
112 A Command post up here.
113
114 Q Yeah, command post and the house.
115
116 A Okay, we went um, (Greg Hill), (Todd) and I think Sergeant (Nova) and I um,
117 went to the first the forward most (Hoopa Valley) um, Tribal SUV and that's
118 were we met up with um, the (SO) guys.
119
120 Q Okay. Could you put a little mark on there?
121
122 A Yeah.
123
124 Q Put just uh, one - were you had started.
125
126 A Okay. Uh, lets see we were actually moved up to here.
127
128 Q Okay. So you relieve those guys at that location.
129
130 A Mm-hm.
131
132 Q And what you-what you guys do from there?
133

134 A Um, we got some information from them. They told us you know, kind of
135 what had occurred, gave us some — a little more first hand information.
136

137 Q This had to have been around 3 am, you probably arrived somewhere around
138 there.
139

140 A It was somewhere around three, yeah.
141

142 Q Okay.
143

144 A Um, they told us you know, what kind of coverage they had um, and so we
145 you know, they were sharing their equipment, their night vision um, so we
146 could use that uh, to take observations on the house. Um, they'd pointed out
147 you know, from window A that that's where the shots had come from.
148

149 Q Okay.
150

151 A Um, kind of told us a little bit of the history you know um, that the lights were
152 on in window B, the lights were dark — the lights were out in window A,
153 however it looked like maybe there was a television or something on because
154 they kept seeing some flashing in there um, and so just kind of giving us an
155 idea of you know, what to look for and gave us a little bit of history so if
156 things changed, we'd have some idea whether it was a pattern or not.
157

158 Q So did — at this location it was you, (Hill)...
159

160 A And (Wilcox) was there.
161

162 Q Okay and that was it?
163

164 A Sergeant (Nova) came down uh, I think he came down for a moment um, (Ron
165 Harpem) and (Gary Cooper) came down but then dropped off -- dropped off
166 down over the hill and came around so they would have observations on the
167 number one side.
168

169 Q Okay. Um, did you guys stay there the entire night at this location?
170

171 A We did. Um, till about sun up.
172

173 Q Okay.
174

175 A And then we were —or we were kind of compromised cause we didn't you
76 know, those were the cars that had been shot at so we were obviously within
77 his range um, not knowing what armaments he had uh, when sun up came we

178 fell back to the other two uh, I think there was one was an (SO) car and one
179 was maybe (Hoopa) Tribal.

180
181 Q Okay.

182
183 A The car -- we fell back just a little ways.

184
185 Q At that point you would have lost sight of the house?

186
187 A Um, yes we lost sight of it from there.

188
189 Q Okay. While you guys were here Tim, did you guys uh, what-what did you
190 hear or observe while you guys were standing there during that night?

191
192 A Um, we had with the night vision goggles um, you could see um, some lights
193 flashing you know, kind of like what a TV would look like or something like
194 that in window A. Um, the lights were on in window B and occasionally you
195 could see movement -- I could see movement through window B, but I
196 couldn't really tell what it was. It looked like somebody moving around, but
197 it looked like it was in the room a ways, not actually at the window.

198
199 Q Okay.

200
201 A Um, not enough were I could tell what was-what was actually happening.
202 You could tell like a direction of travel he's going left or right, but that was
203 about it.

204
205 Q Okay and you couldn't hear anything?

206
207 A Um, not anything that stands out.

208
209 Q Okay. So you guys move back here at daybreak, back were these other units
210 probably were um, how far would you say from the front of the Tribal
211 vehicle?

212
213 A Um, hm, shoot. From the front car, 30-40 yards maybe.

214
215 Q Okay.

216
217 A Um, and one thing I should mention uh, I initially came up here to this
218 position one um, that mark is a one with my uh, my (AR15).

219
220 Q Mm-hm.

221

222 A Um, however when I got there um, I really wasn't -- I couldn't see the-the site
223 that I had on there -- the red dot site that I had on there, doesn't have any
224 magnification so I went back and got my 308 that has some magnification and
225 brought it back so maybe I could uh, see a little bit better through the windows
226 um, and so that's where I was using my 308.

227
228 Q Okay. And um, when you guys moved back here, what-what goes on next?
229

230 A Um, we really didn't have any visual observations on that side. However, we
231 knew that um, there was another team somewhere up in this area.

232
233 Q Somewhere up in the -- by the three side somewhere?
234

235 A Yeah they were almost straight back from what would have been window A
236 uh, on the three side.

237
238 Q Okay.
239

240 A Um, and they were guessing it to be about 35 yards, 40 yards maybe. So um,
241 we knew that they had -- and there was a window here -- window A which
242 went into this corner it looked like cause it was real close to the three-four
243 corner.

244
245 Q Okay.
246

247 A Um, so we're comfortable with knowing that you know, they had -- sounded
248 like they had observations on this window -- on this whole side so they could
249 see into here. Um, so we fell back into position where we actually had some
250 cover um, and just stood by for a little bit. Um, we took a break, got off our
251 feet. Um, then we kind of rested for a little bit.

252
253 Q Okay. So, did the -- eventually the-the (SO) guys come over and take over for
254 you guys?

255
256 A Yes they did.
257

258 Q Okay. And you guys took a break and when-when again were you guys
259 deployed?
260

261 A Uh, we took a break for a little while um, as far as times goes, I'm not entirely
262 sure. Um, the uh, it seems like we were-we were down for an hour or so.
263 Um, we got some rest and then we got back up and they were uh, planning on
264 uh, gas delivery.

265
266 Q Okay.

267
268 A Um, they wanted (Luis Altick) who is also one of the uh, chemical agents
269 deployment guys for the team um, they wanted he and I to set up so we could
270 assist with gas delivery if necessary. But as far as the amount of times that –
271 the amount of time we were down and what times (unintelligible) I couldn't
272 even begin to tell, I didn't look at my watch.
273
274 Q Okay. Um, so eventually you guys are deployed back out, right?
275
276 A Yes.
277
278 Q Okay. Are you with the same team? Who-who are you with?
279
280 A At that point, I was with (Altick).
281
282 Q Okay. Just you two?
283
284 A Um, there was – I think there was more than-more than that because uh, there
285 was -- trying to remember -- I think uh, I know I was with (Altick) and it
286 seemed like the majority of our team went down to the first two the patrol cars
287 not the SUV's um, while the Sheriff's Department was up here at the SUV's
288 um, and the idea was they were going to do the gas deployment and if they
289 needed assistance um, then -- they weren't sure if they were going to be able
290 to get uh, get good hits into the windows from that distance or if maybe they'd
291 have to move up here. So we were just kind of – we were just kind of going
292 to fill in wherever they needed us.
293
294 Q Okay.
295
296 A Um, so but then we had uh, almost an hour stand down time cause they were
297 waiting for the helicopter.
298
299 Q Okay. And what – were-were did you guys go after you guys were waiting
300 for that to go on? Did you – did they start putting gas into the house or?
301
302 A Um, yes, while we were-while we were up here um, if I remember right, it
303 seems to me it was I think our whole team up here by the two patrol cars.
304
305 Q Okay.
306
307 A And while we were there, they started gas deployment here.
308
309 Q Okay. Was there any negotiations going on or attempts for negotiations?
310
311 A Yes, after um, I think it was about after every deployment of-of the gas.

312
313 Q Okay.
314
315 A They'd get on the PA System and uh, try to talk to him.
316
317 Q Okay and the-the (SO) was deploying the gas from this location at the first
318 Tribal vehicle?
319
320 A Yes.
321
322 Q Okay. Do you recall who-who was doing that?
323
324 A I don't know their names. Um, I think it was (Cornell) but I don't know their
325 names.
326
327 Q Okay, okay. So there's-there's numerous rounds put into the side four of the
328 house then, is that correct? Numerous?
329
330 A They were-they were shooting at side four uh, deploying at side four and I-I
331 couldn't - since we were back here - I couldn't see where their hits were
332 landing. Um, they were reporting that the rounds were going through the
333 windows and they were getting good hits.
334
335 Q Okay. And during that time, is there any communication that you hear that
336 there's somebody moving inside or anything like that?
337
338 A Not anything that I can recall.
339
340 Q Okay. Um, eventually you and (Altick) are-are deployed out somewhere else
341 from-from here, is that correct?
342
343 A Yes.
344
345 Q Okay, were do-were do you guys go?
346
347 A Um, they determined that we would best be served um, by trying to deliver
348 gas into the number two side.
349
350 Q Okay.
351
352 A And so uh, we went back up to the command post uh, because they're really
353 only two routes there. The one dropping off down the hill and going around
354 really wasn't feasible so we went back to command post and up the hill by the
355 big cross and then came back around uh, down the back side of the hill to
356 where we could get a view of the number two side.

357
358 Q Okay. And who-who was with you and (Altick) there?
359
360 A Um, we had (Gary Cooper), (Mike Johnson), (Todd Wilcox), uh, it was our
361 whole team I think and uh, (Ryan Herquin).
362
363 Q Okay. And-and-and you're at this location in number two, how far away are
364 you from side number two?
365
366 A 81 yards.
367
368 Q How did you determine that?
369
370 A I used (Ronny's) uh, laser range finder.
371
372 Q Okay. Um, what did you guys do next then?
373
374 A We got set up. Um, we masked up. Uh, we positioned our uh, people so we
375 would have good cover uh, well so we would have lethal cover. Really didn't
376 have -- well we had no cover to speak of. All we had was (Macino) through
377 the bushes, but while we're deploying the gas, we had to be exposed um, out
378 in the open somewhat so we could get-get rounds to the house. Uh, we
379 waited. We waited for the orders from command. They told us you know,
380 what they wanted and.
381
382 Q Who was that that told you what they wanted?
383
384 A Uh, Sergeant (Nova) gave us-gave us the orders.
385
386 Q Okay and the orders were to go ahead and start putting what into where?
387
388 A There was one window on the two side um...
389
390 Q Where was that at?
391
392 A It was fairly close to the center of the two side.
393
394 Q Okay.
395
396 A Maybe just a little bit toward -- closer to the two three corner, but more or less
397 centered. Um, I believe they wanted -- they wanted five rounds in.
398
399 Q Okay. And-and how-how where those delivered?
400

401 A Uh, (Luis) and I split it up. He was going to shoot two and I was going to
402 shoot three through the uh, 37 mm launcher – single action launcher. We
403 borrowed the – we have one launcher with a full stock and one with a pistol
404 grip, so we borrowed the Sheriff Departments extra um, fully stocked 37 mm
405 that's identical to ours.
406

407 Q Okay. And were you guys alternating or did one do two and the other do
408 three?
409

410 A The idea was that we would just alternate since I had three, I started first.
411

412 Q But yours is – your guys was a single – it's a single load...
413

414 A Yeah it's a one shot and it's a brake action um, you load one round in, you fire
415 it and then you got to break it open, take it out, load in another one, so its not a
416 fast process.
417

418 Q Okay.
419

420 A So the idea was to alternate so we could have a steady uh, steady delivery of
421 fire.
422

423 Q Okay. So those-those five uh, first rounds are delivered in number two.
424 Could you see them entering the house?
425

426 A We were getting about a 30% hit rate on to the window. Um, they were
427 outside the-outside the effective range.
428

429 Q What is the effective range?
430

431 A From my experience, it's been within 50 yards.
432

433 Q Okay. Um, is that still stretching it at 50 yards?
434

435 A Well you know the front side will start to cover up a window it – you know
436 once you get out that way. Um, but you know, the-they're smooth board-
437 smooth board delivery you know, gas guns so there's no rifling in it, they're
438 not really being stabilized all that well so they don't really fly incredibly true.
439 So I – you know, 50 yards is doable um, i-ideally I like to be at or within 50
440 yards.
441

442 Q Okay. And you guys were at 81?
443

444 A 81 yeah. That was as close as we could get without compromising ourselves.
445

446 Q Could you- could you see any other route -- were you making it through the
447 window or were the?
448
449 A We made it through like I said, with uh, about 30% -- well it was right at 33%.
450 A third of the rounds we fired went into the window.
451
452 Q Okay. Did you- did you fire any more rounds into this number two location?
453
454 A We fired a total of 21 rounds at the two side.
455
456 Q Okay.
457
458 A Uh, seven of them went in.
459
460 Q Okay. So um, you shoot the first five, you guys.
461
462 A Mm-hm.
463
464 Q Okay and are you contacted by (Nova) again to shoot another five or how --
465 how does that go about?
466
467 A They wanted uh, I think he wanted a second hole which is um, I think the first
468 time we got three of them in if I remember right and uh, we told him that we
469 were uh, you know we're pushing the limits of the equipment uh, accuracy
470 wise um, so they went with that and then I believe they picked up negotiations
471 again over the PA off the SUV um, and then we got another command for, I
472 think it was five more and it seems to me we got, I can't-I can't recall I don't
473 remember how many rounds we fired, but it seemed like that time we got four
474 in.
475
476 Q Okay.
477
478 A Four into ...
479
480 Q But you had a total of 21 you shot?
481
482 A 21.
483
484 Q And you got seven in through the window?
485
486 A Seven in through the window.
487
488 Q Okay and so you -- or I'm just trying to ask I think is uh, how many different
489 bores did you do?
490

491 A From there I think we did two.
492
493 Q Two? Okay.
494
495 A If I remember right.
496
497 Q So do you guys go from – so two would have been, you shot ten in from the
498 number two side right?
499
500 A You mean ten rounds on the second bole or?
501
502 Q Ten all together.
503
504 A Ten all together um, well we shot seven in through the number two window.
505
506 Q Okay. So you-you-you guys stay here, you never moved over to the three
507 side?
508
509 A No we did move to the three side after the second...
510
511 Q Oh okay.
512
513 A Cause we were – we just -- it wasn't becoming effective because you know,
514 they were missing, they were hitting the side of the house, they were ...
515
516 Q Just bouncing off?
517
518 A Yeah apparently they – some of them had unbroken at the base of the house
519 um, just watching them fly, it was – we were wasting.
520
521 Q Okay.
522
523 A (Unintelligible).
524
525 Q So pretty much you guys are here – is there-is there-is there a certain breaks,
526 do you guys take a couple breaks and there's negot – attempts to negotiate or
527 surrender orders?
528
529 A Yes.
530
531 Q Okay. And so eventually you and (Altick) deploy 21 gas rounds into – or
532 attempt 21 into the number two side.
533
534 A Correct.
535

536 Q Okay and from best of your knowledge, you get seven through the window,
537 you guys?
538
539 A We saw seven of them hit the window.
540
541 Q Okay. What did you guys do after you concluded – or why did you guys
542 conclude shooting into this side?
543
544 A They – it was my understanding that the Sheriff's Department was out of 37
545 mm or were running low. Um, they had a good position here, and so they
546 wanted us to move to the number three side so we could contaminate uh, we
547 had two windows – this one there's a window here – can I draw on this?
548
549 Q Yeah.
550
551 A There is a window here. See window A?
552
553 Q On the three side there?
554
555 A On the three side. Um, close to the three-four corner. There was another
556 window somewhere around here uh, window B that looked like it was covered
557 in wood and then there was the back door uh, somewhere over this way.
558
559 Q Okay.
560
561 A Um, so we-we left uh, (Mike Johnson) and I think (Gary Cooper) in position
562 here.
563
564 Q On the two side.
565
566 A Um, on the two sides cover then there's also at least – I think there was one of
567 the Sheriff's Department snipers also covering the two side and the door on
568 the one side – it was my understanding. Um, so we moved, went back up the
569 hill and then came back down into position behind the team that was up here.
570 Um, I was estimating that range at about 70-75 yards.
571
572 Q Okay. The team, what guys were those? Not you guys (unintelligible).
573
574 A There was – I know (Rico Sanchez) was one of them. They were positioned
575 about I'd say – I think it was that same position they were in in the morning.
576 They had gone back to – there was three people, I think two (SO) guys and
577 (Sanchez).
578
579 Q Okay.
580

581 A I'm guessing them to be about 35 yards out, ish.
582
583 Q Okay.
584
585 A Um, we were up hill and behind them a little bit to their right.
586
587 Q Okay.
588
589 A Um, trying to find something for cover, but there really wasn't much of
590 anything. Um, and like I said, I guessed that range at about 70-75 yards and
591 over here we had uh, (Todd Wilcox) was behind us a little bit using a tree for
592 cover and acting as our lethal cover and (Greg Hill) had come with us to our
593 position uh, acting as our lethal cover.
594
595 Q Okay and was -- did you guys deploy any gas on the number three side?
596
597 A Yes.
598
599 Q Okay and how were you advised to do that?
600
601 A Sergeant (Nova) I believe was called for a steady pace -- evenly paced um,
602 bole of four rounds.
603
604 Q Okay.
605
606 A Into the number three side.
607
608 Q Okay.
609
610 A And ...
611
612 Q Did you and (Altick) alternate again?
613
614 A No um, since it was only four rounds um, I held lethal cover with my rifle and
615 uh, let (Altick) do the gas delivery.
616
617 Q Okay and how-how did (Altick) go about deploying the gas in the number
618 three side?
619
620 A He put -- he fired a total of five rounds um, one of them hit the wall here.
621
622 Q By the A window.
623
624 A Yeah right between the A window and the three-four corner I believe it was.
625

626 Q Okay.
627
628 A Um and then he-he got two into A and two into B. It looked like they went
629 clear through B cause it looked like that was wood or something over that
630 window -- several pieces of wood, but it looked like it was putting holes in it
631 so from where we were, it looked like they had gone through it.
632
633 Q Okay.
634
635 A Whether they stuck into something on the inside is what I don't know.
636
637 Q Okay. And was there any other gas introduced at that point by either of you
638 after that?
639
640 A No not from that position.
641
642 Q Okay did you move to another position and was there any then?
643
644 A No.
645
646 Q Okay. Um, what-what-what happened after that gas was deployed?
647
648 A After that gas was deployed, again negotiations uh, were attempted um, then
649 the Sheriff's Department uh, came up with a plan to approach the building
650 um, under the cover of a ballistics blanket and they delivered uh, they
651 delivered gas into each window I believe it was. Yeah. They hand delivered
652 gas into the -- into each window. And they did that -- they did that I think
653 they picked up negotiations again and then they did that same attempt and
654 then picked up negotiations or attempted negotiations anyway.
655
656 Q What do you mean the same attempt?
657
658 A Uh, the same plan, walking up and hand delivering.
659
660 Q They did it twice then?
661
662 A They did it twice.
663
664 Q Okay. So was there a canister put in A one time, B one time, then again later
665 A again and B again, as far as you know?
666
667 A Yes.
668
669 Q Okay.
670

- 671 A That was—that was uh, listening to them talk and uh, I saw them approach
672 twice and um, cause the first time they did that uh, we were watching through
673 uh, the A window on three side um, after they deployed gas into B window on
674 four side and to me I didn't see anything disburse, so I was kind of wondering
675 if-if it uh, had even gone off, if the canister had even gone off. Um, but they
676 reported that it had so.
- 677
- 678 Q Okay. And then after they return here, what-what occurs next?
- 679
- 680 A Um, again negotiations attempted um, (unintelligible).
- 681
- 682 Q Okay. Um, at some time is there uh, smoke scene or is there more things
683 deployed? How – what-what goes on?
- 684
- 685 A They did the first deployment and they backed out, picked up negotiations.
686 Then they made another deployment, same thing behind the ballistic blanket
687 um, and listening to the radio traffic, it was my understanding they were
688 introducing a canister with uh, containing smoke and (CS) gas. Um, which to
689 me it obviously looked like – it looked like it had put out a lot more volume
690 than the original ones because we could actually see it. We could see you
691 know, you could see smoke coming out the windows and um, I think they also
692 introduced some sting ball grenades and I don't know as far as those – I don't
693 know how many or which windows, but that's what I heard on the radio.
- 694
- 695 Q Okay. So pretty much from-from those points, y-your – you guys stay here
696 and don't move anymore?
- 697
- 698 A Correct.
- 699
- 700 Q And eventually besides the-the smoke from the canisters uh, do you see uh,
701 other smoke coming from the house?
- 702
- 703 A Yes, several minutes after the-after the uh, the-the second delivery, we saw
704 um, cause the-the (CS) in smoke canisters put out a pretty white-white smoke
705 uh, then we started seeing some black smoke.
- 706
- 707 Q From what?
- 708
- 709 A I couldn't tell which window really it was coming out of cause we were back
710 up here, so I didn't have a view of this side, but it was coming out of this end
711 of the building.
- 712
- 713 Q Okay.
- 714
- 715 A Um.

716
717 Q Was there more negotiations or not negotiations with – was there any attempt
718 to negotiate still going on?
719
720 A Um, yeah, pretty much ...
721
722 Q The whole rest of the time?
723
724 A Continual, yeah.
725
726 Q Okay. So do you hear anything inside or anything like that?
727
728 A Um, I had-I had an earplug in my left ear. Um, I didn't put one in my right
729 ear cause I want to be able to hear my radio and you know, I had a 37 mm gas
730 gun going off by my right ear that was unplugged um, that was both up on the
731 two side and the three side so you know, at that point, my hearing was kind of
732 shot for the day. I couldn't hear you know, as far as like you know, if there
733 were anybody you know, yelling out the window, I-I couldn't hear anything
734 um.
735
736 Q Let-let me ask you this.
737
738 A I couldn't hear (unintelligible).
739
740 Q From this location over here at two and three and then-then attempts for the
741 negotiation or to the surrender orders um, could you hear them yelling those
742 out?
743
744 A I could. Over the PA, yeah.
745
746 Q And was it clear to you?
747
748 A Very clear.
749
750 Q Okay. As you well know, eventually the house catches on fire.
751
752 A Yes.
753
754 Q And that was-that was some time that went by, by the time it was smoldering
755 to the time it was actually engulfed?
756
757 A By the time we actually saw flames um, there was quite a long time actually I
758 was surprised with the way the black smoke-the black smoke that we saw and
759 the way it was coming out, I was surprised that it actually took that long
760 before I saw flames.

761
762 Q Okay. Earlier when me and Steve met with you-you gave us a 37 mm round.
763
764 A Yes.
765
766 Q And that's the kind that you had deployed, you and (Altick)?
767
768 A Yes.
769
770 Q Okay. Um, explain that round to us a little.
771
772 A It um, its all plastic. Um, inside there's a plastic canister for a lack of a better
773 word – container – and when you fire it, that white casing, the white plastic
774 shell stays in the gun and the blue – the part that you saw with the blue end –
775 um, that um, is projected out of the weapon and that's what actually impacts.
776 Inside there um, the ones we have, I believe are -- everything that we have
777 that we deploy is uh, out of that is (CS). Um, and I think the ones that we
778 have are liquid inside so when it hits it breaks apart and splatters, disburses
779 particles into the air.
780
781 Q Okay. Are those def tech rounds?
782
783 A Yes, they are made by defensive technologies.
784
785 Q Okay. I'm not too familiar with this stinkball thing grenade. What-what is
786 that?
787
788 A It's uh, we don't actually have any. Um, it's for riot control, crowd control,
789 they use them in prisons and uh, jail settings and what not for riots, but my
790 understanding of it is – I've never actually deployed one, but it's a rubber
791 housed uh, about the size of a softball, rubber housed, kind of grenade for a
792 lack of a better word, but inside um, it has lots of little rubber balls, maybe ½
793 inch rubber balls, 3/8 of an inch um, and when it's-when it's deployed um, it
794 has same you know, similar fuse mechanism as uh, like a (OC) or a (CS)
795 canister um, but it ruptures and then scatters those plastic – or the rubber balls
796 as uh, (unintelligible).
797
798 Q Okay.
799
800 A Um, but it-it scatters and I don't know how many are in there – it scatters
801 those you know, throughout a given area.
802
803 Q Okay.
804

805 A It was my impression that um, due to the uh, due to the danger of actually
806 having to walk up to the building to deploy the canisters um, my impression
807 of it was that they would – that they'd deploy those first to uh, maybe clear
808 out the room where they were deploying the gas or to back somebody away
809 from the window.
810
811 Q Okay.
812
813 A So that you know, to prevent an ambush.
814
815 Q Okay.
816
817 A To protect themselves.
818
819 Q And what about the-the smoke (CS), how-how does that go – how does that
820 work?
821
822 A Um, you know I've never-I've never deployed that. I've deployed smoke and
823 (CS) independently of each other, but I've never deployed a smoke/(CS)
824 canister.
825
826 Q Okay.
827
828 A Um, so I'm not entirely sure how it works. We don't have that.
829
830 Q Um, while you're out there, did you hear any talk about pyrotechnics or
831 anything like that?
832
833 A Yeah um, Sergeant (Nova) asked us if we had any pyrotechnics with us. Um,
834 and we don't. We didn't-we didn't have any with us.
835
836 Q You guys carry any of those at all?
837
838 A Um, we carry just a very few of the small uh, little pocket (CS) canisters they
839 are pyrotechnic. Um, but they're very small and they're about that big. Um,
840 and that's like you know, for access denial or you know things like that but
841 um, that's – I believe that's the – we have heavy barricade penetrating
842 projectiles for the 37 mm um, which can penetrate thicker you know, heavier
843 objects than what – like the one I gave you does.
844
845 Q Uh-huh.
846
847 A Um, and it, it burns and creates a smoke, but it burns inside a capsule, so
848 there's no exposed flames, it gets hot, but it doesn't actually expose flames

849 out into the environment um, but it-it does burn inside the capsule that's
850 projected.

851
852 Q Okay.

853
854 A But those are – that would be about the only thing close to pyrotechnics that
855 we had out there.

856
857 Q Okay and as far as you know, nothing like that was ever discharged into the
858 house?

859
860 A It was my understanding that they used um, something similar like a flameless
861 expulsion. Like similar to that heavy barricade projectile and they burn
862 inside, but doesn't expose flames.

863
864 Q It just gets real hot.

865
866 A Yeah. For something happening like smoke.

867
868 Q Right.

869
870 A I mean something has to burn in order for it to make smoke so um, that's my
871 understanding of it. So it'll get hot, but it's not uh, like some of the crowd
872 control like they are designed to not be picked back up. Um, they don't uh, --
873 my understanding is that they don't uh, expel flames like those do.

874
875 Q Okay. And um, was your experiences been um, between of gas and stuff I
876 mean how – with the range you guys were at and the amount of gas that you
877 feel got into that house, what do you think the effective level was on someone
878 that was in there?

879
880 A With the amount of gas that we were actually able to deploy into the two side
881 uh, after finding out that some of those rounds actually impacted the side of
882 the house but didn't break and watching them fly um, the ones that I would
883 say probably very few that broke – you know very few that actually went
884 through the window, I would-I wouldn't be surprised if very few of them
885 actually broke and disbursed the agent. Some of them seemed like they-like
886 they went – they you know they flew straight, they flew hard and they hit
887 where they needed to go and so I was confident that you know some of them
888 did-did break and would have contaminated the area.

889
890 Q So just because one of the rounds goes through the window, it doesn't mean
891 it's going to break open then?
892

893 A Right. If it – because you know, they were impacting the side of the house,
894 which is quite hard, and not breaking, so if they hit a window that's obviously
895 not as hard as the wood...
896
897 Q Is that because of the range you guys are shooting it from?
898
899 A Yeah, yeah.
900
901 Q Okay.
902
903 A Cause they lose a lot of energy at that point. Cause I was having to aim um, I
904 was having to aim a foot or two high above the window and a foot or two to
905 the right with the wind to get them in – get them even close to the window.
906
907 Q Okay.
908
909 A Um, so they've lost a lot of energy at that point. Um, if they go through the
910 window – probably the window is not enough to break it and then it lands on a
911 bed or piled clothes or soft carpet, there's a very good -- especially at the
912 angle you know, we are shooting down into it uh, very good chance that
913 they're not going to break. Um, but if they do break, it doesn't take a whole
914 lot to contaminate – you know, if you do actually get some to break, you can
915 contaminate you know, an average room with a couple of them.
916
917 Q So they're over all, they're not that-that strong then really?
918
919 A Um, it-it's been my experience um, this was my third gas deployment um, an
920 actual operational gas deployment um, and it has been my experience that
921 with the other two – both of the other stuff (unintelligible) were able to fight
922 through it. Um, there's measures you can take to defeat it or to delay the –
923 you know to delay the ...
924
925 Q What do you mean (unintelligible)?
926
927 A Um, an easy way uh, typically one of the first places if you can identify where
928 it is you want to deny the bathroom. Um, you can fill the bathtub up with
929 water, lay down in it, cover your face and just breathe you know, or put a wet
930 towel over your face so you act more or less as a particulate filter cause that's
931 all it is is just a particulate.
932
933 Q Mm-hm.
934
935 A Um, water is by far the best way to defeat it. Um, it has been my experience
936 with some of the other uh, with my last deployment um, that uh, the [REDACTED]
937 was able to defeat it by creating a tent um, with bed sheets I think is what

938 happened. Um he hid under the bed, under the tent, agents were disbursed to
939 try to aim high so they'd break up above and float down um, he was able to at
940 least defeat some of the effects of it uh, by hiding under the tent. He also
941 blocked the bathroom door were we delivered – so he denied the bathroom so
942 he blocked the door. Shut the door, stuffed a sheet or something under it and
943 then turned on the fan and vented it out.

944
945 Q When you say stuff sheets, like around the bottom...

946
947 A Underneath the door to keep the stuff from coming out.

948
949 Q Okay.

950
951 A Um and it was my understanding that that [REDACTED] uh, not the one in (Pupa)
952 but the one I was referring to was under the influence of drugs too so you
953 know, probably not feeling the pain uh, able to fight through the pain a little
954 bit better more than a sober person would.

955
956 Q Okay. And Tim, in-in your opinion, I mean how-how would you say um, the
957 fire at that house would've-would've started?

958
959 A I honestly can't say. I-I don't know if it was deliberately set or uh, by the
960 [REDACTED] or um, cause certainly he had plenty of opportunities to give up um, it
961 was obviously very clear that um, he wouldn't be harmed if he came out and
962 followed directions um, even though what he had done, it was very clear that
963 if he came out and followed directions, no harm was going to come to him.

964
965 Q And he had – would you say even by the time you saw flames, would he have
966 had ample opportunity still to get out of that residence?

967
968 A I believe so. In fact while we were up here on the three side, as soon as we
969 saw the heavy black smoke and the flames, I fully expected him to probably
970 not come out the front door, but to come out this back door or out a window
971 maybe on the two side um, I fully expected um, him to exit out this back end
972 since it started here um, and we were always prepared for another gun fight.
973 Based on what he had done um, we put the gas stuff away and came up with
974 lethal cover and totally expected a firefight you know, expected him to come
975 out either one of these and very possibly uh, engage us with uh, firearms.

976
977 Q Okay.

978
979 A Based on what had happened so far.

980
981 Q And you were armed with your – what-what weapon did you have?
982

983 A Up here um, I was armed again with my (AR15) uh, my 308 was still -- was
984 back in the truck at that point.
985
986 Q Okay.
987
988 A Um and my handgun.
989
990 Q Okay.
991
992 Q1 Just a couple of things, how many total rounds did (EPD) deploy?
993
994 A 26. That's the round count that I got from (Altick).
995
996 Q1 And that includes both the number two and three sides?
997
998 A Two and three. Yes, two and three. We had uh, (Luis) count up 21 from the
999 two side and five on the three side, four of which looked like they went in. I
1000 know if they hit the windows anyway.
1001
1002 Q1 And were you and (Altick) the only personnel from (Eureka) Police
1003 Department to deploy any gas?
1004
1005 A Yes.
1006
1007 Q1 And you're the two for the SWAT Team -- you're the two that are trained to
1008 deploy this?
1009
1010 A Um, Officer uh, (Marsh) um, -- (Luis) is a patrol rifleman, so is Officer
1011 (Marsh) um, we weren't able to get contact with Officer (Marsh) so he wasn't
1012 deployed with us. So um, (Luis) and (Marsh) are the chemical agents
1013 deployment officers. I was until they took over um, so in order to fill in and
1014 supplement (Altick) I-I backed him up.
1015
1016 Q1 Okay. And what-what type of training do you guys have to go in order to be a
1017 gas person for the SWAT Team?
1018
1019 A Mine was a week long, a 40-hour course um, provided at Napa Valley
1020 College. Um, back in 2000 I think it was that covered um, the different types
1021 of munitions, case law um, some delivery techniques, some exposure to some
1022 of the weapons or some of the munitions.
1023
1024 Q1 And do you guys during SWAT training, do you guys train with gas?
1025
1026 A Yes.
1027

1028 Q1 Say how often do you do that? I mean?
1029
1030 A At least annually when we uh, uh, you know we do drills with uh, masking,
1031 unmasking um, exposure contamination, mask clearing um, working in a
1032 contaminated environment and typically that's about once a year.
1033
1034 Q1 And you also said that this was the third time you've deployed gas?
1035
1036 A Yes.
1037
1038 Q1 On the first two occasions where you deployed gas um, without going into a
1039 lot of detail um, how were those deployed? Where they deployed through a
1040 window, a wall, into a bedroom setting, into a vehicle, what type of setting
1041 was that briefly?
1042
1043 A Um, the first one was a residence – a residential setting.
1044
1045 Q1 Okay.
1046
1047 A Um, deployed through windows with 37 mm and 12 gauge. Um, and the
1048 second time was into a motel room setting deployed with 37 mm only.
1049
1050 Q1 And do you – ballpark uh, remember how many rounds might have been fired
1051 into those situations?
1052
1053 A The first one was somewhere between uh, from the 37 was somewhere
1054 between 17 and 20. Um, cause we had a lot of different places to contaminate
1055 and deny um, and then somewhere in the vicinity of 40 rounds of 12 gauge.
1056 Uh, cause they're pretty small and then the motel setting uh, 14 total. Four of
1057 which failed to penetrate the black out curtain and at least one or two failed to
1058 penetrate the wall cause I hit studs or uh, other wall.
1059
1060 Q1 And on those did you have any problems with uh, structures catching on fire
1061 because of any rounds used?
1062
1063 A No.
1064
1065 Q One more thing, did you guys – did you or (Altick) pick up the rounds the
1066 extended rounds?
1067
1068 A I think uh, I think Sergeant (Johnson) picked one up from the two side um,
1069 because he had it over here at the three side.
70
1070 Q Okay.
1071
1072

1073 A And I was told they found 20 over here.
1074
1075 Q Okay.
1076
1077 A And (Luis) counted up 21 um, but then Sergeant (Johnson) had one uh, after
1078 we backed out, after the fire started um, and there was a concern about a
1079 propane – a couple propane tanks we backed out and then at some point later
1080 he had one.
1081
1082 Q Okay.
1083
1084 A But it was my understanding that he picked it up from where he was
1085 positioned at the two side.
1086
1087 Q Okay. Did he keep that or did he place it somewhere?
1088
1089 A I don't know.
1090
1091 Q Okay. Um, throughout our conversation with you, you've been referring to
1092 this diagram that we had one of our investigators draw.
1093
1094 A Mm-hm.
1095
1096 Q1 Um, is that -- I mean obviously it's not to scale or anything, is that fairly
1097 accurate or depict kind of the-the scene?
1098
1099 A It looks to be yeah. I never did have observations on the one side so as far as
1100 how this is laid out I don't know. The only sides that I had were the two,
1101 three, and four sides.
1102
1103 Q1 Okay.
1104
1105 A But um, both sides that I saw uh, appear to be accurate.
1106
1107 Q1 Okay. If you don't mind, at some point I'll sign that with you.
1108
1109 A Okay.
1110
1111 Q1 And we'll just attach that so we have reference to anything on that. I don't
1112 have anything else.
1113
1114 Q No I don't either. End at 1039.

1117 This transcript has been reviewed with the audio recording submitted and it is an accurate
1118 transcription.
1119 Signed _____

1
2
3
4
5
6
7
8
9
10
11
12
13
14
15
16
17
18
19
20
21
22
23
24
25
26
27
28
29
30
31
32
33
34
35
36
37
38
39
40
41
42
43
44
45

INTERVIEW WITH TONY GOMES

Q=Det. Rich Schlesiger

Q1=Inv. Steve Dunn

Q2=[REDACTED]

A=Tony Gomes

Q: Okay. Date is June 6, 2007. Time is 15:48 hours. Case 200703162. Um, we're at the Humboldt County Sheriff's Office in the conference room. Um, present is Detective Schlesiger, Investigator Dunn, ah, Deputy Tony Gomes and his representation, [REDACTED] Um, Tony, you know why we're here to talk to you and all that. I mean I - I talked to (Brian) a little out there, and he - obviously some shots were fired towards you guys, and he told me that you were one of the people that had shot back.

A: Yeah.

Q: Okay. Um, and you're here to give a voluntary statement about what had occurred.

A: Yes.

Q: Okay. Um, Tony Gomes - what's your PIN?

A: 1360.

Q: Okay. And, um, how long you been workin' for us now?

A: Um, two years corrections and two and a half years on patrol.

Q: Okay. And you're a member of, ah, our SWAT team?

A: Yes.

Q: Or SET team. Um, how long you been doin' that for now?

A: Um, couple months.

Q: Okay. And did you go to any training to become a member of that?

46
47 A: A two week basic SWAT school.
48
49 Q: Okay. Um, o – on – on the SET team what is – is, um – do you have a – a
50 specialty or – or anything like that?
51
52 A: I don't have anything really special position.
53
54 Q: You're a general member. You're not a sniper or somethin' like that.
55
56 A: No.
57
58 Q: Okay. Um, Tony, ah, going back to June 3rd, um, how – how were you
59 notified of what was occurring?
60
61 A: I, ah, received a page on my department issued pager...
62
63 Q: Okay.
64
65 A: ...for a SET team call out.
66
67 Q: Okay. And did you call Dispatch?
68
69 A: I called Dispatch, um, told us where camo, meet at the office, and we were
70 gonna respond to the [REDACTED] in Hoopa.
71
72 Q: Okay. So eventually you meet here with the other members of the team?
73
74 A: Yeah.
75
76 Q: Okay. Were you – were you briefed here at the Sheriff's office?
77
78 A: Ah, we were briefed a little bit at the Sheriff's office.
79
80 Q: And what were you told?
81
82 A: Um, that some officers and deputies went to do a welfare check in Hoopa.
83 Um, and they had a picture of a guy, ([REDACTED]) I think was his name and
84 said that he had pointed firearms at them and pretty much barricaded himself
85 in the house that it was on.
86
87 Q: Okay. And, ah, I don't have a good recollection of the times, but do you
88 know what time about you guys left the office?
89
90 A: Um, I wanna say probably around 5 pm...

91
92 Q: Okay.
93
94 A: ...5:30 maybe.
95
96 Q: So you guys responded, um, I believe it's Bloody Camp Road is what the --
97 the road is where the residence is located.
98
99 A: Yeah. I just knew it was Pine Creek -- off of Pine Creek.
100
101 Q: Yeah. Okay.
102
103 A: Yeah, 'cuz we did take a right off of Pine Creek...
104
105 Q: Okay.
106
107 A: ...where we parked.
108
109 Q: And, um, when you guys arrived, which I believe was around probably
110 16:30...
111
112 A: Um, at a little sooner than that, 18:30?
113
114 Q: Or 18:30, sorry.
115
116 A: Yeah, I think it was right around there.
117
118 Q: Okay. When you arrived, who -- who'd you ride up with?
119
120 A: Ah, (Todd Pullman).
121
122 Q: Okay. When -- when you guys arrived, ah, what happened, ah, once you guys
123 arrived?
124
125 A: Ah, once we were still driving up almost to the driveway of the residence, and
126 we heard on the radio that shots were fired, shots were fired. And I believe it
127 was (Cornell) requested we expedite because we were pulling the SET trailer
128 and had everybody's gear...
129
130 Q: Okay.
131
132 A: ...with us.
133
134 Q: Okay. And you guys did so and went down and -- and where'd you guys, ah,
135 park or stage at?

136
137 A: Ah, we pulled down the road and there was a couple of HSO vehicles in front
138 of us. And we pulled down as close as we could to their cars.
139
140 Q: Okay. And what'd you guys do after that?
141
142 A: Um, we got out, um, and (Pine) told us get your stuff, get your gear. And we
143 started – we got geared up and (Brian) told us that shots were fired. And we
144 went down to, ah, two Hoopa cars.
145
146 Q: And (Brian) is a team leader for the SET team?
147
148 A: Yeah.
149
150 Q: Okay. And so you went down to the two Hoopa cars. Did you notice
151 anything about the two Hoopa cars?
152
153 A: Ah, there was multiples in the windshields.
154
155 Q: Okay. Did anybody tell you what had happened?
156
157 A: Yeah. I don't remember who exactly. Um, (Brian Taylor) was on the driver's
158 side of the first, um, Hoopa car. And I think he's the one that told me that,
159 um, the [REDACTED] opened the window in the (4A) corner, the southwest corner,
160 and put a barrel out the window and fired multiple shots.
161
162 Q: Okay. Before we go any further then, I would – we did a little sketch here, so
163 you can draw on it or do whatever. And, you know, we'll just have you sign
164 your name down there. Is – is this – it's not the best drawing – but is this
165 somewhat...?
166
167 A: It's pretty – pretty close though, yeah.
168
169 Q: And I understand there's probably other vehicles here...
170
171 A: Yeah.
172
173 Q: ...back in here.
174
175 A: There was a couple – this was – all the patrol cars passed us 'cuz we're pullin'
176 the trailer. We were a little slow. But I think there was maybe – maybe at
177 least two HSO cars here and we pulled in right behind them.
178
179 Q: Okay. And they're the two, ah, Tribal (unintelligible)...
180

- 181 A: Yeah.
- 182
- 183 Q: And those were the ones that had the windshield (unintelligible)?
- 184
- 185 A: Yes. I think the first had – looked like two holes in the windshield, and the
- 186 back one had one about in the center of the windshield.
- 187
- 188 Q: Okay. When you went up to those vehicles, who – who was – who was
- 189 present? You said (Brian Taylor) and who else?
- 190
- 191 A: Um, I believe it was, um, (Spellino) from Hoopa Tribal was behind the first,
- 192 um, SUV right here. And (Brian Taylor) was still at the driver's side door.
- 193 And I can't remember if anyone else was there or how many other people.
- 194
- 195 Q: You mentioned (Brian Quenelles). Wa – was he down there with you guys
- 196 (unintelligible)?
- 197
- 198 A: Yeah, he – he went down – well he came up when we first – when we got
- 199 here, um, I remember (Jessie Taylor) and (Brian) comin' up and meeting us at
- 200 the trailer telling us that there was shots fired. And then other people were
- 201 comin' up to get their gear. And then, ah, (Brian) had, ah, myself, (Brian) Ta
- 202 – or excuse me, (Brian Quenelle) – um, I guess I should be usin' the last
- 203 names since there's two (Brians) on the team – um, (Quenelle) had myself;
- 204 (Jamie Barnie), and (Jessie Taylor), us four went down to the first, ah, Hoopa
- 205 SUV.
- 206
- 207 Q: Okay. And, um, as far as when – goin' back a little, you went and got your
- 208 equipment. Were you dressed in your full SWAT outfit, the vest, helmet?
- 209
- 210 A: Not when I first showed up.
- 211
- 212 Q: Not when you first showed up, but eventually.
- 213
- 214 A: Yeah, helmet, gloves, vest, ah, duty belt with a handgun on the side.
- 215
- 216 Q: Okay.
- 217
- 218 A: (Unintelligible)
- 219
- 220 Q: And then, um, does anybody mention when they get down here, when the
- 221 shots were fired at the Tribal units, did anybody return fire?
- 222
- 223 A: Um, yeah. Um, (Brian Taylor) shot once.
- 224
- 225 Q: Okay. And, um, what did you guys do next after that?

226
227 A: Um, we took positions of cover and – and covered the house basically.
228
229 Q: Okay.
230
231 A: Got it contained.
232
233 Q: Still down there at that location?
234
235 A: Yes, still right here.
236
237 Q: Okay. Did you know if there were any other cops or anything like that ar –
238 around that weren't in this general area?
239
240 A: Ah, I knew there was – I – I knew we had a – a decent perimeter on it. I knew
241 there was, um, I think, um, (Barry) was up there somewhere, um, a Yurok
242 officer, and maybe another Hoopa guy. I just – I knew there was other people
243 that were around the house.
244
245 Q: There's other patrolmen around the house?
246
247 A: Yes.
248
249 Q: Okay. Um, what went on after that?
250
251 A: Um, we covered the house and they had the negotiators come down to the
252 second Hoopa car to start negotiations.
253
254 Q: Okay. And did they begin that?
255
256 A: Yes.
257
258 Q: Okay. How long would you say that was at until after you had ri – arrived?
259
260 A: Um, time is really hard. Ah, it didn't seem like it was very long.
261
262 Q: Okay.
263
264 A: Um, half hour maybe.
265
266 Q: Okay. And, um, down here at the cars where – where were you mainly at?
267
268 A: Um, the – both doors were open on the Expedition and I...
269
270 Q: The front one?

271
272 A: Yeah. And I was on the passenger side right behind the passenger front door.
273
274 Q: Okay. Um, did you have any of your weapons drawn at that time?
275
276 A: Yes.
277
278 Q: What did you have?
279
280 A: Ah, my Colt M1682.
281
282 Q: Okay. And were – did you have your handgun and magazine belt still on you?
283
284 A: Yes, they were on me. They were...
285
286 Q: Holstered?
287
288 A: ...holstered.
289
290 Q: Okay. And, ah, when you – were – were you covering the house with – with
291 your rifle pointed, or did you have it slung? How – how were you doing that?
292
293 A: I had, um – actually had – they had brought down some ballistic shields. And
294 I was kind of half sitting in the passenger seat. And I put the ballistic shield
295 kind of half onto the floorboard and took the strap off and tied it to the handle
296 on the inside of the car so it would stay there. So it's kind of half in the car,
297 half out of the car. And I had my, ah, rifle resting on top of the – on top of the
298 ballistic shield in between the door posts kind of – or the frame post of the car
299 and the door...
300
301 Q: Okay.
302
303 A: ...in the little V there.
304
305 Q: Okay.
306
307 A: I was covering the house.
308
309 Q: Tony, while you were down there at the – and – and observing the house, did
310 you see or hear anything?
311
312 A: Um, during the time, ah, there was times when I could see him in the 4A but
313 not – you could see a hand, an arm, um, some yelling, hollering. Ah, at one
314 point I heard him say come get some, fuckers. And that was about it. There
315 wasn't a whole lot. You can hear some bangin' around, but not a whole lot of

316 communication from him, no actual words or nothin' except, ah – and later on
317 I heard him talkin' about grenades or sa – I mean he was makin' some stuff
318 that really wasn't making a lot of sense.

319
320 Q: Okay. And, um, the attempts to negotiate with him, could – could you hear
321 those fine and everything from the PA?

322
323 A: Yeah, I could hear him fine.

324
325 Q: That would have been right behind you, right?

326
327 A: Yeah.

328
329 Q: Okay. And, um, was there any response from the man that was inside of here,
330 (Peter), from the house?

331
332 A: I couldn't tell. You know, he'd hoot and holler every once in a while, but I
333 don't know if he was tryin' to talk to the negotiators or acknowledging them
334 or not. I couldn't tell what he...

335
336 Q: Okay. And – and who – so were you taking direction from Sergeant
337 (Quenelle) at that time?

338
339 A: Yes.

340
341 Q: Um, did you guys ever move from this location?

342
343 A: Um, not until – I never moved from this car until, um, EPD SWAT teams
344 were leaving.

345
346 Q: Okay.

347
348 A: And that was 4 o'clock in the morning or something like that.

349
350 Q: Okay. So you were mainly stationed at the...

351
352 A: I was stationed there, yes.

353
354 Q: Okay. As time goes on, does somethin' happen?

355
356 A: Yeah, at about, um, 8:30, 9:00 maybe – it was still pretty di – daylight out – I
357 saw some kind of object come out of the window, push the window open.

358
359 Q: Which window?

360

361 A: The 4A.
362
363 Q: Okay.
364
365 A: Um, I saw it push the window all the way open. I told everybody he's
366 opening the window, he's opening the window. Um, I was, ah, aiming my –
367 my rifle at the window. I couldn't see what it was. Ah, I couldn't even see
368 him. Ah, and the next thing I heard was a gunshot and felt the bullet hit the
369 car that I was in. Um, I mean I felt the concussion. And I ducked down
370 behind, ah, the ballistic shield. And I didn't hear another shot. So I came up
371 and got a site picture on the window, and I fired two quick shots into the 4A
372 window.
373
374 Q: Okay. Could you see anybody in the window when – when you fired at that
375 time?
376
377 A: No.
378
379 Q: Okay. Um, when you fired the two – the two rounds into the 4A window, did
380 anybody else fire that you know of?
381
382 A: Ah, yeah, I heard a few more shots when – during – when I shot.
383
384 Q: Later on did you find out who had – who had shot?
385
386 A: Yeah, later on I heard that Sergeant (Quenelle) had fired two rounds, and, ah,
387 (Barnie) had fired two rounds.
388
389 Q: Okay. At that time when that happened, Tony, will you like put your – your
390 initials, (Quenelle)'s initials, and (Barnie)'s initials, and maybe whoever else
391 you know that was around?
392
393 A: Um, I don't know where these guys were. I just knew (Jamie) was on...
394
395 Q: Okay.
396
397 A: I'm pretty sure (Jamie) was over here. But the way the car – and I'm lookin'
398 off here – I couldn't pick him up in my peripheral. But I'm pretty sure that
399 (Jamie) was at this door. Um, I think (Jessie Taylor) was back here
400 somewhere, (Brian Quenelle), and, ah, maybe (Clayton Sorrow).
401
402 Q: Okay.
403
404 A: And (Sorrow) showed up I don't know what time. He got there late. He was
405 coming back from running. I can't remember...

406
407 Q: Okay.
408
409 A: ...if he was there or not. But I know we had – usually on this side we had –
410 um, there was at least two guys up here, one behind the other person...
411
412 Q: On the driver's side?
413
414 A: ...on the driver's side to help this guy with coverage. But up here there was a
415 big bush right here. And havin' a guy here, you can't see nothin', so it didn't
416 do any good. So we were only havin' one guy on that side.
417
418 Q: Okay. Tony, from – from your viewpoint here, how good of – of view of the
419 number four side or any part of the house did you have?
420
421 A: I could see, um, this whole side and about halfway down this side.
422
423 Q: So the whole thing on number four and about half in...
424
425 A: Yeah, there was a bush that kind of covered a little bit of the bottom of the –
426 the B window. But everything else – the house sat up on the hill – I can see
427 pretty – pretty good.
428
429 Q: You said you felt the – the shot come and hit the vehicle. Did – did you have
430 any idea where it did hit?
431
432 A: I didn't. I just knew it was close...
433
434 Q: Okay.
435
436 A: ...'cuz I felt like it – like a small concussion like where it hit. And I didn't
437 find out 'til later.
438
439 Q: Okay. Um, so you guys continue to stay there. Um, what – what happened
440 with the negotiation attempts after that – that shot was fired? I mean let me
441 back up. Was there only one shot that you know of from the [REDACTED]
442
443 A: Um, when I was there, yes. I mean the shots before I got there. But as far as I
444 know, there was only one shot.
445
446 Q: Okay, okay. And, um, from what I understand, what about after – after the
447 shot occurs anything goin' on in the house?
448
449 A: After – after we fired into the house we could hear – I heard him running – it
450 sounded like he was running through the house to the back. And you can hear

451 stuff crashin' and big loud thuds like he fell down, or dropped somethin', or
452 knocked somethin' over, and some screamin' and hollerin'. And then it
453 stopped.

454

455 Q: Okay. Um, so you guys -- do you guys mainly stay at that position until EPD
456 relieves you?

457

458 A: Yes.

459

460 Q: Pretty much all you guys?

461

462 A: All of us, yeah.

463

464 Q: What -- did you guys become a team at any point at that location, or was that
465 pretty much...

466

467 A: Yes, we were pretty much, ah, team one I believe.

468

469 Q: Okay. Now from what I understand, did -- were patrol guys eventually
470 relieved of their location (unintelligible) around the perimeter?

471

472 A: Yes.

473

474 Q: Do you know when that occurred?

475

476 A: Um, I believe it occurred in the first -- it was...

477

478 Q: Was it before or after he shot at you?

479

480 A: It was -- they were lead before he shot. And they were (unintelligible)...

481

482 Q: Okay. Do you know any of these guys that went out to the perimeter?

483

484 A: Yeah.

485

486 Q: Who was that?

487

488 A: Um, I know we sent two snipers up to the number three side, one about in here
489 and one covering the two side, which was (Ireland) and (Bishop). Um, I
490 believe (Garcia) was team two, and he took, um, (Brian Taylor), (Bolton),
491 (Lundee), and -- 'cuz I saw -- I think they went around. And then were cov --
492 on this road coverin' the number one and part of the number two sides.

493

494 Q: Okay. And, um, when – when you would – when you'd – you guys had shot
495 those rounds, were any of the shell casings or anything like that picked up or
496 anything?
497

498 A: Not to my knowledge – I didn't even look for 'em.
499

500 Q: Okay. And so you stay here until...
501

502 A: About 4 o'clock in the morning.
503

504 Q: Okay. And - and you are relieved by E...
505

506 A: EPD SWAT team.
507

508 Q: ...EPD SWAT team, okay. And did you go back and, um – to...
509

510 A: By then I believe the command post was back here...
511

512 Q: Yeah.
513

514 A: ...at the start (unintelligible)...
515

516 Q: Beginning to (unintelligible) now. And you – you guys went back there then
517 where...
518

519 A: Yes.
520

521 Q: Okay. Um, where'd you guys go after that?
522

523 A: We went down to the Hoopa substation.
524

525 Q: Okay. Ah, and – and at that point you guys were still considered in
526 operational mode in case somethin' occurred back here, which is, what, 10
527 minute driving, would you say, to get from the sub up there?
528

529 A: Yeah.
530

531 Q: Okay. Did, ah, you reload your weapon or anything at that time?
532

533 A: No.
534

535 Q: Okay. Um, what time – um, well by this time who else was on scene? W –
536 was there anyone – was your commander of the SWAT team there yet?
537

538 A: Yes.

539
540 Q: And who was that?
541
542 A: Lieutenant (Cavento).
543
544 Q: Okay. Um, you guys go back to the sub and probably try to get some rest.
545
546 A: Yeah, we were only there for a hour, maybe a hour and a half. By the time we
547 got somethin' to eat and everybody used the bathroom and then we started
548 talkin' about operation plan for when we came back and got that kind of – had
549 another little briefing about our operation plan, and then it was time to head
550 back up the hill.
551
552 Q: Okay. Um, when you guys headed – headed back, um, what time was that in
553 the morning? Can you recall?
554
555 A: I think we got back up there around 6:30 in the morning.
556
557 Q: Okay. So if you're relieved at 4, there wasn't much time.
558
559 A: No.
560
561 Q: Okay. Did you – and were you on your day off?
562
563 A: Um, what day was it?
564
565 Q: Sunday.
566
567 A: Sunday. Um, no, I worked, ah, graveyard the night before that.
568
569 Q: You worked graveyard? Okay. And you got the call. Were you sleeping at
570 that time?
571
572 A: No. Um, I went to bed at 600, 700 in the morning, and I woke up at, um, 3,
573 330 and got the page at 345, 400.
574
575 Q: Okay. So you got about eight, nine hours of sleep.
576
577 A: Yeah.
578
579 Q: Okay. Um, you guys come back up here. And, um, do you – are – are you
580 told by – who – who – what team leader were – was – were you assigned with
581 – (Brian)?
582
583 A: When we came back up the second time?

584
585 Q: Yeah, the second time.
586
587 A: Or, um, in the morning?
588
589 Q: I'm assuming it'd be (Brian) that was the first.
590
591 A: I was (Brian)'s here, and then I was assigned to Team Two, which was, ah,
592 Sergeant (Garcia).
593
594 Q: Okay. And obviously EPD SWAT was out there. Did you guys go and
595 relieve them at that time then?
596
597 A: Yes. We – well when we first got back, we were told to standby 'til about 8,
598 8:30, and then we went and relieved 'em.
599
600 Q: Okay. And you said you made – you guys had talked about some operational
601 plans. What – what – what was discussed?
602
603 A: Ah, introducing gas, um, who was on what team and their positions, and, um,
604 discussed where they were gonna put the gas into the house, which sides, and
605 we were gonna try to put the gas into the floor in three side and force them to
606 come out on the one or two side. And the Two Team was the arrest and react
607 team.
608
609 Q: Okay. And so when you roll out with Team Two, wh – where do you guys
610 head to?
611
612 A: Um, we come across the hill on the number three side, loop around the back
613 side of the house. And there was a Yurok car parked about 150 yards from
614 the house on this road. And we relieved two EPD officers there.
615
616 Q: Okay. Do you recall who was on Team Two at that time?
617
618 A: Um, it was...
619
620 Q: Well (Bishop).
621
622 A: I guess (Bishop) was part of our team. He was a sniper set up on the number
623 two side on the hill. And down here it was myself, Sergeant (Garcia), um,
624 (Fulton), and (Miller).
625
626 Q: Can you put their initials by this?
627
628 A: That's (Miller)'s first name.

629
630 Q: Okay.
631
632 A: (Bishop) was over here.
633
634 Q: Okay. And you guys kind of take cover around the vehicle (unintelligible)...
635
636 A: Yeah. We're -- we're there for quite a while. So, you know, one would be
637 here. One would be in the door. This is the passenger side, the only side we
638 can get a good visual of the house. So we were -- two guys would take naps or
639 rest for 15, 20 minutes, and we could flip flop it out.
640
641 Q: Okay. And, ah, while that's goin' on, what's goin' on around the house?
642
643 A: Um, it's quiet.
644
645 Q: Okay.
646
647 A: Um, I hear negotiators. I could hear the negotiators from over here. And I
648 believe they were at the second cars on the PA system.
649
650 Q: Ah, and as you said, the house is -- or the (Yurok) car is probably 150 yards.
651
652 A: A hundred fifty yards, yeah, to the northwest of the house.
653
654 Q: Okay.
655
656 A: And we can hear 'em negotiating, and I could hear 'em pretty clear.
657
658 Q: Okay. Um, so pretty much that whole -- this would be on the fours now,
659 right?
660
661 A: Yes.
662
663 Q: Um, nothin' goin' on around the house or anything like that.
664
665 A: No, not for a while.
666
667 Q: Do you ever move from this location?
668
669 A: No.
670
671 Q: Okay. Um, eventually do you ever hear anything about gas that's gonna be
672 introduced into the house?
673

674 A: I did.
675
676 Q: Okay. And who did that come from?
677
678 A: Um, I heard, um, Sergeant (Quenelle) and (Cavento) talkin' about it on the
679 (unintelligible) over the radio.
680
681 Q: Okay. And that was a few hours after you guys are there.
682
683 A: Yeah, we were there for – I – I think they – they must have negotiated for two,
684 three hours after we relieved EPD.
685
686 Q: Okay. And at that time was when you started hearing the talk.
687
688 A: The talk about gas.
689
690 Q: Okay. Um, what occurred after that?
691
692 A: Um, I know that, um, well they started introduc'in' gas from the I believe it's
693 the four and number three sides.
694
695 Q: And you're here the entire time, Tony. Do you ever see any of the – the team
696 members headin' up to the number four side, or are you guys too far back?
697
698 A: Um, I – at one point I saw a team come up to the 4A window using a – like a
699 ballistic blanket. And they had a long pole. And it looked like they put a –
700 some type of a gas into the window. And then...
701
702 Q: How – how did...
703
704 A: ...they backed off.
705
706 Q: Okay.
707
708 Q1: How did they, ah, put the gas into the window? Did you see it?
709
710 A: It looked like it was attached to the end of the pole.
711
712 Q1: Okay.
713
714 Q: And, um, how long would you say gas was introduced into the trailer?
715
716 A: How long like, how long did they put gas in there?
17
718 Q: Yeah.

719
720 A: Um, around well when they first started, it sounded like they were shooting
721 the gas in. But I never saw 'em. I could just hear it. Um, and it sounded like
722 it went on for 10, 20 minutes maybe.
723
724 Q: Okay.
725
726 A: Maybe not that long.
727
728 Q: Okay. And was there anybody on the number two side that you could visibly
729 see from your guys's location?
730
731 A: Couldn't see anybody on the number two side.
732
733 Q: So – and you guys were pretty much responsible for number one side.
734
735 A: Yes.
736
737 Q: Okay.
738
739 A: (Bishop) was pretty much responsible for the number two.
740
741 Q: Okay. Um, do you still hear, ah, attempts to negotiate, surrender orders, stuff
742 like that?
743
744 A: Yes. Every time they fired gas and then the volleys – the volleys stopped I'd
745 hear the negotiators tellin' the [REDACTED] ah, to come out leave the weapons
746 inside, come out with your hands up, there would be officers there to tell you
747 what to do, you know, they wanted to have it end peacefully and all that type
748 of stuff.
749
750 Q: Were – was there ever a response from the person inside?
751
752 A: I never heard anything from – from the person inside.
753
754 Q: Okay. Um, as this goes on, what's the next thing to happen that you either
755 hear or observe?
756
757 A: Um, I can't remember after which volley it was, but, um, Dep – (Bishop)
758 could see the – the [REDACTED] in the number two room covered in a blanket
759 crawlin' around on the floor.
760
761 Q: And he's got a higher up view?
762
763 A: Yeah, he's up on top of the hill lookin' down in through that window.

764
765 Q: Okay. Is – is gas still continuing to be introduced into the trailer?
766
767 A: Yes.
768
769 Q: Okay.
770
771 A: There's – I don't know how many – there was a couple different volleys. Ah,
772 I think they talked about EPD. And I believe EPD was shooting some into the
773 – the number two side.
774
775 Q: Okay. Um, what happened after that?
776
777 A: Um, after E – I mean after every volley I could hear the negotiators talkin'.
778 Um, and then there was a lot of gas comin' out of the house out of – mostly
779 out of this side over here, the four and three. And then it stopped for a while
780 probably, mm, 15, 30 minutes. It looked like it would – it cleared out. Um,
781 and then at first I thought a canister must have been activated late or
782 somethin' because there started – looked like there was some more gas started
783 comin' out of the – the east window, out of that side, the four and three
784 corner. And – but then it started to look like smoke.
785
786 Q1: Well so at first what color was it?
787
788 A: Um, kind of a – a white.
789
790 Q: Okay. And then it – then you knew it was black smoke.
791
792 A: Yeah, it started – it got – started to get thicker.
793
794 Q: Okay.
795
796 A: And then it started gettin' the black – black color to it.
797
798 Q: Okay. And at any time did you hear anything about anybody seeing flames or
799 anything like that?
800
801 A: Um, I heard the negotiators on the PA telling the guy to come out of the house
802 because it was on fire.
803
804 Q: And he's still in the house.
805
806 A: And then no response. Um, after a while the smoke kept gettin' thicker and
807 thicker. And then the negotiators sounded like they were on there pretty much
808 non-stop trying to get the – talk the guy out. Um, I could clearly hear 'em --

809 the house was on fire, you need to come out with your hands up, things like
810 that. And then I saw flames start comin' out of the roof of the four –
811 four/three corner (unintelligible) side...
812
813 Q: Okay.
814
815 A: ...in that area.
816
817 Q: Okay. And, ah, as they're – they're trying to get the [REDACTED] to respond,
818 they're talkin' the whole time until, I mean, the house eventually burns down.
819 Are they talkin' the whole time until it's fully engulfed?
820
821 A: Sounded like they were – they were talkin' pretty much non-stop just
822 repeating over and over the house is on fire, you need to come out, um, pretty
823 much the whole time.
824
825 Q: Okay. So even when you – Tony, when you first saw the flames from what
826 you say is the three and four corner...
827
828 A: Mm-hm.
829
830 Q: ...um, would it – would it be safe to say it was – a lot of time had passed in
831 people yelling obviously on a PA to – to [REDACTED] inside, that, yeah, it wasn't a
832 fire that just happened and engulfed the whole trailer?
833
834 A: No, it – the fire actually took a long time. I don't know if it's 'cuz of the
835 metal roof or what, but there – when the flames started coming out of the
836 number four and three side, it – it must have been 45 minutes at least before
837 smoke – any type of smoke started comin' out of the number one and number
838 two sides.
839
840 Q: Okay. And if – if I can remember from being up there, this – the two and one
841 side here from where the bathroom and I believe another bedroom were, the
842 back bedroom, it wasn't all that burnt – the view that you guys had.
843
844 A: Yeah.
845
846 Q: Okay.
847
848 A: Yeah, this was – I mean like these this side really took...
849
850 Q1: The number four side.
851

852 A: Yeah, the four and three, this side – the four side really – I mean after the fire
853 had got goin' the number one and number two didn't have near the damages
854 of the number four side.
855

856 Q: Okay. Ah...
857

858 A: I just kept waitin' for him to come out from either the front door, or the
859 bathroom window, or the number one window.
860

861 Q: Well you'd actually mentioned to us earlier that your guys's plan was to
862 maybe try to get him out of windows on either the two or one side.
863

864 A: Yes, that's correct. And so those were the last to even somewhat burn and
865 still nothin'.
866

867 Q: Mm-hm. Um, and you – you didn't dispense any gas at all?
868

869 A: No.
870

871 Q: Okay. Do you know who did?
872

873 A: Um, I believe it was - (Jamie Bernie) and (Brian Taylor) are our gas guys.
874

875 Q: Okay. And while you were, um, out there, Tony, um, did you hear any radio
876 track – radio track – radio talk or any planning on using, ah, pyrotechnics or
877 anything like that?
878

879 A: Ah, my battery went dead at about, mm, like maybe during the first volley of
880 gas. My battery went dead, and I couldn't hear nothin' after that.
881

882 Q: Do you have any experience with gas and that, or is that left up to the other
883 SWAT team members?
884

885 A: Gas – I have no experience in gas.
886

887 Q: Okay. Which leads to, you know, some of 'em on the SWAT team – some
888 were – have specialty positions and some...
889

890 A: Yeah, just like the snipers, I think, um, (Brian) and (Barn) – or (Brian Taylor)
891 and (Bernie) recently gone to the gas school.
892

893 Q: Tony, goin' back to when you were at the front of the – the Tribal vehicle and
894 you see an o – the window open, you see an object, um, come out. And you
895 can't really tell what the object is.
896

897 A: Mm-hm.
898
899 Q: Um, then all of a sudden you feel that you he -- feel the concussion and he --
900 know it hits the vehicle you're standing next to.
901
902 A: Mm-hm.
903
904 Q: Ah, what's going through your mind at that time?
905
906 A: Holy shit. I can't believe he just shot at us again. Um, I think it was more of
907 a shock because I didn't know what -- what he was really doing or planning on
908 doing when the window opened. Um, I was on my toes because (Brian
909 Taylor) had told us that he had opened the window prior to shooting, ah, the
910 first time. But, ah, it's a little -- I didn't really see anything. I just saw an
911 object push the window open. And the room was hard to see in. It was all --
912 there was a glare comin' off from that side, and the room was real dark in
913 there.
914
915 Q: Okay. And the purpose of you returning fire was what?
916
917 A: To get -- quit him -- get him to quit shooting at us.
918
919 Q: Do you -- do you think he was, ah, trying to kill you guys?
920
921 A: There's no doubt in my mind.
922
923 Q: Okay. And these two Hoopa Valley Tribal, ah, Explorers or whatever
924 (unintelligible)...
925
926 A: Expeditions.
927
928 Q: Expeditions -- were they -- were they marked with -- with police logos and
929 light bars?
930
931 A: Yes, they were.
932
933 Q: Okay.
934
935 A: That was one of my -- what was really scary was I knew he had a rifle with a
936 scope on it. And we were, um...
937
938 Q: Was that (unintelligible)?
939
940 A: I think so.
941

942 Q: Di – what other – and besides that one, what other intel did you have on
943 (unintelligible)?
944

945 A: Um, that he had access to a handgun and possibly an AK47 and a AR15 rifle,
946 ah, with lots of ammo.
947

948 Q: Okay.
949

950 A: And...
951

952 Q: And he already had shot (unintelligible)...
953

954 A: ...he had already shot. He pointed the guns at the first officers when they
955 were doing the welfare check. But it sounded like he didn't fire then, but fired
956 at (Brian Taylor) and, ah, the other people that were down there right before
957 we arrived. And I thought he was – he was trying to – trying to kill me or kill
958 the other guys on the team.
959

960 Q: And when you – when you're standin' here, Tony, and you said you – you –
961 you could feel the concussion, could you tell if it was to your left, or right, or
962 anything like that?
963

964 A: It felt like it was right in front of me and down on the left.
965

966 Q: Okay.
967

968 A: So it would have been like around the front of the vehicle or something like
969 that. It felt like it hit the hood, so...
970

971 Q: Okay.
972

973 A: I also had – we also had hostage negotiators too in the second vehicle, which I
974 was concerned about because he had already shown that he could hit that
975 vehicle as well because there was a bullet hole in that windshield from the
976 first time he'd shot at (Brian Taylor).
977

978 Q: And how far would you say you guys were away?
979

980 A: I would say...
981

982 Q: From at least the window he's shooting from?
983

984 A: From the window 60, 70 yards maybe.
985

986 Q: Okay.

987
988 A: And...
989
990 Q: You're a hunter, right?
991
992 A: Yeah.
993
994 Q: With a scope how – how accurate of a shot can that be?
995
996 A: That can be very accurate. I was very concerned about leaving my head
997 exposed. But I had to – to cover the house. And when the – when he shot, I
998 drove right behind that shield as fast as I could.
999
1000 Q: Okay.
1001
1002 Q1: And did – did you – did you hear the shot at first?
1003
1004 A: I heard a crack...
1005
1006 Q1: Okay.
'007
.008 A: ...yeah. And (unintelligible) it was...
1009
1010 Q1: Like somethin'.
1011
1012 A: Yeah, so, you know, it was just like boom, boom, real – real quick from the
1013 sound of the crack to the impact.
1014
1015 Q: Okay. Um, was there any – any mention that you heard, Tony, of why the fire
1016 started or anything like that you heard of?
1017
1018 A: Um, no. I heard somebody talkin' about during the night that he'd built –
1019 somebody had saw that he built a fire in the wood stove and – and...
1020
1021 Q: Did you ever see smoke comin' out of the chimney or anything?
1022
1023 A: I ne – I don't recall. I was lookin' through the – our night vision goggles so –
1024 most of the time, ah, you know, when it was dark. Ah, I – I never saw any
1025 smoke comin' out of the – the wood stove. Somebody said that he had had,
1026 ah, the door open on – door or doors open on the wood stove. Um, and when
1027 I was down here, it looked like there was some kind of covering over the 4B
1028 window. So I couldn't directly see into it. Um, but at night what I thought
1029 was a TV flickering on and off, um, some time during the night it had got
.030 really bright and was – it looked more like a fire than a...
1031

1032 Q: Show me where.
1033
1034 A: Ah, it looked like it was coming from about, mm, right in here somewhere.
1035
1036 Q: So somewhere away a little from the number 4B window somewhere in there?
1037
1038 A: Yeah, it might have been a little farther back. I just know it looked like most
1039 of the light was coming out like this way.
1040
1041 Q: Okay. So somewhat comin' from – from the west going east.
1042
1043 A: Yeah.
1044
1045 Q: Or from the number one side to the number two side.
1046
1047 A: Yeah.
1048
1049 Q: Okay.
1050
1051 A: And it was way more intense than – like it looked like a fire. It didn't look
1052 like a TV. It was too bright and was puttin' out too much light. It was
1053 flickerin' way too fast. It looked like a fire.
1054
1055 Q: Okay.
1056
1057 A: That was in the middle of the night.
1058
1059 Q: Okay. Um, I – I – in your opinion, Tony, is – is there anything else you guys
1060 could have done possible to – to get him to cooperate in some way? Is there
1061 anything else you think that could have been done?
1062
1063 A: I don't think there is anything else that could have been done. I think we
1064 exhausted every effort possible to him to end the situation peacefully. But the
1065 house was in a horrible spot for us. We had no...
1066
1067 Q: Right.
1068
1069 A: ...cover. It was wide open all around the house. We couldn't get close to
1070 throw a phone in. Ah, ah, we didn't have many options.
1071
1072 Q: And, ah, obviously I – I believe, when you have an active shooter, I – I don't
1073 think – you guys don't put phones in at that point.
1074
1075 A: That's correct. It's too dangerous.
1076

1077 Q: Okay. I see you shoot a – or you've been issued a Colt M16 (unintelligible).
1078
1079 A: Yes.
1080
1081 Q: What kind of training have you had with that?
1082
1083 A: Um, qualified with it at the – on a (Simpson) range. Um, I shot I don't know
1084 how many rounds at the two week SWAT school, um, in all kinds of different
1085 situations, you know, clearing houses and, um, shooting with people shooting
1086 next to you, and stress – stressful situations, and several trainings, um, ah, I
1087 think we had some trainings out at CR where we shot. Um, that's about it for
1088 that – for that weapon.
1089
1090 Q: As part of that training for either the SWAT team or the SET team for the
1091 Sheriff's Department or as just a sheriff, do you have qualification
1092 requirements throughout the year?
1093
1094 A: Yes.
1095
1096 Q: What are those? Do you know?
1097
1098 A: We have to qualify twice a year with the long gun. Um, and we have to be
1099 able to shoot – do you wanna know like what the qualifications
1100 (unintelligible)...
1101
1102 Q: No, just that you do qualify for the...
1103
1104 A: Yeah, twice – twice a year with the...
1105
1106 Q: And who's in charge of like a ring trust or who's your ring trust...
1107
1108 A: Um, (REDACTED).
1109
1110 Q: Okay. You also mentioned at different points of time on this, ah, staying near
1111 some vehicles. Ah, it sounds like you were kind of in a bad situation. That
1112 door opened, and you're looking towards this – this house. Do you have any
1113 type of scope, or sight, or what type of sights do you have you have on your
1114 Colt?
1115
1116 A: On my have just the standard straight iron sights.
1117
1118 Q: You have no scope or nothin', just a straight iron sight?
1119
1120 A: No. Straight iron sights.
1121

1122 Q: Okay. Um, and did you have night vision available? Ah, were you using any
1123 night vision or...?
1124

1125 A: We were after it got dark. When he shot at us it was still daylight.
1126

1127 Q: Okay. Um, one point you say you saw his hand and arms through looks like it
1128 would be the 4A window.
1129

1130 A: Yes.
1131

1132 Q: Made a comment, and I think you said, "Come and get some, fuckers" and he
1133 was hootin' and hollerin'. Anything specific other than that you – you
1134 remember him saying?
1135

1136 A: I – that is the only thing I could make out.
1137

1138 Q: Um and then...
1139

1140 A: I couldn't understand a lot that he was hootin' and hollerin'.
1141

1142 Q: Okay. You also made a comment that sounded like you said somethin' about
1143 a grenade.
1144

1145 A: Yeah.
1146

1147 Q: Do you remember what that might have been about or what context that was
1148 in?
1149

1150 A: Um, that was later in the night. And all I heard was somethin' about a
1151 grenade. And I think so – somebody else said he said something like, um, the
1152 house is full of grenades or something like that.
1153

1154 Q: From the little bit that you could hear from him, did it sound like he was
1155 attempting to contact anybody, or is he just makin'...
1156

1157 A: No.
1158

1159 Q: ...shouting for no reason?
1160

1161 A: Yeah.
1162

1163 Q: What did it sound like to you?
1164

- 1165 A: To me it just sounded like he was – wasn't trying to contact anybody outside.
1166 He was just randomly yelling, and screaming, and a lot of the stuff didn't
1167 make sense. I – or I couldn't understand.
1168
- 1169 Q: And then also lookin' at this diagram we have here of the vehicle that you
1170 were at for a good portion of that time there's a vehicle behind that.
1171
- 1172 A: Mm-hm.
1173
- 1174 Q: There was a negotiator in that vehicle?
1175
- 1176 A: Yes. I think there might have been two negotiators in this vehicle when he
1177 shot.
1178
- 1179 Q: And then also there is a PA being used, verbal commands or requests or
1180 somethin' being said. Do you remember what types of things were being said
1181 and who specifically was saying that?
1182
- 1183 A: Um, after he had shot or during the whole time?
1184
- 1185 Q: During the whole time.
1186
- 1187 A: Um, I know I heard, um, (Jason Daniels) and (Mike Fridley) talking a lot on
1188 the PA system. And a lot of it was, um, um, they were trying to get him to
1189 communicate. Um, I'm trying to think of their words. They were trying to
1190 get him to come out of the house peacefully. Um, you know, they can't – they
1191 can't help him if he doesn't come out. They wanna end it peacefully. Come
1192 out with your hands up. Leave the weapons inside and come outside, and the
1193 officers will instruct – instruct you what to do. Um...
1194
- 1195 Q: Any other people other than Deputy (Daniels) or Sergeant (Fridley) that you
1196 heard talking?
1197
- 1198 A: Um, the – the next morning on the fork I guess it was, um, I heard some –
1199 some other people talkin' on the PA, ah, tryin' to negotiate with him. But I
1200 don't – I don't – I didn't recognize the voice.
1201
- 1202 Q: Okay.
1203
- 1204 A: I don't know who it was. But there was different people on it.
1205
- 1206 Q: Okay. Um, then after – at some point you guys are relieved by the (Eureka)
1207 Police Department SWAT team.
1208
- 1209 A: Mm-hm.

1210
1211 Q: You take a break, and then you return. And you – when you return, you
1212 actually go to a new area at this structure where you can visibly see the
1213 number one and number sides, as we're lookin' at this diagram.
1214
1215 A: That's correct. Couldn't see the number two side real great, but...
1216
1217 Q: So you had a very good...
1218
1219 A: ...I could see the number two window.
1220
1221 Q: You could see a partion – or the number two window and then you could see
1222 most of number one.
1223
1224 A: Yes, I could see all of number one.
1225
1226 Q: You talk about the smoke and stuff you can see on that – the number three and
1227 four sides, um, as the detective asked you about how that was happening.
1228 You couldn't actually see the side, but you could see smoke coming up.
1229 Would that have been like through the roof or I mean how – how did that
1230 work?
1231
1232 A: Um, on – when it was comin' out of the number three and four?
1233
1234 Q: Yeah.
1235
1236 A: From my angle and lookin' over the roof, to me it looked like I couldn't tell if
1237 it was coming out of the windows or what. I just saw as it got above the roof
1238 line.
1239
1240 Q: On that...
1241
1242 A: On the number four and number three sides.
1243
1244 Q: Okay. That's all I have.
1245
1246 Q1: Tony, when – when you got shot at and you ducked down and came back up
1247 and put your sights on the four side, the A window, and when you fired, was
1248 that a – would you con – say that would be a suppression fire, or did you
1249 believe he might be comin' back up to that window to fire more rounds?
1250
1251 A: I thought he was gonna shoot more.
1252
1253 Q1: Okay.
1254

1255 A: He shot at least three the first time he shot. And one shot went off. I thought
1256 he was gonna fire more rounds. And I wanted to put rounds down range to
1257 stop him from shooting anymore rounds at us.
1258

1259 Q1: Okay.
1260

1261 Q1: 'Cuz you guys are not in a real good spot that's already been shot once.
1262

1263 A: It's already been hit once by three bullets, and there's not – it was not very
1264 good cover.
1265

1266 Q1: Okay. And...
1267

1268 A: Plus I did not know which weapon he was firing at. If it was an AK47, an
1269 AR15, or if it was a .22 with a scope, or a handgun, I don't know.
1270

1271 Q1: Okay. And – and on your, ah, training, ah, when you qualify or train with the
1272 SET team, is that documented?
1273

1274 A: Yes.
1275

1276 Q1: Okay.
1277

1278 W: Hi.
1279

1280 Q: (Unintelligible)
1281

1282 W: Um, can I – I'm gonna close and lock that door, but I'll leave you this door
1283 (unintelligible). And (unintelligible) turn the light off.
1284

1285 Q: All right. You got anything else, Steve?
1286

1287 Q1: No.
1288

1289 A: There was one more thing that I forgot. When it was night out and we were
1290 just watching the house, um, to contain him, we did – I did see a couple times
1291 a flashlight in the 4A and 4B window.
1292

1293 Q: The first night you did.
1294

1295 A: Yes, period – before EPD relieved us periodically through the night I could
1296 see a flashlight in both those windows, flashlight beam.
1297

1298 Q: Tony, um, is there anything that we haven't asked you about the incident that
1299 would be important for us to know that you can remember?

1300
1301 A: Not that I can think of.
1302
1303 Q: Okay. Can you go ahead and, ah, sign that right there for me?
1304
1305 A: Here?
1306
1307 Q: Paul, do you got anything to add?
1308
1309 Q2: Just real quick, after – after the house appeared to be in flames, did you ever
1310 hear any more rounds being fired off?
1311
1312 A: Yeah. When the house – when the fire got goin' in the house, there was
1313 several sounded like gunshots goin' off. We didn't know if it was him
1314 shooting, um, at us or out of the – out of the house or if it was just ammo in
1315 the house that was going off because of the fire. So it was definitely not safe
1316 to have the fire department come down or for us to move in. When the fire
1317 department did come in, we had to go up with them and provide cover for
1318 them because the [REDACTED] had not exited the house.
1319
1320 Q2: Okay.
1321
1322 Q: Anything else?
1323
1324 Q2: No.
1325
1326 Q: I'm gonna end the interview at 1646 hours.
1327
1328
1329 This transcript has been reviewed with the audio recording submitted and it is an accurate
1330 transcription.
1331 Signed _____

INTERVIEW WITH BRIAN TAYLOR

Q=Det. Rich Schlesiger

Q1=Inv. Steve Dunn

Q2=[REDACTED]

A=Brian Taylor

1
2
3
4
5
6
7
8
9
10
11
12
13
14
15
16
17
18
19
20
21
22
23
24
25
26
27
28
29
30
31
32
33
34
35
36
37
38
39
40
41
42
43
44
45

Q: Okay, the date June 7, 2007. The time is 0925 hours. Case 200703162. Present is, uh, Detective Schlesiger, Investigator Dunn, uh, Deputy Brian Taylor, and his representative, uh, [REDACTED] Um, we're in the conference room of the Sheriff's Office. Um, is it B-R-Y?

A: I.

Q: I. What's your middle initial, Brian?

A: M.

Q: And your pin number.

A: 1377.

Q: And Brian, are- we've been assigned to the CIRT Team- obviously has been assigned to, um, investigate the officer involved shooting, and- and all that surrounded that that happened on the 3rd and the 4th of June. Um, and, um, you're here to give us a voluntary statement?

A: Yes.

Q: Okay. How, um, also, um, how long have you been a deputy sheriff now?

A: It'd be five years in August.

Q: Okay. And just with us?

A: Yes.

Q: Okay. And, um, where are you currently assigned?

46 A: Uh, resident deputy at the Hoopa Station.
47
48 Q: Okay. Um, and are you a member of the SWAT Team or Special
49 Enforcement Team?
50
51 A: Yes.
52
53 Q: Okay. How long have you been a member?
54
55 A: Um, over a year. It was, uh, a year in April, so.
56
57 Q: Okay.
58
59 A: So 14 months or so.
60
61 Q: Okay. And to be a member of the SWAT Team or SET Team, have you, uh,
62 received any special training?
63
64
65 A: Yes.
66
67 Q: What was that?
68
69 A: Uh, basic SWAT school in Alameda County.
70
71 Q: Okay. And, um, on June 3, um, where you working on June 3?
72
73 A: No.
74
75 Q: No. Um, had you worked the previous night?
76
77 A: Uh, it was Sunday. I worked Saturday night, yes.
78
79 Q: Okay, Saturday from when to when?
80
81 A: Uh, until 2:00 am.
82
83 Q: Okay. Um, obviously you're probably- were you called at your residence?
84
85 A: Yes.
86
87 Q: What time was that?
88
89 A: I received a page and then I phoned dispatch, I believe it was 4 o'clock.
90

91 Q: Okay. And what were you advised?
92
93 A: Uh, the SET call-out on Bald Hill at Pine Creek. They told me there was, uh, a
94 5150 that was brandishing weapons at deputies.
95
96 Q: Okay. And, uh, where did- where did you respond to?
97
98 A: To the () residence, or what I was told was the () residence on-
99 they said Bald Hills initially at Pine Creek. And it ended up being Translator
100 and Bloody Camp Road depending on what you call it.
101
102 Q: Okay. Have you ever been out to that residence before?
103
104 A: No.
105
106 Q: Okay. Um, you recall what time about you arrived?
107
108 A: I would say approximately 515, 530.
109
110 Q: Okay. And, um, what were you dressed in at that time?
111
112 A: Uh, my camouflage BDUs and SET gear.
113
114 Q: Okay. And um, were you driving your marked patrol unit?
115
116 A: Yes.
117
118 Q: Okay. When you get on- on scene, um, you go down the driveway, where did
119 you- where did you park? What did- what did you do from there?
120
121 A: Um, I parked, uh, directly behind a Tribal unit that was, um, parked up around
122 the bend a little from these SUVs right here.
123
124 Q: And you're pointing at, um, we drew a little sketch here of, uh, kind of the
125 scene, the house, the driveway, and where Bloody Camp Road is. So you-
126 you were parked a little bit behind the two, uh, Hoopa Tribal Police units?
127
128 A: From where I was, actually there's more of a little sweep in the road here.
129
130 Q: Mm-hm.
131
132 A: Um, you could barely see the rear of this car and there were several other cars
133 ahead of me.
134
135 Q: Mm-hm.

136
137 A: I was parked back in here.
138
139 Q: Okay. How many- how many other vehicle were there?
140
141 A: I believe there was Sergeant (Miller)'s car and a Tribal Police car. And then
142 these two.
143
144 Q: Okay.
145
146 A: Um, and maybe, no, I think a Chippy car was on the road, so...
147
148 Q: Okay.
149
150 A: ...that would be about it.
151
152 Q: Okay. Um, where did you go from there?
153
154 A: Uh, I met there with Sergeant (Miller). Um, he's a sergeant with the SET
155 Team. And he told me to get up and grab my equipment and respond to the
156 lead vehicle to take over, um, securing the perimeter from the patrol deputies
157 or whoever was on scene up there.
158
159 Q: Okay. And being in a sub-station, do you carry all your gear with you?
160
161 A: Yes.
162
163 Q: Okay. And, um, when you went to the- to the Tribal vehicles, who was there?
164
165 A: Uh, Sergeant (Ed Gower) was there from Tribal Police, um, Officer (Spallino)
166 from Tribal Police, um, Officer (Nolan) from the CHP, I believe there was one
167 other person, but I can't recall who.
168
169 Q: Okay. And where did you take apposition at?
170
171 A: I took a position in the, uh, driver's side door of the number one vehicle
172 closest to the residence.
173
174 Q: Okay. Brian, can you put your initials where you were and where the other
175 officers were at?
176
177 A: Do you want me to put...
178
179 Q: Their initials, yeah. Okay. And, at that time, do you have any weapons drawn
180 or anything like that?

181
182 A: Yes.
183
184 Q: What did you have?
185
186 A: I had my M-16 trained, uh, on the residence.
187
188 Q: Okay. And, um, what, um, did you observe at- from the house at that time?
189
190 A: Nothing at the time.
191
192 Q1: Okay.
193
194 A: The windows were open. I observed the A window on the fourth side was
195 open and also it appeared that the B window was open.
196
197 Q1: Okay, could you hear anything?
198
199 A: Uh, now and again there'd be talking, uh, or noises, screaming, yelling
200 coming from- from the inside of the house.
201
202 Q1: Okay.
203
204 A: Sometimes you could hear what he was saying, sometimes you couldn't.
205
206 Q1: Okay. What occurred next?
207
208 A: Um, I'd say 15 to 30 minutes into it, he, uh, I could hear him yelling at us. He
209 came to the A window, and leaned out the A window. I could see almost all
210 the right side of his body, but not the left. I couldn't see his left arm. He was
211 wearing a maroon shirt, like a beige, Indian-style stocking cap. And started
212 saying, you guys need to back the fuck outta here. I'm gonna start cappin'
213 you all. I'm gonna grab my M-16, and- and then he withdrew into the
214 residence.
215
216 Q: Okay. And did you see any weapons at that time?
217
218 A: Not at that time.
219
220 Q: Okay. ([REDACTED] do you- have you had any dealings with him?
221
222 A: I have not. I know who he is and I have seen him when out on patrol, and, uh,
223 Sergeant (Farley) pointed him out to me and advised me he was the one who
224 [REDACTED] a week ago or so.
225

226 Q1: That was fairly recent?
227
228 A: Yes.
229
230 Q1: Okay.
231
232 A: Probably a week to, uh, 12 days before this incident.
233
234 Q1: Okay.
235
236 Q: And, as you guys were still standing there, and what else occurred?
237
238 A: Um, then, I'd say anywhere from 10 to 15 minutes, later, all of a sudden, um, I
239 observed a black, uh, what appeared to be a rifle barrel start poking out of the
240 edge of the window from the blackness, and he fired, uh, two shots, uh, in our
241 direction, and I returned fire.
242
243 Q: Okay. So when the barrel's poking out of here, can you see where it's being
244 pointing? Can you see who's holding it or anything like that?
245
246 A: I can't see who's holding it. I can't see a person. All I see is the length of a
247 barrel. Probably- it looked like, uh, I don't know, it was hard to say, but a long
248 barrel.
249
250 Q1: What color was the barrel?
251
252 A: Black.
253
254 Q1: Okay.
255
256 Q: And, is it pointing towards you guys?
257
258 A: Yes.
259
260 Q: At that time when it's pointed towards you guys are- is- are rounds fired out
261 of it?
262
263 A: Yes.
264
265 Q: Okay. And you say it was two rounds?
266
267 A: Yes.
268
269 Q: Okay.
270

271 A: At- at least.
272
273 Q: Okay. And you were still standing in the same position you were?
274
275 A: I was kneeling in the driver's side door. This seems a lot farther than it
276 actually. It's about 65 feet or so.
277
278 Q: Okay.
279
280 A: It's what we got on the range finder.
281
282 Q1: Okay, 65 feet?
283
284 A: Yeah.
285
286 Q1: Okay.
287
288 A: We took the range finder up from when we began to throw gas, so.
289
290 Q1: Okay.
291
292 Q: And, um, at that time did you- did- when he fired, is your gun pointed at him
293 or at the residence?
294
295 A: One more time? What was that?
296
297 Q: When he fired, were you already positioned here with your gun pointing into
298 the residence?
299
300 A: Yes.
301
302 Q: Okay. And what did you do next?
303
304 A: Um, I- I returned fire.
305
306 Q: Okay.
307
308 A: After he had fired. I- I called out, I stopped for a minute as soon as the first
309 shot was fired, came on mic, advised shots fired. He fired the second shot,
310 and I returned fire.
311
312 Q: Okay. And, uh, where did you return fire to?
313
314 A: The barrel of the gun.
315

316 Q: Okay. And did you have a site picture?
317
318 A: Yes.
319
320 Q: And you returned how many rounds?
321
322 A: One.
323
324 Q: Okay, and, uh, was there any response from inside the residence after that
325 occurred?
326
327 A: He withdrew the barrel, and I did not see him again.
328
329 Q: Okay. Any idea where hid two rounds went?
330
331 A: After -- I didn't know at the time, I knew hey were in my directions, and, um,
332 we- I observed that there was a bullet hole in the, um, middle of the
333 windshield of the first vehicle where I was at and a bullet hole in the middle of
334 the second vehicle's windshield.
335
336 Q: Okay. And from these two Tribal vehicles, could you- could you all four of
337 you get a view to this A window?
338
339 A: Yes. This is not entirely correct. This building should be turned this way
340 because I was also later stationed here, and we did not have a direct view of
341 the number 1...
342
343 Q1: Okay.
344
345 A: ...window. This should be turned...
346
347 Q1: Kind of cocked more?
348
349 A: Yeah, cocked more, like that because these windows are more facing us.
350 They're (unintelligible) off a little at this type of an angle.
351
352 Q1: So the number 4 should be more like to the southeast?
353
354 A: Yes.
355
356 Q1: Okay.
357
358 Q: So you almost had a straight on view from, uh, the number 4 where you guys
359 could see?
360

361 A: Yes.
362
363 Q: Okay.
364
365 A: Not- yeah.
366
367 Q: And, uh, after that occurred, what happened?
368
369 A: Uh, we held our positions. At that time, the rest of the SET Team was just
370 arriving.
371
372 Q: Okay.
373
374 A: And re-enforcements were brought up.
375
376 Q: Did you ever move from that position there?
377
378 A: Uh, not at that time, no.
379
380 Q: Okay. Um, later on that evening, did you ever move?
381
382 A: Yes, I was relieved by other members that arrived. They took those positions
383 and I was brought back, and we responded, um, I responded with Sergeant
384 (Garcia), uh, Deputy (Lundy), Sergeant (Miller), and Deputy (Fulton) and, uh,
385 we took a path through the brush. It took us a long while to get up to here to
386 extricate, uh, the pin-down, Officer (Landreaux) and, uh, Deputy (Greg
387 Berry).
388
389 Q: Okay. How many hours or minutes or- or whatever, uh, Brian, were you guys
390 here until you were relieved until you and (Lundy) came around?
391
392 A: I would have to guess. I couldn't really say.
393
394 Q: Did...
395
396 A: Not a- not a great long time, maybe 30 minutes- more minutes after that.
397
398 Q: Okay, so it's fairly quick?
399
400 A: Yeah.
401
402 Q: Okay.
403

404 A: They were just arriving and then everyone, boom, was there. And I held that
405 position for a while, and then they said com back here, and someone took my
406 spot.
407
408 Q: Okay. And, when you- so you and (Lundy) take off and you guys go down to
409 the south?
410
411 A: And we came way down here to the tree line. There's an open, you know...
412
413 Q: Down there where those other residences are down there?
414
415 A: Yeah, past those to the tree line and we past through the brush all the way to,
416 uh, (██████████)'s house and back down this road to this vehicle.
417
418 Q: Okay. And when you arrived at the (Yurok) vehicle, right, who- who was
419 there?
420
421 A: Deputy (Greg Berry), someone I work with and (Heather Landro) Yurok PD.
422
423 Q: Okay, was there anybody else there?
424
425 A: No.
426
427 Q: Okay. Um, what did they advise you when- when you arrived?
428
429 A: Uh, the told us they were there for a welfare check and that he came out
430 brandishing a rifle and several times, and was acting crazy and they had to
431 back down and essentially pinned down there in fear that driving by that he
432 would shoot.
433
434 Q: Okay. And eventually, how did you extricate them out of there?
435
436 A: Uh, we held that position and covered, um, with the 1 and 2 sides so that they-
437 they could, uh, back out and I'm not sure which way they ended up going.
438 They didn't have radios. Their portables were dead.
439
440 Q: Okay.
441
442 A: Um, they got out and they either came out this way or went up the hill that
443 way.
444
445 Q: Okay.
446
447 A: I believe they went up that way.
448

449 Q: Okay, who- who was left there? You and who?
450
451 A: Uh, myself, Sergeant (Garcia), Sergeant (Miller), Deputy (Fulton), and
452 Deputy (Varline).
453
454 Q: Okay. When did the other guys come and meet you here? Because you and
455 (Lundy) were in here first?
456
457 A: No, no. All of us as a group.
458
459 Q: Oh.
460
461 A: The whole group were there first.
462
463 Q: Can you put the group's initials in there?
464
465 A: Right here?
466
467 Q: Yeah.
468
469 A: Including mine?
470
471 Q: Yes. Okay. And from that location, um when- when you arrived there, is
472 there anything going on in the residence?
473
474 A: Uh, we could hear, uh, we heard the second volley of shots. We heard, um, I
475 believe it was (Mike Fidelity) hostage negotiating, um, throughout the evening.
476
477 Q: When you guys get here, Brian, how long is it until you hear the attempts to
478 negotiate start?
479
480 A: I would say they were, uh, on-going, um...
481
482 Q: Okay.
483
484 A: "Cause there was an echo and I wasn't really paying attention. I was sweating
485 and breathing hard.
486
487 Q: Okay. Did you ever hear any responses from the house back to the
488 negotiators?
489
490 A: Uh, once we got over here, yeah, he would scream, uh, unintelligible things
491 all- every once in awhile, and was talking to himself or screaming about
492 grenades or something.
493

494 Q: Okay. Did he ever threaten anyone further that you heard?
495
496 A: Not that I know of.
497
498 Q: Okay.
499
500 A: Or that I could understand.
501
502 Q: Okay. And you guys take a position here and, so throughout the night,
503 negotiations go on with (Fidley) and (Daniels) or attempts to with this guy,
504 does anything occur at all?
505
506 A: Um, are we past he second volley of...
507
508 Q: No, I'm not there yet.
509
510 A: Okay. Um, no. We saw him, 'cause we had, again, this- this should be turned
511 this way.
512
513 Q: Mm-hm.
514
515 A: We had a clear view of the number 2, the window on the number 2 side which
516 appeared to be a bedroom window. And, uh, he's in there folding clothes and
517 talking to himself and acting strange.
518
519 Q: Okay. And now you mention this other volley of gunshots. Um, did they-
520 from what you know now, they probably came from the number 4 side?
521
522 A: Yes.
523
524 Q: So you didn't see any of those occur?
525
526 A: No we saw him -- well I was advised. I could not physically- I saw him in the
527 window. I was advised by I believe (Bishop)- he was letting everyone know
528 that he appeared to set a rifle down in that room, and it appeared he was
529 folding clothes. And then he left that room, and sometime after that I believe,
530 is when that happened.
531
532 Q: And what- what did (Bishop) do for the team?
533
534 A: Uh, he's a sniper.
535
536 Q: Okay. And, um, so over the radio, he- he announces that?
537

538 A: Yes, and we could see him doing something. You could see he- he had took
539 his shirt off or something.
540
541 Q: Okay.
542
543 A: I could see that with my naked eye.
544
545 Q: Back real quick, Brian, do you have a specialty on the team, uh, SET Team?
546
547 A: I've just been on- I'm a gas man now.
548
549 Q1: You just went to the school?
550
551 A: Yes.
552
553 Q1: Okay.
554
555 Q: Um, so you- you said something about this second volley. Any idea of what
556 time that is or anything like that?
557
558 A: No I wasn't- I had taken my watch off because it rubs on my uniform.
559
560 Q: Okay, so it's been a while that's passed?
561
562 A: Some time, yeah.
563
564 Q: Okay. And so what do you - what do you hear as far as the volley?
565
566 A: I hear two small shots that sound like, you know, .22 to me, and- and a bunch
567 of loud cracks that were obvious to me that it was our guys shooting back.
568
569 Q: Okay. So two and how many would you say of ours?
570
571 A: It's hard to say because of the, um, echo in the valley. You know, you hear
572 one, it sounds like more.
573
574 Q: Right.
575
576 A: I would say at least four.
577
578 Q: Okay.
579
580 A: I mean, I was told it was six, I got that stuck in my head already.
581

582 Q: Okay. Um, and after those shots are fired, what about- what goes on in the
583 house?
584
585 A: Uh, we hear a loud screaming as if he were possibly hit. We thought, I mean,
586 from the screaming, it sounded like either anger and pain and/or one or the
587 other, you know.
588
589 Q: Okay. And, um, is negotiations still going on?
590
591 A: I believe so, right after.
592
593 Q: Right after that occurred?
594
595 A: Yeah.
596
597 Q: Okay. What- what goes on next after that?
598
599 A: Um, we held our position, um, until about 3- 3:00 am when EPD relieved us,
600 and we could see, uh, you could see in this window here, uh, just to the- the, I
601 guess that would be west to the front door, you could see what appeared to be
602 a TV going. And then, if you open the door, he had a second TV on the same
603 channel because the (unintelligible) were over there watching it with night
604 vision, and you could see it flickering all night and occasionally, you'd see
605 movement.
606
607 Q: No more yelling or anything like that?
608
609 A: Uh, not that I remember.
610
611 Q: Okay, so you guys are relieved by EPD officers?
612
613 A: Yes.
614
615 Q: SWAT Team members?
616
617 A: Yes.
618
619 Q: Okay. And you guys returned to -- how- how did you guys leave the area?
620
621 A: We came back and went out the same way we came in. It was dark now, so
622 we chanced going through the open field, went straight down and around, and
623 back.
624
625 Q: Okay.
626

627 A: Up to somewhere back here.
628
629 Q: Okay. And, uh, when you guys arrived there, um, you guys are still
630 operational at that point, right?
631
632 A: Yes.
633
634 Q: Okay. And you guys- did you decide to go somewhere to try to get a little bit
635 of sleep?
636
637 A: Uh, well no. We went to, um, all of us responded down to the Hoopa Station.
638 We ate a sandwich, and I think broke down maybe a total of an hour-and-a-
639 half and came back.
640
641 Q: Okay. And- and while you were down there, or at any time, Brian, did you,
642 uh, reload your magazine after firing that shot?
643
644 A: No.
645
646 Q: Okay. And, um, from what I recall, you guys had to be back at 6:00 am?
647
648 A: Yeah.
649
650 Q: Okay. And you guys were back at 6:00 am?
651
652 A: I think it was a little after 6:00 am.
653
654 Q: Okay. And, uh, from that point on, what goes on?
655
656 A: Um, well, now I was re-positioned with a different group of guys back with
657 this group of vehicles. Um, I was with Sergeant (Cronall), (Jesse Taylor), um,
658 (Jamie Barney) and, (Blake Lasoro) now. And I'm at this- these vehicles. We
659 basically held that position until the conclusion of the event.
660
661 Q: Okay. Down below the road here, can you put there. Put like number two
662 day or something. Okay, so you guys come down here -- well, let- let me
663 back up real quick, when you're up with the Yurok vehicle, was (Randy) your
664 team leader?
665
666 A: Yes.
667
668 Q: Okay, and the second day, Brian would be your team leader?
669
670 A: Yes.
671

- 672 Q: Okay. And overseeing all this was Lieutenant (Caventa)?
673
- 674 A: Yes.
675
- 676 Q: Okay. Um, so go ahead and start from the second day. What- what goes on?
677
- 678 A: Uh, we held that position. Um, uh, (Mike Fidley) again came down. CC guys
679 came down from the CIRT negotiators, I guess, I don't -- (unintelligible).
680 They talked to him for a long time. No response, uh, no noise, no nothing,
681 couldn't see him. Uh, they left, (McFinly) came back, uh, negotiated, talked to
682 him over the PA for a long time, I believe it was 11:00 or 11:15, uh, we held
683 out until, and then we began to introduce gas.
684
- 685 Q: Okay. Um, the negotiations continued all the way up to- or attempts to
686 negotiate continued all the way to the point to introducing the gas?
687
- 688 A: Correct.
689
- 690 Q: Okay, and the- at what point was it decided or by who it was time to introduce
691 gas?
692
- 693 A: Uh, the Command Post.
694
- 695 Q: Okay.
696
- 697 A: Lieutenant (Caventa). We, um, had talked about it and decided we were going
698 to wait until that time and continued negotiations to give him the opportunity
699 to exit the residence, surrender.
700
- 701 Q: Okay.
702
- 703 A: And if he failed to at that time, we would begin to introduce gas. It was
704 decided before hand.
705
- 706 Q: Okay. And what was the plan of where the gas was going to go in at?
707
- 708 A: Um, the initial plan was to introduce into the A and B windows on the number
709 4 side.
710
- 711 Q: Okay. And why was that?
712
- 713 A: I couldn't say, I didn't make the decision.
714
- 715 Q: Okay. Um, so when you guys start introducing the gas, who introduces the
716 gas into the residences?

717
718 A: Well, the first volley, I- I actually pulled the trigger on the gun and introduced
719 all the gas?
720
721 Q: Okay, and what type of, uh item, is that or gun do you use to introduce that?
722
723 A: Uh, it's a 37 mm launcher, less-lethal launcher.
724
725 Q: Okay. And is it a breach-open or is it the one with the...
726
727 A: Yeah. There was a single breach-open.
728
729 Q: Okay, and what type of, I guess ferrets?
730
731 A: Uh, yes, the first volley was all ferret rounds.
732
733 Q: Okay. They're called- there's ferrets for shotguns ferrets, there's ferrets for a
734 37 mm correct? And these were out of a 37 mm?
735
736 A: Correct.
37
738 Q: Okay. And you were told by who to shoot the gas in there?
739
740 A: Lieutenant (Caventa) and, uh, and I heard over the radio by Sergeant
741 (Quinell).
742
743 Q: Okay.
744
745 A: Directly.
746
747 Q: And was Brian down there at that time?
748
749 A: Yes.
750
751 Q: Okay and what was the plan? The first volley was to go where?
752
753 A: Uh, we were supposed to, I believe five good shots into the A window and
754 five into the B window.
755
756 Q: Okay, and that's on the number 4 side?
757
758 A: Yes.
759
760 Q: Okay. And, how far away were you guys? Did you ever get that?
761

762 A: Uh, we didn't know at the time, we believed it was about 75 feet which the
763 effective range is 50 feet. We weren't even going to take the shot initially.
764 We were going try to move up here but we thought it was too dangerous. So
765 we tried from there, and it turned out to be 65 feet according to um, I believe
766 it was (Louis- Louis Altec). He brought a rang-finder over there later.
767

768 Q: Okay, and, m, those rounds- were you successful in getting them into the
769 windows?
770

771 A: Yes. It took more than, I mean, every shot did not hit, um, directly into the
772 windows. Um, we had some lows, some highs, and some to the side. And
773 from that distance, the ferrets don't penetrate the walls, um, so we fired quite
774 a bit more than 10.
775

776 Q: Okay. Do you have any idea how total you fired into there?
777

778 A: I couldn't- couldn't even guess. There were a pile of them on the ground. All
779 the, uh, if I had to guess, I would say maybe 20 the first time.
780

781 Q: Okay. So you began by five in each- each window, correct?
32

783 A: Correct.
784

785 Q: And obviously when you were shooting, you noticed, these aren't going in?
786

787 A: Well some of them are, yeah.
788

789 Q: Okay.
790

791 A: So we can continue until we got five in.
792

793 Q: Okay. And, um, so you kept- you kept shooting into the windows until you
794 got five in each window, is that correct?
795

796 A: Yeah. I believe we may have got four in one and, I wasn't that close to the
797 radio...
798

799 Q: Okay.
800

801 A: ...to be 100%, but that was the goal.
802

803 Q: Okay.
4

805 A: And we got close to, uh...
806

807 Q: So, would that have been, Brian, one volley then even though you shot those
808 many or?

809
810 A: Yes.

811
812 Q: Okay, so the plan was just keep going until you got five in each window?

813
814 A: Yes.

815
816 Q: Okay. Did anything occur inside the house at that time?

817
818 A: No.

819
820 Q: Was there attempts to negotiate or surrender orders at that time?

821
822 A: Yes.

823
824 Q: And no response?

825
826 A: And no response before or after.

27
828 Q: Okay. Was there ever a second volley?

829
830 A: Yes.

831
832 Q: Okay. Who- who, uh, shot those?

833
834 A: I believe it was me again.

835
836 Q: Okay was that the 37 mm?

837
838 A: Yes.

839
840 Q: Okay. Um, how- how did those go?

841
842 A: Uh, better. The second time.

843
844 Q: Okay. Not, um, not so many, but it was still five in the A and five in the B

845
846 again?

847 A: Correct, we had we basically exhausted our supply at that point.

848
849 Q: Um, and who...

850

851 A: Actually, that's not correct. We fired a third- a third volley with, uh, different
852 stuff that ended up being bad stuff that didn't make it to the house.

853
854 Q: Okay.

855
856 A: That was, (Jamie) did that.

857
858 Q: Okay. Um, so you do the first two though, is that correct?

859
860 A: Yes.

861
862 Q: Okay. And, um, it never- there's no- there's no responses or anything from
863 the house again?

864
865 A: Uh, there was no- no yelling. We didn't hear anything. Some time in there, I
866 believe it was after we- we completed all the volleys, um, which after that
867 third volley, we fired more, um, 12 gauge rounds into there. Um, after that, I
868 believe we were told that Deputy (Bishop) had seen him hiding under a
869 blanket in, uh, somewhere on the number 2 side.

870
871 Q: Okay. So after you're done- how much time is in between these volleys
872 would you say?

873
874 A: I can't even guess, I don't remember.

875
876 Q: Okay. So after the- you shoot yours, who goes, someone shoots a third
877 volley?

878
879 A: Yes. And- and at that point, um, I believe EPD was introducing gas at a
880 different, I believe either, uh, the 2 or the 3 side, I'm not sure, I believe it was
881 the 2 side.

882
883 Q: Okay. Were you guys shooting in at the same time or?

884
885 A: Alternating volleys.

886
887 Q: Okay.

888
889 A: Trying to drive him out.

890
891 Q: Okay. Of the number 1 side?

892
893 A: Yes.

894
895 Q: Which is the front door?

896
897 A: Yes.
898
899 Q: Okay. And, um, so after EPD introduces their gas, you guys shoot shotgun
900 ferret rounds in?
901
902 A: Yes.
903
904 Q: Okay, and who shot those?
905
906 A: Um, (Jamie) shot the majority and I also- I think I believe I fired the last
907 volley of ferret shotgun rounds.
908
909 Q: Can you recall how many volleys (Jamie) did?
910
911 A: I believe it was two.
912
913 Q: And that was five and five again?
914
915 A: Yes.
916
917 Q: So a total of 10 at least getting through the window?
918
919 A: Correct.
920
921 Q: Okay. Um, and then, um, after that happened, you take over and do another
922 volley?
923
924 A: Yes, we attempted to break out the windows in anticipation of, um, further,
925 um, because we had talked about trying, uh, expulsion grenades through the
926 window and we weren't going to do that if the windows were intact.
927
928 Q: Okay.
929
930 A: Um, so we fired a third volley, to assist in breaking the window as well as
931 introducing more agents.
932
933 Q: And you- you did that, right?
934
935 A: Yes.
936
937 Q: Okay. And were you successful in breaking the windows?
938
939 A: Yes, most of them.
940

941 Q: Okay, and that was five and five at least going through?
942
943 A: Yes.
944
945 Q: You don't know how many rounds are actually shot though?
946
947 A: Yes.
948
949 Q: Okay. Um, so after that occurs, is there still the surrender orders and things
950 like that going on?
951
952 A: Yeah, constantly.
953
954 Q: Okay. And what's the next thing that goes on?
955
956 A: Well, we decided to get EPD to, um, well, no, that was later. We, um, they
957 just Lieutenant (Caventa) had wanted us to throw so, um, grenades in through
958 the number 4, side, so CDC responded with a ballistic blanket and the five of
959 us, um, walked up to these windows and threw in some, uh, CS grenades.
960 One into each window.
961
962 Q: Okay. Explain to me the CS grenade.
963
964 A: Um, it's a non-burning, non-flammable, uh, continuous discharge, uh, it's a
965 cylindrical thing, maybe, I don't know about six to eight inches in length. It
966 appears and activates like a grenade. It has a pull-pin to release but there is
967 non-burning, so it's made for indoor use.
968
969 Q: Okay. And, um, is it the smoke grenades or is just the...
970
971 A: On, no, it's just a powder agent.
972
973 Q: Okay. And just like an aerosol type of thing?
974
975 A: Correct.
976
977 Q: Okay.
978
979 A: To smoke him out.
980
981 Q: Okay. And you guys go up under the CDC's blanket. How did the blanket
982 get to you guys?
983
984 A: Uh, CDC, um, there's some counter-snipers and I guess some members of the
985 CIRT Team approximately five or six of those guys responded down. They

986 provided lethal cover from the vehicles. Um, (Lasor) and I held the blanket
987 and (Jesse), (Barney) and, um, Brian (Quenell) provided cover. We walked
988 up and (Jamie Barney) activated his grenade and tossed them- one into
989 window A and one into window B.

990
991 Q: Okay. And did you guys return at that time then?

992
993 A: Yes, we retreated back tot the vehicles.

994
995 Q: Was the difference between those grenades just regular shooting those things
996 in there?

997
998 A: Uh, more agent for a longer period of time.

999
1000 Q: Okay. And you guys return to the vehicle, and- and what goes on next?

1001
1002 A: Well, then Lieutenant (Cayenta), uh, wanted EPD to introduce one to this side
1003 to assist in perhaps in maybe helping him to exit the residence, um, because
1004 we were still receiving no response from him at all. And they were still- the
1005 negotiations were still going on throughout. EPD refused, said it was too
1006 dangerous. So, we, um, responded up here. Um, CDC -- we were out of
1007 basically options at that point, out of munitions. CDC brought us a bunch of
1008 munitions down, um, a variety of stuff. I didn't actually look at the stuff was,
1009 but I now there was stuff- different things. There was smoke, um, CS cans,
1010 there was indoor use, pyrotechnics, there was all kinds of things. And, um, so
1011 they gave us this ballistic blanket and we again responded up for a second,
1012 um, lobbing, is that's what you want to call it.

1013
1014 Q: Okay. And what were the items that were tossed through the window at that
1015 time?

1016
1017 A: Uh, did not look at them. I could not tell you specifically. I was told -- we
1018 did not pick the pyrotechnics, um, anything that was meant for -- the- the one
1019 grenade that I believe was tossed, I was told was a tri-chamber, which is made
1020 for indoor use. It is a pyrotechnic technically, but it's a non-flammable
1021 pyrotechnic for indoor use.

1022
1023 Q: It- it- I've been told so far, it burns inside the can?

1024
1025 A: Yeah. That's why there's a tri -- there's three chambers to contain the flame
1026 inside the grenade so there's no fire danger. At our school, they put one in a,
1027 uh, in a trash basket full of papers. It singed the papers, um, but that was it. It
1028 would not start a fire.

1029
1030 Q: Okay, what's the name of that thing?

1031
1032 A: Tri-chamber.
1033
1034 Q: Tri-chamber.
1035
1036 Q1: And it's filled with CS?
1037
1038 A: Yeah, it's a CS smoke disbursal. And technically, it's a pyrotechnic, but it is
1039 a flameless pyrotechnic.
1040
1041 Q: Okay.
1042
1043 A: And gain, I was told that's what it was. I did not actually look at it and
1044 confirm it was. I was not involved in that part.
1045
1046 Q: Okay. Now who put it through -- you guys came up, I can't remember what
1047 you told me. Who...
1048
1049 A: Uh, we all came up again. (Lasor) and I were holding a blanket with, uh,
1050 (Jesse Taylor) Brian (Quenell), and (Barney) provided cover and, uh, (Barney)
1051 actually activated, um, pulled the pins on whatever was thrown. On the- that
1052 particular grenade, the tri-chamber, uh, bounced off of the center, vinyl
1053 portion of the window. We started backing away...
1054
1055 Q: (Unintelligible)?
1056
1057 A: Um, I believe it was B, but the grenade was over here so I'm not sure.
1058
1059 Q: Okay.
1060
1061 A: Um, we were looking- Sergeant (Quenell) was missing. I looked over and
1062 Sergeant (Quenell) is picked up the grenade that had missed and shoved it into
1063 window A.
1064
1065 Q: Okay. And was there anybody else that- was there anything else around at
1066 that time?
1067
1068 A: No, I believe there was one in each. Um, I don't know what the second
1069 munition was.
1070
1071 Q: Okay. Was that- now was that called the smoke CS type of thing? Tri-
1072 chambers?
1073
1074 A: Yes. It- the smoke, um, aids in the disbursal of the agent. So there is actual
1075 smoke associated with it. You could- we could see the smoke.

1076
1077 Q: Okay. Is that the- is that the white smoke...
1078
1079 A: Yeah.
1080
1081 Q: ...that everyone talks about?
1082
1083 A: Uh-huh.
1084
1085 Q: Okay. And you guys return back?
1086
1087 A: We return back, and we watched the progress on CDC maintained covering
1088 the house. And, we could see the smoke. We could see it activating. We
1089 could see him staying in the- in the room. Then, it eventually dissipated, and
1090 was completing gone.
1091
1092 Q: Okay. And still- still no response from...
1093
1094 A: Still no response.
1095
1096 Q: ...from the guy inside. What, uh, what happens next?
1097
1098 A: (Wayne) continued negotiations. Um, then, uh, one of the CDC guys said, oh
1099 the smokes starting up again. And we look, and, you know, it appears the
1100 smoke starting again. And the smoke begins to change colors, and we realize
1101 that's not our smoke. It appears to be a fire. Um, so (Mike Fidelity) gets on the,
1102 uh, PA and- and tells him, we believe there's a fire, you need to get out. And
1103 they started continuous negotiations from there on out trying to get him out of
1104 the house.
1105
1106 Q: Okay.
1107
1108 A: Advising him there's a potential fire in the house.
1109
1110 Q: And there's never a response from him?
1111
1112 A: Never a response from him.
1113
1114 Q: Okay. And, um, eventually do you see flames and stuff?
1115
1116 A: Yes.
1117
1118 Q: Okay. And eventually, the house becomes is...
1119
1120 A: Becomes fully engulfed, yeah.

1121
1122 Q: Okay. Um, from the time it's just smoking and the small flames begin, there-
1123 there's quite a while that passes through at that time, would you say?
1124
1125 A: Yes.
1126
1127 Q: Okay. And, um, in your mind, um, was- when you guys were putting in the
1128 gas, was it being effective at all?
1129
1130 A: Well, I- I figure it's working because he is making attempts to avoid it, such
1131 as hiding under the blanket. Um, so it's obviously in the air, but it's not
1132 effective to the point of where we're achieving our goals where he's wanting
1133 to get out of there.
1134
1135 Q: Right. And do you know some reasons why this would've- would've been
1136 ineffective or this particular one or reasons why that happened?
1137
1138 A: Uh, the smoke grenade?
1139
1140 Q: Any- when you guys are introducing the gas, sometimes, you know, why-
1141 why did...
1142
1143 A: Oh yeah.
1144
1145 Q: ...it's ineffective?
1146
1147 A: Well, he could've -- all he had to do is close the doors. And that- that
1148 minimizes the affect because we have, um, these windows weren't broken out,
1149 so there's not cross-breeze that's gonna take the agent over into this room or
1150 the bathroom where we believed he was hiding out between those two rooms.
1151
1152 Q: Okay.
1153
1154 A: And all he had to do is shut the door.
1155
1156 Q: Did- did it get fairly windy up there at one point?
1157
1158 A: It did.
1159
1160 Q1: Okay. If these windows were broken out, and these windows broken out,
1161 would that make a cross wind?
1162
1163 A: That would probably drive the agent into here, and it would also help him to
1164 clear out the house because wind is the best thing to get rid of it.
1165

1166 Q: Why didn't you guys put any, uh, gas rounds into the number 1 side?
1167
1168 A: Can't say.
1169
1170 Q: Okay.
1171
1172 A: Um, on the number 1 side, the windows were very small, and we would've
1173 had to get really close, um, which we really didn't want to do. We did not
1174 like- I didn't like going up here once, let alone twice, with a ballistic blanket.
1175
1176 Q: The number 1 side is fairly open, is that correct?
1177
1178 A: Yes. There's a long approach, there's zero cover, and then again, and this is
1179 turned more- more to here because the front door is more facing the driveway
1180 and there's a car there. And for us to approach, it's a long approach, there's-
1181 there's no cover, the windows are very small, and this was where EPD refused
1182 to- to take action.
1183
1184 Q: Okay.
1185
1186 A: They were doing it from approximately 85- I believe they're lobbing gas from
1187 85 feet back, which is just pushing the limits of, uh, the equipment.
1188
1189 Q: You- it was even pushing from where you were?
1190
1191 A: Yeah. It is not suggested. It's a- you can try, it's one of those things, and
1192 hope.
1193
1194 Q: See now, if I'm right, didn't someone mention 81 yards?
1195
1196 A: Eighty-one yards? I thought it was 81 feet. I could be wrong.
1197
1198 Q: Okay.
1199
1200 A: For EPD.
1201
1202 Q: And- and the same with your guys' position?
1203
1204 A: Well, yeah, you'd have to ask EPD. I thought they said- we understood it to be
1205 65 feet. But, yeah, you'd have to ask (Altec). He's the one that actually took
1206 the measurement and I got it like second-hand.
1207
1208 Q: Okay.
1209
1210 A: 'Cause I put it- eye-balling it, I put it at 75 yards, so.

1211
1212 Q1: When I eye-balled it, I put it at 50, so...
1213
1214 A: Okay.
1215
1216 Q1: I mean, the 65 feet or whatever, I mean that's real close, so I was just
1217 clarifying.
1218
1219 A: Yeah, maybe I'm just FUBAR on my, uh, feet and yards.
1220
1221 Q: Okay.
1222
1223 A: At this point.
1224
1225 Q: Um, during this time that you were there, I've been hearing mention that there
1226 was a fireplace. Did you ever see smoke coming out of the chimney or
1227 anything like that?
1228
1229 A: I didn't.
1230
1231 Q: Okay.
1232
1233 A: Of course, I wasn't watching.
1234
1235 Q: No. And then when the orders were coming for gas and things like that, were-
1236 were they mainly coming from Sergeant (Quenell) through Lieutenant
1237 (Caventa) as far your understanding?
1238
1239 A: I could hear (Caventa) on the radio also giving the order to- to...
1240
1241 Q1: Another volley or something like that? Okay.
1242
1243 A: To initiate.
1244
1245 Q: And, um, was- was there ever a mention about pyrotechnics on the house?
1246
1247 A: Yes, by the CDC. They said, here's the pyrotechnic, but that would probably
1248 burn the house down. We said we don't want to use that. We don't want to
1249 burn the house down.
1250
1251 Q: Who was we?
1252
1253 A: Uh, Sergeant (Quenell).
1254
1255 Q1: Okay. And he advised he didn't...

1256
1257 A: I don't know who made the specific decision, but (Barney) was gonna be the
1258 one lobbing it and he and (Quenell) were talking. You'd have to ask them.
1259
1260 Q1: Okay.
1261
1262 A: Um, but the decision was made and the pyrotechnic was left in the vest on the
1263 tailgate of the second vehicle.
1264
1265 Q: Okay. And when did you come back from the gas school, Brian?
1266
1267 A: It's been a few months, probably three months ago.
1268
1269 Q: Okay.
1270
1271 Q1: But it's all pretty fresh to you in your mind?
1272
1273 A: Yes.
1274
1275 Q1: Explain to me the 37 mm ferrets. When they- what are they supposed to do?
1276
1277 A: Well, they're made for penetrating barricades, essentially. Um, they penetrate
1278 and disburse powder or liquid agent depending on the type of ferret.
1279
1280 Q1: And so, ideally, if you're within those feet, it can go through a house or
1281 window?
1282
1283 A: Ideally.
1284
1285 Q1: And it busts up inside?
1286
1287 A: Right.
1288
1289 Q1: Okay. How does it come apart in there? How does it work?
1290
1291 A: Well, it hits a hard- hard surface, which essentially breaks- breaks it open and
1292 the agent is disbursed.
1293
1294 Q1: Okay. And, uh, what about the shotgun ferret rounds?
1295
1296 A: Same- same deal.
1297
1298 Q1: Okay, do you guys use all CS?
1299

1300 A: Uh, no we had OC, um, we didn't have a lot of OC with us at that particular
1301 event, but I use OC, uh, shotgun ferret rounds to try to do something different,
1302 because the CS was obviously not working.

1303
1304 Q1: Okay.

1305
1306 A: We also threw a few CN in there because we had them.

1307
1308 Q1: Okay.

1309
1310 Q: The shotgun ferret ones?

1311
1312 A: Uh, no those were actually 37 mm. There were actually four of 'em.

1313
1314 Q1: Okay. And are those stronger than CS or- explain those to me?

1315
1316 A: No, the CS is actually stronger.

1317
1318 Q1: Okay. What's the difference between the two?

1319
1320 A: Well, the CN is like five times more toxic and five times less effective.

1321
1322 Q1: Okay.

1323
1324 A: But essentially we were out of the CS rounds.

1325
1326 Q1: Okay.

1327
1328 Q: And the shotgun ferret rounds that you fired are CS rounds?

1329
1330 A: Yes.

1331
1332 Q: Okay.

1333
1334 A: And OC.

1335
1336 Q1: And OC. So there was a mixture of both.

1337
1338 A: Yes.

1339
1340 Q: Okay, what's the effective range of shooting those out of the shotgun?

1341
1342 A: Fifty yards is the standard.

1343
1344 Q1: Even with that?

1345
1346 A: Yes.
1347
1348 Q1: Okay. And they're much smaller than...
1349
1350 A: (Unintelligible) agent.
1351
1352 Q1: Okay.
1353
1354 A: So one of those is probably equal to, uh, five or six of those might come close,
1355 I figure .15 or something as opposed to, uh, 15. gallons, I'm not sure.
1356
1357 Q1: Okay.
1358
1359 A: It's a lot less.
1360
1361 Q1: Okay.
1362
1363 Q: In um, as far as, um, did- was there, I don't know, the sting ball or whatever
1364 it's called?
1365
1366 A: Yeah, there was talk of that. I don't know what was deployed, though.
1367
1368 Q1: Okay. So something was deployed along with, whatever you call it, the tri...
1369
1370 Q2: Tri-chamber.
1371
1372 Q1: Tri-chamber?
1373
1374 A: Tri-chamber, yes.
1375
1376 Q1: The smoke one.
1377
1378 A: There was a second, um, it may have been a blast ball. I'm not sure. There's
1379 was talk- they were talking about the different munitions and one of those was
1380 in the jacket, um, or available.
1381
1382 Q1: Okay.
1383
1384 A: I don't know if it was deployed or not. And that was just something that had
1385 OC along with, um, stinger balls in it.
1386
1387 Q1: Okay. And you mention a jacket. What do you mean by a jacket?
1388

1389 A: The CDC, uh, sergeant or whatever he was, brought down um, a technical
1390 munitions vest that has different pockets with a whole bunch of munitions in
1391 it.
1392

1393 Q1: Okay. He burned- those rounds that were used, do you have any left over here
1394 at the office?
1395

1396 A: Yes. Um, we don't have any of the 37 mm CS, uh, ferret powder ones. We
1397 only have a few of those and those are the most accurate. We used those up.
1398

1399 Q1: Okay.
1400

1401 A: We have some of the CS, uh, liquid 37 mm, and we have a bunch of the
1402 shotgun ferret of both types.
1403

1404 Q1: And all those were used?
1405

1406 A: Yes.
1407

1408 Q1: Okay.
1409

1410 Q: Back to when- when you returned fire, Brian, um, you- you were crouched
1411 down in the door when the round was fired?
1412

1413 A: Yes.
1414

1415 Q: When the two rounds were fired?
1416

1417 A: Yes.
1418

1419 Q: And did you immediately -- you had your gun focused on the house at that
1420 time?
1421

1422 A: My gun was in the door. I wouldn't say it was pointing directly, you know.
1423

1424 Q: Right.
1425

1426 A: Because I can't maintain that position for very long without my muscles tiring
1427 out. It was resting on- at the, uh, intersection of the door, in the door jam, in
1428 the front of the door jam, um, and I'm watching.
1429

1430 Q: And then you see the barrel come out?
1431

1432 A: Yes.
1433

1434 Q: Pointing at you and shoot the two rounds at you?
1435
1436 A: And it happened very quickly.
1437
1438 Q: And you're- you're thinking you radioed shots fired in between rounds?
1439
1440 A: Well, as soon as- it's like the gun came out, boom, and immediately I flinched
1441 and took cover, and I radioed shots fired. A second shot comes off. Then fire
1442 back, he goes in and I radio again, shots fired, shots fired. Advising I returned
1443 fire.
1444
1445 Q: Okay. And that was the A window, number 4?
1446
1447 A: Yes.
1448
1449 Q: Okay. And did you have a site picture on the window?
1450
1451 A: When I fired?
1452
1453 Q: Yes.
1454
1455 A: Yes.
1456
1457 Q: Okay. And was anyone standing in that window when you fired?
1458
1459 A: I could not see a person.
1460
1461 Q: Okay.
1462
1463 A: I could see the barrel.
1464
1465 Q: You could still see the barrel?
1466
1467 A: I believe he took -- because this windows divided in half, and there's
1468 something like a bed here, which- or a bunk-bed or something, I could never
1469 tell what it was. The barrel's coming out of the edge of this slider. This was
1470 open, the barrel's coming out right here. And it appears he's trying to
1471 maintain cover, um, and because it's dark all- it's dark all back in there, you
1472 could only see these shelving on this side, and it's dark in there. So, I, um, put
1473 my site in the direction of the barrel.
1474
1475 Q: Okay. And during the- did- did you ever hear any other rounds or anything
1476 like that later on when the fire started?
1477
1478 A: Yes. It sounded like, uh, rounds cooking off.

1479
1480 Q: Okay. Like fireworks? And did you ever take your handgun out?
1481
1482 A: No.
1483
1484 Q: You didn't. Okay. Um, are you- are you trained on- on your rifle?
1485
1486 A: Yes.
1487
1488 Q: Okay. And are you trained- do you qualify with it?
1489
1490 A: Yes.
1491
1492 Q: Okay. And also with the SET Team, do you also qualify with that?
1493
1494 A: Yes.
1495
1496 Q: Um...
1497
1498 A: We shoot every other training.
1499
1500 Q: And with that, is your training documented?
1501
1502 A: I believe so.
1503
1504 Q: Okay.
1505
1506 Q1: Let's see. Um, just a few for you here, Deputy. You carry an M-16?
1507
1508 A: Yes.
1509
1510 Q1: What kind of- do you have a scope or what kind of sites do you have on that?
1511
1512 A: Uh, it's a medical.
1513
1514 Q1: Um, describe that to me.
1515
1516 A: In, uh, well it's- it's not a scope per se. It's something that allows you to fire
1517 your weapon from any angle without having to looking directly down the
1518 sites. Um, so that you don't have to maintain it up at the ready position, but
1519 you can look through it, essentially it's not a scope because it doesn't magnify
1520 anything. The closest thing that I can describe it as is, uh, sort of like the laser
1521 pointer thing whatever that triangle is is what you're firing at.
1522
1523 Q1: So what you see through that is a triangle?

1524

1525 A: Yes, it's a very small orange triangle.

1526

1527 Q1: Is that gun assigned to you and that's what you use?

1528

1529 A: Yes.

1530

1531 Q1: At some point in time, you talk about, um, you heard some screaming, yelling.
1532 You could hear him sometimes say different things. Do you remember
1533 specifically any quotes that he said or the things that you could understand?

1534

1535 A: Uh, just that, "You guys need to back the fuck outta here." Um, I'm not sure
1536 if it was, "I'm gonna cap you all" or "I'm gonna start capping off at you." He
1537 said "I'm gonna go get my M-16" or that- clearly that was when he was in the
1538 window. Um, and that's pretty much all the specifics that I could understand.

1539

1540 Q1: Um,..

1541

1542 A: You know he said, "I'm not going back to (SD)."

1543

1544 Q1: He did ay that?

1545

1546 A: Yes.

1547

1548 Q1: You said this is kind of off to you from your angle?

1549

1550 A: Yes.

1551

1552 Q1: What...

1553

1554 A: This angle, this should be...

1555

1556 Q1: Can you draw a line on this diagram of the number 4 side, and just put the
1557 ends on it to kind of how you remember that house being to you.

1558

1559 A: We'll assume the distance is correct, but I would angle it out more this
1560 direction. Because this number 2 side from here, should be more up here.

1561

1562 Q1: Okay.

1563

1564 A: And then the front door would be like something like that . More like this
1565 angle. But for the parts, we had a better.

1566

1567 Q1: That gives me an idea of what that remembers that being. And then, at this
1568 point in time, you have initials here where you put on this first vehicle, it
1569 looks like Hoop Valley Tribal Police vehicle.
1570
1571 A: Yes.
1572
1573 Q1: As, throughout this incident, there's negotiations you mention going on,
1574 where were those people in relations to you?
1575
1576 A: Uh, most of the negotiations was going on from this second uh, Tribal unit.
1577
1578 Q1: You mentioned, uh, Sergeant (Fidley) from the Sheriff's Office um, who else
1579 do you remember doing negotiations?
1580
1581 A: Um...
1582
1583 Q: (Jason)?
1584
1585 A: (Jason Daniels) was up there with him for some time. He talked down there
1586 um, the guy kept who saying it was (Tony) from the Sheriff's Department but
1587 he was actually a CDC. He was wearing a, um, CIRT Team uniform. Um, he
1588 kept saying this is (Tony) from the Sheriff's Department, we're to help you
1589 Um, he was there for a while on the, uh, second morning, Monday morning. I
1590 don't know his name, though.
1591
1592 Q1: Other than (Tony)?
1593
1594 A: Yeah.
1595
1596 Q1: Okay. Um, at some point in time, you talk about some different volleys going
1597 off, um, or being deployed with gas, and you mentioned Deputy (Barney) had
1598 deployed some what you referred to as bad stuff. What- what do you mean by
1599 that and what was that or what point was that?
1600
1601 A: Um, I believe it was in the third 37 mm volley. We had attempted to introduce
1602 some OC, since we were receiving no response- response from the CS. And
1603 he shot it, and, uh, the gas was not making it even to the window. It was
1604 petering out and exploding in the yard, and we were being coated by the OC.
1605
1606 Q1: Okay. By bad stuff, that would mean...
1607
1608 A: A dud.
1609
1610 Q1: Okay.
1611

1612 A: That's what I'd call it.
1613
1614 Q1: So the 37 mm, was actually not working at all. It was getting into the house?
1615
1616 A: It wasn't making it to the house even.
1617
1618 Q1: How many of those were deployed?
1619
1620 A: Two or three. And then we- after that one exploded on us, we got rid of those
1621 rounds and didn't try anymore.
1622
1623 Q1: And that particular type of round, was that the first time that that was used?
1624
1625 A: Yes.
1626
1627 Q1: You talk about some of the 12 gauge ferret rounds, um, is- is it similar to a
1628 shotgun when you shoot a 12 gauge ferret round. Is there a shell casing that
1629 pops out, is there a wad, is there a...
1630
1631 A: Yes.
1632
1633 Q1: Were those all left in the area?
1634
1635 A: Yes, we did not retain any of the spent- spent cartridges.
1636
1637 Q1: You made a comment that was, you know, it was hard for you to remember
1638 and that's understandable, how many of what was taking, so whatever
1639 would've been used should be on the scene.
1640
1641 A: Um, correct. It was all on the ground right there. It was stepped on and
1642 kicked around quite a bit, but it should've all been there.
1643
1644 Q: Real quick, did- did you ever pick up your shell casing from your M-16?
1645
1646 A: No.
1647
1648 Q1: And, at some point there was, uh, you refer to it as a grenade-type
1649 deployment, um, of a non- burning, un-flammable type smoke. Was it CS or
1650 OC?
1651
1652 A: It was CS.
1653
1654 Q1: Would that have been the first time you guys approached this with that
1655 ballistic blanket that you refer to.
1656

1657 A: Yes.
1658
1659 Q1: Um, tell me about that particular grenade. Um...
1660
1661 A: That's the one I was talking about. It was black, it's cylindrical, it's um,
1662 maybe an inch, inch-and-a-half in diameter, maybe six to eight inches tall, um,
1663 it releases -- it's a grenade type thing, like a M201A1 fuse, where you pull just
1664 like our flash-bang. You pull, uh, you pull a pin, you release it, except there's
1665 no- it's not pyrotechnic at all.
1666
1667 Q1: Now was that property of the Sheriff's Department?
1668
1669 A: Yes, and we have more of those, uh, in the trailer.
1670
1671 Q1: Okay. And there was a second deployment as well. And that- that was the one
1672 that sounds like it might have hit the side of the building and falls there?
1673
1674 A: Yeah, during the second, uh, ingress, yeah.
1675
1676 Q1: And what was that? Was that the same exact type of grenade or a different
1677 type?
1678
1679 A: That's the one that I don't know what they brought. I don't know what they
1680 throw. All I know is the one grenade that was a smoke grenade, the non-
1681 pyrotechnic that- that was told me was a tri-chamber.
1682
1683 Q1: That was the tri-chamber. And that was the one that Sergeant (Quenell) from
1684 the Sheriff's Department picked up and threw it back in the window...
1685
1686 A: Right.
1687
1688 Q1: ...because it had missed?
1689
1690 A: Right. And there was another, um, munition deployed. I don't know what-
1691 what it was.
1692
1693 Q1: Uh, on that second deployment as well?
1694
1695 A: Yes.
1696
1697 Q1: Just prior or after?
1698
1699 A: Just prior or after to what?
1700

1701 Q1: Um, the second deployment as you're approaching with that ballistic blanket.
1702 You said there was another?
1703

1704 A: Yeah, there was two total. On the second one was when the grenade was
1705 thrown and bounced off. But there was one that was meant to go in the A
1706 window and one that was meant to go in B window. So, on the second, um...
1707

1708 Q1: Attempt.
1709

1710 A: ...approach.
1711

1712 Q1: Okay.
1713

1714 A: Two munitions were deployed, one of which was the smoke grenade, um, the
1715 tri-chamber. And I cannot tell you what the second munition was. And I
1716 cannot even guarantee you that the, uh, tri-chamber was actually a tri-chamber
1717 'cause I did not see it. I was not involved in the decision to use that. That
1718 was between Sergeant ((Quenell)) and, uh, Deputy (Barney).
1719

1720 Q1: And of those two, those were both not, as far as you know, um, property of the
1721 Sheriff's Department?
1722

1723 A: No. They were property of the CDC.
1724

1725 Q1: Um, the blast ball. Is that something you guys carry? You refer to a blast
1726 ball. What is that?
1727

1728 A: It's something I want to get. Um, there's various types. There's stinger balls
1729 which just release like 60,000 pellets. I mean, you can stand there, they use
1730 them in the prisons a lot. They're for crowd control. Blast balls- they're balls
1731 that, um, that explode and essentially throw out OC, and then there's balls
1732 that, um, explode and- and disburse OC powder agent, as well as, um, the
1733 stinger balls. I believe that's what a blast ball is.
1734

1735 Q1: And do you know if those are used?
1736

1737 A: I do not believe so.
1738

1739 Q1: Okay.
1740

1741 A: Again, I don't know what the second munition was.
1742

1743 Q1: Okay. That's all I have.
1744

1745 Q: Okay, Brian, that, you- you heard those- those rounds that came from the
1746 house. Did they appear to you to possibly be from the same, um, gun?
1747
1748 A: You mean, that...
1749
1750 Q: The shots fired...
1751
1752 A: ...the first time he shot at me versus the second volley? Yes.
1753
1754 Q: Okay.
1755
1756 A: They're kind of, you know, I have .22 rotor for a long time, so it sounded like
1757 that.
1758
1759 Q: Okay.
1760
1761 A: A high-pitched crack.
1762
1763 Q: Okay. And when you guys were up here stationed at the Yurok vehicle, could
1764 you clearly hear the negotiators, uh, from behind the Tribal vehicle?
1765
1766 A: Yes.
1767
1768 Q: Okay. Um, I don't have anything else. Um, Brian, is there anything that we
1769 haven't asked you think would be important for us to know about the
1770 incident?
1771
1772 A: Mm, not -- I think that's pretty much all of it.
1773
1774 Q: Okay. [REDACTED], you got anything?
1775
1776 Q2: No questions, thank you.
1777
1778 Q: Alright. We'll end the interview at 1022 hours. (Unintelligible).
1779
1780

1781 This transcript has been reviewed with the audio recording submitted and it is an accurate
1782 transcription.

1783 Signed _____



Humboldt County Sheriff's Office Criminal Investigation Division Supplemental Report

CASE: 200703162

INVESTIGATOR: M. Kirkpatrick

DATE: 06-04-2007

CRIME: Attempted murder - Officer involved shooting

VICTIM: State of California

SUSPECT: [REDACTED]

LOCATION: [REDACTED] property Hoopa [REDACTED]
Residence GPS latitude [REDACTED] longitude
[REDACTED] [REDACTED].

[REDACTED] Deceased: [REDACTED] date of birth [REDACTED]
[REDACTED]

Witness: [REDACTED] [REDACTED]
[REDACTED] Hoopa - [REDACTED] [REDACTED] - cell
[REDACTED].

On 06-03-2007 around 1935 hours, I received a telephone call from Sergeant W. Hanson, Humboldt County Sheriff's Office Criminal Investigations Division, Sergeant Hanson told me Humboldt County Deputy Sheriff Detectives R. Schlesinger and S. Quenell were called out to the Hoopa area regarding a male [REDACTED] (who was later identified as [REDACTED]) who fired at law enforcement personnel and a deputy from this office returned fire. Sergeant Hanson asked me if I would be available to assist him on 06-04-2007 if needed on the investigation (Critical Incident Response Team). I told Sergeant Hanson I would be

available. Sergeant Hanson told me he would telephone me on 06-04-2007 if I was needed.

On 06-04-2007 around 0620 hours, I received a telephone call from Sergeant W. Hanson, Humboldt County Sheriff's Office Criminal Investigations Division. Sergeant Hanson told me I was needed to assist him in the Hoopa area and to meet him at the Humboldt County Sheriff's Office Main Station Eureka. Sergeant Hanson told me we would ride up together to the Hoopa area.

Around 0710 hours, I arrived at the Humboldt County Sheriff's Office and met with Sergeant Hanson.

Sergeant Hanson and I traveled to the Hoopa area. Prior to leaving the Eureka area we were asked to attempt to meet [REDACTED] mother ([REDACTED]) at the Humboldt County Sheriff's Office Hoopa Sub-Station and she was going to show us where [REDACTED] residence is and her other son [REDACTED] was at so we could talk with him.

Around 0857 hours, we met with [REDACTED] at the Hoopa Sub-Station. [REDACTED] took us to the Masten Flat Property off Pine Creek Road. On this property there is several family member's residences. [REDACTED] took us at the end of the driveway and the last road on the right leads to her son's ([REDACTED]) residence. [REDACTED] told us [REDACTED] has been living in the trailer for several months now.

Sergeant Hanson and I exited his vehicle and looked at the residence (trailer). It was a single wide mobile home and I asked Sergeant Hanson to get a GPS reading on this location because Detective B. Nord was at his office in Eureka and writing a search warrant for this residence along with the residence [REDACTED] was held up in on [REDACTED] property Hoopa ([REDACTED] Residence GPS latitude [REDACTED] [REDACTED] longitude [REDACTED]). The GPS reading for [REDACTED] residence is latitude [REDACTED] longitude [REDACTED].

After obtaining this information. I telephoned and talked with Detective Nord. I gave Detective Nord the directions, description, and GPS reading to [REDACTED] residence.

[REDACTED] told us [REDACTED] was at his Aunt's residence just below [REDACTED] residence. Sergeant Hanson and I went to this

residence on Masten Flat. At the residence we met with [REDACTED] and Sergeant Hanson obtained a statement from [REDACTED] see Sergeant Hanson's supplemental report for [REDACTED] statement.

After talking with [REDACTED] Sergeant Hanson and I went to [REDACTED] residence off Shoemaker and Moon Lane to attempt to obtain a statement. Upon our arrival at the residence we found [REDACTED] was not at home.

Sergeant Hanson and I went to the incident command post to wait for further instructions and the search warrant. At the incident command, I met with Detective Schlesinger and he asked me if I would execute the search warrant at [REDACTED] residence, the residence where [REDACTED] was held up in, and attempt to locate and interview [REDACTED]. I told Detective Schlesinger that I would execute the search warrant at [REDACTED] residence, attempt to locate [REDACTED] and execute the search warrant at the residence [REDACTED] is held up in once the situation was over and secure.

Around 1212 hours, I received a telephone call from Detective Nord. Detective Nord told me a search warrant and Ramey warrant of arrest was signed Humboldt County Superior Court Judge T. Cissna. Detective Nord told me the search warrant was for [REDACTED] residence (GPS reading for [REDACTED] residence is latitude [REDACTED] longitude [REDACTED]) and the residence [REDACTED] was hold up in ([REDACTED] Residence GPS latitude [REDACTED] longitude [REDACTED]). Detective Nord told me the Ramey warrant of arrest was for [REDACTED] for attempted murder.

I stood by at the incident command until Eureka Police Department Detective K. Lawson to arrive. Once Detective Lawson arrived we were going to [REDACTED] residence to execute the search warrant.

Around 1410 hours Detective Lawson and I arrived at [REDACTED] residence (latitude [REDACTED] longitude [REDACTED]). Also at the residence was Humboldt County Sheriff's Office Evidence Technician [REDACTED]. Technician [REDACTED] was at the residence to assist us with taking digital photographs, videotaping, search, and evidence collection.

Prior to executing the search warrant, Technician [REDACTED] took digital photographs and videotaped the outside of [REDACTED] residence.

After digital photographs were taken, I went to the front door and gave knock notice "Sheriff's Office, Search Warrant, Open the door". No one came to the door. Upon looking at the front door it looked like it was partly cracked open. I checked the doorknob and found it unlocked and pulled the front door opened. Detective Lawson and I entered the residence to secure it. Once inside the residence I yelled out several times "Sheriff's Office, Search Warrant" and still didn't get a response. The residence was secured and no one was found in the residence.

Once the residence was secure, Technician [REDACTED] took digital photographs of the inside of the residence prior to searching. After digital photographs were taken Technician [REDACTED] videotaped the outside and inside of the residence prior to searching the residence.

Once Technician [REDACTED] was done with taking digital photographs and videotaping we conducted a search of the residence.

In the residence I found on the kitchen table seven (7) empty prescription bottles for [REDACTED] and indicia for [REDACTED]. These bottles were dated in 2006. On the top shelf of the bedroom I found a bowl containing miscellaneous live firearm ammunition and indicia for [REDACTED].

Technician [REDACTED] seized all these items and she is going to book them into evidence. See Technician [REDACTED] supplemental report for her involvement and items of evidence seized.

I filled out a search warrant inventory form on these items sized from [REDACTED] residence. I left a copy of this inventory form along with a copy of the search warrant in [REDACTED] residence. We left [REDACTED] residence around 1510 hours.

After serving the search warrant at [REDACTED] residence, Detective Lawson and I went to the residence just below [REDACTED] residence on Masten Flat and met with [REDACTED].

We met with [REDACTED] [REDACTED] (date of birth [REDACTED]) [REDACTED] and he told us he lives at this residence with his mother. I told [REDACTED] we were at the residence to talk to him regarding [REDACTED] [REDACTED] told us he would be willing to talk with us.

I digitally recorded our interview with [REDACTED] and later placed the recording onto a CD-R disc (Exhibit LM-1). I later booked this disc into evidence.

The following is a summary of [REDACTED] statement, see disc for [REDACTED] full statement.

[REDACTED] told us he knows [REDACTED] [REDACTED] is his first cousin, and they are real good friends. [REDACTED] told us [REDACTED] lived there and grew up there and has known [REDACTED] since he was a little kid. [REDACTED] told us [REDACTED] [REDACTED] [REDACTED] for the past few months. [REDACTED] told us in the last five years [REDACTED] has had these types of episodes routinely when Tribal Security is called and an ambulance. [REDACTED] told us when [REDACTED] doesn't [REDACTED] he loses it and doesn't know reality and doesn't know the difference. [REDACTED] told us when [REDACTED] is confronted with hostile stuff like this he will only project they are going to kill him and there is nothing that is going to change his mind back.

[REDACTED] told us five days ago the ambulance took [REDACTED] [REDACTED] [REDACTED]. [REDACTED] told me he went to town on Friday (06-01-2007) and usually when they let [REDACTED] out he calls him to pick him up. [REDACTED] told us he didn't receive a telephone call from him yet. [REDACTED] told me when he was going out to town he was going to check on [REDACTED] [REDACTED] told us when he checked on [REDACTED] they would not tell him anything because he was not immediate family. [REDACTED] told me on his way back home he stopped at the Blue Lake Casino. [REDACTED] told us while at the casino he telephoned his residence to tell his mother that they would not tell him any information about [REDACTED] [REDACTED] told us his mother told him he ([REDACTED] was there at her house now and for him to hurry up and get home. [REDACTED] told us he told his mother he would get right home.

[REDACTED] told us when he arrived back at home [REDACTED] was still in the same state of mind when they arrested him. [REDACTED]

told us [REDACTED] was just like he always is, his episodes, talks off the wall, and [REDACTED]

[REDACTED] told us how he knows [REDACTED] has [REDACTED] [REDACTED] he knows [REDACTED] and lives right there (on same property), he knows how [REDACTED] acts when [REDACTED], showing up at early hours in the morning, and when he sees this he tells [REDACTED] that he will take him to the hospital because [REDACTED]

[REDACTED] told us when he came home and saw [REDACTED] at his residence he asked [REDACTED] how he got there. [REDACTED] told us [REDACTED] told him he didn't know who brought him there. [REDACTED] told me after talking with [REDACTED] he left the residence and thinks [REDACTED] went to his residence.

[REDACTED] told us on Saturday (06-02-2007) [REDACTED] showed up at his residence in the morning. [REDACTED] told us [REDACTED] wanted him to take him up to [REDACTED] house [REDACTED] on Bald Hills. [REDACTED] told us he told [REDACTED] he could not take him to the residence and [REDACTED] said that he would walk there. [REDACTED] told us when [REDACTED] showed up he had on a lot of clothes on. [REDACTED] told us he later saw [REDACTED] and [REDACTED] asked [REDACTED] if he has seen [REDACTED] [REDACTED] told us [REDACTED] told him he has and he dropped him off at Shoemaker and he doesn't know how he end up back here (his residence).

[REDACTED] told us he didn't know what was going on up the hill until he received a telephone call from another person telling him it was [REDACTED] up on the hill.

[REDACTED] told us the last time he saw [REDACTED] was on Saturday morning.

[REDACTED] told me he has not personally seen [REDACTED] with any firearms but he had a little .22. [REDACTED] told us he doesn't know if it was rifle or not. [REDACTED] relative said it was a rifle but someone took it.

[REDACTED] told us in the past he knew [REDACTED] [REDACTED] and that was around five years ago. [REDACTED] told us he knows [REDACTED] [REDACTED].

After our interview with [REDACTED] we drove to the incident command.

Upon our arrival at the incident command we found out the residence [REDACTED] was held up in was on fire and fully engulfed. Fire personnel were attempting to put out the fire.

At the residence, I met with Detective Schlesigner and he told me that I would still be the one to execute the search warrant at this residence. Detective Schlesigner told me I was probably not going to be able to execute the search warrant on the residence until the morning hours of 06-05-2007.

While the fire personnel were putting out the fire, they had to cut a hole in the wall of the residence that lead into the bathroom. On the bathroom floor they saw a nude male's body in a fetal position on the bathroom floor. The male was deceased.

Technician [REDACTED] took digital photographs and videotaping the outside of the residence and residence on fire. Technician [REDACTED] took digital photographs of the male's body in the bathroom. Technician [REDACTED] also videotaped the male's body in the bathroom of the residence.

The fire department had knocked the fire down and continued to put water on the fire to keep it from catching back on fire. After the fire was knocked down Detective Schlesigner told me to get the body removed from the residence and to contact the Coroner for that.

I telephoned our communications center around 1653 hours and asked them to contact the Coroner and requesting they respond for the body. Around 1657 hours, I heard over my departmental radio 11-K-4 was en route (Deputy Coroner C. Van Buskirk) to my location for the body.

Around 1848 hours, the fire department stopped putting water on the residence.

Around 1851 hours, Deputy Coroner Van Buskirk arrived at the residence to remove the body. Technician [REDACTED] and Deputy Coroner Van Buskirk took digital photographs prior to the body being removed and after the body was removed from the residence. Around 1930 hours Deputy Coroner Van Buskirk removed the body from the residence.

After the body was removed the residence was still too hot to search and it was decided to have the Arson Task Force respond on 06-05-2007 for an investigation to see if they could determine a cause and origin of the fire. I was advised the Arson Task Force was going to be at the residence around 0800 hours on 06-05-2007.

Sergeant Hanson told me Sergeant Buihner, Deputy [REDACTED] and he were going to stay on the residence property for security all night and I was to return on 06-05-2007 at 0800 hours to finish up the execution of the search warrant with Technician [REDACTED]. Sergeant Hanson told me Arson Task Force was expected to arrive at the same date and time so they could start their investigation.

Technician [REDACTED], Detective Lawson, and I left the scene and headed back to Eureka. The scene was left with Sergeants Hanson, Buihner, and Deputy [REDACTED]

On 06-05-2007 around 0630 hours, I met with Detective Lawson and Technician [REDACTED] at the Humboldt County Sheriff's Office Eureka. We then drove over to the Hoopa Area. Once in Hoopa we waited for the Arson Task Force to arrive so we could show them the location. Once the Arson Task Force Arrived we drove back to the location (Moore/Brown Residence GPS latitude north [REDACTED] [REDACTED]).

Around 0833 hours we met with Sergeants Hanson, Buihner, and Deputy [REDACTED]. We relieved them and took over the scene.

Arson Task Force Members present were Humboldt County Sheriff's Office Deputy D. Diemer, Arcata Fire Department D. White and Eureka Fire Department J. Nicklas. Arson Task Force Members were told they could start their investigation after Technician [REDACTED] took more digital photographs and videotaped the scene.

While Arson Task Force Members were conducting their investigation Technician [REDACTED] and I collected items of evidence outside of the residence and from law enforcement vehicles left at the scene.

Technician [REDACTED] took digital photographs of the items of evidence prior to removing them. The following area items of evidence located and seized outside of the residence: 27

expended 37mm gas shells (roadway next to Hoopa Tribal Police vehicle California license [REDACTED], 21 expended 12 gauge barricade projectiles (inside front seat area of Hoopa Tribal Police vehicle California license [REDACTED], 6 12 gauge expended barricade projectiles (roadway next to Hoopa Tribal Police vehicle California license [REDACTED], 1 expended .223 shell (collected by Technician [REDACTED] on 6-4-07 - roadway next to Hoopa Tribal Police vehicle California license [REDACTED], 1 expended .223 shell (collected by Technician [REDACTED] on 6-4-07 - roadway next to Hoopa Tribal Police vehicle California license [REDACTED], 1 expended .223 shell (collected by Technician [REDACTED] on 6-4-07 - roadway next to Hoopa Tribal Police vehicle California license [REDACTED], 1 9mm sems round expended (collected by Technician [REDACTED] on 6-4-07 - roadway next to Humboldt County Sheriff's Office Vehicle operated by Deputy B. Taylor), 1 expended .223 shell (collected by Technician [REDACTED] on 6-4-07 - roadway next to Humboldt County Sheriff's Office Vehicle operated by Deputy B. Taylor), CS projectile (east side of residence), gun magazine - empty (under south east corner of residence), CS projectile (east side of residence), CS projectile (south side of residence), 1 12 gauge barricade projectile (south of residence), 1 12 gauge barricade projectile (south of residence), 1 12 gauge barricade projectile (south of residence), 1 expended 37mm gas projectile (south of residence), 1 expended .45 caliber shell (south of residence), 1 pin to chemical agent container (south of residence), 1 pin to chemical agent container (south of residence), 1 spoon to chemical agent container (south of residence), 1 CS 37mm projectile (south west of the residence), 1 expended .22 caliber LR shell (front of residence near steps), 1 37mm CS projectile (placed in can - under dark blue Ford thunderbird in driveway), 1 live 37mm CS projectile (placed in can - north side of residence), 1 expended .22 caliber shell (north of residence), 1 live 37mm CS projectile (placed in can - north of residence), 1 live 37mm CS projectile (placed in can - north of residence), 1 live 37mm CS projectile (placed in can - north side of residence), 1 expended 37mm CS projectile (north of residence), 1 live 37mm CS projectile (placed in can - north of residence), 1 live 37mm CS projectile (placed in can - north of residence), 1 live 37mm CS projectile (placed in can - north of residence), 1 expended CS projectile (north of residence), 1 expended .45 caliber shell (north of residence), 1

expended .45 caliber shell (north of residence), 3 expended .45 caliber shells (north of residence), 1 live 37mm CS shell (found on property in driveway), 1 expended 37mm CS projectile (south of residence), 20 expended 37mm CS shells (north east of residence), and 1 expended and two live CS 37mm projectiles (placed in can - outside north wall).

The following items of evidence located and seized are from inside the residence: 1 .45 caliber expended shell and 5 expended .223 shells (inside of residence east wall dining room area), 1 machete blade (south east corner of residence), 1 spent chemical agent gas canister (dining room), 1 empty gun magazine (dining room), 5 firearm barrels, 4 knives, 1 round grenade body, 1 sword, and 6 empty gun magazines (living room floor near west wall), 1 Spring Armory 1911-A1 .45 caliber stainless semi-automatic pistol serial number [REDACTED] (magazine loaded with 7 round and none in chamber - located on top of toilet tank), 1 spent chemical agent gas canister (south west bedroom), 1 expended CS projectile (master bedroom), large knife (kitchen area) and red short sleeve and red shorts (bathroom floor).

During the evidence collection outside the residence I saw two Hoopa Tribal Police vehicles parked south of the residence. One was a white Ford Explorer California license [REDACTED] and the other a white Ford expedition XLT Government Plate [REDACTED]. Regarding the explorer I saw two bullet holes in the top right corner of the front hood area and two marks on the windshield. Regarding the expedition I saw one bullet hole in the top right corner of the hood and one mark on the windshield. Technician [REDACTED] took digital photographs and videotaped these vehicles.

Technician [REDACTED] seized all the above listed items of evidence and she will book them into evidence. See Technician [REDACTED] supplemental report.

I filled out a search warrant inventory forms on the above items we located and seized from outside the residence and inside the residence. I left a copy of these inventory forms and a copy of the search warrant inside the residence.

Humboldt County District Attorney Chief Investigator M. Hislop and Investigator W. Cox arrived on scene during our collection of evidence. Chief Investigator Hislop and

Investigator Cox assisted this office with doing a Total Station (diagram) of the scene and items of evidence located. Investigator Cox will be providing this office with his report when he is finished.

On 06-07-2007 around 1030 hours, I arrived at the Humboldt County Coroner's Office Eureka to attend an autopsy on [REDACTED]. Attending the autopsy was Deputy Coroner C. Van Buskirk, Technician [REDACTED], Detective Lawson, Eureka Police Detective D. Kalis, Autopsy Technician [REDACTED], Intern [REDACTED], and I. Pathologist [REDACTED] was going to conduct the autopsy on [REDACTED]. Detective Kalis and Intern [REDACTED] were present for job experience only.

Prior to the autopsy getting started Technician [REDACTED] took digital photographs of [REDACTED]. Technician [REDACTED] then used a crime light on [REDACTED] body. Technician [REDACTED] did a gun shot residue kit on [REDACTED] hands. [REDACTED] was nude and a piece of small cord was around his left ring finger.

Around 1040 hours, Pathologist [REDACTED] started the autopsy. During the autopsy Pathologist [REDACTED] said [REDACTED] was alive when the fire was started. Upon Pathologist [REDACTED] checking the trachea he found soot. Pathologist [REDACTED] said the cause of death is heat and smoke inhalation pending toxicology. Autopsy was over at 1240 hours.

Prior to the autopsy, Deputy Coroner Van Buskirk took [REDACTED] body and had it x-rayed. In one of the x-rays it showed a small key possibly in the stomach or backside area of [REDACTED] body. This key looked like it would fit a small cabinet or handcuffs. During the autopsy and after the autopsy Pathologist [REDACTED], Deputy Coroner Van Buskirk, and Technician [REDACTED] checked for the key with negative results.

Technician [REDACTED] took digital photographs during the autopsy and would later place them on a CD-R disc and book it into evidence. See Technician [REDACTED] supplemental report for her involvement at the autopsy.

On 06-19-2007 around 1400 hours, I was able to get the original search warrant and affidavit for search warrant. I filled out a return to search warrant. After completing the return for search warrant I took it along with the original search warrant and affidavit for affidavit for search

warrant to Humboldt County Clerk's Office to have them recorded and returned. They were recorded and returned and number issued is 6304.

ITEMS OF EVIDENCE

Exhibit LM-1: CD-R disc - [REDACTED] statement.

Detective Marvin Kirkpatrick

Marvin Kirkpatrick 6-26-07

Supervisor

Date:

Sgt Hanson 7/6/07

HUMBOLDT COUNTY SHERIFF'S OFFICE
PROPERTY/EVIDENCE BOOKING AND RELEASE REPORT

CASE NUMBER: 200703162

PAGE 1 OF 1

DATE STORED 6-4-07	TIME STORED 2200HRS	DATE OF INCIDENT 6-4-07	CRIME ATTEMPTED MURDER - CIRT
NAME OF FINDER (ADDITIONAL VICTIM) TAYLOR, BRIAN - ETC		DOB	ADDRESS
NAME OF FINDER (ADDITIONAL VICTIM)		DOB	ADDRESS
LOCATION PROPERTY WAS FOUND (INCIDENT OCCURRED) MASTER FIELDS, HOOPA			

ADULT ARREST
 JUVENILE ARREST
 SEARCH WARRANT NO.

TYPE OF PROPERTY
 EVIDENCE FOUND SAFEKEEPING

PROPERTY CODES *178

S - Stolen	D - Damaged
R - Recovered	L - Lost
RA - Recovered (For Other Agency)	<u>E</u> - Evidence
F - Found	K - Safekeeping
	C - Contraband

PROPERTY/EVIDENCE LISTING

CODE	ITEM NO.	QTY.	DESCRIPTION	VALUE	NCIC	WEIGHT	DISPOSITION
E	EX. 101-1	1	CD-R DESC - [REDACTED]				- HOLD -

OWNERS OF PROPERTY

ITEMS NO.	NAME	DOB	ADDRESS	PHONE	NOTIFIED
ITEMS NO.	NAME	DOB	ADDRESS	PHONE	NOTIFIED
ITEMS NO.	NAME	DOB	ADDRESS	PHONE	NOTIFIED

LAB WORK REQUIRED

ITEMS NO.	PURPOSE OF EXAM
ITEMS NO.	PURPOSE OF EXAM
ITEMS NO.	PURPOSE OF EXAM

BOOKING OFFICER M. KERR PATRICK	PIN 0583	REPORT DATE 6-4-07	SUPERVISOR REVIEW	PIN	REPORT DATE
------------------------------------	-------------	-----------------------	-------------------	-----	-------------

CASE FILE COPY

hood. [REDACTED] told me the vehicle was at the shop regarding a bullet hole. [REDACTED] told me this bullet appeared to travel down the inside of the fender to the left front side area of the left headlamp. On the left side of the left front headlamp he found six dents where white paint was removed. [REDACTED] told me upon further inspection this bullet went through the driver's door and A post into the upper left front fender wall. On the A post there is black powder residue. [REDACTED] told me he fixed two areas on the A post where paint was chipped off. [REDACTED] told us they took digital photographs of this when they found it and they would e-mail me copies of the photographs.

[REDACTED] showed me the area of where the bullet entered and I saw black powder residue on the A post. I saw on the A post where [REDACTED] repaired the chipped paint. [REDACTED] told me he replaced the left front headlamp and showed me the old one. On the left side of the headlamp, I saw glass chipped. [REDACTED] told me he saved some of the fragments of the bullet and metal he obtained from the vehicle. [REDACTED] handed me these fragments and I later booked them into evidence (Exhibit V-1).

I asked Detective Nord to take digital photographs of the vehicle and I later placed these onto a CD-R disc (Exhibit P-1). I later printed out the photographs and booked the disc into evidence.

I received the e-mailed digital photographs from Rainbow Body Shop. I printed the photographs out. I later placed the digital photographs onto a CD-R disc and booked it into evidence (Exhibit RBS-1).

I contacted Lieutenant Cavinta and let him know what I had found out at Rainbow Body Shop.

Detective Schlesiger is the lead detective in this Hoopa investigation and I contacted him and advised him what I found out at Rainbow Body Shop.

ITEMS OF EVIDENCE

Exhibit P-1: CD-R disc - digital photos taken of vehicle on 07-03-2007.

Exhibit RBS-1: CD-R disc - digital photos taken by Rainbow Body Shop and e-mailed to me when bullet hole was found.

Exhibit V-1: Bullet and metal fragments removed from left fender by [REDACTED] on 06-27-2007 or 06-28-2007.

Detective Marvin Kirkpatrick

Marvin Kirkpatrick 0583.

Supervisor

Date:

STET HANSON 7/11/07

**HUMBOLDT COUNTY SHERIFF'S OFFICE
PROPERTY/EVIDENCE BOOKING AND RELEASE REPORT**

CASE NUMBER: 200703162

PAGE 1 OF 1

DATE STORED <u>7-3-07</u>	TIME STORED <u>1700HRS</u>	DATE OF INCIDENT <u>6-4-07</u>	CRIME <u>ATTEMPTED MURDER - CRT</u>
NAME OF FINDER (ADDITIONAL VICTIM) <u>TAYLOR BRIAN - ETC</u>		DOB	ADDRESS
NAME OF FINDER (ADDITIONAL VICTIM)		DOB	ADDRESS
LOCATION PROPERTY WAS FOUND (INCIDENT OCCURRED) <u>RAINBOW BODY SHOP 110 WABASH AVE, EUREKA</u>			

ADULT ARREST
 JUVENILE ARREST
 SEARCH WARRANT NO. _____

TYPE OF PROPERTY
 EVIDENCE FOUND SAFEKEEPING

PROPERTY CODES *178

S - Stolen	D - Damaged
R - Recovered	L - Lost
RA - Recovered (For Other Agency)	E - Evidence
F - Found	K - Safekeeping
	C - Contraband

PROPERTY/EVIDENCE LISTING

CODE	ITEM NO.	QTY.	DESCRIPTION	VALUE	NCIC	WEIGHT	DISPOSITION
E	Ex p-1	1	CD-R DESC - DIGITAL PHOTOS OF UEH. TAKEN ON 7-3-07				-HOLD-
E	Ex Ras-1	1	CD-R DESC - DIGITAL PHOTOS - PHOTOS TAKEN BY RAINBOW BODY SHOP				-HOLD-
E	Ex U-1	1	BULLET AND METAL FRAGMENTS				-HOLD-

OWNERS OF PROPERTY

ITEMS NO.	NAME	DOB	ADDRESS	PHONE	NOTIFIED

LAB WORK REQUIRED

ITEMS NO.	PURPOSE OF EXAM

BOOKING OFFICER <u>M. KEEN/PTACICIL</u>	PIN <u>0583</u>	REPORT DATE <u>7-3-07</u>	SUPERVISOR REVIEW	PIN	REPORT DATE
--------------------------------------------	--------------------	------------------------------	-------------------	-----	-------------

Schlesiger, Rich

From: Ireland, Kerry
Sent: Wednesday, June 20, 2007 3:50 AM
To: Schlesiger, Rich; Fulton, Todd; Quenell, Bryan; Garcia, Randy; Cavinta, George; Ireland, Kerry
Subject: S.E.T. Trailer Gas, Diversionary, and Less then Lethal Inventory

S.E.T. BOX# 4

Smith & Wesson White Smoke Grenade: 2
Federal Red Smoke Grenade: 1
Smith & Wesson CS Grenade: 1 large
12 Gauge Launching Charges: 2 boxes of 6
Flash Bangs: 9, 4 live and 5 housings
Flash Bang Reloads: 15
37/40 MM Bean Bag Rounds: 24
37/40 MM Rubber Ball Rounds: 12
OC Paint Ball: 1/2 Can







BLACK & GREY RUBBERMAID TOTE

12 Gauge Rubber Buck: 10 boxes of 5 and 6 lose, 56 total
12 Gauge Bean Bag: 4 boxes of 5 and 2 lose, 22 total
12 Gauge OC Barricade Projectiles: 16
12 Gauge CS Barricade Projectiles: 39
12 Gauge Frangible Slug: 23
CS Expulsion Grenade: 6
OC Expulsion Grenade: 7
Stinger CS Grenade: 10
37/38 MM CS Projectile: 4
Arwen Rounds: 25

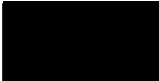

SET Trailer.xls

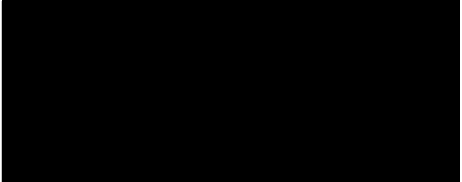
S.E.T. Trailer Inventory

SEATS:	Quantity:	Serial Number:
#1 Misc. Tools in Tool Box	1	
#2 Large Bolt Cutters	1	
#3 Large Hallagan Tool	1	
#4 Thunderbold Battering Ram	1	
#5 Sledge Hammer	1	
#6 Gas Mask Canisters (MSA)	5	
#7 Diversionary Device	14	
#8 High Lighters		
#9 Simunition Ammo	1 case (orange) 5 boxes misc colors	
#10 Simunition Magazine	1	
#11 Diversionary Device Body (Training)	3	
#12 Targets		
#13 Masking Tape	2	
#14 Map of Mckinleyville High School	3	
#15 50 Foot Electrical Cord	2	
#16 Yellow Tool Box with Misc Tools	1	
#17 White Paper Plates		
#18 Pepper Ball Training Rounds	1 Can	
#19 Pepper Ball Oxygen Tank & Regulator	1	
#20 Pole Mirror	1	
#21 Half Roll of Sheriff's Crime Scene Tape	1	
#22 37mm Launcher	1	
#23 Ferret Round (Liquid CS)	3	
#24 Barricade Penetrating Rounds	20	
#25 Ballistic Shield	2	
#26 Dry Erase Board	1	
#27 Pepper Ball Gun	1	
#28 Pepper Ball Gun Air Canister	2	
#29 Pepper Ball Gun Charger	1	
#30 37mm Multi Launcher with 6 rounds	1	
#31 Less Lethal Shotgun	1	
SET BOX #4		
#1 Diversionary Device	8	
#2 Diversionary Device Reloads	10	
#3 Diversionary Device Body	4	
#4 Red Smoke Canister	1	
#5 Ferret Rounds	6 CN 3 CS	
#6 Pepper Ball Gun OC Rounds	1/2 Can	
#7 Riot Agent CS Grenade	2	
#8 OC Expulsion Grenade	3	
#9 12 Gauge Bean Bag Rounds	3 boxes	
#10 12 Gauge Rubber Buck Shot Rounds	3 boxes	
#11 White Smoke Grenade	3	

#12 Smith & Wesson Riot Agent Grenade	1
#13 12 Gauge Launching Cartridges	2 boxes
#14 37mm Stinger Rounds	12



#15 37mm Bean Bag Rounds	24
#16 Fire Ext	1

FRONT OF TRAILER

#1 Black Hawk Breachers Bag w/ Tools	1
#2 Spool of Thrown Phone Wire	1
#3 Stinger Flashlights	9
#4 Motorola Radio Battery	3
#5 Box of Paper Pistol Targets	1
#6 Large Pole Mirror	1
#7 Rescue Phone	1
#8 55 Grain .223 Rounds	1 case
#9 Smith and Wesson .40 Pistol Rounds	9 boxes
#10 Stinger Flashlight	10

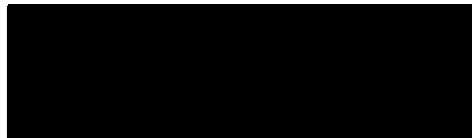

BLACK AND GREY RUBBERMAID TOTE

#1 12 Gauge Ferret Rounds	2 bags
#2 CS Expulsion Grenade	9
#3 OC Expulsion Grenade	4
#4 CS Stinger Grenade	9

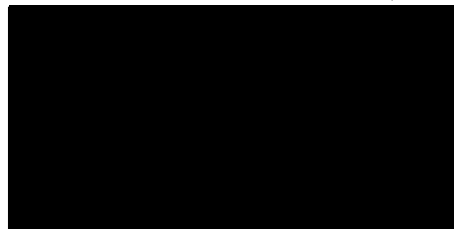

#5 Frangible 12 Gauge Slugs	23
#6 Rubber Buckshot 12 Gauge Rounds	8
#7 Flexible Baton Rounds	1 box
#8 Rubber Pellet Rounds 12 Gauge	6
#9 Arwen Rounds	25
#10 Shotgun Launcher	2
#11 Cleaning Rods and Patches	

SET BOX #3

#1 Nylon Gun Brush	1
#2 Ranger .40 Pistol Rounds	13 boxes
#3 20 Round M-4 Magazine (loaded)	11
#4 American Eagle .223 Rifle Rounds	7 cases
#5 American Eagle .22 Rifle Rounds	2 boxes
#6 Blue Cleaning Towel	1
#7 Winchester 00 Buck Rounds	6 boxes
#8 Winchester Rifled Slugs	6 boxes
#9 Gun Lube	1 tube
#10 12 Gauge Bore Brush	1
#11 .223 Bore Brush	1
#12 .40 Bore Brush	1

H-50



FERRET® - 40

LIQUID/POWDER - OC, CN, CS & PRACTICE

BACKGROUND: The 40MM Ferret® comes from the design of Defense Technology's 40-14 and T40-14 Barricade Penetrating Rounds and the original 40MM Ferrets from Federal Laboratories. The FERRET®-40 is designed to deliver chemical agents in barricade situations from a 40MM launcher.

Code Recognition:	Liquid				Powder			
	OC	CN	CS	P	OC	CN	CS	P
CURRENT PART ID:	1260	1261	1262	1263	1290	1291	1292	1293
DEFENSE TECHNOLOGY:	40-14OC	40-14CN	40-14CS	40-14P	40-T14OC	40-T14CN	40-T14CS	40-T14P
FEDERAL LABORATORIES:	SGA420	SGA410	SGA400	P-400	N/A	N/A	N/A	N/A

PRODUCT SPECIFICATIONS (Subject to change without notice. All specifications are averages.)

Diameter:	1.6 inches [40MM]		
Length:	4.8 inches [12.2 cm]		
Maximum Range:	200 yards [182.9 meters]		
Max. Effective Range:	50 yards [45.7 meters]		
Velocity:	650 fps [198 mps]		
Active Agent:	Liquid	Powder	
	CN:	0.53 oz. [15.0 g]	0.21 oz. [6.0 g]
	CS:	0.28 oz. [8.0 g]	0.21 oz. [6.0 g]
	OC:	0.16 oz. [4.5 g]	0.02 oz. [0.59 g]
Discharge Time:	Instantaneous on impact		
Warranty:	Operation: 5 Years from Date of Manufacture Training: 6 years from Date of Manufacture		

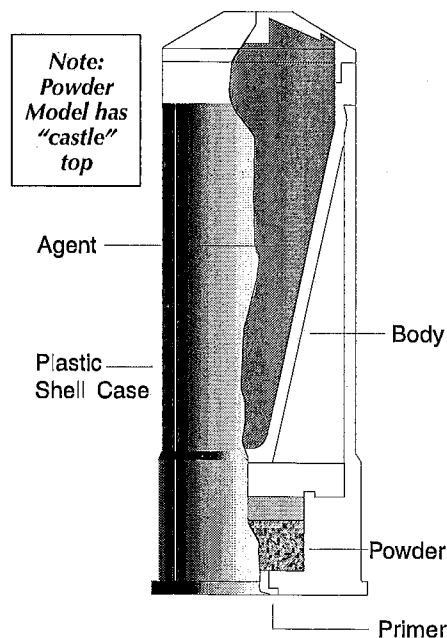

OPERATION: The Ferret®-40 is a frangible projectile filled with chemical agent. Spin stabilization from fins and barrel rifling affords maximum standoff distance and accuracy for safety. The Ferret®-40 is non-burning and suitable for indoor use. Used primarily by tactical teams, it is designed to penetrate barriers, such as windows, particleboard doors, and interior walls. Upon impacting the barrier, the nose cone ruptures and instantaneously delivers the agent payload inside of a structure.

APPLICATION: In a tactical deployment situation, the Ferret®-40 is primarily used to dislodge barricaded subjects from confined areas. Its purpose is to minimize the risks to all parties through pain compliance, temporary discomfort and/or incapacitation of potentially violent or dangerous subjects.

The Ferret®-40 is available with either a liquid or powder carrier. Liquid carriers provide additional weight over powder carriers improving penetration potential. Once delivered, powder carriers tend to keep the agent airborne longer and may have more effect. Liquid carriers contain red dye to aid in shot placement.

Shot placement and trajectory considerations should be based on hardness of the barrier. However, accuracy is dependent on the operator and the condition of the launcher. The Ferret®-40 possesses greater penetration capabilities than the 37MM Ferret®. **DIRECT FIRING THE FERRET AT ANY INDIVIDUAL CAN CAUSE DEATH OR SERIOUS BODILY INJURY.**

WARNING: This product is to be used only by authorized and trained Law Enforcement, Correction, or Military Personnel. This product may cause serious injury or death to you or others. This product may cause serious damage to property. Handle, store and use with extreme care and caution. Use only as instructed.

40		
INDOORS	NON-BURNING	LIQUID
INDOORS	NON-BURNING	POWDER





FERRET[®] - 12

LIQUID/POWDER - OC, CN, CS & PRACTICE

BACKGROUND: The 12-gauge Ferret[®] comes from the design of Defense Technology's #23 Barricade Penetrating Rounds and the original 12-gauge Ferrets from Federal Laboratories. The FERRET[®] - 12 is designed to deliver chemical agents in barricade situations from a 12-gauge shotgun.

Code Recognition:	Liquid				Powder			
	OC	CN	CS	P	OC	CN	CS	P
CURRENT PART ID:	3010	3011	3012	3013	3090	3091	3092	3093
DEFENSE TECHNOLOGY:	23OC	23CN	23CS	23P	T23OC	T23CN	T23CS	T23P
FEDERAL LABORATORIES	SGA120	SGA110	SGA100	P-100	N/A	N/A	N/A	N/A

PRODUCT SPECIFICATIONS (Subject to change without notice. All specifications are averages.)

Caliber:	12-Gauge	
Length:	2.50 inches [6.35 cm]	
Maximum Range:	100 yards [91.4 meters]	
Max. Effective Range:	50 yards [45.7 meters]	
Velocity:	1000 fps [305 mps]	
Active Agent:	Liquid Powder	
	CN:	0.05 oz. [1.42 g] 0.03 oz. [0.86 g]
	CS:	0.025 oz. [0.71 g] 0.03 oz. [0.86 g]
	OC:	0.015 oz. [0.43 g] 0.002 oz. [0.06 g]
Discharge Time:	Instantaneous on impact	
Warranty:	Operation: 5 Years from Date of Manufacture Training: 6 years from Date of Manufacture	

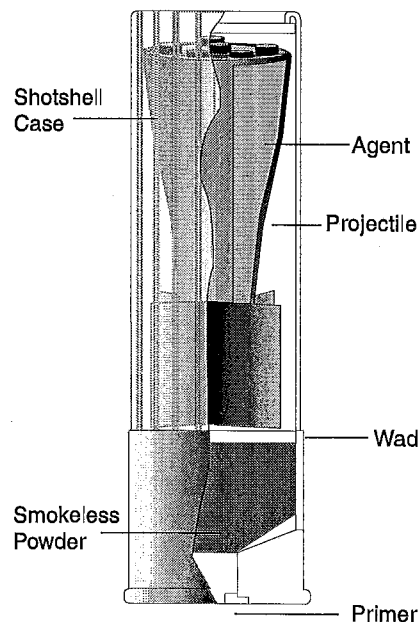

OPERATION: The Ferret[®]-12 is a fin-stabilized frangible projectile filled with chemical agent. It affords standoff distance for safety. The Ferret[®]-12 is non-burning and suitable for indoor use. Used primarily by tactical teams, it is designed to penetrate barriers, such as windows and hollow core doors. Upon impacting the barrier, the nose cone ruptures and instantaneously delivers a small chemical payload inside of a structure or vehicle.

APPLICATION: In a tactical deployment situation, the Ferret[®]-12 is primarily used to dislodge barricaded subjects from very small confined areas. Its purpose is to minimize the risks to all parties through pain compliance, temporary discomfort and/or incapacitation of potentially violent or dangerous subjects.

The Ferret[®]-12 is available with either liquid or powder carriers for the agent. Liquid carriers provide additional weight over the powder carrier improving barricade penetration potential. Once delivered, powder carriers tend to keep the agent airborne longer than liquid carriers and may have more effect. Liquid carriers contain red dye to aid in shot placement.

Shot placement and trajectory considerations should be based on hardness of the barrier. However, accuracy is dependent on the operator and the condition of barrel (cylinder choke is recommended). Double-paned windows and heavy drapes will reduce or negate delivery of the chemical agent payload. **DIRECT FIRING THE FERRET AT ANY INDIVIDUAL CAN CAUSE DEATH OR SERIOUS BODILY INJURY.**

WARNING: This product is to be used only by authorized and trained Law Enforcement, Correction, or Military Personnel. This product may cause serious injury or death to you or others. This product may cause serious damage to property. Handle, store and use with extreme care and caution. Use only as instructed.

12

 INDOORS	 NON-BURNING	 LIQUID
 INDOORS	 NON-BURNING	 POWDER



H50



FLAMELESS EXPULSION GRENADE

OC, CN, CS AND PRACTICE

PATENT # 5,069,134

BACKGROUND: The Flameless Expulsion Grenade comes from the patented design of Defense Technology's T-16 grenades. Designed for indoor use, this grenade's contents are expelled upon actuation of a CO₂ cartridge that will affect a confined area consisting of approximately 1500 square feet.

Code Recognition:	OC	CN	CS	P
CURRENT PART ID:	2040	2041	2042	2043
DEFENSE TECHNOLOGY:	T16-OC	T16-CN	T16-CS	T16-P
FEDERAL LABORATORIES:	N/A	N/A	N/A	N/A

PRODUCT SPECIFICATIONS

(Subject to change without notice. All specifications are averages.)

Diameter:	1.65 inches (4.2 cm)		
Length:	7.5 inches (19 cm)		
Fuze:	M201A1 Type		
Active Agent:	CN/CS	0.16 oz. (4.5 grams)	
	OC	0.02 oz. (0.5 grams)	
Discharge Time:	3 seconds		
Launchable:	No		
Warranty:	Operations:	5 years from Date of Manufacture	
	Training:	6 years from Date of Manufacture	

OPERATION: The Flameless Expulsion Grenade has a 1.5-second delay, followed by a submunition that mechanically activates a CO₂ cartridge. The released CO₂ pressure expels the powder through one or two (or both) ports on the side of the canister within seconds. The Flameless Expulsion Grenade is extremely safe for indoor use. The extremely light powder from the agent will remain airborne for extended periods depending on the draft conditions. The Expulsion Grenade cannot be launched.

APPLICATION: The Flameless Expulsion Grenade is most commonly used in tactical deployment situations by Law Enforcement and Corrections. Its applications include detection and/or dislodging barricaded subjects, or for cell extractions.

The purpose of the Flameless Expulsion Grenade is to minimize the risks to all parties through pain compliance, temporary discomfort and/or incapacitation of potentially violent or dangerous subjects.

The minimal agent content and the powder carrier will not usually provide ample coverage to be effective outdoors, unless walls or barriers confine it. It is not a suitable choice for outdoor crowd management.

As a result of the Flameless Expulsion Grenades design, it may have erratic movement when deployed on hard surfaces such as concrete. This is desirable as the movement further restricts throwback potential. All grenades are overfilled which may result in excessive agent remaining in the grenade after deployment. The Flameless Expulsion Grenade will fit any tactical vest designed to carry 37MM munitions.

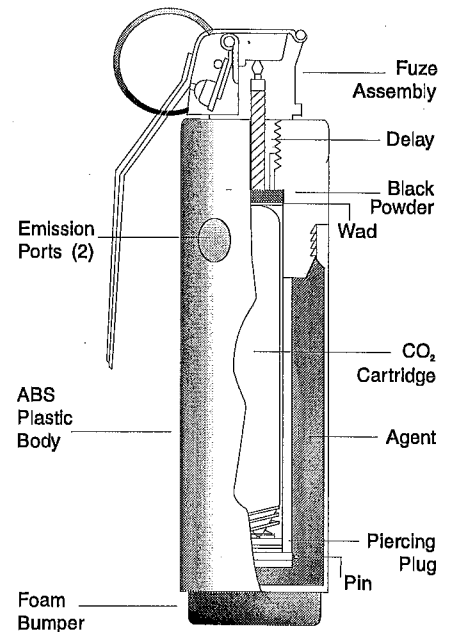

WARNING: This product is to be used only by authorized and trained Law Enforcement, Correction, or Military Personnel. This product may cause serious injury or death to you or others. This product may cause serious damage to property. Handle, store and use with extreme care and caution. Use only as instructed.

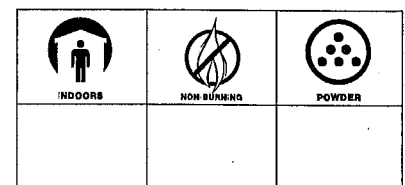

CDC



TRI-CHAMBER FLAMELESS GRENADE

CN, CS AND SMOKE

BACKGROUND: The Tri-Chamber Flameless Grenade comes from the design of Federal Laboratories 117CN/517CS Grenades. Designed for indoor use, this grenade's pyrotechnic contents are burned within an internal can that is one of three in this design. The internal combustion allows the chemical-laden smoke to release through three (3) ports on the outer canister side while safely containing any of the fire-producing properties within the two internal canisters. The fuze is shrouded to further protect surrounding materials from the possibility of fire.

Code Recognition:	CN	CS	SMOKE
CURRENT PART ID:	1031	1032	1033
DEFENSE TECHNOLOGY:	N/A	N/A	N/A
FEDERAL LABORATORIES:	117CN	517CS	317S

PRODUCT SPECIFICATIONS

(Subject to change without notice. All specifications are averages.)

Diameter:	2.62 inches [6.7 cm]		
Length:	6.62 inches [16.8 cm]		
Fuze:	M201A1 Type		
Active Agent:	CN / CS	0.70 oz. [20 grams]	
Discharge Time:	CN / CS	30 - 40 seconds	
	Smoke	30 - 40 seconds	
Launchable:	No		
Warranty:	Operation:	5 Years From Date of Manufacture	
	Training:	6 Years From Date of Manufacture	

APPLICATION: The Tri-Chamber Flameless Grenade is most commonly used in both crowd control and tactical deployment situations by Law Enforcement and Corrections, but was designed with the barricade situation in mind. Its applications in tactical situations are primarily to detect and/or dislodge barricaded subjects. It has also been used during high-risk warrant service operations.

The purpose of the Tri-Chamber Flameless Grenade is to minimize the risks to all parties through pain compliance, temporary discomfort, and/or incapacitation of potentially violent or dangerous subjects.

The Tri-Chamber Flameless Grenade provides the option of delivering a pyrotechnic chemical device indoors maximizing the chemicals' effectiveness via heat and vaporization, while minimizing or negating the chance of fire to the structure. The actual smoke and chemical content is minimal enough that oxygen displacement concerns and LCT is rarely reached. It is a viable option when chemical-laden powders or liquids are ineffective or inappropriate for the situation. As with all pyrotechnic carriers, contamination will be greater than that experienced with powders or liquids.

The minimal agent content may make this device less suited for outdoor operations unless it is the operator's desire to deliver a small amount of agent prior to the use of larger canisters and payloads.

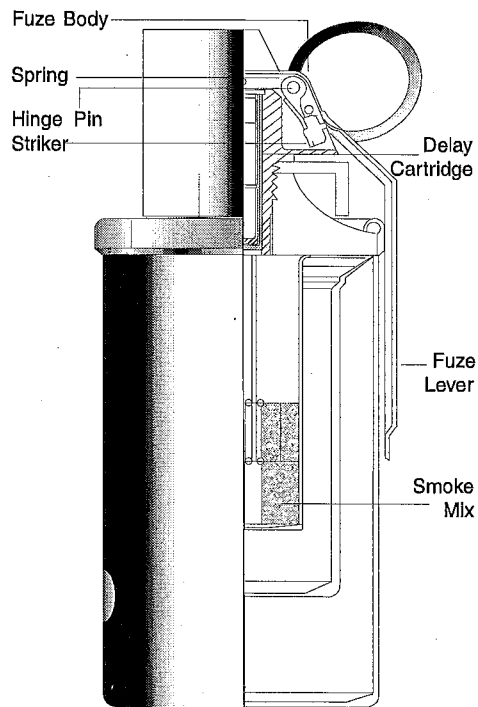

WARNING: This product is to be used only by authorized and trained Law Enforcement, Correction, or Military Personnel. This product may cause serious injury or death to you or others. This product may cause serious damage to property. Handle, store and use with extreme care and caution. Use only as instructed.

INDOORS/OUTDOORS	NON BURNING	PYROTECHNIC



CDC



STINGER® GRENADE

RUBBER PELLET RP, RP/CS & RP/OC

BACKGROUND: The Stinger Grenade comes from the design of the Defense Technology #15 Stinger Grenade series. The Stinger Grenade is a combination Specialty Impact Munition and Diversion Device that may incorporate optional CS or OC-laden powder, if desired. The Stinger Grenade is a maximum effect device as it delivers up to four stimuli for psychological and physiological effect: rubber pellets, light, sound, and optional chemical agent or OC.

Code Recognition:	RP ONLY	RP/CS	RP/OC
CURRENT PART ID:	1090	1088	1089
DEFENSE TECHNOLOGY:	15RP	15RP/CS	15RP/OC
FEDERAL LABORATORIES:	N/A	N/A	N/A

PRODUCT SPECIFICATIONS

SUBMUNITION SPECIFICATIONS

Construction:	Rubber Ball Grenade Body	Active Agent:	CS - 0.07 oz. [2.0 grams] when applicable OC - 0.01 oz. [0.30 grams] when applicable	
Explosive Compound:	8.0 grams Flash Powder			
Diameter:	3.1 inches 7.9 cm	Caliber:	32	
Length:	5.2 inches 13.2 cm	Diameter:	0.32 in.	0.81 cm
Projectiles:	180 Rubber Balls [approx.]	Pellet:	75 Durometer "A" Scale	
Launchable:	Yes			
Warranty:	5 years			

(Subject to change without notice. All specifications are averages.)

OPERATION: The Stinger Grenade has an initial 1.5-second delay that initiates fuze assembly separation, followed by another 0.5-second delay before the function of the device. The blast is sufficient to project the rubber balls and optional chemical agent in a 50-foot radius.

APPLICATION: The Stinger Grenade is most widely used as a crowd management tool by Law Enforcement and Corrections in indoor and outdoor operations. However, as with any pyrotechnic device fire-fighting equipment should be available. It has also proven successful in tactical operations.

As a pain compliance, distraction and disorientation device for crowd management, it may be hand thrown or launched in the general direction of the crowd. It may be deployed for ground bursts or aerial bursts at the discretion of the operator. It is generally reserved as a last selection when chemical agents and specialty impact munitions have not resolved the disorder or routed the crowd. It has been used quite successfully for several years in correctional and jail facilities against non-compliant or riotous inmates.

Its applications in tactical deployment situations include high-risk warrant service, hostage rescue, and the arrest of potentially violent subjects. The purpose of the Stinger Grenade is to minimize the risks to all parties through pain compliance, temporary distraction or disorientation of potentially violent or dangerous subjects.

IMPROPER USE OF THE STINGER GRENADE CAN RESULT IN DEATH OR SERIOUS BODILY INJURY.

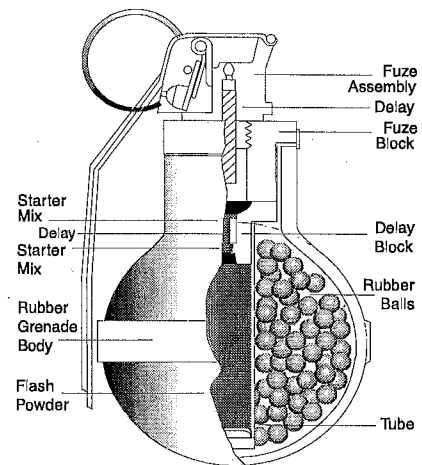

WARNING: This product is to be used only by authorized and trained Law Enforcement, Correction, or Military Personnel. This product may cause serious injury or death to you or others. This product may cause serious damage to property. Handle, store and use with extreme care and caution. Use only as instructed.

INDOORS/OUTDOORS	EXPLOSIVE	

HUMBOLDT CO SHERIFF
INCLUSIVE CASE REPORT

Date: 6/5/2007

Page: 1

Case Number
200402508

Incident Case Number 200402508 IR Title A/A CHP, VC 23152(A)(B)/H&S 11357(B)
Date/Time Occurred 4/17/2004 5:05:34 PM IR Date/Time 4/17/2004 6:19:20 PM
Name/Business Name INTERSECTION Incident Location U:S/R 96 S/R 299, WILLOW CREEK, CA
Case Clearance CLEARED ARREST ADULT Case Clearance Date 4/17/2004

Offense

Offense Code CRIMINAL CSA COMMITTED Location STREET OR SIDEWALK
Description AGENCY ASSIST

Offense Code VC24603(E) CSA COMMITTED Location STREET OR SIDEWALK
Description INOPERATIVE BRAKE LIGHT

Offense Code HS11357(B) CSA COMMITTED Location STREET OR SIDEWALK
Description POSSESS MARIJUANA

Offense Code PC1203.3 CSA COMMITTED Location STREET OR SIDEWALK
Description VIOLATION OF PROBATION

Person

Person Type [REDACTED]
Name Type LEGAL Last [REDACTED] First [REDACTED] Middle [REDACTED]
Name Type LEGAL Last [REDACTED] First [REDACTED] Middle [REDACTED]
Address Type OTHER Address [REDACTED] Apartment [REDACTED]
City HOOPA State CALIFORNIA Zip 95546 Phone [REDACTED]
Address Type OTHER Address [REDACTED] Apartment [REDACTED]
City HOOPA State CALIFORNIA Zip 95546 Phone [REDACTED]
DOB [REDACTED] Age 23 Sex MALE Race INDIAN Height 511 Weight 160
Hair Color BROWN Eye Color BROWN Driver License [REDACTED] State CALIFORNIA

Property

Item No 1 Code EVIDENCE/SEI Article MARIJUANA Make [REDACTED] Model [REDACTED]
Description BLUE GLASS PIPE CONTAINING Serial No [REDACTED] QTY 0 Value [REDACTED]

Vehicle

Veh No 1 Type AUTOMOBILE Top Color [REDACTED] Bottom Color [REDACTED] Year [REDACTED]
Make CHRYSLER Model LEBARON License [REDACTED] State CALIFORNIA Expires 2004
VIN [REDACTED] Vehicle Description [REDACTED]

Narrative/Summary

Narrative - IR 04/17/2004 200402508

On 04/17/04 at about 1705 hours, while on routine patrol, in full uniform and driving a marked patrol car, in the Willow Creek area of S/R 299, I saw a brown Chrysler Le Baron stopped at the intersection of Country Club Rd at S/R 299 with a broken driver's side stop light lens, (A violation of VC 24603(e)). Three males occupied the vehicle, the driver, later identified as [REDACTED] was wearing a red shirt, and the rear passenger was wearing a white shirt.

HUMBOLDT CO SHERIFF
INCLUSIVE CASE REPORT

Date: 6/5/2007

Page: 2

Case Number
200402508

I attempted to maneuver through the traffic to initiate a traffic stop, but I was not able to. I resumed routine patrol and located the vehicle parked, unoccupied, on the south side of S/R 299, near the intersection of S/R 96. I watched the vehicle and saw [REDACTED] sit in the driver's seat, start the vehicle and drive Eastbound on S/R 299 alone. Again traffic prevented me from initiating a traffic stop before [REDACTED] exited the vehicle at the Willow Creek Chevron. Again I watched the vehicle leave the Willow Creek Chevron, westbound on S/R 299, and pull into the parking lot of Bob's Shopping Center, where he parked and exited his vehicle prior to my arrival. As I entered the parking lot, a passing motorist, who was visibly shaken, flagged me down. The motorist stated the driver of the Le Baron, ([REDACTED] had nearly struck her vehicle as he entered the parking lot at a high rate of speed.

I advised Deputy B. Taylor of the incident and requested he assist me with the traffic stop once [REDACTED] occupied his vehicle.

I saw [REDACTED] back out of his parking space and approach S/R 299 from the east entrance. [REDACTED] hesitated at the intersection for about five seconds and then turned westbound onto S/R 299. I pulled in behind [REDACTED] at an approximate speed of 65 MPH in a 55 MPH zone.

I activated my forward facing solid red emergency light to initiate a traffic stop on [REDACTED] vehicle. [REDACTED] applied his breaks abruptly, crossed the #1 and #2 eastbound lanes and came to a stop onto the dirt shoulder.

When I approached the vehicle, [REDACTED] asked, "Why did you stop me?" I advised [REDACTED] his driver's side break lamp lens was broken and showing white light to the rear. [REDACTED] stated, "I was going 55!" I asked [REDACTED] for his driver's license, registration and insurance documents. While looking for his driver's license, [REDACTED] passed it three times as he searched through his wallet. [REDACTED] eventually provided all of the documents I had asked for.

While I spoke with [REDACTED] I could smell the odor of an alcoholic beverage coming from his vehicle. I asked [REDACTED] "How much have you had to drink tonight?" [REDACTED] answered, "I haven't drank nothing!" I looked at [REDACTED] eyes and saw they were red and watery, and I noticed his speech was slow and slurred.

I radioed Sheriff's Dispatch and requested a warrant's check on [REDACTED] Sheriff's Dispatch told me that [REDACTED] was on Summary Probation for resisting arrest with terms of "Obey all laws and totally abstain from alcohol with a search and seizure clause. I requested an officer from the California Highway Patrol respond to my location to evaluate [REDACTED] level of intoxication.

I advised [REDACTED] of his terms of probation and that I was going to conduct a probation search of his person and the vehicle under his control. After I searched [REDACTED] person, I advised him he was being detained while I searched his vehicle. I placed [REDACTED] in the rear seat of my patrol car for officer safety as I searched his vehicle. As [REDACTED] walked to my patrol car, I noticed

HUMBOLDT CO SHERIFF
INCLUSIVE CASE REPORT

Date: 6/5/2007

Page: 3

Case Number
200402508

he walked with an unsteady gait and swayed side to side.

During the search of [REDACTED] vehicle, I located a blue colored glass pipe on the front passenger seat. [REDACTED] stated, "That's my buddy's, he has a 215 card." I seized the pipe as evidence. No other items of contraband were located in [REDACTED] control.

CHP officer M. Noland arrived and investigated [REDACTED] level of intoxication. As a result of Officer Noland's investigation, [REDACTED] was placed under arrest for driving under the influence of drugs and/or alcohol.

Officer Noland completed a CHP form 180 for the storage of the vehicle and asked me to secure it until the tow company arrived. Buddy's auto arrived and I released the vehicle to them.

Any further action will be made a matter of a written report.

Nothing further.

Officer - IR 1334 HICKS CORY Report Date 4/17/2004

Supervisor Review 1025 MILLER KEVIN A Review Date 4/19/2004

Distribution CALIFORNIA HIGHWAY PATROL, TRINITY RIVER AREA, WILLOW CREEK RESIDENT
POST-OFFICER M. NOLAND; HUMBOLDT COUNTY DISTRICT ATTORNEY'S OFFICE

HUMBOLDT CO SHERIFF
INCLUSIVE CASE REPORT

Date: 6/5/2007

Page: 1

Case Number
200402508

Incident Case Number 200402508 IR Title A/A CHP, VC 23152(A)(B)/H&S 11357(B)
Date/Time Occurred 4/17/2004 5:05:34 PM IR Date/Time 4/17/2004 6:19:20 PM
Name/Business Name INTERSECTION Incident Location U:S/R 96 S/R 299, WILLOW CREEK, CA
Case Clearance CLEARED ARREST ADULT Case Clearance Date 4/17/2004

Offense

Offense Code CRIMINAL CSA COMMITTED Location STREET OR SIDEWALK
Description AGENCY ASSIST

Offense Code VC24603(E) CSA COMMITTED Location STREET OR SIDEWALK
Description INOPERATIVE BRAKE LIGHT

Offense Code HS11357(B) CSA COMMITTED Location STREET OR SIDEWALK
Description POSSESS MARIJUANA

Offense Code PC1203.3 CSA COMMITTED Location STREET OR SIDEWALK
Description VIOLATION OF PROBATION

Person

Person Type [REDACTED]
Name Type LEGAL Last [REDACTED] First [REDACTED] Middle [REDACTED]
Name Type LEGAL Last [REDACTED] First [REDACTED] Middle [REDACTED]
Address Type OTHER Address [REDACTED] Apartment [REDACTED]
City HOOPA State CALIFORNIA Zip 95546 Phone [REDACTED]
Address Type OTHER Address [REDACTED] Apartment [REDACTED]
City HOOPA State CALIFORNIA Zip 95546 Phone [REDACTED]
DOB [REDACTED] Age 23 Sex MALE Race INDIAN Height 511 Weight 160
Hair Color BROWN Eye Color BROWN Driver License [REDACTED] State CALIFORNIA

Property

Item No 1 Code EVIDENCE/SEI Article MARIJUANA Make [REDACTED] Model [REDACTED]
Description BLUE GLASS PIPE CONTAINING Serial No [REDACTED] QTY 0 Value [REDACTED]

Vehicle

Veh No 1 Type AUTOMOBILE Top Color [REDACTED] Bottom Color [REDACTED] Year [REDACTED]
Make CHRYSLER Model LEBARON License [REDACTED] State CALIFORNIA Expires 2004
VIN [REDACTED] Vehicle Description [REDACTED]

Narrative/Summary

Narrative - IR 04/17/2004 200402508

On 04/17/04 at about 1705 hours, while on routine patrol, in full uniform and driving a marked patrol car, in the Willow Creek area of S/R 299, I saw a brown Chrysler Le Baron stopped at the intersection of Country Club Rd at S/R 299 with a broken driver's side stop light lens, (A violation of VC 24603(e)). Three males occupied the vehicle, the driver, later identified as [REDACTED] [REDACTED] was wearing a red shirt, and the rear passenger was wearing a white shirt.

HUMBOLDT CO SHERIFF
INCLUSIVE CASE REPORT

Date: 6/5/2007

Page: 2

Case Number
200402508

I attempted to maneuver through the traffic to initiate a traffic stop, but I was not able to. I resumed routine patrol and located the vehicle parked, unoccupied, on the south side of S/R 299, near the intersection of S/R 96. I watched the vehicle and saw [REDACTED] sit in the driver's seat, start the vehicle and drive Eastbound on S/R 299 alone. Again traffic prevented me from initiating a traffic stop before [REDACTED] exited the vehicle at the Willow Creek Chevron. Again I watched the vehicle leave the Willow Creek Chevron, westbound on S/R 299, and pull into the parking lot of Bob's Shopping Center, where he parked and exited his vehicle prior to my arrival. As I entered the parking lot, a passing motorist, who was visibly shaken, flagged me down. The motorist stated the driver of the Le Baron, ([REDACTED] had nearly struck her vehicle as he entered the parking lot at a high rate of speed.

I advised Deputy B. Taylor of the incident and requested he assist me with the traffic stop once [REDACTED] occupied his vehicle.

I saw [REDACTED] back out of his parking space and approach S/R 299 from the east entrance. [REDACTED] hesitated at the intersection for about five seconds and then turned westbound onto S/R 299. I pulled in behind [REDACTED] at an approximate speed of 65 MPH in a 55 MPH zone.

I activated my forward facing solid red emergency light to initiate a traffic stop on [REDACTED] vehicle. [REDACTED] applied his breaks abruptly, crossed the #1 and #2 eastbound lanes and came to a stop onto the dirt shoulder.

When I approached the vehicle, [REDACTED] asked, "Why did you stop me?" I advised [REDACTED] his driver's side break lamp lens was broken and showing white light to the rear. [REDACTED] stated, "I was going 55!" I asked [REDACTED] for his driver's license, registration and insurance documents. While looking for his driver's license, [REDACTED] passed it three times as he searched through his wallet. [REDACTED] eventually provided all of the documents I had asked for.

While I spoke with [REDACTED] I could smell the odor of an alcoholic beverage coming from his vehicle. I asked [REDACTED] "How much have you had to drink tonight?" [REDACTED] answered, "I haven't drank nothing!" I looked at [REDACTED] eyes and saw they were red and watery, and I noticed his speech was slow and slurred.

I radioed Sheriff's Dispatch and requested a warrant's check on [REDACTED] Sheriff's Dispatch told me that [REDACTED] was on Summary Probation for resisting arrest with terms of "Obey all laws and totally abstain from alcohol with a search and seizure clause. I requested an officer from the California Highway Patrol respond to my location to evaluate [REDACTED] level of intoxication.

I advised [REDACTED] of his terms of probation and that I was going to conduct a probation search of his person and the vehicle under his control. After I searched [REDACTED] person, I advised him he was being detained while I searched his vehicle. I placed [REDACTED] in the rear seat of my patrol car for officer safety as I searched his vehicle. As [REDACTED] walked to my patrol car, I noticed

HUMBOLDT CO SHERIFF
INCLUSIVE CASE REPORT

Date: 6/5/2007

Page: 3

Case Number
200402508

he walked with an unsteady gait and swayed side to side.

During the search of [REDACTED] vehicle, I located a blue colored glass pipe on the front passenger seat. [REDACTED] stated, "That's my buddy's, he has a 215 card." I seized the pipe as evidence. No other items of contraband were located in [REDACTED] control.

CHP officer M. Noland arrived and investigated [REDACTED] level of intoxication. As a result of Officer Noland's investigation, [REDACTED] was placed under arrest for driving under the influence of drugs and/or alcohol.

Officer Noland completed a CHP form 180 for the storage of the vehicle and asked me to secure it until the tow company arrived. Buddy's auto arrived and I released the vehicle to them.

Any further action will be made a matter of a written report.

Nothing further.

Officer - IR 1334 HICKS CORY Report Date 4/17/2004

Supervisor Review 1025 MILLER KEVIN A Review Date 4/19/2004

Distribution CALIFORNIA HIGHWAY PATROL, TRINITY RIVER AREA, WILLOW CREEK RESIDENT
POST-OFFICER M. NOLAND; HUMBOLDT COUNTY DISTRICT ATTORNEY'S OFFICE

HUMBOLDT CO SHERIFF
INCLUSIVE CASE REPORT

Date: 6/5/2007

Page: 1

Case Number
200505582

Incident Case Number 200505582 IR Title UNLICENSED DRIVER
Date/Time Occurred 9/13/2005 10:10:56 PM IR Date/Time 9/13/2005 10:29:56 PM
Name/Business Name _____ Incident Location U: CAL PAC RD/96, HOOPA, CA
Case Clearance CLEARED ARREST ADULT Case Clearance Date 9/14/2005

Offense

Offense Code VC12500(A) CSA COMMITTED Location STREET OR SIDEWALK
Description DRIVE WHEN UNLICENSED

Offense Code VC16028(A) CSA COMMITTED Location _____
Description NO PROOF OF INSURANCE

Offense Code VC4000(A) CSA COMMITTED Location _____
Description REGISTRATION REQUIRED

Person

Person Type _____
Name Type LEGAL Last _____ First _____ Middle _____
Name Type LEGAL Last _____ First _____ Middle _____
Address Type OTHER Address _____ Apartment _____
City HOOPA State CALIFORNIA Zip 95546 Phone _____
DOB _____ Age 24 Sex MALE Race INDIAN Height 511 Weight 160
Hair Color BROWN Eye Color BROWN Driver License _____ State CALIFORNIA

Vehicle

Veh No 1 Type AUTOMOBILE Top Color _____ Bottom Color _____ Year _____
Make FORD Model AEROSTAR License _____ State CALIFORNIA Expires _____
VIN _____ Vehicle Description _____

Narrative/Summary

Narrative - IR On 091305 at approximately 2210 hours, I was traveling northbound State Scenic Route 96 and just entering the Hoopa Indian Reservation from the south. As I rounded a curve in the road near Campbell Creek, I observed a green Ford van enter the roadway from a driveway and turn northbound in front of me. I depressed my brakes to slow down and pull up behind the van. The van was traveling at a slow rate of speed as I followed. I observed that the California Plate (_____) was displaying an expired registration tab. The van turned off State Scenic Route 96 onto Cal Pac Road.

I initiated a traffic stop on the vehicle by illuminating the overhead emergency lights located on top of my marked Sheriff's patrol vehicle (Ford 4x4). The van pulled over to the right and stopped. I made personal contact with a male driver and requested his driver's license. The driver stated that his driver's license had been taken away and he didn't have a valid license to drive. I asked him to produce any form of identification and he gave me a California driver's license while stating, "I just use this for ID." The card displayed the name, _____ of Hoopa, CDL# _____ I confirmed the driver's ID, using the photograph on the card.

**HUMBOLDT CO SHERIFF
INCLUSIVE CASE REPORT**

Date: 6/5/2007

Page: 2

Case Number
200505582

I requested a DL check from the Humboldt County Sheriff's Communications Center. I was told that the subject's DL was suspended but required notification. I prepared a CHP 310 and notified the subject of the suspension. I asked the driver for a registration card and proof of insurance, he had neither.

I issued the driver a citation (#93519) for violation of Vehicle Code Sections 12500(a); operating a motor vehicle while unlicensed, 16028(a); no proof of insurance and 4000(a); expired registration. The driver was released on his promise to appear and was given a copy of the citation.

The driver's parent and the registered owner of the vehicle arrived on scene. I released custody of the van to the registered owner, identified as [REDACTED] of Hoopa.

I confiscated the California Driver's License and later placed it into a California DMV Driver's Safety preaddressed envelope along with the CHP 310.

Attachments: Citation #93519 and CLETS printouts.

No further action required.

End report.

Officer - IR 0327 FILYAU FREDERICK R

Report Date 9/13/2005

Supervisor Review 1025 MILLER KEVIN A

Review Date 9/15/2005

Distribution DA

HUMBOLDT CO SHERIFF
INCLUSIVE CASE REPORT

Date: 6/5/2007

Page: 1

Case Number
200207670

Incident Case Number 200207670 IR Title AGENCY ASSIST HOOPA AMBULANCE
Date/Time Occurred 12/7/2002 3:15:50 PM IR Date/Time 12/7/2002 4:53:43 PM
Name/Business Name _____ Incident Location U:MATSEN FLAT, HOOPA, CA
Case Clearance CLOSED Case Clearance Date 12/7/2002

Offense

Offense Code NONCRIM CSA COMMITTED Location BANK
Description _____

Person

Person Type INVOLVED PERSON
Name Type _____ Last ██████████ First ██████████ Middle ██████████
Address Type OTHER Address ██████████ Apartment _____
City HOOPA State CALIFORNIA Zip 95546 Phone _____
DOB ██████████ Age 21 Sex MALE Race INDIAN Height 510 Weight 180
Hair Color BROWN Eye Color BROWN Driver License _____ State _____

Narrative/Summary

Narrative - IR 12/07/02 200207670

On 12/07/02 at about 1525 hours, I was assigned to assist Hoopa Tribal Police Officer O'Rourke with an unwanted subject in the Masten Flat area. I telephoned Sheriff's Dispatch and requested a warrant check on the subject, ██████████ ██████████

Sheriff's Dispatch told me that ██████████ did indeed have two outstanding citable warrants.

I arrived at about 1540 hours and saw Officer O'Rourke standing near a subject who was sitting on the ground with his legs folded and his arms were wrapped around his stomach.

I approached the subject, who Officer O'Rourke identified as ██████████ ██████████ and attempted to speak with ██████████ ██████████ refused to speak with me.

I next spoke with Officer O'Rourke, who told me that he had arrived shortly before me and found ██████████ sitting in the driveway. Officer O'Rourke also attempted to speak with ██████████ but also received no reply.

While I was speaking with Officer O'Rourke, I noticed ██████████ was breathing heavily, and sweating profusely. I could not smell any odor of an alcoholic beverage on or about ██████████ person. Due to the fact that ██████████ would not speak with me, I could not serve the citable warrants. Officer O'Rourke and I placed ██████████ into handcuffs and sat him in the rear seat of my patrol car to transport him to the Humboldt County Sheriff's Hoopa Substation for the outstanding warrants. While ██████████ was sitting in my car, he looked at me and stated, "request backup." I asked ██████████ to repeat what he had said. ██████████ then said, "I'm sticking to what I said."

When I arrived at the substation, ██████████ had to be carried into the substation,

HUMBOLDT CO SHERIFF
INCLUSIVE CASE REPORT

Date: 6/5/2007

Page: 2

Case Number
200207670

as he would not move on his own. [REDACTED] continued to drag his feet and when his two outer coats were removed, I saw that his thermal shirt and t-shirt were soaked with sweat. I believed [REDACTED] may have medical problems due to his lack of cooperation and I contacted an ambulance.

Hoopa Ambulance arrived and evaluated [REDACTED] Paramedic Appalar believed [REDACTED] might be under the influence of a controlled substance. Paramedic [REDACTED] stated that [REDACTED] needed to be transported to a hospital for a possible overdose. I released [REDACTED] to Paramedic [REDACTED] for transportation and treatment. Officer O'Rourke stated that he would serve the warrants when [REDACTED] returned home.

Nothing further.

Officer - IR 1334 HICKS CORY

Report Date 12/7/2002

Supervisor Review 0616 MOREY DAVID M

Review Date 12/9/2002

Distribution _____

HUMBOLDT CO SHERIFF
INCLUSIVE CASE REPORT

Date: 6/5/2007

Page: 1

Case Number
200203187

Incident Case Number 200203187 IR Title TRAFFIC/WARRANT ARREST
Date/Time Occurred 6/1/2002 2:10:23 AM IR Date/Time 6/1/2002 3:22:24 AM
Name/Business Name _____ Incident Location U:S MARSHALL LN, HOOPA, CA
Case Clearance _____ Case Clearance Date _____

Offense

Offense Code INV CSA COMMITTED Location STREET OR SIDEWALK
Description _____

Person

Person Type INVOLVED PERSON
Name Type LEGAL Last ██████████ First ██████████ Middle ██████████
Address Type OTHER Address ██████████ Apartment _____
City HOOPA State CALIFORNIA Zip 95546 Phone _____
DOB ██████████ Age 21 Sex MALE Race WHITE Height 511 Weight 160
Hair Color BROWN Eye Color BROWN Driver License _____ State _____

Vehicle

Veh No 1 Type AUTOMOBILE Top Color _____ Bottom Color _____ Year ██████████
Make FORD Model _____ License ██████████ State CALIFORNIA Expires 2001
VIN ██████████ Vehicle Description _____

Narrative/Summary

Narrative - IR On 6/01/02 at about 0210 hours, I was patrolling the downtown Hoopa area in a marked patrol unit. I saw a brown car traveling N/B SR 96 with a broken taillight. I followed the vehicle N/B SR 96 approaching Hostler Creek Rd, where I initiated traffic stop on the vehicle using my overhead emergency lights. The vehicle yielded and stopped on S/ Marshall lane in Hoopa.

Deputy Dean and Hoopa Tribal Police Sergeant Yarborough arrived shortly after I conducted a traffic stop on the vehicle.

I spoke with the driver who identified himself as ██████████ I explained to ██████████ that I stopped him for his broken taillight. I radioed dispatch for a warrant check on ██████████ Dispatch advised that ██████████ had an outstanding warrant for his arrest.

I took ██████████ into custody and escorted him to Deputy Deans patrol unit. Deputy Dean transported ██████████ to Lord Ellis summit where he met with Sergeant Parton who transported ██████████ to Humboldt County Correctional Facility to be booked on the warrant.

I radioed dispatch for a tow truck to my location.

Buddy's Tow arrived and towed ██████████ vehicle to Buddy's Auto in Willow Creek where his vehicle was stored. ██████████ vehicle was stored for VC-22651(h) (1) Driver arrested.

**HUMBOLDT CO SHERIFF
INCLUSIVE CASE REPORT**

Date: 6/5/2007

Page: 2

Case Number
200203187

Attachments:

CHP 180.

End Report.

Officer - IR 1333 BROOKS DAVID

Report Date 6/1/2002

Supervisor Review 0616 MOREY DAVID M

Review Date 6/3/2002

Distribution _____



EUREKA POLICE DEPARTMENT
604 C Street
Eureka, California 95501
(707) 441-4060

FAX COVER PAGE

TO: Fax to number: 445-7434

Agency Name: HCSO

Attention: DET. BEN NORD

Date: 6/5/02 Number of Pages (including this page) 11

FROM: Sender Name KATHY-RECORDS

Telephone (707) 441-4071 Fax Number (707) 441-4334

COMMENTS: 3607-4282

RE: [REDACTED]

HARD COPY TO FOLLOW TOMORROW.

This message is intended for the use of the individual or entity to which it is addressed, and may contain information that is privileged and confidential. If you are not the intended recipient, or the agent responsible for delivering the message to the intended recipient, you are hereby notified that any dissemination, distribution or copying of this communication is strictly prohibited. If you have received this communication in error, please notify us immediately by telephone and return the original message to us at the above address and destroy the original message. Thank you.

EUREKA POLICE DEPARTMENT

604 C Street
Eureka, CA 95501
CA0120300

- DOMESTIC VIOLENCE
CHILDREN: INVOLVED PRESENT N/A
 GANG RELATED HATE CRIME

INCIDENT INFORMATION

DATE OCCURRED 5-26-07	THRU	TIME OCCURRED	THRU
REPORT DATE 5-26-07	REPORT TIME	DAY OF WEEK SAT	
COMMON NAME / BUSINESS NAME Humboldt Co. Mental Health			
INCIDENT LOCATION (Address or Block Range) 720 WOOD STREET			
ST.		Apt. / Suite No.	
LOCATION TYPE *3 HOSPITAL			BEAT 3

CASE NUMBER 3007-4282	PAGE 1 OF
PRIMARY OFFENSE PC 594 (b)(5) MAL MISCH	1. FELONY 2. MISD. 3. INFRACTION 4. INCIDENT
OTHER OFFENSES	

UNIFORM CRIME REPORT

UCR WEAPON TYPE *5			
1. Revolver	4. Shotgun	7. Other Weapon	10. Machine Gun
2. Semi-Auto Pistol	5. Knife-Cut. Inst.	8. Simulated Weapon	11. Unknown
3. Rifle	6. Hand/Feet/Inst	9. Assault Rifle	
FORCED ENTRY			
1. Yes	2. No	3. Unknown	
ENTRY LOCATION *8			
1. Window-Front	5. Window-Up Level	8. Door-Side	13. Roof
2. Window-Rear	6. Window-Basement	9. Door-Up Level	14. Wall
3. Window-Side	7. Door-Front	10. Door-Garage	15. Adjoin. Area
4. Window-Wing	8. Door-Rear	11. Door-Basement	16. Other

PERSON INFORMATION

<input type="checkbox"/> SEX CRIME CONFIDENTIALITY	SUBJECT NO.	<input checked="" type="checkbox"/> VICTIM (3)	LAST NAME COUNTY OF HUMBOLDT	FIRST	MIDDLE	ADDRESS NO.	STREET 720 WOOD ST	(APT.)
CITY EUREKA	STATE CA	ZIP 95503	DATE OF BIRTH	HOME PHONE () -		EMPLOYER NAME	ADDRESS	WORK PHONE () 476-4094
SEX 1. Male 2. Female	RACE **1	1. Other Asian 2. Black 3. Chinese	4. Cambodian 5. Filipino 6. Guamanian	7. Hispanic 8. Am. Indian 9. Japanese	10. Korean 11. Laotian 12. Other	13. Pacific Islander 14. Samoan 15. Hawaiian	16. Vietnamese 17. White 18. Asian Indian	

PERSON INFORMATION

<input type="checkbox"/> SEX CRIME CONFIDENTIALITY	SUBJECT NO.	<input type="checkbox"/> VICTIM (3)	<input checked="" type="checkbox"/> REPORTING PARTY (1)	<input type="checkbox"/> WITNESS (8)	ADDRESS NO.	STREET 720 WOOD ST	(APT.)
CITY EUREKA	STATE CA	ZIP 95503	DATE OF BIRTH	HOME PHONE ()	EMPLOYER NAME	ADDRESS	WORK PHONE ()
SEX 1. Male 2. Female	RACE **1	1. Other Asian 2. Black 3. Chinese	4. Cambodian 5. Filipino 6. Guamanian	7. Hispanic 8. Am. Indian 9. Japanese	10. Korean 11. Laotian 12. Other	13. Pacific Islander 14. Samoan 15. Hawaiian	16. Vietnamese 17. White 18. Asian Indian

CONTROLLED DOCUMENT

DUPLICATION OR REISSUANCE CONTROLLED BY LAW

INVOLVED (14) DET. BEN NORD

Released to: HCSO

By: ODDITY RP Date: 6/2/09

Eureka Police Department

VEHICLE INFORMATION

<input type="checkbox"/> VICTIM (12)	<input type="checkbox"/> INVESTIGATIVE LEAD (13)	STATE VEHICLE TYPE *2B	TOP COLOR *176	YEAR	MAKE
1. Auto	7. Boat	1. Auto	2. Truck	3. Motorcycle	4. Camper
5. Bus	6. Trailer	8. Aircraft	9. Other		
BOTTOM COLOR *176	LICENSE NO.	STATE	TABLE **17	1. Arson AMT. 5	

STOLEN PROPERTY LIST

CODE	ITEM NO.	ARTICLE	BRAND / MODEL	QTY.	DESCRIPTION	SERIAL NO.	VALUE	NCIC
D	1	CAMERA	SONY	1	SURVEILLANCE CAMERA		500	
D	2	PHONE CORD		1	MULTI-PHONE/LINE PHONE CORD		150	

OFFICER S. J. [Signature]	IBM NO. JH3	REPORT DATE 5-26-07	SUPERVISOR REVIEW [Signature]	IBM NO. JH3	REVIEW DATE 5-26-07
------------------------------	----------------	------------------------	----------------------------------	----------------	------------------------

CR 1 - REVISED 2/07

NO. 1

INFORMATION (4)

EPD NO.	LAST NAME (SEE ARREST PAGE)	FIRST	MIDDLE	ADDRESS ST. NO.	STREET	(APT.)		
CITY	STATE	ZIP	DATE OF BIRTH	HOME PHONE	()			
DRIVERS LICENSE NO.	LIC. STATE	OCCUPATION						
EMPLOYER	ADDRESS					WORK PHONE		
RACE **1 1. Other Asian 2. Black 3. Chinese 4. Cambodian 5. Filipino 6. Guamanian 7. Hispanic 8. Am. Indian 9. Japanese 10. Korean 11. Laotian 12. Other 13. Pacific Islander 14. Samoan 15. Hawaiian 16. Vietnamese 17. White 18. Asian Indian						HEIGHT Ft. In.	WEIGHT Lbs. Lbs.	SEX 1. Male 2. Female
HAIR COLOR **3	EYE COLOR **3	BODY MARKS **7						
CLOTHING/PHYSICAL DESCRIPTION								

CHECK FOR ADDITIONAL SUSPECT(S)

RELATIONSHIP OF PERSON(S)

VICTIM TO SUSPECT TABLE 1

Undetermined Stranger Friend Acquaintance Spouse	Former Spouse Co-Habitant Roommate Same Sex Relationship Parent	Child Step-Parent Step-Child Brother/Sister In-Law	Other Family Boyfriend/Girlfriend Child of boyfriend/Girlfriend Step/Day Care Student	Teacher Neighbor Employer Co-Worker	Landlord/Tenant Police Officer
VICTIM ONE N/A	SUSPECT ONE				RELATIONSHIP

CHECK FOR ADDITIONAL PERSON RELATIONSHIP(S)

RELATIONSHIP OF OFFENSE (ASSAULTS/VIOLENCE)

HOMICIDES Murder Murder Attempt Manslaughter Manslaughter Involuntary	SEXUAL ASSAULTS Rape Sex Assault (Not Rape) Sex Assault Child Indecent Exposure	ROBBERIES Robbery	CRIME/OFFENSE TABLE 2 OTHER ASSAULTS Assault: Firearm Assault: Other Deadly Weap. Assault: Domestic Violence Assault: Simple Assault: And Battery Assault: Hate Crime	Assault: On Police Officer Resist Arrest Interfere With Police Threats: General Threats: Bomb Threat	Annoying Phone Calls Child Abuse Child Neglect Child Sealing/Custody Elder Abuse Elder Neglect	Arson: Bodily Injury Arson: Inhabited Dwelling Brandishing: Firearm Brandishing: Other
VICTIM ONE N/A	SUSPECT ONE			OFFENSE		

CHECK FOR ADDITIONAL OFFENSE RELATIONSHIP(S)

NARRATIVE:

(SEE ATTACHED NARRATIVE)

2. _____

3. _____

4. _____

5. _____

6. _____

7. _____

8. _____

9. _____

10. _____

11. _____

CHECK FOR ADDITIONAL NARRATIVE

1. Cleared by Arrest 2. Cleared and released 3. Book Cit Rel. 4. PC 849B 5. Unfounded	6. Documentation 7. Cleared; Admin. 8. Open 9. Closed 10. Suspended	11. Cleared: Recovery 12. Cleared: Partial Recov. 13. Cleared: Other Agency 14. Cleared: Resolution 15. Warrant Requested	STATUS **1 16. To: Property Clerk 17. To: D.A. 18. To: Other Agency 19. Owner Notified 20. Released: Medical	21. Cleared: Court Book 22. Cleared: Extradition 23. To: CID 24. To: NOP 25. To: POP	26. Cleared: Other Charge
DISTRIBUTION: 1. Briefing 2. CID 3. P.A. 4. Parole 5. Probation 6. CPS 7. Coroner 8. ABC 9. Other 10. Gang Unit					COPIES BY:

5/29/02

EUREKA POLICE DEPARTMENT
Arrest Page

SUBJECT NO. 367-4282 PAGE **1**
 OF

- STATE OF CALIFORNIA
 - CITY OF EUREKA
 - ARREST
 - BOOK / CITE / RELEASE
 - CITE ONLY
- ADULT
 - JUVENILE

PRIMARY OFFENSE PC 594(C)(3) MAJ MISCH	<input checked="" type="checkbox"/> 1. FELONY <input type="checkbox"/> 2. MISDEMEANOR <input type="checkbox"/> 3. INFRACTION
OTHER OFFENSES	
CITATION NO.	

INCIDENT INFORMATION

DATE OCCURRED 5-26-07	TIME OCCURRED 0900	DATE ARRESTED 5-26-07	TIME ARRESTED 0930
COMMON NAME / BUSINESS NAME HAMB CO. MENTAL HEALTH			
LOCATION: (Address or Block Range) 720 WOOD ST		APT./SUITE	BEAT 3
LOCATION TYPE *3 HOSPITAL			

OFFICE USE ONLY

TYPE OF ARREST * 186 _____
 STATE DISPOSITION * 116 _____
 UCR OFFENSE STATUS * 9 _____
 DEPARTMENT CLASSIFICATION * 217 _____

ARRESTEE INFORMATION

EMPLOYER/BUSINESS ADDRESS			BUSINESS PHONE ()		
1. Other Asian		4. Cambodian		7. Hispanic	
2. Black		5. Filipino		8. Indian	
3. Chinese		6. Guamanian		9. Japanese	
10. Korean		11. Laotian		12. Other	
13. Pacific Islander		14. Samoan		15. Hawaiian	
16. Vietnamese		17. White		18. Asian Indian	
HAIR COLOR *38 BLK		EYE COLOR *38 BRN		BODY MARKS *170	
CLOTHING: / OTHER PHYSICAL DESCRIPTION BLACK TRENCH COAT, BLACK JEANS, LTRN SHIRT, BLACK LEATHER BOOTS					
<input type="checkbox"/> ALIAS		LAST NAME		FIRST NAME	
<input type="checkbox"/> MONIKER		MIDDLE NAME		D.O.B.	
				EPD NUMBER	

ARRESTEE VEHICLE

STATE VEHICLE	TYPE *28	TOP COLOR *176	VEHICLE YEAR	MAKE OF VEH. *173	MODEL
1. Auto	7. Boat				
2. Truck	8. Aircraft				
3. Motorcycle	9. Other	BOTTOM COLOR *176	LICENSE NO.	STATE	VEHICLE ODDITY
4. Camper					
5. Bus					
6. Trailer					

THE SUBJECT WAS FOUND IN A PUBLIC PLACE UNDER THE INFLUENCE OF: ALCOHOL
 DRUGS
 ANY COMBINATION THEREOF

AT _____

The subject displayed the below listed objective signs of being under the influence to such a degree that he/she could not care for his/her own welfare or the welfare of others. Therefore, the subject was taken into custody.

OBJECTIVE SIGNS (Under the influence Alcohol/Drugs)

SPEECH <input type="checkbox"/> Slurred <input type="checkbox"/> Repetitive <input type="checkbox"/> Slow/Thick <input type="checkbox"/> Rapid <input type="checkbox"/> Other	ODOR: ALCOHOL <input type="checkbox"/> Heavy <input type="checkbox"/> Moderate <input type="checkbox"/> Light	EYES <input type="checkbox"/> Bloodshot <input type="checkbox"/> Watery <input type="checkbox"/> Glassy <input type="checkbox"/> Dilated <input type="checkbox"/> Constricted	BALANCE <input type="checkbox"/> Sway <input type="checkbox"/> Stagger <input type="checkbox"/> Unable to stand unassisted <input type="checkbox"/> Unconscious <input type="checkbox"/> Other	CLOTHING <input type="checkbox"/> Urinated on self <input type="checkbox"/> Vomited on self <input type="checkbox"/> Disheveled <input type="checkbox"/> Dirty <input type="checkbox"/> Neat/Clean	ATTITUDE <input type="checkbox"/> Belligerent <input type="checkbox"/> Physically Resistant <input type="checkbox"/> Attitude fluctuated without reason
-----------------------------------------------------------------------------------------------------------------------------------------------------------------------------------------------------	-------------------------------------------------------------------------------------------------------------------------------	-----------------------------------------------------------------------------------------------------------------------------------------------------------------------------------------------------	----------------------------------------------------------------------------------------------------------------------------------------------------------------------------------------------------------------------	--------------------------------------------------------------------------------------------------------------------------------------------------------------------------------------------------------------------------	-------------------------------------------------------------------------------------------------------------------------------------------------------------------------

NARRATIVE / WARRANT(S):
 Warrant number _____ Court _____

OFFICER CAOS	IBM NO. 0113	REPORT DATE 5-26-07	SUPERVISOR REVIEW [Signature]	IBM NO. 0113	REVIEW DATE 5-26-07
------------------------	------------------------	-------------------------------	-----------------------------------------	------------------------	-------------------------------

NARRATIVE:

- 2.
- 3.
- 4.
- 5.
- 6.
- 7.
- 8.
- 9.
- 10.
- 11.
- 12.
- 13.
- 14.
- 15.
- 16.
- 17.
- 18.
- 19.
- 20.
- 21.
- 22.
- 23.
- 24.
- 25.
- 26.
- 27.
- 28.
- 29.
- 30.
- 31.
- 32.

CONTROLLED/CONFIDENTIAL

1. Cleared By Arrest		4. PC 849B		7. Administratively Closed		10. Suspended		13. Cleared By Other Agency		16. To Property Clerk		19. Owner Notified	
2. Cited And Released		5. Unfounded		8. Open		11. Cleared By Recovery		14. Cleared By Restitution		17. Referred To D.A.			
3. Book Cite Released		6. Documentation Only		9. Closed		12. Cleared By Partial Recov.		15. Warrant Requested		18. Referred Other Agency			
OFFICER				IBM NO.		DATE OF REPORT				SUPERVISOR REVIEW			
DISTRIBUTION:												COPIES BY:	
<input type="checkbox"/> Briefing <input type="checkbox"/> Investigation <input type="checkbox"/> D.A. <input type="checkbox"/> Parole <input type="checkbox"/> Probation <input type="checkbox"/> CPQ <input type="checkbox"/> Coroner <input type="checkbox"/> ABC <input type="checkbox"/> Other													

EPD A1.2 REV 2/10/84

1 **CLASSIFICATION:** PC 594(b)(1) Malicious Mischief

2
3 **VICTIM:** County of Humboldt

4 [REDACTED]
5 [REDACTED]
6
7 **REPORT:**

8 On 5/26/07 at about 0915 hours I was dispatched to Humboldt County Mental Health
9 [REDACTED] regarding a [REDACTED] causing a disturbance and throwing chairs and other
10 furniture around the intake unit. He was locked in the intake room by himself, so no one
11 else was in danger.

12
13 Officers Liles and Cooper responded to assist me. Upon arrival I spoke to W [REDACTED]
14 She explained that [REDACTED] had been transported to [REDACTED] via ambulance because he had
15 been placed on a [REDACTED] by the Hoopa Tribal Police. He arrived at about 0630
16 hours. The [REDACTED] staff did a [REDACTED] on him and he came back [REDACTED]
17 [REDACTED] [REDACTED]
18

19 The unit psychologist, Dr [REDACTED], told me that in his opinion [REDACTED] did not
20 meet the criteria for [REDACTED], but was suffering from [REDACTED], and possible
21 [REDACTED]
22

23 Prior to our arrival he had been ranting and yelling at the staff, posturing and challenging
24 them to fight. He then started throwing chairs around the room. He ripped a Sony
25 surveillance camera from the wall, and pulled a thick multi-line phone cord out of the
26 wall causing damage to it and the wall.

27
28 The staff indicated that he was not on a [REDACTED] and asked that he be prosecuted for
29 damaging the camera and phone cord. Officers Liles and Cooper handcuffed [REDACTED]
30 while I covered him with a taser. He was cuffed without incident.

31
32 I transported [REDACTED] to the HCCJ where he was booked for the felony vandalism. Ofc
33 Cooper took digital photos of the damage to the camera and phone. The photos were
34 booked into evidence and copies are attached.

35
36 Cleared by arrest.

Sgt J.S. Armstrong

05/26/07

Approved

CASE NUMBER: 3607-4282

PAGE _____
OF _____

ASSOCIATED CASE: _____

**EUREKA POLICE DEPARTMENT
PROPERTY / EVIDENCE BOOKING AND RELEASE REPORT**

- PROPERTY CODES * 17B
 S - Stolen
 R - Recovered for Return
 RA - Recovered (For Other Agency)
 RE - Recovered Evidence
 F - Found
 D - Damaged
 L - Lost
 E - Evidence
 K - Safekeeping
 C - Contraband For Disposal

DATE STORED <u>5-26-07</u>	TIME STORED <u>1515</u>	DATE OF INCIDENT <u>5-26-07</u>	CRIME <u>PC 594(B)(1)</u>
(VICTIM) LAST NAME <u>COUNTY OF HUMBOLDT</u>	FIRST <u></u>	MIDDLE <u></u>	ADDRESS <u></u>
(FINDER) LAST NAME <u></u>	FIRST <u></u>	MIDDLE <u></u>	ADDRESS <u></u>
LOCATION PROPERTY WAS FOUND / INCIDENT OCCURRED (LOCATION TYPE 3) <u>720 WOOD ST ECA</u>			

- ADULT ARREST
 JUVENILE ARREST
 SEARCH WARRANT # _____
 PROPERTY CLAIMED BY FINDER
 FIELD PROPERTY RECEIPT PROVIDED

PROPERTY / EVIDENCE LISTING

CODE	ITEM NO.	ARTICLE	BRAND/MODEL	QTY.	DESCRIPTION	SERIAL NO.	VALUE	ENTERED NCIC	LAB WORK	STORAGE LOCATION	DISPOSITION
E	1	PHOTOS		6	DIGITAL PHOTOS						

CONTROLLED/CONFIDENTIAL

PROPERTY/EVIDENCE ASSOCIATED TO

ITEMS NO.	<input type="checkbox"/> SUSPECT <input type="checkbox"/> OWNER	LAST	FIRST	MIDDLE	DOB	ADDRESS	PHONE	NOTIFIED
ITEMS NO.	<input type="checkbox"/> SUSPECT <input type="checkbox"/> OWNER	LAST	FIRST	MIDDLE	DOB	ADDRESS	PHONE	NOTIFIED
ITEMS NO.	<input type="checkbox"/> SUSPECT <input type="checkbox"/> OWNER	LAST	FIRST	MIDDLE	DOB	ADDRESS	PHONE	NOTIFIED
ITEMS NO.	<input type="checkbox"/> SUSPECT <input type="checkbox"/> OWNER	LAST	FIRST	MIDDLE	DOB	ADDRESS	PHONE	NOTIFIED

REQUEST FOR LAB EXAMINATION

ITEMS NO.	PURPOSE OF EXAMINATION	<input type="checkbox"/> YES PRESUMPTIVE TEST COMPLETED	DATE	BY	AGENCY DELIVERED TO	DATE	DELIVERED BY
ITEMS NO.	PURPOSE OF EXAMINATION	<input type="checkbox"/> YES PRESUMPTIVE TEST COMPLETED	DATE	BY	AGENCY DELIVERED TO	DATE	DELIVERED BY
ITEMS NO.	PURPOSE OF EXAMINATION	<input type="checkbox"/> YES PRESUMPTIVE TEST COMPLETED	DATE	BY	AGENCY DELIVERED TO	DATE	DELIVERED BY

BOOKING OFFICER <u>[Signature]</u>	IB# NO. <u>5413</u>	REPORT DATE <u>5-26-07</u>	SUPERVISOR REVIEW <u>[Signature]</u>	IB# NO. <u>2113</u>	REPORT DATE <u>5-26-07</u>
---------------------------------------	------------------------	-------------------------------	-----------------------------------------	------------------------	-------------------------------

06/05/2007 09:53 7074414334 EUREKA PD PAGE 07/11

Humboldt County Sheriff's Office

826 Fourth Street, Eureka, CA 95501

Date: June 04, 2007

From: Brenda Godsey, PIO
(707) 268-3645

Subject: Hoopa Stand-Off

Case: 200703162

FOR IMMEDIATE RELEASE

Yesterday afternoon at about 2:00, a Humboldt County Sheriff's Deputy and an officer from the Yurok Department of Public Safety were called to a residence on Pine Creek Road in Hoopa to conduct a welfare check. At about 3:30 p.m. officers arrived at the residence and were approached by a concerned party told them that the individual inside the residence was agitated and might be in possession of knives or guns. As they were speaking, a man stepped from the residence and aimed a firearm at the deputies. The deputies took cover and called for additional officers. Law enforcement personnel moved civilians out of the area and secured the scene. At about 6:30 p.m. the suspect fired approximately three shots, hitting two Hoopa Tribal patrol vehicles.

The Humboldt County Sheriff's Office called out its Crisis Response Team, consisting of a tactical weapons unit and a hostage negotiations unit.

Officers from the Hoopa Valley Tribal Police Department, the California Highway Patrol, and Eureka Police Department's SWAT Team also arrived to assist.

Trained negotiators worked throughout the night in an attempt to persuade the suspect to surrender. Those efforts were unsuccessful.

Early this afternoon, teargas was introduced into the residence in an effort to force the man from the house. All of the agents introduced into the residence were non-pyrotechnic agents.

At about 2:45 p.m. law enforcement personnel saw smoke and flames coming from one corner of the residence. Officers also heard gunshots coming from the house and were, therefore, unable to safely approach or make entry. Additionally, the subject was not communicating with law enforcement. The structure became fully engulfed and it is believed the subject never exited the structure.

The Humboldt County Critical Response Team and investigators from the Arson Task Force are investigating the incident.

Additional information will be released as it becomes available.

GARY PHILP
Sheriff

#####

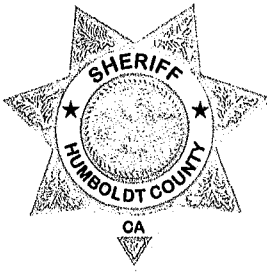

**Humboldt County Sheriff's Office
Criminal Investigation Division
Supplemental Report**

CASE: 2007-3162

INVESTIGATOR: Sergeant Wayne Hanson

DATE: 06-04-2007

CRIME: Officer Involved Shooting

[REDACTED] State of California

[REDACTED] [REDACTED] [REDACTED]
LOCATION: Bloody Camp Road/ [REDACTED], Hoopa

**Witness: Sergeant Mike Fridley
Humboldt County Sheriff's Office
Address: 826 4th Street, Eureka
Telephone 530-625-4231**

Witness: [REDACTED]

Witness: [REDACTED]

Witness: [REDACTED]

Witness: [REDACTED]

Witness: [REDACTED]

Witness: [REDACTED]

Witness: [REDACTED]

Witness: [REDACTED]

On Sunday, 06-03-2007 in the early evening hours, Lt. Cavinta contacted me by telephone at my residence. Lt. Cavinta advised me that there had been an officer involved shooting at residence located off Bloody Camp Road, Hoopa. Lt. Cavinta told me that the [REDACTED] had shot at several of our deputies. Lt. Cavinta advised me that several of our deputies had shot back at [REDACTED]. Lt. Cavinta told me that [REDACTED] was now barricaded inside of a residence. Lt. Cavinta told me that our Special Enforcement Team was on scene along with other officers from other agencies.

Lt. Cavinta said that Detective Schlesiger was on scene with him as the lead detective in this incident. Lt. Cavinta was requesting that I contact a second detective to respond to his location to assist Detective Schlesiger with the investigation. Lt. Cavinta requested that I respond in the morning with another detective to assist in the investigation. I then contacted Detective Steve Quenell at his residence and requested that he respond tonight to assist Detective Schlesiger at the scene.

I then contacted Detective Marvin Kirkpatrick at his residence and advised him to meet me at our office in Eureka at 0700 hours on Monday, to respond with me to Hoopa. On 06-04-2007 at approximately 0700 hours, Detective Kirkpatrick and I met at our office in Eureka. We then both responded to the Hoopa area in the same vehicle. When I arrived in the Willow Creek area, I spoke to Detective Schlesiger on his cellular telephone. Detective Schlesiger requested that we respond to the Sheriff's Office, Hoopa Station and contact [REDACTED] who is [REDACTED] mother. Detective Schlesiger told me that

██████████ knew where her son, ██████████ was currently staying. Detective Schlesiger requested that I contact ██████████ for a statement, regarding his brother ██████████ ██████████

At approximately 0900 hours, ██████████ arrived at our Hoopa office in her vehicle. Detective Kirkpatrick and I then followed ██████████ in her vehicle to a residence located off Matsen Flat, Hoopa.

Detective Kirkpatrick and I then contacted ██████████ inside of a residence. We then spoke to ██████████ in the kitchen area of the residence at 0910 hours. I recorded our conversation with ██████████ on a digital recorder. I later transferred our interview to a CD-R, which I later booked into evidence. The following is a summary of what ██████████ relayed to us about his brother, ██████████

██████████ told us that ██████████ was up on Bald Hill, freaked out and scared. I asked ██████████ when was the last time he saw his brother ██████████ ██████████ told me that he saw ██████████ Saturday night at his house and he spent the night. ██████████ said that ██████████ was acting a little crazy. ██████████ told us that ██████████ was off ██████████ and was a little confused. I asked ██████████ what he meant by a little crazy. ██████████ said that he was walking back and forth in his house. ██████████ said that ██████████ cut up his wet suit with a kitchen knife. ██████████ said that ██████████ put on his wristwatch and put a lot of his clothes on.

██████████ said that ██████████ was not acting normal when he came over Saturday night to his residence. I asked ██████████ if he had seen his brother, ██████████ act like this before. ██████████ said, yes but not this bad. I asked ██████████ if his brother was saying anything to him. ██████████ said ██████████ would not talk to him. ██████████ said that he had to yell, ██████████ do you hear me. ██████████ said that ██████████ would mostly look down at the ground and would not answer him. ██████████ said that ██████████ did tell him that I am your brother the cat.

I asked ██████████ prior to Saturday night when was the last time he had spoken to ██████████ when he was normal. ██████████ said that he saw ██████████ 4 or 5 days before Saturday night and he was not as bad. ██████████ told me that his brother, ██████████ is never completely normal.

I asked ██████████ if ██████████ was drinking alcohol when he saw him Saturday night or Sunday morning. ██████████ told me he did not see him drinking alcohol, Saturday or Sunday. I asked him if he was smoking marijuana or taking other drugs. ██████████ told me he did not know.

I asked ██████████ how he knew that ██████████ was not ██████████. ██████████ told me that ██████████ told him ██████████

██████████ told me that on Sunday morning at approximately 1030 to 1100 hours he gave ██████████ a ride to his Mother's house and his mother called ██████████ because ██████████ was not himself. ██████████ said that ██████████ told him that he did not want to go back to ██████████ ██████████ said that ██████████ was getting angry about going ██████████.

██████████ said that ██████████ acted like he was going to spit on his mother. ██████████ said that he grabbed ██████████ and threw him into his truck.

██████████ said that he then gave ██████████ a ride over to ██████████ house located off Highway 96 in the middle of Shoemaker Road. I asked ██████████ why ██████████ wanted to go to ██████████ house and he told me to get his guitar and amp. ██████████ said he then drove ██████████ over to ██████████ house and left him there. I asked ██████████ if ██████████ had access to any guns. ██████████ told me that ██████████ did not have any guns that he is aware of.

I asked ██████████ if ██████████ has ever threatened to hurt himself or someone else in the past. ██████████ told me that the first time that ██████████ went to ██████████ he was going to kill himself. I asked ██████████ if he was present when ██████████ threatened to kill himself. ██████████ told me ██████████ had a loaded 12-gauge shotgun in his hands and place the barrel of the shotgun into his mouth at his Mother's house a couple of years ago. ██████████ said that he grabbed the shotgun out of ██████████ hands. I asked ██████████ if the shotgun was loaded and he told me, yes. I asked ██████████ why ██████████ wanted to kill himself with the shotgun. ██████████ said he did not know why he wanted to hurt himself.

I asked ██████████ how ██████████ got the shotgun. ██████████ said that there father gave it to ██████████ as a Christmas gift when he was 12 years old. I asked ██████████ where the shotgun was now at and he told me that the police took it when this happened.

I then ended my interview with ██████████

I then responded to ██████████ residence after I left ██████████ residence, but ██████████ was not at home. I did locate ██████████ at his residence on Monday, 06-11-2007 for a statement.

Detective Kirkpatrick and I were able to contacted ██████████ on 06-11-2007 at 1015 hours at his residence. I used a digital recorder to record our conversation. I later transferred that interview to a CD-R, which I booked into evidence. The following is a brief summary of what ██████████ relayed to me about this investigation.

I asked ██████████ if he saw ██████████ a week ago Sunday at his residence. ██████████ told me that ██████████ was not ██████████ and was acting bazaar when he saw him on Sunday at 1200 hours at his house. I asked ██████████ how ██████████ came to his house on Sunday. ██████████ told me he walked there. I asked ██████████ how he new that ██████████ was ██████████. ██████████ said he has know ██████████ all of his life and he knows when he is ██████████. I asked ██████████ what ██████████ was wearing on Sunday and he told me a trench coat. ██████████ told me he asked ██████████ to leave, because he was being loud around his kids. ██████████ said when ██████████ left he walked away from his residence.

I then ended my conversation with ██████████

Detective Kirkpatrick and I then responded to the Incident Command Post located off Bloody Camp Road, Hoopa. I contacted Lt. Cavinta and Detective Schlesiger. I was

briefed by Lt. Cavinta of the situation. Lt. Cavinta advised me that [REDACTED] was still inside of a residence and Sgt. Mike Fridley was attempting to contact [REDACTED] via a patrol vehicle's external broadcast system. Lt. Cavinta advised me that the Sheriff's Office Special Enforcement Team, Eureka Police Department's tactical team and the California Department of Corrections tactical team were on scene with a perimeter set up around the residence.

Detective Schlesiger requested that I attempt to contact any neighbors in the area that may witnessed any of the situation involving this incident with [REDACTED]. Detective Schlesiger also requested that I attempt to locate two [REDACTED] with the last name of [REDACTED] that might have seen [REDACTED] on Sunday. Detective Schlesiger said that the [REDACTED] may live a mile or so further up Bloody Camp Road. I then stayed on scene at the Command Post for the rest of the time.

At approximately 1840 hours, Deputy [REDACTED] and I began to check with the neighbors in the area to see what they may have witnessed regarding this incident.

I drove down to a dirt road, which is located just south below [REDACTED] property. I contacted the occupants of that residence, who I identified as [REDACTED] and his wife [REDACTED]. They told me that their address is [REDACTED] Hoopa, because they do not want to use the name [REDACTED] as their address. I used a digital recorder to record our conversations. I later transferred my interview to a CD-R, which I booked into evidence. The following is a brief summary of what they relayed to me about this investigation.

Both [REDACTED] told me that both left to go out of town on Friday, June first at 1930 hours and returned home on Monday, June 4th at 0130 hours. Both [REDACTED] told me that they had no idea on what may have transpired at [REDACTED] residence, which is located to the north above their residence. I then ended my conversation with the [REDACTED]

I then returned the scene at 2000 hours and secured the residence and property with Sergeant Buhiner and Deputy Peterson, until Detective Marvin Kirkpatrick, EPD Detective Kevin Lawson, ID Tech [REDACTED] and Arson Task Force members arrived in the morning on Tuesday, 06-05-2007 to start their investigation.

On 06-05-2007 at 0830 hours, I went to another neighbor's residence, which is located just to the west of the [REDACTED] residence. I contacted [REDACTED] at the residence, who told me that he lived here with his wife [REDACTED] and their 5-year-old daughter. [REDACTED] told me that his wife and daughter were not currently home. I used a digital recorder to record our conversations. I later transferred my interview to a CD-R, which I booked into evidence. The following is a brief summary of what [REDACTED] [REDACTED] relayed to me about this incident.

[REDACTED] told me that on Sunday, he received telephone calls from friends, who were listening to police scanners. [REDACTED] told me that those friends told him that the police were

at his neighbor's, [REDACTED] house. [REDACTED] told me that in the evening hours on Sunday, Hoopa Tribal Police and a Deputy Sheriff came to his residence to evacuate him, because shots were fired at [REDACTED] property. [REDACTED] said police officers came to his house at about 2100 hours. [REDACTED] said he told those officers to be careful, because he has heard automatic gunfire coming from [REDACTED] property in the past. [REDACTED] said those officers told him that they had a possible [REDACTED] [REDACTED] inside of [REDACTED] house.

I asked [REDACTED] if he heard shots being fired at [REDACTED] property on Sunday. [REDACTED] told me that he hears gunshots all the time at the [REDACTED] property. [REDACTED] did tell me on Sunday, he heard 4 or 5 gunshots coming from the [REDACTED] property in the afternoon. [REDACTED] said he was unsure on what time he heard the gunshots on Sunday. [REDACTED] said that the gunshots came one after the other in rapid fire. [REDACTED] said after he heard the gunshots he told his wife to take their daughter and leave for their safety. [REDACTED] said that he was outside working on his truck when he heard the gunshots.

I asked [REDACTED] if he saw police vehicles coming to [REDACTED] property. [REDACTED] said that he saw, Sheriff and Hoopa Tribal Police going to [REDACTED] property with their emergency lights on. I asked [REDACTED] if he knows a [REDACTED] and he told me, no.

I asked [REDACTED] if he heard anyone yelling from the [REDACTED] property when law enforcement was on scene. [REDACTED] said he heard someone, "hooping and hollowing". [REDACTED] went on to tell me through out the day when law enforcement was on scene he heard three separate volley's of gunshots. [REDACTED] told me at approximately 2000 hours he heard approximately 4 to 6 gunshots. [REDACTED] said he was outside of his residence and he heard officers state, we returned fire. [REDACTED] said he heard officers calling for a roll call after he heard the gunshots. [REDACTED] said he could hear an officer on the police loud speaker, telling the [REDACTED] to come outside. [REDACTED] said he could not remember the exact words that the officer on the loud speaker was saying.

I asked [REDACTED] if he was able to see what officers at [REDACTED] house were during this incident. [REDACTED] told me had he walked to the rear of his property he could see [REDACTED] house, but because of the gunshots being fired that would not be safe. [REDACTED] told me he eventually left his property Sunday night at about 2100 hours .

[REDACTED] told me that on Monday morning about 0900 hours he returned home. [REDACTED] said he remembers on Monday morning hearing some type of shooting occurring on [REDACTED] property. [REDACTED] described those sounds as more of thuds not gunshots. (I believe [REDACTED] was hearing chemical agents being fired from a 37mm into [REDACTED] residence).

[REDACTED] told me that on Monday he was at his house when he saw smoke coming from [REDACTED] property. [REDACTED] said he saw fire trucks on the road and heard fire personnel state, wait until it's safe, before you go in. [REDACTED] said he was unsure on what time this occurred. [REDACTED] told me that his wife, [REDACTED] was not currently at home, but he would call me on my cellular telephone when she returns home this morning. I then left his residence. A short time later I received a telephone call from [REDACTED] [REDACTED] who told me she was now at home.

I then ended my interview with [REDACTED] [REDACTED]

On 06-05-2007 at 0955 hours, I spoke to [REDACTED] [REDACTED] at her residence, regarding this investigation. I used a digital recorder to record our conversation. I later transferred the interview to a CD-R, which I booked into evidence. The following is a brief summary of what [REDACTED] relayed to me about this investigation.

[REDACTED] told me on Sunday, she was aware of a problem occurring at [REDACTED] property, because she received several telephone calls from friends, who were listening to police scanners. [REDACTED] told me that those friends told her that there might be some sort of hostage situation occurring at [REDACTED] house.

[REDACTED] told me when she looked outside she saw cops above her house at approximately 1530 hours on the driveway leading to [REDACTED] house. [REDACTED] told me at 1830 hours she heard gunshots coming from the [REDACTED] property. [REDACTED] said after she heard the shots she looked up the hill from her house and saw one or two cops ducking. [REDACTED] said she does not remember how many shots she heard, but it was more than one. [REDACTED] said after the shots were fired her husband, [REDACTED] told her and the kids to leave and go down the hill. I asked [REDACTED] if she knew [REDACTED] and she told me, no.

I then ended my interview with [REDACTED] [REDACTED]

On 06-05-2007 at 0900 hours, I contacted [REDACTED] [REDACTED] and her daughter, [REDACTED] [REDACTED] at their residence located at [REDACTED] Bloody Camp Road, Hoopa. The [REDACTED] residence is located approximately 1 to 2 miles up Bloody Camp Road from [REDACTED] [REDACTED] property. I used a digital recorder to record our conversations. I later transferred the interview to a CD-R, which I booked into evidence. The following is a brief summary of our conversations.

I asked both [REDACTED] and [REDACTED] if they knew [REDACTED] and when was the last time they saw or spoke to him. They both told me that they saw [REDACTED] on Sunday at 1300 hours, when they both drove down Bloody Camp Road in their vehicle to go to the store.

[REDACTED] and [REDACTED] when they returned from the store they saw, [REDACTED] walking up Bloody Camp Road. They told me that [REDACTED] was approximately half way up the hill near the deerskin gate off Bloody Camp Road. They both said that they recognized [REDACTED] and stopped to see if he needed a ride. They both told me that they have known [REDACTED] for years.

I asked them what [REDACTED] was wearing and they both told me a trench coat and a beanie hat. They both told me it was approximately 80 degrees on Sunday and [REDACTED] was sweating. I asked what [REDACTED] said when he got into their vehicle. [REDACTED] and [REDACTED] told me that [REDACTED] told them he was going to [REDACTED] and [REDACTED] house to visit. I asked them if [REDACTED] was carrying anything and they told me a thermos. I asked them if [REDACTED] was acting different than he normally does on Sunday. They both told me that he had a, weird look in

his eyes. I asked them what they meant by a weird look in his eyes. They told me that he looked like he had something on his mind and did not talk too much. They said [REDACTED] said he needed some sleep and water to drink.

I asked [REDACTED] and [REDACTED] if they gave [REDACTED] a ride in their vehicle. They told me that they gave [REDACTED] a ride and dropped in off in front of [REDACTED] and [REDACTED] driveway. I asked [REDACTED] and [REDACTED] if it was normal to see [REDACTED] on Bloody Camp Road. They both told me that they have never seen [REDACTED] walking on Bloody Camp Road in the past.

I then ended my interview with [REDACTED] and [REDACTED] [REDACTED]

On 06-05-2007 as I was leaving the Bald Hill area, I spoke to DA Investigator, Mike Hislop on the radio. Hislop requested that I contact Sergeant Mike Fridley for a statement of his involved in this incident and take custody of some cassette tapes that Sergeant Fridley used to record his conversation, when he was negotiating with [REDACTED]. I then responded to the Sheriff Office substation located in Hoopa at 1325 hours to speak with Sergeant Fridley.

I spoke Sergeant Mike Fridley and I recorded our conversation on a digital recorder. I later transferred my interview to a CD-R, which I booked into evidence. The following is a brief summary of what Sergeant Fridley relayed to me about this incident. Sergeant Fridley had already given a statement to Detective Quenell about this incident on Sunday night.

Sergeant Fridley told me that he is a hostage negotiator for the Humboldt County Sheriff's Office. Sergeant Fridley told me that he responded to [REDACTED] property located off Bloody Camp Road, Hoopa on Sunday, 06-03-2007. Sgt. Fridley told me that when he arrived on scene he used a Hoopa Tribal Police vehicle as cover. Sgt. Fridley said that Deputy Jason Daniels was also with him, because Deputy Daniels is also a hostage negotiator for the Humboldt County Sheriff's Office. Sergeant Fridley told me while on scene setting up negotiations with [REDACTED] he was positioned approximately 50 yards to the south east of the residence.

Sergeant Fridley told me that when he began to negotiate with [REDACTED] he used the loud speaker on the Hoopa Tribal Police vehicle. Sergeant [REDACTED] said that when he was speaking on the loud speaker he would turn on his cassette tape recorder to record his negotiation with [REDACTED]. Sergeant Fridley said that he used a total of 6 cassette tapes during the course of his negotiation with [REDACTED]. Sergeant Fridley said he booked those 6 cassette tapes into evidence at the Hoopa sub station. I asked Sergeant Fridley to give me those 6 cassette tapes, which he then provided to me. I later transported those 6 cassette tapes and placed them into our evidence locker in our main office in Eureka.

Sergeant Fridley said when he and Deputy Daniel were on scene they were kneeling down behind the driver's side of the Hoopa Tribal police vehicle using the engine block as cover. Sergeant Fridley said that there were two Hoopa Tribal police vehicles on scene

and Sheriff's Office Special Enforcement Team (S.E.T.) members were using the other vehicle as cover. Sergeant Fridley told me at approximately 2053 hours he heard someone yell that the [REDACTED] was opening one of the windows on the house. Sergeant Fridley said he then turned on his cassette recorder and he started talking to [REDACTED]. Sergeant Fridley said that he was using the loud speaker on the patrol vehicle.

Sergeant Fridley said when he started talking on the loud speaker he heard the sound of a bullet strike near his location. Sergeant Fridley said he heard the crack and snap of the bullet. Sergeant Fridley said the bullet went through the brush approximately 5 feet from his location. Sergeant Fridley said that he captured the sound of the bullet on his tape recorder. Sergeant Fridley said that recording was on cassette number one side B.

Sergeant Fridley said after he heard the shot he broadcasted on the radio, shots fired. Sergeant Fridley said S.E.T. members on scene returned fire. I listened to the cassette tape that Sergeant Fridley described to me. I could clearly hear the first shot that Sergeant Fridley described to me as the crack and snap of a bullet. I then heard on the tape cassette a second later 6 shots one after the other.

I then spoke to Sergeant Fridley on what had transpired on Monday, 06-04-2007. Sergeant Fridley said that after Sunday night he went home to get some sleep. Sergeant Fridley said he came back to work on Monday, 06-04-07 at 0800 hours. Sergeant Fridley said that he drove back to the location of this incident. Sergeant Fridley said he was on scene again to be the negotiator attempting to convince [REDACTED] to come out of his residence peacefully.

Sergeant Fridley said on Monday morning and he was unsure of the time, S.E.T members started to use chemical agents in an attempt to get [REDACTED] out of the residence. Sergeant Fridley said, because S.E.T members were wearing protective chemical masks they were unable to use the loud speaker to tell [REDACTED] to come out of his residence peacefully. Sergeant Fridley said that he was then broadcasting on the loud speaker from the Hoopa Tribal police vehicle to tell [REDACTED] to come outside and surrender peacefully to law enforcement. Sergeant Fridley said he made the announcement on the loud speaker every 10 to 15 minutes for several hours telling [REDACTED] to please surrender, before chemical agents were placed into the residence.

I asked Sergeant Fridley if he witnessed chemical agents being deployed into the residence. Sergeant Fridley said he witnessed two different types of chemical agents that were deployed into the residence. Sergeant Fridley said the first type was a ferret round that was shot from a short looking type shotgun. Sergeant Fridley said that they were being shot at side 4 of the residence, windows A and B, which was the south side. Sergeant Fridley said that ferret rounds were also fired at the south side by a 12-gauge shotgun.

I asked Sergeant Fridley which officers were firing the ferret rounds. Sergeant Fridley told me he witnessed Deputies Brian Taylor, Jamie Barney firing the ferret rounds. I asked Sergeant Fridley if he heard any movement from inside of the residence or any

yelling from inside of the residence during the time frame that the ferret rounds were being deployed. Sergeant Fridley told me that he did not hear any movement, nor did he hear any yelling coming from the residence.

I asked Sergeant Fridley if he witnessed deputies at some point approach the residence with a ballistic blanket on the south side of the residence. Sergeant Fridley told me that he saw Sergeant Brain Quenell, Deputies Brian Taylor, Jesse Taylor, Massaro, and Barney. Sergeant Fridley said because of the distance he could not tell, who threw hand held chemical agents into the residence. Sergeant Fridley told me that on the south side, which is also know as side 4. He saw what he believed was two hand held chemical agents thrown into windows A and B on side 4. Sergeant Fridley said after the hand held chemical agents were thrown inside, he saw white smoke coming out of the windows.

Sergeant Fridley said after the hand held chemical agents were thrown into the windows the S.E.T. members retreated from the residence using the ballistic blanket as cover. Sergeant Fridley said that after a while the white smoke stopped. Sergeant Fridley said 5 to 10 minutes after the white smoke stopped he saw black smoke coming from window B on side 4 of the residence, which is the south side.

Sergeant Fridley said that when he started seeing the black smoke coming from inside of the residence he started advising [REDACTED] over the loud speaker numerous times to come outside, because the house was on fire. Sergeant Fridley said he eventually saw flames inside of the residence. Sergeant Fridley said he could hear popping sounds, what he believed were rounds going off inside of the residence from the fire.

Sergeant Fridley said after approximately 45 minutes the Fire Department approached the residence with CDC SWAT team as protection.

I then ended my interview with Sergeant Fridley.

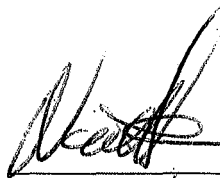
0330
9/9/07
Sergeant Wayne Hanson

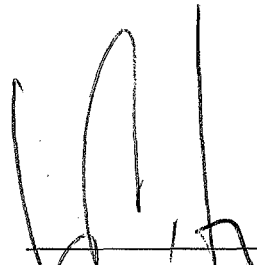
Supervisor 7/9/07

**HUMBOLDT COUNTY SHERIFF'S OFFICE
PROPERTY/EVIDENCE BOOKING AND RELEASE REPORT**

CASE NUMBER: 2007-3162

PAGE _____ OF _____

DATE STORED 6/21/07	TIME STORED 1300	DATE OF INCIDENT 6-4-07	CRIME 664/187 P.C.
NAME OF FINDER (ADDITIONAL VICTIM) STATE OF CAL.F	DOB	ADDRESS	PHONE
NAME OF FINDER (ADDITIONAL VICTIM)	DOB	ADDRESS	PHONE
LOCATION PROPERTY WAS FOUND (INCIDENT OCCURRED)			

ADULT ARREST
 JUVENILE ARREST
 SEARCH WARRANT NO.

TYPE OF PROPERTY

EVIDENCE FOUND SAFEKEEPING

DOB	DOB
DOB	DOB

PROPERTY CODES *178

S - Stolen	D - Damaged
R - Recovered	L - Lost
RA - Recovered (For Other Agency)	E - Evidence
F - Found	K - Safekeeping
	C - Contraband

PROPERTY/EVIDENCE LISTING

CODE	ITEM NO.	QTY.	DESCRIPTION	VALUE	NCIC	WEIGHT	DISPOSITION
E	101	60	CD-R'S OF STATEMENTS FROM: SOT MIKE FRIDUSY				

OWNERS OF PROPERTY

ITEMS NO.	NAME	DOB	ADDRESS	PHONE	NOTIFIED
ITEMS NO.	NAME	DOB	ADDRESS	PHONE	NOTIFIED
ITEMS NO.	NAME	DOB	ADDRESS	PHONE	NOTIFIED

LAB WORK REQUIRED

ITEMS NO.	PURPOSE OF EXAM
ITEMS NO.	PURPOSE OF EXAM
ITEMS NO.	PURPOSE OF EXAM

BOOKING OFFICER W. ANSON	PIN 0330	REPORT DATE	SUPERVISOR REVIEW	PIN	REPORT DATE
-----------------------------	-------------	-------------	-------------------	-----	-------------

CASUALTY COPY

HUMBOLDT COUNTY SHERIFF'S DEPARTMENT

CASE: 200703162
INTERVIEWER: Steve Quenell, Detective
SUBJECT:
STATEMENT OF: Sgt. Mike Fridley
DATE & TIME: June 3, 2007 @ 0244 hrs.
LOCATION: Hoopa, California

ALSO PRESENT:

SQ Steven Quenell
MF Mike Fridley

SQ Okay the time is zero two forty four (0244) hours. I'll be interviewing Sergeant Mike Fridley of the Hoopa Station. This is in reference to the [REDACTED] shooting case uh that occurred up on Bloody Camp Road. The current time is zero two forty four (0244) hours, the date is the fourth (4th) of June. My name is Detective Steve Quenell uh Sergeant Fridley in your uh own words could you uh,

UF Hi.

SQ Hi.

UF I'm just wondering what'd going on now with my son's, my other son's car was parked there when I left and I didn't see him coming down the hill. Did you guys ask him to leave and park down here?

SQ No, no, if anybody left, the left on their own accord.

UF Oh I'm just wondering.

SQ Yeah.

UF So what's going on right now?

SQ They're just still talking.

UF Oh well they weren't there when I left like a half hour ago.

SQ Who are we talking about?

UF These guys here.

SQ These guys are coming to relieve

UF The other ones?

SQ Yeah.

UF All right I'll go look for (inaudible).

SQ All right we were momentarily uh interrupted there so Sergeant Fridley in your own words could you explain to me uh what information you have relating to the shooting tonight?

MF Uh which one (1), there's been a couple different one's there?

SQ Well lets' just start at the beginning, how did you get dispatched up here?

MF Um I received a call at my house in regards to negotiator call out, and uh I had to make arrangements to get my son back over to Eureka, I did that and then I responded here, when I arrived the mother, I think the father of the [REDACTED] were here at the end of the road, gravel road and the and the pavement,

SQ Before we get to far, about what time was that that you got the call?

MF I think around four (4) something around there, three thirty (3:30) four (4), I'm not sure.

SQ Okay.

MF Um anyways, I don't know, I couldn't tell you when I got here it was after five (5).

SQ What kind of call was it?

MF Uh some deputies had gone to do a welfare check um when they arrived the, I don't know if they made contact with the [REDACTED] or he came outside but I was told that he pointed a gun at Deputy Berry and was now inside the house, and they were requesting uh negotiator call out, that's how it was given to me.

SQ Okay.

MF So anyways when I arrived uh I met with Lieutenant Cavinta and he pointed out the parents or the mother, I know it was the mother I'm not sure if it was the father of the [REDACTED] they were out here at the end of the road, I began to talk to her and get some uh um back ground information on [REDACTED] that may be helpful during negotiations as I was talking to her I heard several gun shots come from the area of the house that the [REDACTED] is in, um it sounded like one (1) or two (2), quieter, I guess smaller caliber gun shots and then three (3) or four (4) or maybe two (2) or three (3) larger caliber gun shots uh I jumped into my patrol car, Deputy Daniels got in the back and we drove down to the scene um there was several other patrol cars stacked up in the, in the road here, we got out and ran down to where we found a bunch of other officers taking cover behind two (2) of the Hoopa Tribal SUV's I was told that both of the SUV's had been shot at I could see that there was a bullet hole in the windshield or not a bullet hole, but an impact in the windshield of the second (2nd) SUV and I was told that that was from the [REDACTED] in the house. Um everybody kind of just kind of kept an eye on the house, there was no other, further shooting for quite some time. Um at one (1) point, I'm not sure we'd have to look on the tape, Deputy Daniels and I began negotiations, it's un tape recorded on a cassette tape.

SQ Mm hmm.

MF And I noted the times and all that that we began and all that. We, I talked to him over the P.A. system, I was never able to hear any responses from him but apparently some of the SET Team members that were closer could hear him yelling.

Sq And by him, who are you referring to?

MF [REDACTED] yelling form inside the house. Nobody was able to understand what he was, what he was saying um, I

SQ Did you ever see him?

MF No I did not. I remember hearing uh who, who type yelling coming from inside the house um,

SQ What's the closest that you, you got to the house?

MF We used the second SUV, the second Hoopa Tribal SUV as our command vehicle, we were using the P.A. in that vehicle, I never went further forward than that vehicle.

SQ Approximately how many yards would that be?

MF From the residence?

SQ Yeah.

MF Oh gosh, uh probably forty (40) fifty (50) yards somewhere in there.

SQ Okay. And when you heard the shots, where were you at in relationship to the house?

MF Um I was, the first volley of shots I heard, when I heard was, I'm not sure the name of this road right here is this the Bloody Camp?

SQ Bloody Camp road.

MF Okay. The end of the driveway that goes in to the residence and Bloody Camp intersection that's where I was at when I heard the first (1st) shots.

SQ And how many shots did you hear?

MF I would guess probably four (4) or five (5) somewhere in that area, maybe three (3), between three (3) and five (5), I'm not, I didn't count them so I'm not sure, it happened so quickly.

SQ Did, did they all sound the same?

MF No it sounded like the first or second, first, at least one or two of the shots, like I said quieter like a smaller caliber rifle and then after that it was one or two that sounded like a larger caliber. To me it sounded like two (2) different weapons, you know a quieter one (1) and then a louder one (1) after that.

SQ Okay. And uh what was your, your purpose for coming up here uh to the scene?

MF I'm a trained negotiator and I was, I'm on the hostage negotiating team for the Sheriff's Department and my job was to come up uh and pair up with Deputy Daniels and do the negotiating.

SQ Who was the supervisor here where you got here?

MF Um Lieutenant Cavinta.

UM I've got to break in real fast. Uh apparently they didn't get the word that they were going to be down close so they don't have helmets and the shit they thought they were going to be set up somewhere else, so I'm probably going to pass my helmet on, I don't know if you're interested in doing that or not, but they have nothing and they're gonna be up there.

MF Okay.

SQ So you heard a total of how many shots?

MF Between three (3) and five (5).

SQ Three (3) and five (5) and just one (1) volley?

MF Yeah just one (1) quick yeah.

SQ Did you hear any other shots at any other time?

MF Yes.

SQ And what was the time difference between when you heard the first volley and then the second (2)?

MF I couldn't tell you it was, if I had to guess between an hour and two (2) hours.

SQ Okay.

MF We had moved down Deputy Daniels and I had set up our negotiating in the vehicle, I had negotiated or talked on the P.A. for a while, Deputy Daniel had talked on the P.A. for awhile and I'd gotten back on, I can't remember how many times we did a, a change but at one (1) point where I was talking, I heard a shot, it sounded like it hit something and then ricochet and I heard it hit the brush, well I, within ten (10) feet of me.

SQ Was it still daylight?

MF That I don't remember, I, I think it was yes?

SQ Was anyone next to you when, when this happened.

MF Yes Deputy Daniels was right behind me.

SQ Okay.

MF Acting as my couch.

SQ And then when you heard that shot what happened?

MF Several of the SET Team members returned fire.

SQ Do you recall how many shots the SET Team had fired?

MF No I don't, I couldn't even guess, uh more than one (1)?

MF Yes. Between one (1) and five (5) maybe more.

SQ Okay. Do you have any idea who shot those rounds?

MF I was told later but I didn't know,

SQ Uh huh.

MF No I didn't see them shot.

SQ Okay. Who were you told later that shot?

MF Um Deputy Gomes, Sergeant Quenell, and I'm drawing a blank on the last person, I can't remember the last name.

SQ Okay. Up until the time that uh you came to the command post, and we made arrangements for you to give the statement, where have you been located?

MF At the second (2nd) SUV that we were negotiating from.

SQ Okay so you've been there basically all night until now?

MF pretty much, I've had to come to the command post a couple times just for information but this is where I've been since then.

SQ Okay is there anything else that we haven't discussed or anything that comes to your mind that uh, that uh might assist us in this investigation?

MF Yeah I wrote something down that he said, it was at un nineteen forty four (1944), I didn't hear it but some of the people in front on me said they clearly heard him say this, and I wrote it down just because I wanted to keep, make note of it, it said "mother fucker come and get some" and a couple different people heard that.

SQ And about what time was that?

MF That was at nineteen forty four (1944).

SQ So, correct me if I'm wrong, you heard that or somebody else heard that and they told you?

MF Somebody else heard it and told me.

SQ So one (1) of the other,

MF I think it was one (1) of the SET guys that was closer than I was.

SQ Okay.

MF But they weren't in a position to write anything down and

SQ Okay.

MF I wanted to keep track of that.

SQ Okay. Is there anything else that we haven't discussed that you think that we uh, we need to talk about?

MF Not that I can think of.

SQ The ending time will be zero two fifty six (0256) hours.

End of Statement.

Transcribed on 8/28/07 by [REDACTED] 0608.

HUMBOLDT COUNTY SHERIFF'S DEPARTMENT

CASE: 200703162
INTERVIEWER: Steve Quenell, Detective
SUBJECT:
STATEMENT OF: [REDACTED]
DATE & TIME: June 4, 2007 @ 12:19 AM.
LOCATION: Hoopa, California

ALSO PRESENT:

[REDACTED]
SQ Steven Quenell

SQ Okay the following will be a statement, uh with myself I'm Detective Quenell and I'll be talking to [REDACTED] her date of birth is [REDACTED] her address is [REDACTED]. Her cell phone number is [REDACTED] [REDACTED] uh [REDACTED] is unemployed, she is a housewife uh currently the date is the fourth (4th) of June, it's about nineteen (19) minutes after twelve (12) midnight, uh this conversation I'm having with [REDACTED] is in reference to um [REDACTED] and uh the shooting incident involving the uh local uh Tribal Police and Sheriff's Deputies, so [REDACTED] in your own words if you could explain to me um you know what happened or?

[REDACTED] Uh well we was just at home at the time and I was cleaning my dishes and stuff up and we heard a door knock and at first I thought my kids were playing around out there but my son came and answered the door and I heard somebody say is your dad home and he goes yeah my dads home but he got a spider bite and he can't move and he goes, can I come in and get a drink of water and when he came into my house, I didn't really you know say he can come into my house and I didn't recognize him at first either who he was cause of the facial hair and the long hair and it kind of startled me for a minute but my son comes up to me and say's mom it's [REDACTED] [REDACTED] and I didn't know what to think you know and he had this long trench coat on and stuff and I had a feeling right off the bat that there was something wrong and that he looked at us and he goes, I need help, you know and I go well where's your mom and he goes I don't want to speak to my mom he says, I just need help, that's all he kept saying to us and that's when I got scared and I came over to the neighbors house, I act like I had to go get a cake pan, just to get my kid out of the house and I called his mother and I told them that he was up here and I stayed over here for a while and waited for her to call me back and she called me back and said where are

you and I said I'm at the neighbors house I said you got to come and by that time she said she called the ambulance and she called the Tribal Police to have, have them come up here and meet me at the end of the driveway, and I can't remember what time it was, I wasn't keeping track of the time because I was just to stressed out.

SQ Was it still daylight?

■ Yeah it was still daylight and um I didn't know what to think and I was worried and I had a feeling that you know my husband worked for the ambulance he drove the ambulance for five (5) years and he could read people and he knew that there was something wrong with ■ and he needed help and we never seen him for like two (2) three (3) years, and I didn't know that he was very ill and he needed help you know and we didn't know what to think and I just kept calling his mom and telling her that you have to come up, you have to come up here and do something because we were suppose to been to a birthday party and it just fouled everything up all day and I didn't think that you know things were going to turn out like this and I didn't want this kind of stuff to happen here but I didn't know what to do I really didn't officer.

SQ How long, how long have you known ■

■ I've known ■ since he was five (5) years old.

SQ Uh huh. Do you recall what ■ was wearing tonight when he came in?

■ Um yeah when he came in he had these big boots on, black boots on and um he's wearing uh, different color gloves, a blue glove, a rubber glove on one side and a white glove on the other side and a long trench coat and um some kind of a beanie hat that covered his face kind of and he was really sweaty like he was walking for miles and what I understand that it was my neighbors up here uh the ■ that gave him a ride up here and dropped him off here at the end of the driveway.

SQ Okay.

■ And then I mean I, this is the first, I mean I just now got a hold of my husband because he was um you know out there and with the officers, the officers didn't want him to leave the premises and I don't know what was going on, I mean I'm still like in shock, I don't know

SQ Okay.

■ I don't know what's going to happen or what's going on I mean my kid's like so traumatized now I don't know what to do,

SQ Right.

■ But uh these had to leave down here and they didn't want me to stay in there yard, they were all freaked out so they all split and I didn't know where went so,

SQ Okay. Well ■ if you had to explain to somebody uh where you live up here what do you regard your place as?

■ The way, way we describe our place where we live, we go you mean the description?

SQ Yeah, yeah

■ I mean I always tell everybody to go to the white cross up here to the turn out, come back down and it's the first drive way to the right.

SQ Okay and what road do you live on?

■ I live on Bloody Camp road, it's, it's the usual name of the Bloody Camp Road, but it's Bald Hill road.

SQ Okay. And can you describe your house for me?

■ Um yeah kind of, I mean once you go take a left to, I mean go through these two white post, go through the gate and it's the green trailer with like a yellow painting, kind of looks like green bay packers colors.

SQ Okay, um are there any weapons in your house?

■ Um there's yeah there's a couple in there.

SQ Can you describe them?

■ I don't know what kind of weapons, I don't the,

SQ Are they rifles or pistols?

■ There's a pistol and a rifle.

SQ Okay, all right.

■ I don't under, I don't, I don't know rifles, guns or whatever you know but big one (1) small one (a).

SQ Right. Did you hear any gunshots tonight, at any time?

■ Um when I was up at my aunts' house up above us, yeah we did.

SQ How many shots did you hear?

■ It startled me, a couple shots uh like two (2) shots and then a couple fired back, that's all I heard from up there on the patio, cause I tried to come down here earlier and they said no you are to leave the premises, you're not to come back here.

SQ Mm hmm.

■ And that's what that, I can't remember which one (1) it was but, I wasn't going to stick around anyway because I had my son and he wanted to go home to his dad and I couldn't let him go back there.

SQ Did you talk to uh, and you refer to him as ■

■ Yeah.

SQ Did you, when you were talking to him, did he seem normal or?

■ Oh no he wasn't normal, he was uh very delusional, he wasn't talking right, he was calling me his mom um the, he was, I don't know he was just, he was ask, he was looking out, you know calling out for help, he needed help.

SQ Okay. Okay.

■ That's all he kept saying I need help, I love you guys, I need help.

SQ (Inaudible).

■ And I tried to feed him you know I made him eat, I tried to get him to take a cold shower and cool down a little bit and he would not get undressed, he wouldn't take his clothes off, you know cause he was really hot and sweaty and I was worried that he was gonna fall out or something.

SQ Do you know if he's under the influence of anything, alcohol or drugs?

■ Uh he, he's not being normal, I don't know if he might be on drugs or something.

SQ Okay.

■ I've never known ■ to be on drugs or nothing but after I heard that he was really sick, then that made me worry.

SQ Mm hmm.

■ To where I was kind of scared for us ourselves.

SQ Mm hmm.

■ Like now you know.

SQ Sure, sure. So normally you know when this type of situation isn't going on, how many people live, live at your residence?

■ Just me my husband and my son.

SQ Okay and how old is your son?

■ We've had a lot of, my son's nine (9). We've had a lot of things happen up Bald Hill before you know and murders that was never solved, my cousins and stuff like that and it just brings back a lot of flashbacks and it like freaks me out.

SQ Okay, that's understandable.

■ Cause I have anxieties and it's like what I'm having now cause I don't have my medicine. It's all at my house.

SQ Okay.

■ I haven't had it all day and it's like.

SQ starting to get to you?

■ Yeah.

SQ Well ■

■ I'm sorry.

SQ That's okay, don't worry about it. Is there anything else that you could think of that we haven't talked about uh,

■ No I just.

SQ Regarding this situation.

■ I just wish uh, they would have never like uh come to my house like this or whatever, they know that it's a safe place up here and nobody bothers us you know but, I didn't think like he'd come to my house and do this.

SQ Right, right.

■ Cause I knew when I first saw him I knew, I knew he wasn't ■

SQ Sure, sure. Well listen if you can't think of anything else that will end this statement and it's twelve twenty seven (1227) hours.

End of Statement

Transcribed on 8/28/07 by ■ 0608.

HUMBOLDT COUNTY SHERIFF'S DEPARTMENT

CASE: 200703162

INTERVIEWER: Steve Quenell, Detective

SUBJECT:

STATEMENT OF: Thorn James McCovey, Officer in Charge

DATE & TIME: June 4, 2007 @ 12:53 AM.

LOCATION: Bloody Camp Road, Hoopa, California

ALSO PRESENT:

TM Thorn McCovey
SQ Steven Quenell

SQ Okay the following will be a taped statement uh the time is twelve fifty three (12:53) A.M. the date is the fourth (4th) of June. This will be in regards to the uh shooting incident that uh Humboldt County Sheriff's Office, Tribal P.D. both Yurok and Hoopa and the interview that I am conducting, I'm Detective Steve Quenell, I'll be talking to Thorn McCovey, M-c-C-O-V-E-Y, middle of James uh Thorn works for the Yurok Tribal Police his current rank in Officer in Charge and uh the conversation we're having is um, what do they call this road?

TM Bloody Camp road.

SQ Bloody Camp road, it's actually the entrance to the residence, uh where the shooting uh occurred. Thorn in your own words uh can you uh explain to me what you know about uh what happened tonight?

TM Okay we um copied radio traffic that uh Q40 (forty) and twenty four zero two (2402) which is Deputy Berry and Officer Landreneaux um needed back up uh they uh they radioed that the [REDACTED] had knives and brandished them so uh we expedited from Bald Hills road near Martins Ferry. Uh we arrived here somewhere between um I'd say probably three forty (3:40) and three fifty (3:50) or so, somewhere in there and uh we, we were uh positioned by the uh officer in charge at the time uh Chief Hostler, here with Hoopa P.D. to um take a position of advantage on the hill above the residence on the east, uh east end, actually north east side is where we were positioned, the for the perimeter, there we stood by uh and just kept eyes on the uh residence uh from a position of covering concealment uh from where, from where I was I

couldn't see, couldn't see the [REDACTED] ever. I saw some movement in some windows but that was it um on the first, the first uh shooting started I couldn't see any of that um.

SQ How many shoots did you hear?

TM Let's see I heard, I heard the one (1) shot, then sounded like maybe four (4) or five (5) in return, but I, it's not for sure.

SQ And where were you at in relationship to the house when you heard those shots?

TM Um our position of advantage I'd say was more between uh three (3) to four (4) hundred feet up the hill, the uh north east side of the house um and the, the door that the guy come out several times is on the west side of the house to my understanding.

SQ Okay so you never had a visual on, on the guy?

TM No I didn't.

SQ And again what side of the house were you guys observing?

TM The east side.

SQ East side okay.

TM The back door was on the east side of the house so that was our main uh, um responsibility.

SQ And you said you heard some shoots?

TM Yeah the, yeah it sounded like uh one (1) shot to begin and then uh return fire probably four (4) or five (5) shots.

SQ Okay and then what happened after you heard the shots?

TM Um some radio traffic you know they uh radioed in to Dispatch, shots fired, uh it took them a while to come back and say yeah they fired at us, they fired at the, the deputies and uh so we all, we all stood by I guess and kept eyes out for any other activity.

SQ About what time was that?

TM I'm thinking somewhere, somewhere just after four (4) o'clock,

SQ Okay.

TM I'm not exactly sure but I, I think it's somewhere around there.

SQ So you guys maintained your position?

TM Yeah we just, we maintained our position, kept, kept eyes on the back, back door and the back windows.

SQ Did anything happen after that?

TM Uh no not for a long time um yeah we, we watched the residence for hours and I think it was somewhere before nine (9) o'clock that there was um, somebody radioed over, over the airways, windows open, windows open and then a few seconds after he said that I heard some more shots and uh that time we heard the uh, the rounds whistling you know past us as they were firing over in our direction and uh we heard one (1) round like that and then we heard, oh geez it must have been between ten (10) fifteen shots returned fire at that point, that was, that was shortly before nine (9) o'clock.

SQ Okay so you heard one (1) shot, and then you heard after the one (1) shot, ten (10) to fifteen (15) shots?

TM Yeah I can't be positive but that's what it sounded like to me.

SQ And about what time?

TM Somewhere maybe uh, maybe ten (10) minutes before nine (9) o'clock.

SQ Was it dark?

TM Not quite.

SQ Okay and who was next to you when that was going on?

TM There was Officer McKillip to my left and Officer Roberts of Hoopa P.D. to my right.

SQ How far away from you?

TM they were each about fifty (50) feet away from me.

SQ Did you have a visual from them?

TM Yeah a visual on both of them.

SQ Did any of you three (3) uh shoot your weapons?

TM No.

SQ Okay. Um did you ever fine out who shot their weapons?

TM No. I um, yeah I didn't know for sure who shot their weapons.

SQ Did you ever hear or did you, a statement I had, uh I got earlier, somebody had referred to some of the tribal vehicles had been hit by gun fire?

TM Yeah that, I heard that after the fact, after they'd pulled us down of the hill.

SQ Okay.

TM At about it must have been about ten thirty (10:30) that they, they finally pulled us off the perimeter and uh a couple of the Hoopa officers were talking about the Hoopa rigs got shot up.

SQ Okay so approximately what time was uh was it when you first responded up there and secured you know the side of the building that, that you, you stayed at?

TM I, you know somewhere I don't know because I didn't look at the clock, but I think it was somewhere around uh three forty five (3:45).

SQ And then you remain there until what time?

TM Till,

SQ Approximately.

TM About ten thirty (10:30) that night twenty two thirty (2230).

SQ Did someone relieve you?

TM Yeah the um the command radioed to us to uh come on down the hill, they relieved us of our position so,

SQ Did you see anyone else up there in uniform?

TM I couldn't see them they um, my partner uh Kevin McKillip and uh Mike Roberts both said they could see the uh the SWAT guys and in position, but I, I could never see them.

SQ Mm hmm. Do you know this individual that uh that they're dealing with here?

TM No never heard of him.

SQ Never heard of him. Is there anything else um that uh we haven't talked about that, that might help shed uh some light on, on what took place?

TM No and we're, our involvement was uh for the most part back up.

SQ Mm hmm.

TM And uh we were used for what uh the command needed us for and that's pretty much it.

SQ Okay. That will end our tape statement. The time is um zero one zero two (0102) hours.

End of statement.

Transcribed on 8/23/07 by [REDACTED] 0608.

HUMBOLDT COUNTY SHERIFF'S DEPARTMENT

CASE: 200703162
INTERVIEWER: Steve Quenell, Detective
SUBJECT:
STATEMENT OF: [REDACTED]
DATE & TIME: June 7th, 2007 @ 11:13 hours.
LOCATION: C.I.D. Eureka, California
ALSO PRESENT: Mike Hislop, District Attorney Investigator

[REDACTED]
SQ Steve Quenell
MH Mike Hislop

SQ Okay the following will be a taped statement regarding case number two zero, zero seven, zero three one six two (200703162), the interview will be conducted in my office, I am Detective Steve Quenell Humboldt County Sheriff's Office also present is Chief Investigator with the Humboldt County District Attorney's Office, Mike Hislop uh we will be interviewing [REDACTED] today's date is the seventh (7th) of June two thousand and seven (2007), the time is eleven thirteen (1113) hours. Uh I'll refer to [REDACTED] during this interview as [REDACTED] currently is a dispatcher with the Humboldt County Sheriff's Office. [REDACTED] how long have you been working for the Humboldt County Sheriff's Office?

[REDACTED] Four (4) years in July.

SQ And what's your position uh other than Dispatcher?

[REDACTED] Senior Dispatcher, Tactical Dispatcher, Hostage Negotiator.

SQ Okay. What type of specialized training have you received in that area?

[REDACTED] I went to a weeklong Post Accredited Tactical Dispatch school, as well as a weeklong Hostage Negotiation POST school.

SQ Okay. Sometime during uh this incident that uh obviously the case number two zero, zero seven, zero three one six two uh is involved or was involved in up on Bloody Camp Road, somehow you got involved in this incident?

■ Yes.

SQ In your own words what I'd like for you to do is to explain how you got involved and just basically um what you know about what took place up there.

■ Approximately sixteen twenty (1620) hours on Sunday afternoon June third (3rd) I was phoned at Detective Schlesigers residence regarding a call out for a tactical dispatcher regarding a barricaded ■ in the Hoopa area who was armed. At that time I got ready and shortly after Detective Schlesiger phoned Lieutenant Cavinta who asked him to also respond at that time we responded together approximately sixteen forty (1640) hours we left Fortuna from Detective Schlesigers residence, stopped by the office retrieved necessary paper work materials to complete the duties of a tactical dispatcher, traveled to the scene, approximately sixteen twenty (1620) hours we arrived on scene, within five (5) minutes of that we were standing outside of Detective Schlesigers vehicle, observed Lieutenant Cavinta speaking with what I learned later were family members of the involved ■ and just shortly after we arrived on scene heard shots being fired, I don't recall how many were or what type I just remember hearing shots. Retreated back to Detective Schlesigers vehicle waited uh a period of time approximately twenty (20) minutes after that I was escorted by Lieutenant Knight's to Lieutenant Cavinta's location, which was on the gravel road leading to the ■ residence, um at that location, I briefed with Lieutenant, there were Tribal Police Officers on scene, they briefed us, gave us a little bit more information um at that time there was no Command Van on scene I was just trying to get the information related to the call from the Tribal Officers that were on scene prior to our arrival um and I should have noted when we arrived on scene there was still patrol, patrol cars pulling in after we had arrived and they were um driving Code three (3) and then pulled on to the gravel road as well and all hopped out of their vehicles when the shots were going off, and so we were briefing with the Tribal Officers, I don't know how long we were there approximately twenty one hundred (2100) hours I heard additional shots being fired, I was standing outside of a patrol vehicle with Detective Schlesiger, twenty five A one (25A1) Willie Hostler, Eddie Guyer, Matt Spallino and I believe the CHP Officer was behind us when the shots went off. Um we all ducked down on the ground and I was provided cover shortly after that Detective Schlesiger escorted me back up the gravel road to a safe place um at that point the Command van was on scene um and after a time after the shots were fired patrol vehicles that were all lines up on the gravel were rearranged after that took place approximately twenty one thirty (2130) or twenty one forty five (2145) hours the Command van was in place at the entrance to the gravel road, at that time I assumed the position in the Command van and from that point um basically scribed information that was coming from the Sheriff's Office S.E.T. Team as well as Lieutenant Cavinta requests that were incoming and outgoing, um at some point in the evening Lieutenant Cavinta made a request for E.P.D.'s S.W.A.T. Team to relieve team, I documented that um at various times during the night I heard Sergeant Fridley trying to make communications with the ■ with no luck, those are documented I heard them over the P.A. but nothing in return um

SQ (Inaudible).

■ So at that point between the time of the second (2nd) shots being fired and the time that E.P.D. arrived; I was basically a scribe for Lieutenant Cavinta and the S.E.T. Team. um E.P.D. arrived on scene at approximately zero two forty five (0245) hours, I briefed their Tactical Dispatcher ■ um we were in the Command van together until our team was relieved approximately zero four hundred (0400) I left the Command van and at that time I left, I think it was at like zero four fifteen (0415) with Detective Quenell and Detective Schlesiger, we retreated to Willow Creek, returned at approximately zero six forty five (0645) hours, at that time I retreated back to the Command van, met with E.P.D. Dispatcher, she briefed me on the evenings events when we were gone, I guess it would have been morning events, that time around zero seven hundred (0700) hours, her team was relieved they took a break, she left the command van, I again assumed the role of a Tactical Dispatcher, scribing the transactions between the Command van and the S.E.T. Team members as well as Lieutenant Cavinta, also in the Command van was a hostage negotiator from C.D.C. who was scribing for his team, um and at approximately eleven hundred (1100) hours, our team started putting in gas, again my duty at that time was just transcribing their radio transmissions. Pretty much things stayed the same till approximately fourteen forty five (1445) was when we first started getting information there was smoke coming from inside the residence. I don't recall the exact time that we were notified that there was a fire. Correction it was fourteen twenty (1420) hours that we were advised that smoke was coming out of the residence. At fourteen thirty six (1436) hours, Eureka P.D. L twenty four (L24) advised there was fire on the interior, again at that time we were just scribing the communications that were made during that. Approximately fifteen forty five (1545) hours fire was arriving on scene, (inaudible) structure fire um after they were done and the scene was clear, our members started coming back after they were released from their duty and from that point until the time that we left, I was basically in charge of peoples clearing times and again any additional requests made from Lieutenant Cavinta and documenting any further radio transmissions and I believe I cleared the scene around eighteen fifteen (1815) hours.

SQ Okay uh at any time after the incident occurred uh the residence caught on fire they put the fire out uh did you ever re, did you ever go down to that area?

■ I did.

SQ Okay.

■ Do you want me to elaborate?

SQ Yes.

■ Um after fire personnel was on scene the, the scene was secured and clear, Sergeant Buihner transported me down there. I was going to look for Lieutenant Cavinta to see what he wanted me to do at that time. He was busy speaking with Investigators, D.A. personnel; I didn't

get a chance to talk to him. I met with some of our S.E.T. Team members and was down there a short period of time and then returned back to the Command, Command van.

SQ And that was until you went uh off duty or left the area?

■ Mm hmm.

SQ Okay. Evidently uh you had uh mentioned to us at the beginning of this interview that you had received some type of specialized training for uh being a Tactical Dispatcher?

■ Correct.

SQ Where did you receive that training at?

■ Um it was in Riverside and I'm trying to think when I went, I think it was January of two thousand and six (2006).

SQ And who taught the class?

■ Tammy smith and she's her own um independent, uh what do you call, she's like an independent instructor.

SQ Okay.

■ She works for the Palo Alto S.W.A.T. Team. She's their S.W.A.T. Team Leader for Tactical Dispatch and then I've also been to Tactical Dispatch update course, taught by Dana Devers at College of the Redwoods and that was actually before I went to the forty (40) hour basic course.

SQ How long ago were those courses?

■ The first course was like I stated June or January of two thousand and six (2006) and I'm not positive on the dates of the update course that was taken before the forty (40) hour course.

SQ You (inaudible).

■ The update course was taken before the basic course.

SQ Okay. Can you explain to me uh what the definition of a Tactical Dispatcher is, what their, what their duties are?

■ Basically your duties are to scribe and transcribe any radio transmissions between the S.E.T. Team members and the communications as well as assisting the Incident Commander and documentation, phone request and that sort of thing.

SQ Okay, and during this incident, who was your supervisor?

█ Lieutenant Cavinta.

SQ You had mentioned that shortly after you arrived you heard shots?

█ Correct.

SQ Do you recall how many?

█ I don't

SQ And then it was after that that there were more shots?

█ correct.

SQ Do you have any idea how close those shots came to you or?

█ They sounded close to me but I'm not, I mean I have no idea.

SQ Okay.

█ How close they actually were.

SQ Okay the second (2nd) time do you recall how many shots?

█ I do not.

SQ More than one (1)?

█ More than one (1).

SQ At any time did you ever hear what the negotiator was saying?

█ Um I'm not familiar with surrender orders basically I mean he was, I didn't, trying to establish dialogue with the █ he wasn't acknowledging Fridley, I think a few times um he yelled some things that were un, I couldn't understand what he was saying where I was located, um I heard Fridley just calling him by name, telling him he needed to come out, we didn't want anybody to get hurt, that sort of thing. Basically the same thing over and over again, we don't want anybody to get hurt, come out, you need to come out, lets talk about this um, the communicate, I don't, they were short periods of time when he was trying to communicate with him and establish contact, they weren't long periods and I think he, basically did the same thing over and over again. I remember after um after the structure actually caught fire, he was you

know encouraging him over and over to come out, there's a fire, we need to get you out, we don't want you to get hurt, that sort of thing.

SQ Mm hmm. And how did you find out that the gas was going to be utilized?

■ The S.E.T. Team members advised us when the gas was going in.

SQ Who made the decision to utilize gas?

■ I believe Lieutenant Cavinta and the S.E.T. Team, Team Leader established that.

SQ Do you know who the S.E.T. Team Leader was?

■ Bryan Quenell.

SQ Okay. We're there any other Team Leaders that you're aware of that uh,

■ Sergeant Garcia, Sergeant Miller was assistant Team Leader.

SQ Okay. Mike do you have any questions?

MH ■ are you familiar with firearms at all?

■ No, not too much.

MH You've never shot any. When the shots went off, did it sound like they were loud shots or?

■ No it wasn't loud at, I mean at first it didn't sound like, it didn't sound like a gunshot at all and then I didn't really even know until the people who I was with who are familiar said that shots were being fired. I want to say that the second (2nd) round of shots were quieter than the first round.

MH Okay.

■ It was like a more dense sounding.

MH How many tactical incidents have you been on, assisted on?

■ This is only my second (2nd) one (1).

MH What was the other one (1)?

■ The Agency Assist at Super eight (8) for Eureka Police Department.

MH Through your training through your school and through the uh other tactical situations you're been in, did it seem like uh this was handled with normal protocol?

█ Yes.

MH All the steps were handled properly?

█ Yes.

MH Okay. Alright.

SQ █ uh before we end uh the tape is there anything that we haven't discussed uh or anything you have knowledge of that may help shed more light on this incident?

█ No I just would like emphasis hearing um Sergeant Fridley attempt on numerous occasions to establish dialogue with the █ and he was not um, not acknowledging Sergeant Fridley at all.

MH Was that about the same time that the shots rang out too?

█ They well I mean it was through out the night, I think I first heard them shortly after um the first (1st) round of shots when out. He started establish, trying to establish contact with the █ between the first set and the second (2) set.

MH Do you know if Sergeant Fridley tried to prior to the first (1st) volley of shots that you heard?

█ I wasn't on, I had just arrived see, I mean I arrived on scene maybe two (2) minutes before those first round of shot, I don't know if he, where his location was before that.

MH Okay.

█ I wasn't there.

SQ Okay. I don't have any other questions. That ends our taped interview and it is eleven thirty four (1134) hours.

End of Transcript.

Transcribed on 9/13/07 by █ 0608.

HUMBOLDT COUNTY SHERIFF'S DEPARTMENT

CASE: 200703162

INTERVIEWER: Steve Quenell, Detective

SUBJECT:

STATEMENT OF: Sergeant Randy Garcia

DATE & TIME: June 7, 2007 @ 11:45 hours.

LOCATION: C.I.D. Eureka, California

ALSO PRESENT: Mike Hislop, D.A. Chief Investigator

SQ Steve Quenell
RG Randy Garcia
MH Mike Hislop

SQ Okay the date is the seventh (7th) of June, two thousand and seven (2007). The time is eleven forty five (1145) hours. This will be a interview that's being conducted inside of my office, I'm Detective Steve Quenell with the Humboldt County Sheriff's Office, also present is Mike Hislop, with the uh Humboldt County District Attorney's Office he's also part of the uh Critical Incident Response Team, we'll be interviewing Sergeant uh Randy Garcia, uh Randy what's your date of birth?

RG [REDACTED]

SQ Okay and Randy what we're going to do today is discuss the incident that occurred on the third (3rd) and the fourth (4th) of this month up off of Bloody Camp Road uh evidently at some point uh you, you were involved or you were contacted and um if you could just explain um you're involvement and basically what happened.

RG Uh I received notification um a little bit after five (5) o'clock on Sunday the third (3rd) uh I was busy and didn't have my pager or cell phone, with me at that time, got it uh responded, while enroute uh it was at about Blue Lake on Highway two ninety nine (299) and I heard that uh shots had been fired I expedited to code three (3), arrived on scene uh I believe it's about eighteen fifteen (1815) hours, something about time on Sunday the third (3rd). Contacted Lieutenant Cavinta and Sergeant Quenell and was tasked with uh moving a team to the opposite side of the residence uh where the Yurok Tribal vehicles was parked um moved, moved my team down we had to take a circuitous route to get there, dropped down off the lower hill, down along

the creek cut through some uh fences, wire fences to, so that we wouldn't be in the line of fire. Took us about forty-five (45) minutes to an hour to get there uh came back, located the uh Yurok Tribal vehicle uh we came out above it and moved down. Um contacted uh a Yurok Tribal Officer Landreneaux and uh Deputy Berry um kind of had a brief conversation with them about what was going on and about almost nine (9) o'clock that night uh as Berry and Landreneaux were getting ready to leave uh heard one (1) large shot and then several smaller shots uh being fired again from the area opposite on the other side of the building where we were um I couldn't tell how many shots were fired because we were getting a echo from the valley, it was coming back, um I know I heard at least one (1) large, sounded like a larger caliber and then several smaller ones um stayed there for a while and then Berry and Landreneaux left, we stayed in that position monitoring until the sun went down, we moved closer with the Yurok vehicle um cause our night vision goggles wouldn't allow us to see clearly uh left, I left that scene at about two (2) something, I'm not sure what time, to go back to the command post, leaving my uh, my team there, uh met with Lieutenant Cavinta and Sergeant Quenell again and then E.P.D. Officer were on scene and I was asked to take them back to that location so they could sit on them while we uh had a break. I took uh Officer Cooper, Gary Cooper and uh Harpham out there along, pretty much the same path, we didn't have to go down as far cause it was, it was darker now. They took over, my team was relieved, came back and sat at the C.P. for awhile and uh kind of discussed what was going on, when all of our team members were back, we went to the uh Hoopa Substation, Sergeant Quenell and I uh sat down and worked out an O.P.'s plan um got back at about eight (8) o'clock to the C.P. and about nine (9) o'clock my team was back uh we started heading back toward our location, um got back to our location, when the sun had come up the E.P.D. Officers had moved the uh Yurok vehicle back uh further maybe uh a hundred and fifty (150) feet back to almost it's original location, pretty much the same area . Uh we took over from them. I deployed Deputy Bishop as a uh sniper in the open field above us so he had a clear visual of the uh front door and the number two (2) window, uh sat there uh I had four (4) people with me on scene there and then Deputy Bishop who was above us uh who we rotated in and out every few minutes, ten (10) fifteen (15) minutes or so um so to avoid fatigue, two (2) people watching two (2) people back and did that constantly and I think it was around eleven (11) something uh the discussion was made on the other side to start introducing uh gas, during this time we could hear the uh, prior to that we could hear the C.D.C. negotiators with the loud speaker from the car and then the portable loud speaker um trying to get the [REDACTED] to come out, he wouldn't, there was no response from in side um at the time when the gas was introduced I believe that was Sergeant Quenell's team was doing that, they uh, there was no response this went on for several hours, two (2) to three (3) hours I believe at least and then uh eventually there was uh, I'm not sure what time somebody on the other side said that they saw smoke coming from a window uh at little bit after that we could see a small trail of black smoke coming up from the far side of the house, uh I kept a visual on the front door and the number and there was a window on the number one (1) side as well, and a window on the number two (2) side I could see that. Deputy Bishop relayed that he could see the [REDACTED] on the ground in the number two (2) window covered up with some sort of blanket and he was crawling uh that was during the gas operations. The uh, eventually the fire got to point where, well the smoke got to the point where they could actually see flames and they were notified uh sometime after that we could see flames coming through the uh the far number one (1) side, which was also the number four (4)

windows, I could see flames in there. Smoke was getting heavier and started moving back towards the trailer, or towards the uh side of the trailer that I was on uh but there was no smoke coming out of the number one (1) window, the number one (1) door, the main door, or the number two (2) window for quite some time. Uh maybe an hour into it, eventually I saw smoke coming around the door and uh now I don't know that I ever did see anything major coming out of the number two (2) window, uh number one (1) window was still intact but it had been discolored from smoke. Uh I'm not sure of the exact time uh Deputy Morey was asking about the possibility of bringing C.D.F. in to fight the fire, I said yeah it's probably a good, good discussion at this point uh kept expecting the [REDACTED] to come out at any time, uh verbal commands from uh Deputy, Sergeant Fridley were continuous (inaudible) I could hear them, advising that the, the trailer was on fire and he needed to exit as soon as possible uh he never exited. C.D.F. came in started to extinguish the fire and my team moved up to provide support and I believe the C.D.C. team was also there. Uh that's about the end of it.

MH Was it C.D.F. or was it Hoopa Tribal (inaudible)?

RG Oh you know what it was Hoopa Tribal my, my apologies.

SQ And did you remain there until the fire was put out?

RG Uh it was mostly extinguished I remained there until there was confirmation that the [REDACTED] body was located and then uh I went with [REDACTED] she photographed the position where my team had been staged and we cleared out and let uh the fire department and investigators take care of the scene.

SQ And then you left the area with your team?

RG Yes we went back to the Command Post.

SQ And what did you do at the Command Post?

RG Uh we stayed there uh until we were contacted and lined up by Investigator Hislop and uh I'm not sure who the other person was, did a weapons check,

MH Honsal.

RG Honsal. Uh weapons check to see who had fired, who had not fired, asked us if uh we'd identified who had launched gas who hadn't, who had fired their weapons and then we uh left the scene.

SQ Okay. Being a S.E.T. Team member, have you received any specialized training?

RG Yes.

SQ What type of training have you received?

RG Uh basic uh the basic F.B.I. SWAT Academy, uh we train in all the new equipment on a monthly basis that we get and when we have monthly training as well um different uh, I can't think of the different schools I've gone to off hand uh I'm scheduled for another one (1) coming up here next week.

SQ Okay. In this particular incident what was your, what was your roll?

RG Uh Team Two (2) Leader, uh maintain things on the uh, on the Team Two (2) side, (inaudible) sure if it's north, south, east, west, (inaudible)

SQ Okay.

RG Which was the side with the, the main door and uh the number, the number, what was identified as the number one (1) side which had the main door and then another bedroom, which was the number two (2) side.

SQ How many people were on your team?

RG Initially the first time I was in there, I had uh myself, Brian Taylor, Dave Lundie, Todd Fulton, and I believe that was it. Yeah I believe that was it at that time and then uh when I went back in I had uh myself, Bishop, Todd Fulton, Tony Gomes, and Kevin Miller. Kevin Miller was also there the first time too also.

SQ And Kevin Miller is a Sergeant but he was not, his roll wasn't as a,

RG He was assistant team leader.

SQ Okay. And then the other team leader was Sergeant Quenell?

RG Yes.

SQ Okay. Ultimately who was the supervisor, of the overall supervisor of the S.E.T. Team?

RG Lieutenant Cavinta.

SQ Okay and at some point someone made the decision to utilize gas?

RG Yes.

SQ Who would that have been?

RG I believe it was uh Lieutenant Cavinta authorized it.

SQ Okay. Do you have any idea of what type of gas was utilized?

RG I don't, I wasn't on that side.

SQ Okay. And what was Sergeant Fridley's role in the incident?

RG Uh Hostage Negotiator or Negotiator, Critical Incident Negotiator.

SQ During the time period that you were around the residence and he was negotiating or attempting to negotiate, did you ever hear any of his dialogue?

RG Yes. Uh he continuously uh advised the [REDACTED] to lay down his weapons and come out, that uh he should surrender, um things, you know, things weren't to the point where they were bad yet you know there's always time to come out rescind this, you know you need to talk to us, have communication with us, uh lets work this out um, there was no response uh anytime that I was there other than uh around nine (9) o'clock when the [REDACTED] came to the window and fired what I hear later on was one (1) round.

SQ Okay and approximately what was your total time on scene?

RG Probably, well I'm not sure what time we uh, we left there um I arrived on scene at team two (2) location at about between eight forty five (8:45) and nine (9) o'clock I believe um and then was relieved at a little after two (2) uh was away from the scene, although I brought the other team back in, the E.P.D. Team. Was there for probably another half hour another forty five (45) minutes at that point uh left the scene then until about nine (9) o'clock the next morning when I got back in.

SQ Okay.

RG And uh was there until the conclusion so maybe a total of uh eight, (8) nine (9), ten (10) hours. I can't, without knowing the exact times I can't be honest about,

SQ Mm hmm, okay.

RG that.

SQ During the time period that you were there did, how many shots did you hear?

RG I, I really couldn't tell you um cause I was getting an echo off the side uh off the bank, um I know that I heard one (1) shot at the beginning and then there was an echo and then I heard uh um four (4) five (5) six (6) rounds, but there was also echo's coming back off, bouncing off the uh, down the gully and the a adjacent mountains so it's hard to say I, I, I know that later on people said that they fired a total of six (6) rounds uh on top of the uh the [REDACTED] firing so I

would have to say that there's a total of seven (7) fired, one (1) by the [REDACTED] and then six (6) by our by the other team um but at the time I couldn't tell you just because of the uh the acoustics in there.

SQ Okay. During the time period that Sergeant Fridley was attempting to negotiate or negotiating um do you know if he was talking on a P.A. system or a bullhorn?

RG I believe it was the uh P.A. system from the car um, that's I wasn't on that side but that's, that's what I had heard was that he was talking on C.D.C. I know used both the bullhorn and the P.A. system from a car.

SQ Again, during the time period that you were uh being utilized as a, as a S.E.T. Team member around the residence, did you ever notice any patrol units around the residence, fairly close?

RG Yes when I first got there, um all I saw were units, I'm not sure if they were our or tribal's um I know that there were some of ours and I know that tribal had some out there uh I didn't, there was one (1) further, further up and it was some sort of uh, um what do you call it uh, like a Expedition or something,

SQ SUV

RG SUV there you go, like an SUV up close and when I first got there that's where Quenell was, they were behind that and uh I don't, I didn't check to see whose unit it was, could have been ours, could have been Tribal's.

SQ Was there any markings on the vehicle?

RG Uh I didn't pay attention to it, I was fixated on the house.

SQ Okay.

RG And the back hatch was open so I didn't see anything on the back of it.

SQ Okay. Did you notice any other uh law enforcement type vehicles in that area?

RG Well there was multiple I mean,

SQ I mean close that would be involved in the?

RG Yeah there was one (1) closer than that that I saw um, I'm assuming that was a tribal vehicle uh and I only know that because that's what I was told.

SQ Okay.

RG But I did see another car up in front, I didn't go up to it because at that point it was in a danger area where the guy had been shooting.

SQ Uh so you don't recall or you don't um remember seeing any type of insignia's or anything on the?

RG I didn't pay attention to it.

SQ Okay.

RG I saw a light bars and white vehicles and,

SQ Okay.

MH Randy uh the [REDACTED] when he fired large or small caliber weapon, what did it sound like?

RG It sounded from where I was, it sounded louder and sharper, a louder sharper sound than uh than the two twenty three's (223) that were returned, but that may have been just because he was up on a higher level than where our team members were and he was closer to me um ours sounded you know fainter, uh quieter and um a little bit well it was like they were farther away.

MH Your um, you were the team leader for team two (2)?

RG Team two (2) yes.

MH Did your folks uh fire any gas?

RG No.

MH Introduce any gas, and did they uh fire any rounds?

RG No sir.

MH Okay. Uh how long have you been on S.W.A.T. Team, uh the S.E.T. team?

RG Ten (10) years.

MH How many just roughly, how many call outs have you been on?

RG Anywhere from fifteen (15) to twenty (20).

MH With this operation was it handled uh typically like any other operation would be handled uh through your training and policy (inaudible)?

RG Yes.

SQ Do you think that the [REDACTED] inside the house was given ample opportunity to surrender and come out?

RG Oh absolutely.

MH Did you hear any, at any time did he make any screaming or yelling or voices that you can recall?

RG Yeah we could uh, the first night that I was there um from the nine (9) o'clock to the two (2) something um I actually saw him in the number two (2) window, it looked like he was folding clothes or something in there um could hear him in there yelling at almost sound like he was having a conversation with somebody but we were told he was alone and there was no phone. Uh I don't know who he was talking to or what he was talking about um later on I heard him yell, you know "hey there's hand grenades all over this place" and uh you know almost like a threat you know don't come in there's hand grenades all over the place. I relayed that information to Lieutenant Cavinta, found out that uh by talking to the actual owner of the residence that there was a um de-armed hand grenade in there that was plugged and was not uh, not functional, um but I could hear him in there doing that and then uh E.P.D. Officers Cooper and uh um Harpham told me that they uh, they had seen him in there in that same back room it looked like he was folding clothes or doing something um they couldn't tell what he was doing uh during the time that they were there. Also I could hear him moving around in there and at one (1) point it sounded like there was metal on metal moving, like something was being pried open or grating across something, we couldn't identify that, I don't know what it was.

MH Did you saw you had, you had Deputy Fulton on your team?

RG Yes.

MH Did he, did he have night vision goggles?

RG Yes.

MH Did he make any mention to you that he was seeing some flickering inside the house?

RG Uh yeah I think he did and we weren't sure that was um,

MH Did he speculate at all what it could have been?

RG He said it, he said he maybe the guy is uh you know firing up a meth. pipe or something like that uh I said well maybe it's a blow torch and he's cutting open a gun safe or something, I don't know uh but I think we relayed that on the radio to the command post.

SQ How would you guys communicate back and forth to the individual team members and then back to the Command Van.

RG The team members on my side, we would just talk directly to each other and the rest of it was with our, our tack radios uh with the Command post you know identify you know ourselves or C.P. or Command Post Garcia, C.P. Command Post Team Two (2), Quenell Team Two (2).

SQ And again just for clarification from the position that you and your team members were located from that position uh, you couldn't see the gas being administered?

RG No uh we saw the teams making there approach uh and then they disappeared on they were obscured from view from the number four (4) side to us as they stepped beyond to the window, and then we could see them back off uh, could see the gas going in at all.

SQ And this was during the daylight hours?

RG Yes.

SQ Did you ever feel any of the effects of the, the gas?

RG Uh no we had a wind blowing uh coming from behind us towards the house uh where we were at and I uh understand that around the house was, on the other side of the house the number four (4) side was kind of moving in a circular uh pattern, uh a couple times the wind shifted to where it was coming directly at us and as soon as I felt it shift I told the guys to mask up just in case, cause we didn't want to become incapacitated uh I think we were maybe a hundred (100) and uh Bishop estimated it at one hundred and five (105) yards as a doing whatever sniper thing he, he did um which seem to be pretty safe but rather than take a chance of you know having it effect us we, we would mask up and then when it shifted we would uh take them off and uh and uh resume normal.

SQ Could you describe that residence for me?

RG Uh it appeared to be a uh, a trailer, a mobile home with a some sort of uh with wooden extension put on it but it was also wood sided um, it looked like it had plywood or something on it. It was painted uh, I believe uh dark color green uh with the exception of one (1) area on the number one (1) side near uh the number one (1) window that was a different color, it looked like it was just primer or something uh along that side. There was a wooden door uh up a couple of steps on the number one (1) side um facing my position, it was part of the uh, the extension that was on the trailer, uh mobile home whatever it was, uh it had an area underneath it that was covered by a wooden plywood skirting so it looked, that's what led me to believe it was a trailer uh had a metal tin roof, slight peak to it uh that's about it.

SQ Okay. Would you consider that individual that was inside the residence a threat?

RG Yes.

SQ And who was he a threat to?

RG Anyone that, I believe anyone in law enforcement or civilian that would get near that residence he would, is gonna be a threat.

SQ Okay.

MH And do you know there was no uh pyrotechnic type gas introduced?

RG Not to my knowledge no.

MH I don't have any other questions, that's good.

SQ Okay. That ends the taped statement at twelve ten (1210) hours.

End of transcript.

Transcribed on 9/17/07 by [REDACTED] 0608.

**Humboldt County Sheriff's Office
Supplemental Report**

Case #: 200703162

Date: 06/03/07

Charge(s): Investigation

Location: Bloody Camp Road, Hoopa, Calif.

State of Calif.

Reporting Party: Hoopa Tribal Dispatch

W-1 Hostler, William Eric D.O.B. Chief of Hoopa Tribal
Police, phone

W-2

W-3 McCovey, Thorin James Public Safety Officer
Yurok Tribal Police

W-4 Sgt. Mike Fridley C/O Humboldt County Sheriff's Office Hoopa
Station,

W-5 Deputy David Lundie C/O Humboldt County Sheriff's Office

W-6 Deputy Blake Massaro C/O Humboldt County Sheriff's
Office

W-7 Sgt. Kevin Miller C/O Humboldt County Sheriff's Office

W-8 Deputy Todd Fulton C/O Humboldt County Sheriff's
Office

W-9 Deputy Pat Bishop C/O Humboldt County Sheriff's Office

W-10 Sgt. Randy Garcia C/O Humboldt County Sheriff's Office

W-11 Deputy Jesse Taylor C/O Humboldt County Sheriff's Office

W-12 Deputy Kerry Ireland C/O Humboldt County Sheriff's Office

W-13 Tactical Dispatcher C/O Humboldt County Sheriff's
Office

W-14 Tactical Dispatcher C/O Humboldt County Sheriff's
Office

W-15 Dispatcher C/O Humboldt County
Sheriff's Office

Narrative: On 06/03/07 at approx. 2030 hrs. Sgt. Hanson contacted me at my residents via telephone. He requested that I respond to Bloody Camp Road in Hoopa to assist Det. Schlesiger. Det. Schlesiger was investigating a "shots fired" incident involving a "barricaded [REDACTED] with the Humboldt County Deputy Sheriff's personnel, Hoopa Tribal Police, Yurok Tribal Police and the California Highway Patrol.

At approx. 2300 hrs. I arrived and met with Det. Schlesiger. He briefed me on the current status of the "barricaded [REDACTED] and additional shots that were fired while I was enroute. Det. Schlesiger requested that I get a recorded statement from Hoopa Tribal Police Chief Hostler, [REDACTED], Yurok Tribal Officer Thorin McCovey, and Humboldt County Sheriff's Sergeant Mike Fridley.

At 2316 hrs. I interviewed Chief Hostler inside of my Detective vehicle that was parked on Bloody Camp Road. I used my digital recorder to record the interview. I later transferred the digital recording to a disk that I gave to Det. Schlesiger. The following is a summary of the interview; refer to the transcribed CD for complete details.

Chief Hostler said that he received a call from his dispatch, saying that Deputy Greg Berry from the Humboldt County Sheriff's Office was at the [REDACTED] residents. Deputy Berry told dispatch that [REDACTED] [REDACTED] had pointed a gun at him and he was requesting a back-up unit. The closest Hoopa tribal unit was transporting a prisoner to Eureka.

Chief Hostler requested a full call-out of his officers, Sgt. Guyer, Officer Norton, Officer Spallino and Officer Roberts was told via dispatch to expedite back to Hoopa for assistance at Bloody Camp Road. Chief Hostler requested a status check of Deputy Berry via dispatch and was told that [REDACTED] was still pointing the rifle at him. At this point Chief Hostler started responding code-3, (red lights and siren).

Chief Hostler arrived at 1605 hrs. with Sgt. Guyer behind him in his patrol vehicle. They drove down [REDACTED] driveway and stopped approx. 75 yds. from the residence that [REDACTED] was inside of. Chief Hostler saw someone standing inside of the house through a window on the south side of the house; the person was wearing a red shirt.

Chief Hostler and Sgt. Guyer stopped their patrol vehicles and talked to Deputy Berry. They confirmed that no one else was inside of the house with [REDACTED] [REDACTED] Sgt. Miller had advised via radio to have the units responding, including the C.H.P. unit, to set up a perimeter. Sgt. McCovey, from Tribal Police, along with Deputy Berry had the front door to the residence covered. Deputy Brian Taylor and Officer Spallino were with Chief Hostler and Sgt. Guyer at their patrol units. This was the main staging area.

Lt. Cavinta arrived and was talking to [REDACTED] ([REDACTED] Mom). Chief Hostler continued to see movement inside of the house. At approx. 1830 hrs. [REDACTED] opened fire towards Chief Hostler And Sgt. Guyer's patrol units. There were approx. 3 shots that were coming from the south side of the residence through an opened window. The first Hoopa patrol unit was struck twice in its hood and the second was struck once in

the hood. Deputy B. Taylor returned one shot with his rifle. When the shots struck the patrol units, Deputy Taylor was standing on the left side of the patrol unit and Officer Spallino was standing on the right side of the patrol unit. At this point everyone took cover and retreated except for Deputy Taylor and Officer Spallino. They maintained their cover at the patrol units that had been hit by gunfire.

Right after the shots were fired, the Humboldt County Sheriff's S.E.T. team members started to arrive. Deputy Ireland and Deputy Lundie were the first to arrive. Once all of the S.E.T. team arrived they started gearing up and moving forward. The Humboldt County Sheriff's Office tactical Dispatchers arrived and started maintaining a log of events.

At approx. 2100 hrs. a shot was heard whizzing through the air. Chief Hostler said that he was approx. 150 yds. from the house when he heard the shot. Chief Hostler heard at least 5-6 shots, just after the first shot, when Humboldt County Sheriff's S.E.T. returned fire. Chief Hostler said that Sgt. B. Quenell and two other S.E.T. members were the ones that returned gunfire. Other S.E.T. team members relieved Deputy Berry and the other Tribal Police that were originally on scene.

Chief Hostler said that he knew [REDACTED] [REDACTED] and knew that he had been arrested in the past for brandishing weapons, making death threats toward other people and minor issues with law enforcement. Chief Hostler said that [REDACTED] Mom had told him that [REDACTED] was [REDACTED] and when [REDACTED] he was okay. Chief Hostler said that the property and the trailer that [REDACTED] was inside of, belonged to [REDACTED]. He said that [REDACTED] and [REDACTED] were currently renting the trailer and property. Chief Hostler said that [REDACTED] was his Uncle and lived on the same property as the rental, but approx. 250 yds. up the road past the rental.

Chief Hostler said that earlier in the day [REDACTED] had showed up at the [REDACTED] residents acting paranoid. They tried to calm him down by having him lay down on their bed until Deputy Berry and Tribal Police arrived. [REDACTED] told them that he didn't want to go to [REDACTED]. [REDACTED] told [REDACTED] to take their son and leave due to [REDACTED] behavior.

When Deputy Berry and Tribal Officer Landreneaux arrived [REDACTED] got real excited and agitated. He had been outside of the house, but when he saw them, he went back inside of the house and got a rifle. [REDACTED] exited the house and pointed the rifle at Deputy Berry and Tribal Officer Landreneaux.

Chief Hostler said that he knew that [REDACTED] liked guns and in the past he was caught with a SKS rifle that he was firing it in the Housing Unit. Chief Hostler said that he was aware of other guns that [REDACTED] might have access to inside of the house. There was a .45 cal. pistol with three seven round magazines, AR-15 with two twenty round magazines, SKS semi-auto rifle with no ammo, 12 ga. shotgun with ammo and an unknown amount of .22 rounds for the rifle that he had pointed at Deputy Berry.

Chief Hostler said that on May 26 of this year that [REDACTED] was at [REDACTED] Mom's house and the Police had to be called. [REDACTED] was out of control; he had to be [REDACTED] because he was drinking gasoline and other caustic chemicals. [REDACTED] thought that he was already dead. [REDACTED] Mom had told Chief Hostler that [REDACTED] was [REDACTED] and after he was taken to [REDACTED] he

vandalized it's interior and the Eureka Police Dept. had to remove him and take him to the Humboldt County Correctional Facility.

Chief Hostler said that during this incident on Bloody Camp Road that he told [REDACTED] Mom, that this was the Humboldt County Sheriff's Office case and Hoopa Tribal Police was there to assist.

At 0019 hrs. I talked to [REDACTED] [REDACTED] inside of my Detective vehicle. I recorded our conversation on my digital recorder that was later transferred to CD. The following will be a summary of our conversation, refer to transcribed CD for complete details. I later gave the CD to Det. Schlesiger. [REDACTED] her boyfriend ([REDACTED]) and their son live in the house that [REDACTED] was inside of.

[REDACTED] said that earlier she was home washing dishes and heard a knock on the door. Her son answered the door and she heard a voice say "is your Dad home"? Her Son answered that his Dad can't move because a spider had bitten him. The voice that [REDACTED] heard then asked her son if he could come in and get a drink of water. [REDACTED] said that she never gave [REDACTED] permission to come inside of her house. She said that at first she didn't recognize [REDACTED] because of his long hair and facial hair. [REDACTED] said that [REDACTED] kind of startled her. She said that her son had to tell her that it was [REDACTED]. She said that she has known [REDACTED] since he was five years old. [REDACTED] didn't know what to think, she said that [REDACTED] had on a long trench coat.

[REDACTED] asked [REDACTED] where his Mom was and he said that he didn't want to speak with his Mom. He told her that he just needed help. [REDACTED] got scared at this point and left her house with her son to go to her neighbors. [REDACTED] phoned [REDACTED] mother and told her that [REDACTED] was at her house. She told [REDACTED] Mom that she needed to come and get [REDACTED]. Mom told [REDACTED] that she had already phoned for an ambulance and Tribal Police to meet [REDACTED] at the end of her driveway.

[REDACTED] said that she really didn't know what to do. She said that [REDACTED] was wearing big black boots, different colored gloves, one was blue rubber and the other one was white. [REDACTED] said that [REDACTED] was wearing a long trench coat and a beanie cap that kind of covered his face. She said that [REDACTED] was really sweaty and looked like he had been walking for miles.

[REDACTED] said that it was her neighbors, the [REDACTED], that gave [REDACTED] a ride to her driveway, just before he showed up at her house. [REDACTED] [REDACTED] repeated that she was in shock and really didn't know what was going on. She felt that her son had been traumatized from everything that was going on.

I asked [REDACTED] if she knew about any weapons that were inside of her house. She said that there might be a pistol and a rifle. [REDACTED] said that during the incident that she was nearby, at her Aunt's house and heard two shots, she then heard two return shots.

I asked [REDACTED] if [REDACTED] seemed normal when she talked to him and she said "no". She said that he was delusional and wasn't talking right. He was calling [REDACTED] his "Mom" and asking for help. He also told her that he loved her. She tried to fix him some food and offered him a cold shower, so he could cool off. [REDACTED] again said that [REDACTED] was really hot and sweaty.

I asked [REDACTED] if [REDACTED] was under the influence of anything and she said that he was not normal. She said that she never knew him to be on drugs. [REDACTED] said that she was starting to have an anxiety attack because she wasn't able to take her medication. She started crying, so I ended our conversation at 0027 hrs.

At 0053 hrs. I talked with Tribal Police Officer Thorin McCovey in regards to this incident. I recorded our conversation while sitting inside of my Detective vehicle with a digital recorder that I later transferred to CD-rom. This will be a summary of our conversation, refer to transcribed CD for complete details. I gave the CD to Det. Schlesiger.

Officer McCovey said that earlier in the day he copied radio traffic that Deputy Berry and Tribal Police Officer Landreneaux needed back up. He heard that the [REDACTED] that they were dealing with had knives and was brandishing them at Deputy Berry and Tribal Police Officer Landreneaux. Officer McCovey said that he expedited from Bald Hills Road and Martins Ferry and arrived at the incident scene at approx. 1540 hrs.

After Officer McCovey and Officer Landreneaux arrived, they were instructed by Chief Hostler to get on the hill above the house that [REDACTED] was in and observe the house from cover and concealment. Officer McCovey said that from where he was, that he couldn't see the [REDACTED] inside of the house.

When the first shots were fired, Officer McCovey couldn't see anything. I asked him how many shots he heard and he said that he heard one shot and then 4-5 shots in return. He said that him and Officer Landreneaux was approx. 300 to 400 yds. from the house, up on the hill.

Officer McCovey said that the door that the [REDACTED] came out of was on the west side of the house. He said that at no time did he ever have a visual on the [REDACTED] inside of the house. Officer McCovey said that he and Tribal Officer McKillip saw movement at windows on the east side of the house. Officer McCovey said that they copied radio traffic after shots were fired saying, "they fired at us", referring to Deputies that had been shot at.

Officer McCovey said that nothing else happened for a long time. He said that they watched the house for hours after the shots were fired. Officer McCovey said that it was just before 2100 hrs. when he heard the radio traffic saying, "windows open", then heard more shots. It sounded like the rounds that had been fired were whistling by their heads or coming in their direction. Officer McCovey said that it was one shot, and then 10-15 shots return fire. He estimated that it was ten minutes before 9:00 P.M.

Officer McCovey said that Tribal Officer Kevin McKillip and Tribal Officer Roberts were standing about 50' from him when the shots were fired. He said that none of their weapons were fired. I asked Officer McCovey if he knew or heard what Deputies or Officers fired their weapons. He said that he didn't know for sure. Officer McCovey said that he did hear that two of the Tribal's vehicles had been hit by gunfire. He said that he didn't find that out until approx. 2230 hrs, after he had been relieved from the hill he had been told to observe from. I asked Officer McCovey if he knew [REDACTED] and he said that he did not. Officer McCovey said that Tribal's function at this incident was for back-up only. My conversation with Officer McCovey ended at 0102 hrs.

At approx. 0244 hrs. I interviewed Sgt. Fridley inside of my Detective vehicle. I recorded our conversation on my digital recorder. I transferred the recording onto a CD that I later gave to Det. Schlesiger. Refer to transcribed CD for complete details of the interview. The following will be a summary of our conversation.

Sgt. Fridley is the Humboldt County Sheriff's Office Hoopa out station Supervisor. He said that at approx. 1530 / 1600 hrs. he was contacted at home via telephone from Humboldt County Sheriff's Office dispatcher in reference to this call. He was told that some Deputies had responded to Bloody Camp Road for a welfare check. When the Deputies arrived at the house off Bloody Camp Road, a [REDACTED] at that location had pointed a gun at Deputy Berry and then went back inside of his house. A negotiator call-out went into effect.

Sgt. Fridley arrived at the incident location off of Bloody Camp Road and met with Lt. Cavinta. He directed Sgt. Fridley to an area where [REDACTED] Mother and Dad were standing. Sgt. Fridley was seeking background information on [REDACTED] for negotiation purposes.

During his conversation with them, Sgt. Fridley heard several gunshots. One of the shots appeared to have come from the house that [REDACTED] was inside of. Sgt. Fridley said that it sounded like 1-2 smaller caliber shots and then 2-3 larger caliber shots.

Sgt. Fridley got into a marked Humboldt County Sheriff's unit with Deputy Daniels, who also had arrived on scene. Sgt. Fridley and Deputy Daniels are designated Humboldt County Sheriff's Office negotiators. They drove to the scene and parked behind other patrol vehicles and law enforcement personnel that were hiding behind the Tribal Police vehicles. Sgt. Fridley also saw that the two Tribal Police vehicles had been damaged from gunshots. Sgt. Fridley said that they were just observing the house at this point.

Sgt. Fridley and Deputy Daniels started negotiations with [REDACTED] over a PA system and got no response. They were approx. 40-50 yds. from the house. Sgt. Fridley said that S.E.T. members could hear [REDACTED] yelling, but no one could understand what he was saying. Sgt. Fridley first heard 3-5 shots while he was standing near the driveway and Bloody Camp Road. The shots sounded like smaller caliber at first and then larger caliber in return.

Sgt. Fridley said that the on-scene supervisor was Lt. Cavinta. He said that Deputy Daniels and him took turns negotiating. At one point when the shots were fired Sgt. Fridley heard what he thought was a ricochet that hit in the bushes near his location. After the ricochet, Sgt. Fridley said that S.E.T. members returned gunfire. He was later told that it was Sgt. Bryan Quenell and Deputy Gomes that returned fire. Sgt. Fridley said that a S.E.T. team member also told him that [REDACTED] at some point yelled, "mother fuckers come and get me". He said that he couldn't recall what S.E.T. member it was. This interview ended at 0256 hrs.

Refer to Detective Schlesiger's report for further details of our involvement while at the incident scene. The following will be summaries of [REDACTED] I interviewed regarding their involvement with this incident.

On 06/07/07 at approx. 1113 hrs. Humboldt County Sheriff's Senior Dispatcher, [REDACTED] came to my office at the Humboldt County Sheriff's Office Detective Bureau. I had requested that she give me a statement regarding her involvement with this incident. Humboldt County District Attorney Chief Investigator Mike Hislop was also present. I

recorded her statement on my digital recorder that I later transferred to CD-rom. I gave the CD to Det. Schlesiger along with the following summary of her statement; refer to transcribed CD for complete details.

██████████ said that she has been working at the Humboldt County Sheriff's Office for approx. 4 years in July. I will refer to ██████████ throughout this report as ██████████. ██████████ said that on 06/03/07 at approx. 1620 hrs. she was contacted at home, regarding her being called out for a barricaded ██████████ in the Hoopa area that was armed. ██████████ is a trained tactical dispatcher for this type of a situation. After contacting Lt. Cavinta, ██████████ responded with Det. Schlesiger to the barricaded ██████████ on Bloody Camp Road. At approx. 1824 hrs. they arrived and within five minutes they were standing outside of Det. Schlesiger's vehicle. ██████████ saw Lt. Cavinta talking with some of the barricaded ██████████ family members. It was during this time period that ██████████ heard shots being fired. ██████████ didn't recall how many shots she heard or what type of shots that were fired. Lt. Knight, who was already on scene, escorted ██████████ out of harms way.

██████████ met with Lt. Cavinta and members from the Tribal Police for incident briefing. During this briefing additional shots were fired and ██████████ was moved again. By now the Humboldt County Sheriff's Command van had arrived and ██████████ started keeping a log of the incident as it unfolded. Refer to her log for details. ██████████ said that she could hear Sgt. Fridley talking on a P.A. system attempting to communicate with the barricaded ██████████ with no response. ██████████ continued to keep a log until 0415 hrs. At that time a Eureka Police Dept. tactical dispatcher relieved her and continued documenting in the incident log. ██████████ Det. Schlesiger and I drove to Willow Creek and rested. We returned at 0645 hrs. ██████████ assumed the role of tactical dispatcher and continued maintaining a log.

At approx. 1100 hrs. ██████████ said that the Humboldt County Sheriff's S.W.A.T. team deployed gas into the residence. At approx. 1420 hrs. ██████████ started getting information that smoke was coming from the house that the barricaded ██████████ was inside of. At 1436 hrs. ██████████ was notified that fire was seen inside of the residence. At approx. 1545 hrs. fire trucks arrived on scene. After the fire was put out ██████████ had Sgt. Buihner transport her to the scene so she could contact Lt. Cavinta. At 1815 hrs. ██████████ cleared the scene.

On 06/07/07 at approx. 1145 hrs. Sgt. Garcia came to my office in the Humboldt County Sheriff's Office, per my request. I had requested that he give me a statement regarding this incident. Humboldt County District Attorney Chief Investigator, Mike Hislop and I conducted the interview inside of my office at the Humboldt County Sheriff's Office Detective Bureau. The following will be a summary of his interview. I recorded the interview on my digital recorder that I later transferred to CD rom. The CD was later transcribed. Refer to the transcribed tape for complete details of the interview. The original CD was turned over to Det. Schlesiger along with this summary.

I asked Sgt. Garcia if he could explain his involvement regarding this incident. He said that he was notified a little bit past 1700 hrs. on Sunday, the 3rd for a S.E.T. call-out. While he was enroute at approx. Hwy. 299 @ Blue Lake, he heard over his vehicle radio that shots had been fired at the scene. Sgt. Garcia said that he expedited his response to "code three."

Sgt. Garcia said that he arrived on scene at approx. 1815 hrs. He contacted S.E.T. Lt. Cavinta and S.E.T. Sgt Bryan Quenell. Sgt. Garcia was tasked with moving a S.E.T. team

up to the opposite side of the residence where the Yurok Tribal vehicles were parked. He said that it took them approx. 45 minutes to an hour to get to the location. Sgt. Garcia and his team contacted Tribal Officer Landreneaux and Deputy Greg Berry. They had a brief conversation regarding the situation. At approx. 2100 hrs. Officer Landreneaux and Deputy Berry were getting ready to leave the area when one large shot was fired and then several smaller shots. The shots were coming from the opposite side of the building from where Sgt. Garcia and his team were in place. Sgt. Garcia couldn't tell how many shots were fired because of an echo. He knew that there was at least one large sounding caliber and then several smaller ones that followed.

Sgt. Garcia said that he and his team stayed at their location until it got dark. He said that they moved closer to the Yurok Tribal vehicle because their night vision goggles wouldn't allow them to see clearly from their original position. At approx. 0200 hrs. Sgt. Garcia returned to the Command Post after leaving his team at the aforementioned location. He contacted Lt. Cavinta and Sgt. Bryan Quenell; also present was Eureka Police Dept.'s SWAT team. Sgt. Garcia was told to take the E.P.D. SWAT team back to where he had left his team, so they could be relieved. Sgt. Garcia and his team were relieved and they took a break back at the Command Post. All of the Humboldt County Sheriff's S.E.T. team members drove to the Hoopa outstation to rest.

At approx. 0900 hrs. they arrived back at the Command Post. Sgt. Garcia and Sgt. Quenell along with their teams went back to their tactical positions, relieving E.P.D. SWAT. Sgt. Garcia deployed Deputy Bishop above his team's location as a sniper to have a clear view of the front door and the #2 window. Sgt. Garcia had four S.E.T. team members with him that he rotated besides Deputy Bishop. These members kept a visual on the house from their positions. At approx. 1100 hrs. Sgt. Quenell's team on the opposite side of the house decided to utilize tear gas. During this time period Sgt. Garcia could hear C.D.C. hostage negotiator attempting to talk the barricaded [REDACTED] out of the house. After no response, Sgt. Quenell's team deployed tear gas. Sgt. Garcia said that for at least two or three hours no response came from inside of the house. Sgt. Garcia wasn't sure on the time, but someone that was on the opposite of the house said that they saw smoke coming from a window in the house. Shortly after that, Sgt. Garcia and his team saw a small trail of black smoke coming up from the far side of the house.

Deputy Bishop relayed to Sgt. Garcia that he could see the [REDACTED] on the floor in the #2 window. The [REDACTED] was covered up with some type of blanket, crawling on the floor during the deployment of the gas. Sgt. Garcia said that eventually the smoke got to the point where his team could actually see flames. The smoke started getting heavier and moving toward the trailer portion of the house. During this time period, Lt Morey had discussed with Sgt. Garcia about bringing in a firetruck. They kept expecting the [REDACTED] to come out at any time, as Sgt. Fridley continued to attempt to talk the [REDACTED] out of the house on a PA system. The [REDACTED] never came out and C.D.F. fire crew came in and started to put the fire out. Sgt. Garcia said that he stood by until Evidence Tech. [REDACTED] started processing the scene.

Sgt. Garcia said that he and the other S.E.T. team members returned to the area next to the Command Post and met with Chief Investigator Hislop and D.A. Investigator Honsal. A weapons check was conducted of all of the S.E.T. team member's firearms and their corresponding ammunition. Refer to Investigator Hislop's report for details.

Sgt. Garcia said that during this operation that he was the S.E.T. team leader for team #2. Sgt. Garcia said that the members on his team were Deputy Brian Taylor, Deputy Dave Lundie, Deputy Todd Fulton, and himself. Additionally Deputy Pat Bishop, Deputy Todd Fulton and Sgt. Miller were also part of Sgt. Garcia's team. Sgt. Miller was Sgt. Garcia's assistant team leader. Sgt. Bryan Quenell was team leader for team #1. Sgt. Garcia said that Lt. Cavinta was the overall supervisor for the entire Humboldt County Sheriff's Office S.E.T. team.

I asked Sgt. Garcia who ultimately made the final decision to utilize gas and he said Lt. Cavinta. Sgt. Garcia had no idea what type of gas was utilized. He said that Sgt. Fridley's role was as a hostage negotiator. Sgt. Garcia said that he could remember throughout the incident hearing Sgt. Fridley asking the [REDACTED] to lay down his weapons, surrender and come out of the building. Sgt. Garcia said that there was no response until around 2100 hrs, when the [REDACTED] came to the window and fired one shot.

Chief Investigator Hislop asked Sgt. Garcia if his team fired any tear gas at the house and he said "no". Investigator Hislop asked Sgt. Garcia how long he has been a S.E.T. team member and he said for ten years. Sgt. Garcia said that he has been on fifteen to twenty S.E.T. call-outs. Investigator Hislop asked Sgt. Garcia if he thought that the [REDACTED] inside of the house was given ample opportunity to surrender and he said "oh absolutely".

I asked Sgt. Garcia to describe the residence for me and he said that it was combination trailer and house. It was painted dark [REDACTED] in color. I asked him if he considered the [REDACTED] inside of the house a threat and he said "yes". I asked him who was the threat to and he said anyone in law enforcement or civilian that would get near the residence, he would be a threat to. Investigator Hislop asked Sgt. Garcia if he knew if any pyrotechnic type gas was used on the residence and he said, "not to his knowledge". The interview ended at 1210 hrs.

At 1415 hrs. Deputy Jesse Taylor came to my office per my request so I could interview him regarding this incident. Chief Investigator Mike Hislop was also present during the interview. I recorded the interview on my digital recorder that was later transferred to CD Rom. The following will be a summary of the interview, refer to transcribed CD Rom for complete details of the interview. Original CD was turned over to Det. Schlesiger along with this summary.

Deputy Jesse Taylor said that he has been working at the Humboldt County Sheriff's Office for five years. He has been a S.E.T. member for just over three years. Deputy Taylor said that his position on the S.E.T. team is an operator. He said that he has received special S.W.A.T. training with the F.B.I.

I asked Deputy Taylor to explain in his own words his involvement and observations relating to this incident. He said that on 06/03/07, some time after 1600 hrs. he got a phone call from Sergeant Bryan Quenell. Sgt. Quenell told Deputy Taylor that there had been a S.E.T. call-out and he wanted Deputy Taylor to meet him at the Sheriff's main office in Eureka. Once he arrived at the Sheriff's Office other members of the S.E.T. were present and everyone was briefed on the situation in Hoopa. The briefing described a barricaded [REDACTED] that had brandished a weapon at Deputy Berry.

Deputy Taylor said that after briefing that the S.E.T team members started enroute to Bloody Camp Road in Hoopa. He said that he rode with Sgt. Quenell and they arrived around 1700 hrs. or 1800 hrs. Shortly after their arrival, Deputy Taylor said that he heard a gun shot. Approx. five minutes later he heard additional gun shots. He said that the S.E.T. team started putting on their tactical gear and breaking up into teams. I asked Deputy Taylor what type of firearm he was carrying and he said the Department issued .40 Cal. Glock pistol and the Department issued .223 rifle. Deputy Taylor said that it was kind of a rush to get to where the Tribal patrol cars were parked and assist in any way that they could. Note; the Tribal patrol cars were parked in view of the barricaded [REDACTED] and this was where the shots appeared to have come from. For tactical purposes this side of the house was called side #4. Deputy Taylor described the two Tribal patrol cars as Ford Explorers. The cars were marked with the Hoopa Valley Tribal insignia or graphics on the sides of both patrol units. Both units had light bars on top.

After securing his position Deputy Taylor noticed that both Hoopa Valley Tribal vehicles had been shot. Both vehicles had broken windshields from being shot. When Deputy Jesse Taylor first arrived next to the Hoopa Valley units he noticed Deputy Bryan Taylor standing next to the first Hoopa valley unit that you would come to as you approached the barricaded [REDACTED] Deputy Jesse Taylor had heard from other S.E.T. team members that Deputy Bryan Taylor had returned fire after being shot at by the barricaded [REDACTED]

Deputy Jesse Taylor said that he stayed at this location for at least forty-five minutes to an hour. He said at one point that S.E.T. team member; Deputy Gomes had fired his rifle at the barricaded [REDACTED] Deputy Jesse Taylor estimated that the distance between the Hoopa Valley patrol units and S.E.T. members to the barricaded [REDACTED] was sixty-five yards. Deputy Jesse Taylor relieved Deputy Gomes from his position next to the Hoopa Valley patrol unit and pretty much stayed there for most of the night. Deputy Jesse Taylor was equipped with night-vision goggles and maintained a visual on the south side of the barricaded [REDACTED] house during the hours of darkness.

Deputy Jesse Taylor remembers throughout the evening hearing hostage negotiators, Sgt. Fridley and Deputy Daniels attempting to communicate to the [REDACTED] on a PA system. Deputy Jesse Taylor distinctively heard the [REDACTED] say 'motherfuckers bring it on'. Deputy Jesse Taylor said that he was approx. 10-15 yds. from the negotiators when they were talking on the PA system. Once it got dark Deputy Jesse Taylor could see lights on inside of the house from the tactically named B window on side #4 of the house. A flickering light was seen throughout the night coming from the A window on the #4 side of the house. A floodlight came on the exterior part of the house some time during the night but then was turned off.

At approx. 0300 hrs. the Eureka Police Dept. SWAT team arrived and relieved the Sheriff's Office S.E.T. team. The Sheriff's Office S.E.T. team all met back at the Command Post. It was decided that they all would respond to the Hoopa outstation for rest and discussions about their next assignments. During the assignment discussions at the Hoopa outstation, Sgt. Quenell was in charge per Deputy Jesse Taylor. Deputy Taylor said that Sergeant Garcia and Sgt. Kevin Miller were also present. Sgt. Miller had taken the position as a team sniper. Deputy Jesse Taylor said that the overall Supervisor for the operation was Lt. George Cavinta.

At approx. 0500 hrs. or 0600 hrs. after briefing at the Hoopa Outstation the S.E.T. team was split up. Deputy Taylor's team leader was Sgt. Quenell. The S.E.T. team responded

back to the incident location and relieved Eureka Police Dept. S.W.A.T. team. Tear gas plans had been discussed. The assignment was for all of the Humboldt County Sheriff's S.E.T. team members to return to their original locations prior to being relieved by E.P.D. S.W.A.T. At approx. 1115 hrs. gas was introduced into the house. Just prior to the gas being introduced Deputy Taylor said that C.D.C. personnel on scene were attempting to negotiate with the [REDACTED] via P.A. system. They were getting no response from the [REDACTED] Deputy Taylor said that after numerous rounds of gas were fired into the house, there was still no response. Deputy Jesse Taylor said that it was Deputy Barney and Deputy Brian Taylor that launched the tear gas into the house. I asked Deputy Jesse Taylor if he knew what type of gas was launched and he said CS and CN. He said that the gas was launched from a 37 mil. and a .12 gauge ferret round. I asked Deputy Jesse Taylor if he knew who gave the order to deploy gas, he said Lt. Cavinta. Deputy Jesse Taylor said that during the time that the gas was being deployed that negotiations continued with negative results. Deputy Jesse Taylor thought that the E.P.D. S.W.A.T. team had taken a position on the opposite side of the house that he was on and they also had deployed gas.

Deputy Jesse Taylor said that at one point they started to utilize canister gas. He said that it was deployed like a hand grenade. A ballistic blanket was utilized to shield Sgt. Quenell, Deputy Barney, Deputy Massaro, Deputy Brian Taylor and Deputy Jesse Taylor as they approached the house with tear gas. Deputy Barney introduced the first canister. Deputy Jesse Taylor thought that Deputy Barney was successful in throwing 2-3 canisters inside of the house. Once the canisters were thrown, they retreated back to the patrol cars and waited to see what affect the gas had on the [REDACTED]

Deputy Jesse Taylor said that after getting no response from the [REDACTED] with the first series of tear gas canisters that were thrown, Lt. Cavinta requested that Sgt. Quenell have his team deploy a second series of tear gas. Sgt. Quenell and Deputy Barney deployed the second series. Deputy Jesse Taylor didn't think that pyrotechnic gas was utilized. As far as he knew, the pyrotechnic gas was left inside of the patrol car. Deputy Jesse Taylor said that the gas that was utilized came from the C.D.C. team. During the second series of gas that was deployed, Sgt. Fridley continued negotiations via a P.A. system, with negative response from the [REDACTED] Deputy Jesse Taylor said that after awhile the white tear gas smoke turned to black, like something was on fire. He said eventually he could see flames coming from the house. Deputy Jesse Taylor said that eventually the house was fully engulfed and he could hear the sounds of loud popping or what sounded like gun shots coming from inside of the house.

Deputy Jesse Taylor said that he stood by until at least two fire trucks arrived to put the fire out. He said that his team walked back to the Command Van and waited for further instructions. Photographs were taken of the team members in uniform and of their equipment. A District Attorney Investigator inspected their equipment and firearms. Deputy Jesse Taylor rode back to the Sheriff's Main Office with Sgt. Garcia.

I asked Deputy Taylor if he considered the [REDACTED] in the house a threat. He said very much so. Deputy Jesse Taylor said that he was concerned for his safety during the entire incident. He also felt that the [REDACTED] was a danger to the community. Tape ended at 1500 hrs.

At 1510 hrs. Humboldt County Sheriff's dispatcher, [REDACTED] came to my office per my request. [REDACTED] was dispatching at the time this call came in. I taped our

conversation on my digital recorder, that later was transferred to CD rom. The following will be a summary of interview with [REDACTED] Refer to transcribed CD for complete details. Chief Investigator Mike Hislop was also present during the interview. The original CD was released to Det. Schlesiger along with this summary report.

[REDACTED] said that she has been working for the Humboldt County Sheriff's Office for approx. four years and four months as a dispatcher. She said that she was working on the day that this call came in from Tribal P.D. The call was a request from Tribal Police for the Sheriff's Office to do a welfare check, because all of their units were busy.

The call was dispatched to Deputy Berry who was doubled with a Yurok Tribal unit. He advised Dispatch that he would have an extended estimated time of arrival because he was responding from Weitchpec. [REDACTED] re-contacted Tribal dispatch and was told that the [REDACTED] that the welfare check was on was [REDACTED] [REDACTED] Yurok Tribal said that [REDACTED] was [REDACTED] earlier in the day. He had previously been in [REDACTED] At approx. 1500 hrs. Deputy Berry went out on scene and had met with [REDACTED] Mother and [REDACTED]

Deputy Berry's first status checked revealed that he was, "code four", and they still hadn't contacted [REDACTED] yet. [REDACTED] said that approx. 20 minutes later that Deputy Berry advised that the [REDACTED] was inside of the house, armed with knives and not being cooperative. Deputy Berry requested additional units respond to his location and expedite. C.H.P. was contacted and their closet unit was 25 minutes away. Hoopa Tribal units, 2408 and 2406 were enroute from Weitchpec. At approx. the same time Sgt. Miller was coming on duty and was advised about the situation, he told dispatch that he would be enroute.

Deputy Berry advised dispatch that [REDACTED] was pointing a gun at the units. He requested that all units responding expedite. [REDACTED] said that was when the Duty Officer, (Lt. Knight) was contacted. [REDACTED] said that Lt. Knight discussed the situation with Sgt. Miller and they decided to have a S.E.T. call-out. At approx. 1700 hrs. the back-up units started arriving on scene. Dispatcher [REDACTED] was contacted and requested to respond to the scene as a tactical dispatcher. Dispatcher [REDACTED] was contacted and asked to respond to the Sheriff's main office to relieve [REDACTED] so she could also respond to the scene and function as a tactical dispatcher.

[REDACTED] responded to the scene with Deputy Daniels in his patrol unit. They arrived on scene at approx. 1820 hrs. Dispatcher [REDACTED] had already arrived and was talking with [REDACTED] when shots were heard. [REDACTED] and [REDACTED] walked to Det. Schlesiger's vehicle, which was also on scene and waited for confirmation on what to do next.

[REDACTED] said that [REDACTED] started documenting what was taken place. Humboldt County Sheriff's S.E.T. team had arrived and was already moving into their tactical positions. The Command Van hadn't arrived yet, so the dispatchers were set up at Sheriff's vehicles that were parked at the scene. The dispatchers scribed all radio traffic that had to do with this incident. [REDACTED] said that the main radio traffic in the beginning was between Sgt. Quenell and Lt. Cavinta. At approx. 1900 hrs. negotiations started with Sgt. Fridley and Deputy Daniels over a P.A. system. It wasn't until 2100 hrs. that [REDACTED] heard other shots. A roll call was put into effect and everyone advised via radio that they were code-4. By then the Command van was on scene and patrol units were being moved out of the incident danger area. Between 2230 and 2300 hrs. the

Command van was completely operational. Around 2400 hrs. the [REDACTED] made threats about having hand grenades. Everything was quiet until [REDACTED] left at approx. 0100 hrs. with Lt. Knight. [REDACTED] said that [REDACTED] was the other dispatcher on duty when this call came in. [REDACTED] said that [REDACTED] actually took the original call from Tribal Police. [REDACTED] is in the process of training [REDACTED] due to her being recently hired. At one point information was relayed to [REDACTED] via Tribal Police that [REDACTED] was acting up and had said that he wanted to kill his Mother's youngest child.

[REDACTED] interview ended at 1520 hrs.

At approx. 1535 hrs. Humboldt County Sheriff's dispatcher trainee, [REDACTED] came to my office per my request so I could interview her regarding this incident. Chief Hislop was also present during the interview. I recorded the interview on my digital recorder and later transferred it to a CD rom. The following will be a summary of her interview, refer to transcribed recording for complete details. I gave the original CD to Det. Schlesiger to file with the case file.

[REDACTED] said that she has been working as a dispatcher trainee for approx. three weeks. [REDACTED] said that on June 3rd, while working in dispatch she received a call from Tribal dispatch stating that they needed a Deputy to do a welfare check. I asked [REDACTED] if she knew who the tribal dispatcher was and she said a male dispatcher, she didn't remember his name. She said that tribal dispatch had told her that the Mother of the [REDACTED] had phoned them requesting the welfare check.

[REDACTED] said that just prior to her dispatching anyone on the call that Officer Mike Roberts from Tribal Police had phoned her. He said that he had prior contacts with the [REDACTED] and knew that in the recent past that he had been placed in [REDACTED]. While he was at [REDACTED] he became violent and started destroying their property. Due to his demeanor, [REDACTED] requested that he be arrested and transported to the Humboldt County jail for booking. Officer Roberts told [REDACTED] that he had heard that the [REDACTED] had been telling people that he had a dream about wanting to kill his mother's child. [REDACTED] said that she relayed this information to [REDACTED]

[REDACTED] said that [REDACTED] relieved her from dispatching at 1500 hrs. [REDACTED] continued dispatching until [REDACTED] relieved her. [REDACTED] interview ended at 1540 hrs.

At approx. 1550 hrs. Deputy Kerry Ireland came to my office per my request so I could interview him regarding this incident. Chief Investigator Mike Hislop was also present. I recorded the interview with my digital recorder and later transferred it to CD- rom. The following will be a summary of the interview, refer to transcribed CD for complete details. I gave the CD-rom to Det. Schlesiger along with the summary and transcribed CD for the case file.

Deputy Ireland said that he has been working for the Humboldt County Sheriff's office for approx. five years. He is also a member of the S.E.T. team. He has attended the P.O.S.T. approved basic S.W.A.T. course along with certified basic sniper course. Deputy Ireland said that he attends on-going S.W.A.T. training with the Sheriff's office. He has been a member of the S.E.T. team for approx. three years. His position with the team is an entry and sniper.

Deputy Ireland said that he received a "page" around 1600 hrs. on Sunday. He said that he responded to the Sheriff's Office with Deputy Lundie and stood by for Sgt. Quenell and Sgt. Garcia to arrive. They briefed on the situation and then they drove to Pine Creek Road @ Bloody Camp Rd., Hoopa. Deputy Ireland said that they arrived at approx. 1800-1830 hrs. and within a few minutes shots were fired from the [REDACTED] house. Sgt. Quenell decided to utilize Deputy Bishop and myself as snipers. Deputy Ireland said that he believed that Deputy Brian Taylor, who was on point returned gunfire, after the [REDACTED] shot. He didn't know how many shots were fired. At approx. 1900 hrs. Deputy Bishop and Deputy Ireland were in position, approx. 56 yds. from the [REDACTED] residence. Deputy Ireland observed the [REDACTED] through his sniper scope open the #4A window. He saw a rifle barrel extend out of the window. Deputy Ireland called out his observations and the [REDACTED] fired 2-3 shots. Shortly after, Deputy Ireland said that the S.E.T. team returned fire. Deputy Ireland said that he saw the impact of the S.E.T. team's rounds hitting the wall and around the window of the [REDACTED] house.

Chief Hislop asked Deputy Ireland if he saw a scope on the [REDACTED] rifle. He said "no" that he didn't even see the [REDACTED]. Deputy Ireland said that the S.E.T. team fired approx. 6 shots. Deputy Ireland said that he believed that was the last time that the [REDACTED] engaged them with gunfire. He said that during the entire time communications was attempted with the [REDACTED] with no response. Deputy Ireland said that Deputy Bishop and himself could hear he [REDACTED] "babbling nonsense" that no one could clearly hear. Once the sun went down, Deputy Ireland and Deputy Bishop left their positions and went back to the Command Van. They geared up as an entry team. They put on their entry vests carried their M-16 rifles to a position near the rear of the [REDACTED] house. Deputy Ireland and Deputy Bishop utilized night vision goggles to watch the [REDACTED] movements inside of the house. Deputy Ireland said that he could tell from the [REDACTED] movements that he was not a normal minded person, he was fidgety, and he was talking to himself. Deputy Ireland said that the [REDACTED] had a television on during the entire incident and it was very loud.

Deputy Ireland said that he watched the [REDACTED] light a fire inside of a wood stove. He also could see a light flicker from another unknown source from inside of the [REDACTED] house. Deputy Ireland said that he could see that the [REDACTED] was wearing a "wife-beater" tank top. He said that he could smell the smoke from the [REDACTED] chimney.

Deputy Ireland said that they were relieved by E.P.D. and all of the Humboldt County Sheriff's S.E.T. team responded to the Hoopa Outstation at approx. 1700 hrs. They went to the Outstation to eat and rest up, have a briefing and then return to the incident location. Deputy Ireland said that during the entire incident, that Sgt. Quenell was his Supervisor. Sgt. Garcia was in charge of the other S.E.T. team. The overall supervisor was Lt. Cavinta. The negotiators were Deputy Daniels and Sgt. Fridley. The S.E.T. team had discussed utilizing gas on Monday. Making entry was going to be a final option due to the fact that the [REDACTED] had been shooting at them.

Deputy Ireland said that they had received Intel that the [REDACTED] had access to a gun safe with guns inside of it. There was also talk of the [REDACTED] having an AK-47 rifle or an SKS rifle and a pistol. The [REDACTED] possibly had a hand grenade. Deputy Ireland said that he would definitely consider the [REDACTED] a threat because 5 minutes after he got there the [REDACTED] shot. Deputy Ireland said that negotiations started shortly after he first arrived. He said that the negotiators that he was aware of were Deputy Daniels and Sgt. Fridley. He said that he could clearly hear the negotiators tell the [REDACTED] to come out, that it wasn't

so bad. That he needed to come outside and leave his weapon inside. They would tell him over and over again.

On Monday at approx. 0630 hrs. or just before 0700 hrs. their team had returned to the Command Post and was waiting for Sheriff's Office negotiators to be relieved by Eureka Police Dept. negotiators. Deputy Ireland said that his team didn't re-deploy until 0800 hrs. At approx. 0900 hrs. Deputy Ireland and Deputy Lundie returned to a sniper position, which was approx. 50 yds. from the #3 side of the [REDACTED] house. Between 1000 hrs. and 1100 hrs. negotiations began. Sgt. Fridley was the negotiator; he repeated what he was saying the night before that they needed to talk with [REDACTED]. They wanted to make sure that he was okay. Sgt. Fridley asked the [REDACTED] over his PA system to come outside and leave the guns inside. He told [REDACTED] that the situation wasn't that bad and to just come out and talk with him. The [REDACTED] [REDACTED] never responded to any of the negotiator's request. At approx. 1100 hrs. and 1200hrs. the Sheriff's Office S.E.T. team started using thirty-seven and forty millimeter gas canister launchers. Deputy Ireland didn't know who gave the final order to use gas. Deputy Ireland saw two malfunctions and after talking to Deputy Barney he was told that they quit using the thirty- seven-millimeter because of the mal-functions. E.P.D. started launching gas from their side of the house.

Deputy Ireland said that he could hear movement inside of the house after the gas canisters were launched. After every volley of gas, negotiations would begin, asking the [REDACTED] to exit the house without any weapons. The [REDACTED] failed to respond to the negotiators requests.

Deputy Ireland said that later in the afternoon that Sgt. Quenell and his team used a ballistic blanket to approach the house in a safe manner. They got close enough to use a porting tool to break out the #4 window and throw a CS grenade inside. Sgt. Quenell and his team retreated after throwing the grenade to observe what the [REDACTED] reaction would be. I asked Deputy Ireland who was on Sgt. Quenell's team. He said, Sgt. Quenell, Deputy Barney, Deputy Gomes and Deputy Jesse Taylor. Deputy Ireland thought there was another team member, but he couldn't remember who it was. I asked him who actually deployed the CS grenade and he said that he didn't know.

Deputy Ireland said that an unknown exact time later, Sgt. Quenell and his team approached the house a second time with the ballistic blanket and deployed another CS grenade. Deputy Ireland could tell that the second grenade was larger than the first one because of the amount of gas that was coming from inside of the house. He could tell that it was CS gas because the wind was blowing the gas in his direction. He said that the gas was burning his exposed skin around his neck, irritating his throat and stinging his eyes. Deputy Ireland said that he had to put his gas mask on so the gas would quit affecting him.

Deputy Ireland said that when Sgt. Quenell's team approached the house the second time, he was about seventy yards away from the house. He was standing next to Deputy Lundie, Eureka Police Officer Sanchez, Eureka Police officer Tim Jones. There were approx. five or six E.P.D. personnel with him, but he only knew Sanchez and Jones by their names. They noticed a change of color in the smoke that was coming from the house. Deputy Ireland felt that it was no longer gas that they were looking at coming from the house, but smoke something burning inside of the house. The smoke was coming from the #4 side of the house. He said that this was the side that the last two canisters were deployed into. Their smoke observation was relayed back to the Command

Van. Negotiations began again, right after the smoke was observed. Deputy Ireland said that there were several attempts to negotiate and communicate with the [REDACTED] instructing him to come out and follow the instructions. He could hear movement inside of the house and started seeing flames from the #4 side of the house. Deputy Ireland said that he heard four or five pops coming from inside of the house that sounded like small caliber gunfire. He heard a lot of movement coming from inside of the house on the #3 side, near the rear door. The #4 side of the house became engulfed in flames and was actively burning. The fire started moving from the #4 side of the house to the #2 side of the house, with no attempts by the [REDACTED] to exit.

Chief Hislop asked Deputy Ireland how much time went by from the time he saw smoke until the house was fully engulfed. He said it was a slow burn, approx. 30 minutes. Deputy Ireland said that most of the flames started on the #4 side of the house or the south side of the house. Chief Hislop asked Deputy Ireland if in his estimation, would a reasonable person have plenty of time to get out of the house after it caught on fire through the back door. He said most definitely because it was a slow burn.

I asked Deputy Ireland if he knew who deployed the gas the second time. He said that he didn't see who initially tossed it, but he knew there was a deployment error because the grenade didn't go inside of the house. He said that he believed that Sgt. Quenell picked the grenade up off the ground and got it inside of the house. Chief Hislop asked him if it was a smoke grenade and he said, "no", it was CS, a large CS grenade. Deputy Ireland said that he thought that there was only one grenade tossed on the second approach to the house.

Deputy Ireland said that once flames were observed on the #4 side of the house, that the Command Van requested fire crews to respond. Cover was provided for the fire crew by the C.D.C. SWAT team and the Humboldt County Sheriff's S.E.T. team. The fire crew cut through the #1 side of the house while fighting the fire. The hole they cut went directly into the house bathroom. The fire crew told Deputy Ireland that the [REDACTED] was lying on the bathroom floor. Deputy Ireland went to the hole that had been cut into the bathroom wall and saw the [REDACTED] lying on the bathroom floor, naked with what appeared to be burns on his body. Deputy Ireland said that it looked like the [REDACTED] had soot or ashes on his body. Deputy Ireland saw no movement coming from the [REDACTED] and felt that he was deceased by his appearance.

Deputy Ireland said that all of the Humboldt County Sheriff's S.E.T. team went to the Command Van to have the D.A. Investigators inspect their weapons and other equipment. Photos were taken of all of the S.E.T. team in uniform and of their weapons and equipment. Deputy Ireland said that once Sgt. Quenell cleared him to leave, that he left at approx. 1800 hrs. (Monday).

I asked Deputy Ireland what type of weapon he carried during this incident. He said a Glock, .40 caliber, and had forty-six rounds of Smith&Wesson .40 caliber ammunition. He said that he deployed with his Remington sniper rifle, model #700, .223 caliber. He had five rounds of match grade boat tail bullets loaded in the rifle and carried another twenty-seven rounds with him. I asked Deputy Ireland if at any time during the incident, did he fire either one of his weapons and he said, "no". I asked him what type of scope did he have on his rifle and he said a Leopold tactical 10x45 powered scope. I asked Deputy Ireland if he remembered seeing patrol units within the area where the incident occurred. He said "yeah", that he remembered at least one Yurok Tribal patrol car that

was approx. 100 yds. away from the house. The patrol unit was facing the #4a window. Deputy Ireland said that he thought that the [REDACTED] was shooting at the patrol vehicle. Hoopa Tribal had a patrol unit that was facing the #2, #3 corner of the house, it was on the road. The patrol units that were in the critical zone or within the [REDACTED] view were all marked with law enforcement markings. Deputy Greg Berry's patrol vehicle was parked on the #1, #2 corner of the house.

The patrol unit that was parked on the #4 side of the house had its driver door open and Deputy Brian Taylor was using it for cover and concealment. Deputy Ireland said that Sgt. Fridley also had identified himself as Mike with the Sheriff's Department. Deputy Ireland's statement ended at 1636 hrs.

N/F

Det. S. Quenell #0788
Det. S. Quenell #0788

10/25/07 1600 hrs.
Date/Time

Approved by Lt. G. Cavinta
#0527

Thu Jun 7 11:02:27 2007

CFS REPORT

ZONES: HC SHERIFFS OFFICE, HCSO PATROL GROUP, HC BEAT 42
CFS NUMBER: 060307-123 DATE/TIME REC'D: 06/03/07 14:04
CASE NUMBER: 200703162 DATE/TIME SENT: 06/03/07 14:09
INC CODE: WELF DESC: WELFARE CHECK DATE/TIME CMPL: 06/04/07 16:17

INC ADDR: BALD HILLS RD and PINE CRE APT#: CITY: HOOPA PH#:
COMP NAME: TRIBAL POLICE COMP ADDR: PH#:
IN PROG: OFF CONT: PRI: 2 WEAPON: ALARM: PRI UNIT: Q40
CALLTAKER: DISPATCHER:
FINAL DISP: REP

UNITS ATTACHED:

COMMENTS: 06/04/07 16:57 11K4 NOTIFIED
06/04/07 16:56 KIRKPATRICK REQUESTING CORONER
06/04/07 16:23 CFS CLOSED IN ERROR, DISREGARD THE CLOSING TIME OF 16:17
06/04/07 16:12 A7 REQUESTS OF DOJ PHONE HIM ON HIS CELL. MSG
DELIVERED.
06/04/07 15:45 HOUSE IS FULLY INVOLVED IN FIRE, UNITS ARE STILL STAGED
WAITING
06/04/07 14:45 FIRE ON SCENE. FIRE PERSONEEL ON SCENE
06/04/07 14:44 CODE 33
06/04/07 11:32 PER CP CODE 33
06/04/07 11:23 PER D11, GAS IS BEING USED NOW — o/a
06/04/07 10:41 CAVINTA NOTIFIED
06/04/07 10:39 IF NEEDED THEY WILL TRY TO GET SOMEONE THERE AS SOON AS
POSSIBLE.
06/04/07 10:39 AIR OPS ADVISES THEY WILL NOT BE ON STAND BY DUE TO THE
NATURE OF THE CALL.
06/04/07 10:36 AIR OPS FOR CHP INQUIRING IF AIR SUPPORT IS NEEDED TODAY.
06/04/07 06:08 A9 EN WITH PELICAN BAY NEGOTIATORS
06/04/07 05:38 A9 MEETING WITH PELICAN BAY NEGOTIATORS AT MCK STATION
SHORTLY
06/03/07 23:18 X15 TOOK EQUIPMENT TO EPD , EPD SWAT WILL BE EN TO
RELIEVE
SET TEAM
06/03/07 22:22 K25 AT WILLOW CREEK
06/03/07 22:11 HISLOP AND DUNN EN
06/03/07 21:50 PER A6, CANCEL CODE33
06/03/07 21:05 ALL UNITS CODE 4 AND ACCOUNTED FOR, CONTINUING C33 PER A7
06/03/07 20:55 SHOTS FIRED PER A7, CODE33 ISSUED PER A7
06/03/07 20:39 CANCEL CODE 33 PER A7
06/03/07 20:30 X25 ADVISES K25 WILL BE CLEARING SHORTLY FROM HIS RES
06/03/07 19:36 CORRECTION Y1043 EN FROM HIS RES AT 1927HRS, Y1043 HAD
BEEN OUT OF TOWN
06/03/07 19:27 Y1083 EN FROM HIS RES, WAS OUT OF TOWN
06/03/07 19:16 S/V ADVISED
06/03/07 19:16 CORRECTION, HAVE SOMEONE FROM CONTACT A6 ON
CELL PHONE
06/03/07 19:15 PER A7 KEEP CODE33 IN EFFECT FOR NOW
06/03/07 19:15 PER A6 HAVE SOMEBODY FAMILIAR WITH PHONE A6'S
CELL
PHONE
06/03/07 19:08 NO PHONE CONTACT WITH NEGOTIATIONS ON THE PA BY
FRIDLEY AND DANIELS
06/03/07 18:42 PER D11 THERE WERE SHOTS FIRED BY (3 SHOTS) AND
LAW ENFORCEMENT RETURNED FIRE UNK HOW MANY SHOTS
06/03/07 18:34 L12 STILL EN, ETA OF DRIVE TIME FROM WILLOW CREEK
06/03/07 18:32 COPIED CHP SCANNER TRAFFIC, 2 TRIBAL PATROL VEHICLES WERE

Thu Jun 7 11:02:27 2007

SHOT BY [REDACTED] [REDACTED] HAS NOW CLOSED WINDOW AND STOPPED SHOOTING

[REDACTED] 06/03/07 18:27 Y599 EN CODE3
[REDACTED] 06/03/07 18:26 UNABLE TO REACH L11 ON RADIO
[REDACTED] 06/03/07 18:26 HAVE L11 EXPEDITE PER X10
[REDACTED] 06/03/07 18:26 SHOTS FIRED PER X1
[REDACTED] 06/03/07 18:22 96 TO LOOP RD TO PINE CREEK, FOLLOW PINE CREEK ALL THE

WAY

BACK TO BALD HILLS RD, [REDACTED] THERE IS SHERIFFS

TAPE

MARKING LOCATION (PER TRIABL)

[REDACTED] 06/03/07 17:21 L12 CLEAR WITH COMMAND POST EN HOOPA
[REDACTED] 06/03/07 17:01 L12 PAGED
[REDACTED] 06/03/07 17:01 SGT QUENELL REQ THE COMMAND VAN RESPOND TO THE SCENE
[REDACTED] 06/03/07 16:49 MARKED ENTERENCE TO RD WITH SHERIFF'S TAPE
[REDACTED] 06/03/07 16:27 [REDACTED] ON PORCH STILL POINTING RIFLE
[REDACTED] 06/03/07 16:20 FLOOR PLAN OF THE RESIDENCE CREATED BY HOME OWNER.
[REDACTED] 06/03/07 16:17 X3'S FROM EAST FORK CAMPGROUND
[REDACTED] 06/03/07 16:17 [REDACTED] CONTINUALLY POINTING FIREARM AT UNITS.
[REDACTED] 06/03/07 16:02 ISSUED SET CALL OUT. (code - 9)
[REDACTED] 06/03/07 16:02 MOVE ANY SUVILLIANS OUT OF THE AREA.
[REDACTED] 06/03/07 16:00 VEHICLE OUT OF DRIVEWAY, APOX 200 FT FROM THE RESIDENCE.
[REDACTED] 06/03/07 16:00 SV ADVISED HE IS [REDACTED] AND HAS BEEN THERE

MULTIPLE

TIMES.

[REDACTED] 06/03/07 15:58 PER Q40 HE HAS TO SNEAK TO USE THE RADIO, SCANNER

TRAFFIC

[REDACTED] 06/03/07 15:57 LT KNIGHT, REQ A SET CALLOUT, CAMO GEAR MEET AT MAIN

STATION

[REDACTED] 06/03/07 15:57 PER X3 RUN A RAP ON [REDACTED]

[REDACTED] 06/03/07 15:57 CALLING SV TO GET HISTORY

[REDACTED] 06/03/07 15:55 DR number 200703162 assigned for agency HUMBOLDT CO

SHERIFF

[REDACTED] 06/03/07 15:55 [REDACTED] IS COCKING (SP) THE GUN

[REDACTED] 06/03/07 15:54 Q14 RESPONDING EAST W/ SET GEAR.

[cfsd] 06/03/07 15:53 Cross Streets : PINE CREEK RD * BLOODY CAMP RD

[REDACTED] 06/03/07 15:53 Inc Address changed to BALD HILLS RD and PINE CREEK RD at
15:53

[REDACTED] 06/03/07 15:52 PER Q40 [REDACTED] ALSO HAS A HAND GUN.

[REDACTED] 06/03/07 15:52 PER X3 GET A BETTER PERIMETER WHEN MORE UNITS ARE ON

SCENE.

[REDACTED] 06/03/07 15:52 PER X3 HOLD OFF THE AIR SUPPORT

[REDACTED] 06/03/07 15:50 CONFIRMED [REDACTED] STILL IN THE 22 W/ A SCOPE,

[REDACTED] 06/03/07 15:48 RED BANDANA, BLU JEANS, WET SUIT, TOP IS SLEEVELESS.

[REDACTED] 06/03/07 15:47 REQUEST TRIBAL UNITS BOLO FOR THE [REDACTED] THIN BLK

FACIAL

HAIR

[REDACTED] 06/03/07 15:46 NO LONGER SEE [REDACTED] IN RES ANYMORE, BACK DOOR THAT HE
POSSIBLY WENT OUT WITH, FACIAL HAIR BLK

[REDACTED] 06/03/07 15:45 CORRECTION: UNABLE

[REDACTED] 06/03/07 15:45 X1 IS ANABLE TO RESPOND, HE HAS HIS SON WITH HIM

[REDACTED] 06/03/07 15:40 PER X3 CALL OUT X1.

[REDACTED] 06/03/07 15:40 DUTY OFFICER NOTIFIED.

[REDACTED] 06/03/07 15:37 CHP IS 20-25 MINS OUT

[REDACTED] 06/03/07 15:35 WEAPONS IN THE RESIDENCE. UNK IF WEAPONS ARE LOADED.

[REDACTED] 06/03/07 15:35 ONLY OCCUPANT IN THE RESIDENT.

[REDACTED] 06/03/07 15:33 PER 2505 CALL OUT ADDITIONAL UNITS FOR TRIBAL.

[REDACTED] 06/03/07 15:33 CODE 33 POSTED

[REDACTED] 06/03/07 15:33 [REDACTED] POINTING A FIREARM AT DEPUTIES. REQUEST UNITS

EXPEDITE.

[REDACTED] 06/03/07 15:31 CHP WILL BE ENROUTE

[REDACTED] 06/03/07 15:30 REQUEST CHP FOR AN ADDITIONAL UNIT

[REDACTED] 06/03/07 15:29 [REDACTED] IN POSSESSION OF SEVERAL KNIVES REFUSING TO PUT
THEM DOWN, REQUEST 2505 EXPEDITE

Thu Jun 7 11:02:27 2007

06/03/07 14:31 TOLD MOTHER OF DREAM HE HAD TO KILL MOTHER'S YOUNG CHILD

06/03/07 14:31 2505 SPOKE W/ MOTHER THIS MORNING, SHE ADV VERY
06/03/07 14:30 2505 ADV JUST RELEASED FROM WHILE THERE BECAME VIOLENT

AND WAS MOVED TO HCCF

06/03/07 14:14 ARE IN TRAILER

06/03/07 14:14 RIGHT BEFORE WHI CROSS ON LEFT HAND SIDE, TWO WHI POSTS THAT SAY " TURN THERE

06/03/07 14:06 HOUSE IS LOCATED ON PROPERTY

06/03/07 14:06 ORIGINAL RP

06/03/07 14:05 IS STAYING WITH PH

06/03/07 14:05 CHECK

06/03/07 14:05 RELAYED THROUGH TRIBAL POLICE

06/03/07 14:05 LITTLE HOUSE, UNK FURTHER DESCRIPTION

06/03/07 14:04 JUST BEFORE WHI CROSS ON BALD HILL RD, TAKE A LEFT

14:04

VEHICLES:

PERSONS:

Type:

NAME:

SOC:

AGE:

HGT:

WGT:

DOB:

RAC:

SEX:

HAI:

EYE:

ARMED & DANGEROUS?

LSW:

MISCELLANEOUS:

Type:

NAME:

SOC:

AGE:

HGT: 510

WGT: 180 HAI: BRO

DOB:

RAC: I

SEX: M

EYE: BRO

ARMED & DANGEROUS?

LSW: RED BANDANA, BLU JEANS, WET SUIT, TOP IS SLEEVELESS

MISCELLANEOUS: SProb CR043027PS DO NOT DRIVE W/BA OF ANY AMOUNT DO NOT DRIVE W/OUT VALID CDL AND INSURANCE SUBMIT TO CHEMICAL

TEST FOR DETECTION OF ALCOHOL Other Description: VC23152(B)

AKA:

RUNTIMES ASSOCIATED WITH CALL:

UNIT	SUBUNIT	STATUS	TIME
11K4		DISP	16:56
		EN_ROUTE	17:21
		OUT_SCENE	18:46
		AVAIL	19:47
22A1		DISP	06:45
		EN_ROUTE	06:45
		OUT_SCENE	09:28
		AVAIL	15:28
2402		DISP	14:10
		EN_ROUTE	14:10
		OUT_SCENE	15:02
		CODE4	15:12
		OUT_SCENE	15:26
2406		AVAIL	00:28
		DISP	15:42
		EN_ROUTE	15:43
		OUT_SCENE	16:13
		AVAIL	01:19

Thu Jun 7 11:02:27 2007

2408		DISP	15:42
		EN_ROUTE	15:43
		OUT_SCENE	16:13
		AVAIL	01:19
2503		DISP	16:05
		EN_ROUTE	16:05
		OUT_SCENE	16:05
		AVAIL	01:03
2504		DISP	16:05
		EN_ROUTE	16:05
		OUT_SCENE	16:05
		CODE4	16:05
		OUT_SCENE	16:05
		OUT_SCENE	17:03
		AVAIL	03:40
		DISP	22:49
		OUT_SCENE	22:49
		AVAIL	17:06
2505		DISP	15:29
		EN_ROUTE	15:29
		OUT_SCENE	16:05
		AVAIL	03:41
25A1		DISP	16:01
		EN_ROUTE	16:05
		OUT_SCENE	16:05
		AVAIL	03:41
7K1		DISP	00:04
		EN_ROUTE	00:04
		OUT_SCENE	00:04
		AVAIL	16:17
		DISP	16:17
		OUT_SCENE	16:18
		AVAIL	21:28
7K5		DISP	00:03
		EN_ROUTE	00:04
		OUT_SCENE	00:04
		AVAIL	16:17
		DISP	16:17
		OUT_SCENE	16:18
		AVAIL	20:56
A2	DOWNEY	DISP	16:46
		EN_ROUTE	16:46
		OUT_SCENE	17:48
		AVAIL	20:55
A6	KNIGHT	DISP	16:24
		EN_ROUTE	16:24
		OUT_SCENE	16:32
		EN_ROUTE	17:16
		OUT_SCENE	18:52
		AVAIL	00:57
A7	CAVINTA	DISP	16:43
	CAVINTA	EN_ROUTE	16:43
		OUT_SCENE	20:04
		AVAIL	16:17
		DISP	16:22
		OUT_SCENE	16:23
		AVAIL	18:15
A9	MOREY	DISP	06:08
	MOREY	EN_ROUTE	06:08
		OUT_SCENE	11:11
		AVAIL	16:17
		DISP	16:17
		OUT_SCENE	16:18

Thu Jun 7 11:02:27 2007

		OUT_SCENE	22:50
		AVAIL	09:27
Q12	DIEMER	DISP	06:14
		EN_ROUTE	06:14
		EN_ROUTE	06:14
		EN_ROUTE	06:43
		OUT_SCENE	08:47
		AVAIL	17:06
Q14	LUNDIE	DISP	15:54
	LUNDIE	EN_ROUTE	16:06
		OUT_SCENE	08:58
		AVAIL	16:17
		DISP	16:18
		OUT_SCENE	16:19
		AVAIL	18:11
Q40	BERRY_G	DISP	14:10
		EN_ROUTE	14:10
		OUT_SCENE	15:02
		CODE4	15:12
		OUT_SCENE	15:26
		AVAIL	00:28
S18	BARNEY	DISP	17:58
	BARNEY	EN_ROUTE	17:58
	BARNEY	OUT_SCENE	20:04
		AVAIL	05:03
		DISP	05:04
		OUT_SCENE	05:04
		OUT_SCENE	11:12
		AVAIL	16:17
		DISP	16:17
		OUT_SCENE	16:18
		AVAIL	16:47
S45	MABRY_D	DISP	17:02
		EN_ROUTE	17:02
		OUT_SCENE	17:19
		AVAIL	21:58
X1	FRIDLEY	DISP	17:00
	FRIDLEY	PREWATCH	17:00
	FRIDLEY	OUT_SCENE	18:29
		AVAIL	03:52
		DISP	08:41
		OUT_SCENE	08:41
		AVAIL	16:17
		DISP	16:17
		OUT_SCENE	16:19
		AVAIL	17:16
X10	QUENELL_B	DISP	17:23
	QUENELL_B	EN_ROUTE	17:23
	QUENELL_B	OUT_SCENE	18:29
		AVAIL	05:03
		DISP	05:04
		OUT_SCENE	05:04
		OUT_SCENE	11:11
		AVAIL	16:17
		DISP	16:17
		OUT_SCENE	16:19
		AVAIL	18:16
X15	BUIHNER	DISP	05:44
	BUIHNER	EN_ROUTE	06:09
		OUT_SCENE	10:29
		AVAIL	16:17
		DISP	16:17
		OUT_SCENE	16:19

Thu Jun 7 11:02:27 2007

		AVAIL	11:00
X25	HANSON	DISP	06:58
	HANSON	EN_ROUTE	07:29
		OUT_SCENE	10:29
		AVAIL	16:17
		DISP	16:18
		OUT_SCENE	16:18
		AVAIL	12:43
X3	MILLER	DISP	15:36
		EN_ROUTE	15:36
		OUT_SCENE	16:48
		AVAIL	16:17
Y1004	TAYLOR_JA	DISP	17:23
	TAYLOR_JA	EN_ROUTE	17:23
	TAYLOR_JA	OUT_SCENE	18:29
		AVAIL	05:03
		DISP	05:04
		OUT_SCENE	05:04
		OUT_SCENE	11:11
		AVAIL	16:17
		DISP	16:17
		OUT_SCENE	16:19
		AVAIL	18:16
Y1026	TAYLOR_B	DISP	16:33
	TAYLOR_B	EN_ROUTE	16:33
	TAYLOR_B	OUT_SCENE	17:09
	TAYLOR_B	AVAIL	05:03
		DISP	05:04
		OUT_SCENE	05:04
		OUT_SCENE	11:11
		AVAIL	16:17
		DISP	16:18
		OUT_SCENE	16:18
		AVAIL	17:39
		DISP	18:59
		ENRT_HOSP	18:59
		OUT_HOSP	19:26
		AVAIL	19:50
Y1043	MASSARO	DISP	19:29
	MASSARO	EN_ROUTE	19:29
	MASSARO	OUT_SCENE	20:04
		EN_ROUTE	20:04
		OUT_SCENE	03:41
		AVAIL	05:03
		DISP	05:04
		OUT_SCENE	05:04
		OUT_SCENE	11:11
		AVAIL	16:17
		DISP	16:18
		OUT_SCENE	16:18
		AVAIL	17:39
Y1066	DANIELS	DISP	17:03
	DANIELS	AVAIL	17:20
		DISP	17:20
		EN_ROUTE	17:20
		OUT_SCENE	18:31
		AVAIL	03:58
Y1078	BISHOP	DISP	17:41
	BISHOP	AVAIL	17:58
	BISHOP	DISP	17:58
	BISHOP	EN_ROUTE	17:58
	BISHOP	OUT_SCENE	20:04
		AVAIL	05:03

Thu Jun 7 11:02:27 2007

		DISP	05:04
		OUT_SCENE	05:04
		OUT_SCENE	11:12
		AVAIL	16:17
		DISP	16:17
		OUT_SCENE	16:18
		AVAIL	16:47
		DISP	17:04
		OUT_SCENE	17:04
		AVAIL	17:39
Y1082	IRELAND	DISP	17:15
	IRELAND	EN_ROUTE	17:15
	IRELAND	OUT_SCENE	20:04
		AVAIL	05:03
		DISP	05:04
		OUT_SCENE	05:04
		OUT_SCENE	11:11
		AVAIL	16:17
		DISP	16:18
		OUT_SCENE	16:18
		AVAIL	17:35
Y1083	GOMES	DISP	17:15
	GOMES	EN_ROUTE	17:15
	GOMES	OUT_SCENE	18:27
	MASSARO	AVAIL	18:39
	GOMES	DISP	18:41
	GOMES	EN_ROUTE	19:27
		AVAIL	19:29
		DISP	20:03
		EN_ROUTE	20:04
		OUT_SCENE	20:04
		AVAIL	05:03
		DISP	05:04
		OUT_SCENE	05:04
		OUT_SCENE	11:11
		AVAIL	16:17
		DISP	16:18
		OUT_SCENE	16:18
		AVAIL	17:39
Y1085		DISP	17:15
		EN_ROUTE	17:15
		OUT_SCENE	20:04
		AVAIL	05:03
		DISP	05:04
		OUT_SCENE	05:04
		OUT_SCENE	11:12
		AVAIL	16:17
		DISP	16:18
		OUT_SCENE	16:18
		AVAIL	17:39
Y599	GARCIA	DISP	18:13
	GARCIA	EN_ROUTE	18:13
	GARCIA	OUT_SCENE	19:16
		AVAIL	05:03
		DISP	05:04
		OUT_SCENE	05:04
		OUT_SCENE	11:11
		AVAIL	16:17
		DISP	16:18
		OUT_SCENE	16:18
		AVAIL	17:53

SET OPERATION JUNE 3RD, 2007 1400 HRS.

LOCATION: BLOODY CAMP RD, HOOPA NEAR BALD HILLS AND PINE CREEK RD.

TYPE OF INCIDENT: BARRICATED [REDACTED]

1728 HRS: 2505 ADVISED [REDACTED] HAS NO ACCESS TO PHONE OR SCANNER INSIDE THE RESIDENCE.

1739 HRS: 2505 SAW MOVEMENT ON THE NE SIDE OF THE RESIDENCE, OPEN WINDOW.

1740 HRS: Q40 ADVISED [REDACTED] PUT A WHITE OBJECT OVER HIS GUN, UNK WHAT THE OBJECT IS..

1812 HRS: A7 IS ON SCENE TALKING WITH FAMILY MEMBERS.

1813 HRS: [REDACTED] YELLED FROM RESIDENCE " I'M GOING TO GET MY M16 AND WE'RE ALL GOING DOWN." "WHO WANTS TO DIE TODAY?"

1815 HRS: Y1085/Y1082 OS.

1823 HRS: X10 ON SCENE.

1823 HRS: SHOTS FIRED FROM INSIDE RESIDENCE.

1823 HRS: Q47 RETURNED ONE SHOT.

1825 HRS: K27 DISP [REDACTED] DANIELS, AND BISHOP ON SCENE.

1827 HRS: 25A1 ADVISES AR-15 AND AK-47 INSIDE THE RESIDENCE.

1828 HRS: REAR WINDOW CLOSED.

1828 HRS: Q40 CAN YOU HEAR NOISES?

1830 HRS: X1 ADVISES [REDACTED] IS NOW SHOOTING AT VEHICLES.

1830 HRS: A7 IS IN COMMAND.

1831 HRS: Q40 REQUESTING ON LOOKERS BE REMOVED FROM THE AREA.

1832 HRS: X1 ADVISES THAT WE HAVE RETURNED FIRE.

1836 HRS: IRELAND AND BISHOP HAVE SET UP ON THE S/E CORNER.

1839 HRS: [REDACTED] SEEN IN THE SE CORNER.

1842 HRS: Q40 ADVISES DOORS OPENING.

1842 HRS: Q40 ADVISES DOORS CLOSING AGAIN.

1846 HRS: [REDACTED] SEEN IN THE A WINDOW ON THE #4 SIDE.

1905 HRS: NEGOTIATIONS HAVE STARTED OVER THE PA.

1908 HRS: NO VISUAL ON THE [REDACTED]

1912 HRS: MOVEMENT IN THE REAR WINDOW.

1918 HRS: CLOSED WINDOW, NOW OPEN.

1980 HRS: COMMAND VAN O/S.

1920 HRS: [REDACTED] [REDACTED] CONTACTED AND ADVISED THERE IS AN SKS AND AR-15 INSIDE RESIDENCE, INFO RELEYED.

1933 HRS: NVG'S BEING SENT IN.

1938 HRS: MASSARO EN ROUTE AS OF 11 AGO.

1942 HRS: NVG'S NOW BEING SENT UP.

1943 HRS: SV ADVISES THAT THE [REDACTED] IS A [REDACTED].

1944 HRS: A7 ADVISES THAT Q40 AND 2402 PLUS A CIVILIAN ARE STUCK ON THE OPPOSITE SIDE OF THE HOUSE, UNABLE TO GET TO GET BACK, REQ A TEAM TO RELIEVE AND RESCUE UNITS.

1944 HRS: [REDACTED] YELLING OUT OF RESIDENCE.

1945 HRS: COMMUNICATIONS WITH PA AGAIN, NEGATIVE RESULT.

1958 HRS: A7 NOTIFIED EPD SWAT COMMANDER NOVA FOR ASSISTANCE.

2001 HRS: [REDACTED] IN THE LEFT SIDE WINDOW.

2002 HRS: IRELAND ADVISED [REDACTED] SET DOWN RIFLE NEAR A WINDOW #4 SIDE.

2002 HRS: PA STARTED AGAIN.

2005 HRS: GARCIA'S TEAM MOVING IN.

2008 HRS: X10 REQ 2ND SHIELD.L13 EN ROUTE

2019 HRS: MOVEMENT ON THE #4 SIDE.

2036 HRS: GARCIA'S TEAM IN POSITION.

2038 HRS: LIGHT ON SEEN FROM WINDOW ON THE NORTH SIDE.

2048 HRS: PUT RIFLE DOWN ON "LEFT" SIDE WINDOW.

2052 HRS: [REDACTED] BENT OVER TO PICK SOMETHING UP. [REDACTED] WEARING A RED HEAD BANDANA, HE IS SHIRTLESS AND FOLDING CLOTHES ON A BUNK BED.

2052 HRS: A7 ADVISES EPD'S ANTICIPATED ARRIVAL TIME IS 0200 WITH 8 TEAM MEMBERS AND 2 NEGOTIATORS.

2058 HRS: SHOTS FIRED, WE HAVE RETURNED FIRE, QUENELL, GOMES AND BARNEY INVOLVED.

2100 HRS: MOVING VEHICLES OUT OF THE ROADWAY.

2107 HRS: LT MOREY RELEYED TO A7 THAT CDC PELICAN BAY TO BE ON SCENE AT 0700 HRS JUNE 4TH, TEAM OF NEGOTIATORS.

2123 HRS: SNIPERS REQUESTING PULL OUT ON THE ¼ CORNER.

2123 HRS: SNIPERS PULLING OUT.

2130 HRS: STILL MOVING VEHICLES OUT AND RELOCATING COMMAND VAN.

2200 HRS: PER 25A1 WHO SPOKE TO [REDACTED] WHO ADVISES THAT [REDACTED] HAS 40 ROUNDS FOR THE AR-15, 3 FULL CLIPS, 45 ROUNDS FOR THE .45 AND 20 SLUGS FOR THE 12 GAUGE SHOTGUN. POSSIBLE ACCESS TO THE GUNSAFE INSIDE RESIDENCE.

2212 HRS: [REDACTED] WORKERS ON SCENE [REDACTED]

2212 HRS: REQ X1 SPEAK WITH [REDACTED]

2221 HRS: K25 ETA, DRIVE TIME FROM W.C.

2223 HRS: IRELAND AND BISHOP ON THE #3 "BACK DOOR.

2230 HRS: 2404 AND 2408 ADVISE KEYS TO THEIR VEHICLE IS IN THE VISOR.

2240 HRS: [REDACTED] MET WITH FRIDLEY AND DANIELS.

2257 HRS: [REDACTED] TALKING TO HIMSELF OR SOMEONE ELSE.

2300 HRS: [REDACTED]
[REDACTED].

2312 HRS: X10 EN ROUTE TO CHECK LOCATIONS AT THE C.P.

2327 HRS: ROLL CALL, ALL UNITS ACCOUNTED FOR.

2327 HRS: DOOR SLAM OR SOMETHING HIT THE GROUND PER JESSE TAYLOR.

2327 HRS: QUENELL BACK EN ROUTE TO #4 SIDE.

2340 HRS: THREATS OF GERNADES HEARD ON THE #3 SIDE.

2341 HRS: 2504,2505,2503 CLEARING THE SCENE.

0015 HRS: Q40 AND 2402 CLEARING THE SCENE.

0016 HRS: CELL PHONE FOR [REDACTED] [REDACTED].

0017 HRS: [REDACTED] CLEARING THE SCENE.

0020 HRS: A7 TRANSPORTING 25A1 TO HIS VEHICLE, X10 ADVISED.

0026 HRS: 25A1 TO A7 STATUS CHECK. C4

0030 HRS: DA INVESTIGATORS HISLOP AND DUNN O/S.

0130 HRS: X10 TO BISHOP THERE IS A MALFUNCTION?

0130 HRS: 25A1'S CELL PHONE [REDACTED].

0130 HRS: LIGHTS ON, ON THE #2 SIDE, RED LIGHTS SEEN.

0140 HRS: MOVEMENT ON THE #4 SIDE.

0148 HRS: GARCIA TO QUENELL, I'M COMING BACK

0201 HRS: [REDACTED] CAME NEAR THE #3 WINDOW WITH SOMETHING IN HAND, THEN WALKED AWAY.

0203 HRS: GARCIA @ THE C.P. QUENELL EN ROUTE TO THE C.P.

0206 HRS: QUENELL AT THE C.P.

0213 HRS: K27 ADVISED THAT PER [REDACTED] [REDACTED] HAS ACCESS TO A BULLET PROOF VEST THAT IS LOCATED IN THE MASTER BEDROOM, UNDERNEATH SOME CLOTHING. UNK IF THE [REDACTED] KNOWS IT IS THERE.

0230 HRS: EPD ON SCENE.

0233. BRIAN TAYLOR ADVISED FLASHLIGHT SHINING OUT OF WINDOW A ON THE 4 SIDE.

0236 HRS: BRIAN TAYLOR ADVISED FLASHLIGHT SHINING OUT OF WINDOW B ON THE 4 SIDE.

0237 HRS: DANIELS AND FRIDLEY EN ROUTE TO THE C.P.

0244 HRS: MOVEMENT ON NEAR 4B.

0257 HRS: POSSIBLE LIGHT ON NEAR 4B.

0257 HRS: [REDACTED] IN 4B.

0257 HRS: FLASHLIGHT OR EXTERIOR LIGHT ON.

0301 HRS: [REDACTED] SAID "BRING THE FLASHLIGHT TO ME."

0312 HRS: GARCIA EN ROUTE WITH COOPER AND HARPHAM.

0313 HRS: QUENELL MOVING EPD UP.

0318 HRS: [REDACTED] SHINED FLASHLIGHT.

0319 HRS. X1 EN ROUTE FOR OD.

0340 HRS: 2 OF 3 TEAMS IN PLACE.

0340 HRS: MASSARO, GOMES, BARNEY JESSE TAYLOR AND QUENELL BEING REPLACED BY EPD.

0352 HRS: WE STILL HAVE ONE TEAM AWAITING A GUY IN PLACE.

0405 HRS: HCSO TEAM 2 OUT CP.

0407 HRS: MILLERS TEAM EN ROUTE TO CP.

0430 HRS: EPD HAS CONTROL OF SCENE, HCSO RELEASED FOR BREAK PERIOD.

0700: X15 ON SCENE. X25 AND K28 ON SCENE AT THE HOOPA SUB.

0745 HRS: CDC PELICAN BAY ON SCENE WITH LT MOREY, SETTING UP.

0757 HRS: SO TEAM 1 MOVING INTO POSITION TO RELIEVE EPD.

0802 HRS: EPD RELIEVED, SO IN PLACE.

0802: IRELAND AND LUNDIE HOLDING THE #2 SPOT.

0833 HRS: 3B83 COMING OUT.

0842 HRS: ROLL CALL FOR ALL SO UNITS, ALL ACCOUNTED FOR.

0846 HRS: LT. MOREY MOVING CDC INTO PLACE.

0850 HRS: JESSE TAYLOR ADVISES THAT NEGOTIATIONS HAVE BEGUN.

0905 HRS: G10 EN ROUTE TO SCENE.

0910 HRS: TRIBAL PD MADE A REQUEST FOR B&B'S TO BE BROUGHT TO SCENE.

0915 HRS: X10 ADVISES NEGATIVE CONTACT WITH [REDACTED]

0920 HRS: X10 ADVISES ONGOING NEGOTIATIONS.

0924 HRS: CDC ADVISED STILL ATTEMPTING TO CONTACT [REDACTED] NO RESULTS, COMMUNICATIONS HAVE CEASED.

0926 HRS: CDC TEAM RETURNING TO C.P.

0927 HRS. MOTHER OF [REDACTED] IS ON SCENE. MOTHER HAS [REDACTED] DOCTOR ON THE PHONE WANTING TO TALK WITH SOMEONE.

0928 HRS: CDC AND X10 BACK AT C.P.

0936 HRS: ALL COMMUNICATIONS HAVE STOPPED COMPLETELY.

0944 HRS: UNITS GETTING IN POSITION TO GIVE [REDACTED] OPERATION COMMANDS. UNITS TO START VERBAL COMMANDS AT 1000 HRS.

0951 HRS: EPD SANCHEZ AND ALTIC POSITIONING ON THE 3/4 SIDE, REMAINDER OF THE TEAM WITH SO TEAM 1.

0958 HRS: STARTING WITH COMMANDS TO [REDACTED]

1000 HRS: CDC TAC TEAM STAGGED IN FRONT OF C.P

1001 HRS: COMM CHECK COMPLETE UNITS EN ROUTE TO STAGING LOCATION..

1011 HRS: REACH HAS AN ETA OF 1HR AND 15MIN, CHECKING WITH CHP FOR A FASTER RESPONSE.

1012 HRS: TEAM 1 IN POSITION ON THE 3/4 SIDE. TEAM 2 IN POSITION ON THE 1/2 SIDE. LUNDIE AND IRELAND ON THE 2/3 SIDE. SNIPER ON THE 1/2 AND THE 2/3 SIDE.

1022 HRS: TEAM 2 ADVISED TO STAY IN PLACE, 45 MINUTE STANDDOWN DUE TO EXTENDED RESPONSE FOR THE HELO.

1043 HRS: REACH DECLINED TO RESPONSE DUE TO NATURE OF CALL, CDF ADVISED THEY WILL NOT STAGE BUT WILL BE AVAILIBLE IF NEEDED WHEN SCENE C4.

1045 HRS: FRIDLEY BACK EN ROUTE TO GET COMMANDS STARTED.

1048 HRS: DELIVERING OPTIONS TO [REDACTED]

1051 HRS: COMMUNICATIONS BEGAN 5 AGO.

1052 HRS: X10 ADVISES COMMUNICATIONS HAVE HALTED WILL BEGIN AGAIN IN 5 MINUTES.

1057 HRS: TRIBAL CONTACTED AND ADVISED TO NOTIFY CDF HELO OF WHERE WE WANT THEM WHEN/IF THEY ARE NEEDED. PRIMARY LOCATION IS THE HOOPA LZ AND SECONDARY WAS THE LAT/LONG LOCATION.

1059 HRS: X10 ADVISED NEG COMMUNICATION WITH THE [REDACTED] AT THIS TIME.

1102 HRS: X10 ADVISED COMMUNICATIONS HAVE STARTED AGAIN.

1107 HRS: COMMUNICATIONS HALTED.

1111 HRS: COMMUNICATIONS STARTED.

1113 HRS: INQUIRY TO PROCEED???. A7 ADVISES AFFIRM, PROCEED.

1113 HRS: GAS GOING IN. 5 TO THE A/B ON THE #4 SIDE.

1119 HRS: IRELAND AND LUNDIES PORTABLES HAVE DIED, USE IRELAND CELL FOR COMMUNICATIONS.

1120 HRS: ANY MOVEMENT? NEGATIVE NO MOVEMENT.

1121 HRS: A7 TO X10, WAIT 5 MINUTES AND PROCEED WITH 5 TO THE A/B ON THE #4 SIDE.

1122 HRS: 3B83 IS EN ROUTE TO IRELAND AND LUNDIE'S LOCATION.

1123 HRS: IRELAND ADVISED TO GO TO GARMIN? , IRELAND ADVISED HE DOESN'T HAVE ONE.

1125HRS: 3B83 O/S WITH IRELAND.

1126 HRS: 2ND VOLLY TO START.

1128 HRS: CODE 33 ISSUED.

1132 HRS: ROUNDS HAVE BEEN ENTERED. NO MOVEMENT.

1135 HRS: BROKEN WINDOW #1 SIDE.

1138 HRS: X10 ADVISED SOUNDS LIKE BROKEN WINDOW ON THE #1 SIDE.

1138 HRS: BISHOP ADVISES [REDACTED] IS CRAWLING ON THE GROUND ON THE #2 SIDE NEAR MASTER BEDROOM.

1139 HRS: EPD MOVING INTO PLACE WILL NOTIFY WHEN THERE.

1140 HRS: FRIDLEY PREPARING FOR ANOTHER SURRENDER ORDER, IMMEDIATELY AFTER THE 5 SHOT VOLLY.X10 COPIES FOR FRIDLEY.

1143 HRS: EPD TEAM COMING UP AND ARE GOING TO DROP DOWN.

1147 HRS: EPD TEAM IS GETTING INTO POSITION, WILL TAKE A FEW.

1148 HRS: PELICAN BAY ADVISES 5 ADDITIONAL TAC PERSONNEL ON SCENE.

1154 HRS: 67 FOLLOW OUT PATH, 67 RAISE BISHOP.

1156 HRS? 64 ADVISES BISHOP THAT THEY NEED TO ENTER ON THE #2 SIDE.

1156 HRS: K64 INQUIRING THE RANGE? BISHOP ADVISES 105 YARDS.

1156 HRS: BISHOP ADVISES THAT HE HAS A VISUAL ON THE FRONT DOOR AND WINDOW. 64 TO BISHOP, CONFIRM IF WE STAY TO THE EAST OF THE BARB WIRE WE WILL NOT BE IN THE LINE OF FIRE? AFFIRM, YOU WILL NOT.

1156 HRS: K64 MOVING.

1200 HRS: PELICAN BAY DEBRIEFING THE [REDACTED] DOCTOR.

1203 HRS: 64 TO 67 84 YARDS.

1204 HRS: 67 SO GAS TEAM. AT YOUR DISTANCE HOW HIGH WERE YOU AIMING? TAYLOR-TOP OF THE WINDOW.

1205 HRS: G10 ON SCENE.

1205 HRS: 64 TO 67, I'M COMING BACK TO YOU.

1206 HRS. X10 TO A7, AS SOON AS EPD GETTING 10 IN, WE NEED TO DELIVER 10 IN. STARTING TO GET CROSS-WIND SITUATION, OUR UNITS ARE NOT FEELING THE EFFECTS EITHER.

1208 HRS: SO WILL SEND IN 10 FERRETS TO THE #4 SIDE AFTER EPD SENDS THERES.

1209 HRS: SEARCH WARRANTS SIGNED BY JUDGE CISSNA PER A7.

1210 HRS. 67 ADVISES 81 YARDS AWAY.

1211 HRS: L24 TELLS 67 TO PROCEED WHEN READY.

1211 HRS: 67- 23 STANDBY AND MASK.

1216 HRS: 67 TO 52 WANT US TO HOLD?

1216 HRS: 67 WE ARE PROCEEDING WITH GAS.

1219 HRS: WE HAVE 3 IN THE ROOM.

1220 HRS: WE ARE PUSHING THE LIMITS OF THE EQUIPMENT, WE HAVE 3 MORE NOW.

1221 HRS: L24 ADVISES 67 4 MORE WHEN HCSO DONE.

1222 HRS: X10 ADVISED WE ARE DONE.

1224 HRS: 67 ADVISES WE HAVE 4 IN.

1224 HRS: X10 GO AHEAD WITH SURRENDER ORDERS FOR 15 MINUTES PER A7.

1224 HRS: CODE 33 CANCELLED.

1237 HRS. 64 ADVISES POOR RANGE FOR FURTHER AGENT ON THE #2 SIDE REQUEST TO RELOCATE TO THE #3 SIDE DOORS FOR BETTER RANGE.

1239 HRS: X10 ADVISED COMMUNICATIONS CEASED.

1239 HRS: BISHOP ADVISES NEGATIVE MOVEMENT ON THE #2 OR #4 SIDE.

1253 HRS: L23 TO 83 CONFIRM YOU HEARD THAT TOO? STATIC? L23 ADVISED HEARING BANGING NOISES HEARD, NO VISUAL ON THE [REDACTED]

1254 HRS: BISHOP ADVISES MOVEMENT ON THE #2 SIDE [REDACTED] UNCOVERED HIMSELF FROM A LARGE THICK BLANKET.

1257 HRS: L23 PER 83 MOVEMENT POSSIBLY COMING FROM THE 2/3 CORNER, BISHOP CONFIRMED.

1258 HRS: K64 WE ARE ABOUT 5 OUT.

1258 HRS: [REDACTED] TRUCK IN THE TRAILER BELOW THE INCIDENT LOCATION IS LEAVING.

1302 HOURS. A7 INQUIRING CS POSSIBILITY? X10 ADVISED HE WILL WORK ON IT NOW.

1307 HRS: 67 ADVISED THEY ARE READY TO GAS.

1311 HRS: 67 ADVISED 4 IN ON THE 3 SIDE.

1311 HRS: X10 ADVISED THEY ARE GOING TO START PORTING WINDOWS.

1314 HRS: X10 ADVISES A7 THEY ARE ABLE TO PARTIALLY BREAK THE WINDOW BUT CAN'T GET A GERNADE THROUGH.

1315 HRS: X10 ADVISES THERE IS A FENCE BETWEEN THE HOUSE WOULD MAKE IT HARD TO MOVE UP SAFELY. WE NEED ONE ADDITIONAL SNIPER ON THE 4 SIDE TO COVER MOVE.

1317 HRS? 67 DO YOU WANT US TO DEPLOY ROUNDS ON THE 2/3 SIDE?

1319 HRS: L24 ADVISED 64 TO HOLD AND COVER.

1320 HRS: CDC IS EN ROUTE WITH 4 MEMBERS INCLUDING A SUAD LEADER AND TWO SNIPERS TO X10'S LOCATION.

1320 HRS: 25A1 RECEIVED INFO THERE IS POSSIBLY C4 INSIDE THE RESIDENCE, UNITS NOTIFIED.

1320 HRS: A7 ADVISED X10 OF ABOVE INFO.

1324 HRS: X10 ADVISED THAT LARGE HANDGUN SEEN ON A SHELF NEAR THE 4A.

1330 HRS: X10 ADVISED CDC IN PLACE AND WILL COVER WHILE TEAM SENDS IN CANISTER. CDC TO PROVIDE COVER FROM THE VEHICLE.

1330 HRS: UNITS WAITING FOR THE GO AHEAD.

1331 HRS: X10 ADVUSED CLEAR AND PROVEED.

1335 HRS: K28, G10 AND HISLOP EN ROUTE TO PINE CREEK TO SERVE SEARCH WARRANT.

1338 HRS: X10'S TEAM MOVING UP.

1339 HRS: X10 TEAM ONE IS MOVING UP.

1339 HRS: TEAM HALFWAY TO RESIDENCE.

1340 HRS: FRIDLEY ADVISED WINDOW 1 GAS INSERTED WINDOW B GAS INSERTED, START WITH SURRENDER. COMMANDS PER A7.

1341 HRS: TEAM IS BACK.

1344 HRS: PRODUCT DISCHARGED FROM CANISTERS.

1348HRS: GOOD INSERTION, NOT MUCH BLOW THROUGH. CONFIRMED LG SEMI AUTO ON THE 4A SIDE.

1350 HRS: A7 ADVISED X10 CDC HAVE ADDITIONAL CANISTERS IF NEEDED, FLAMLESS.

1353 HRS: UNITS INQUIRING ABOUT PYROS, FLAMLESS/SMOKELESS.

1355 HRS: X10 ADVISED CDC EN ROUTE WITH BLANKET AND HALOGENS.

1405 HRS: REQUEST FOR GAS TO 4 A AND B.

1406 HRS: A7 ADVISED CDC EN ROUTE WITH BLANKET AND VEST AGAIN.

1406 HRS: SO TO ENTER AGAIN ON THE 4A AND 4B SIDE.

1408 HRS: BLANKET JUST GOT TO THE VEHICLE, GETTING READY TO DELIVER.

1417 HRS: TEAM IS MASKED AND MOVIN FORWARD.

1418 HRS: TEAM HALFWAY TO RESIDENCE.

1419 HRS: THERE IS A DOG AT THE RESIDENCE, TEAM DEPLOYED AT WINDOW A ON THE 4 SIDE AND B ON THE 4 SIDE.

1419 HRS: SMOKE COMING OUT.

1420 HRS: TEAM IS HALFWAY BACK.

1420 HRS: TEAM IS BACK AT VEHICLE. COMMANDS ON THE PA STARTED AGAIN.

1420 HRS: SMOKE COMING OUT OF ROOF.

1424 HRS: CAN SMELL SMOKE AT THE C.P.

1428 HRS: COMMUNICATIONS ENDED.

1430 HRS: PERIMETER UNITS ADVISE NO MOVEMENT.

1432 HRS: GARCIA ADVISES NO SMOKE ON THE 2 SIDE.

1436 HRS: VERBAL COMMANDS TO THE [REDACTED] TO EVACUATE.

1436 HRS: L24 ADVISES WE HAVE FIRE ON THE INTERIOR, VERBAL SURRENDER TO [REDACTED] NOTIFY FIRE AND PERIMETER UNITS.

1437 HRS: L24 MAINTAIN MAXIMUM SURVEILLANCE 67 ADVISED THE 3 SIDE TEAM IS HOLDING.

1437 HRS: FIRE IS STAGGED WHERE THE C.P. WAS AND THE C.P. HAS RELOCATED FURTHER BACK.

1440 HRS: CODE 33 ISSUED.

1441 HRS: BLACK SMOKE COMING OUT.

1444 HRS: SMOKE IS INCREASING IN VOLUME PER CDC.

1444 HRS: BLACK SMOKE PER CDC.

1445 HRS: CONTINUING WITH VOICE SURRENDER, NO COMPLIANCE.

1445 HRS: WINDOW ON SIDE 1 COMPLETELY BLACK CANNOT SEE IN. APPEARS TO BE MOVING BACK TOWARDS THE #2 SIDE.

1447 HRS: STILL BLACK SMOKE GETTING WORSE.

1447 HRS: NO FLAMES SMOKE ON SIDE 4 WINDOW B. WINDOW A IS BLACK.

1449 HRS: 64 ADVISES THAT SOMETHING IS CHANGING ON THE 4 SIDE. SOMETHING FELL OFF THE WINDOW AND IS CHANGING COLOR.

1450 HRS: L24 ADVISED SMOKE AT 4A AND 4B.

1451 HRS: GARCIA ADVISED MILLER IS TRANSPORTING A RADIO TO BISHOP WHOS RADIO IS DEAD.

1452 HRS: CDC ADVISED BLACK SMOKE ON 4A AND 4B.

1455 HRS: L24 ADVISED NO CHANGE.

1459 HRS: CDC ADVISED SMOKE IS GETTING DARKER AND MORE INTENSE.

1500 HRS: CDC ADVISED MOVEMENT ON SIDE 4 POSSIBLY? GLASS FELL OUT OF WINDOW B. MAJORITY OF SMOKE.

1501 HRS: CDC ADVISED SIDE 3 AND 4 LOTS OF SMOKE.

1502 HRS: UNDERSHERIFF NOTIFIED.

1503 HRS: SMOKE COMING OUT OF WINDOW B ON SIDE 3 PER CDC

1504 HRS: 89 ADVISED THERE IS BANGING INSIDE, CDC ADVISED HEARING POSSIBLE SHOTS INSIDE RESIDENCE.

1505 HRS: SMOKE INTENSIFYING ROUNDS COOKING OFF OR SHOTS INSIDE RESIDENCE.

1507 HRS: T95 ADVISED SMOKE COMING OUT OF VENT 2/3.

1509 HRS. ROOF VENT #3 ON A/B.

1510 HRS: 1 ON THE 4 SIDE ALL ALONG ROOF.

1510 HRS: NO VISUAL ON ████████

1511 HRS: L24 AND A7 RETURNING TO C.P.NO VISUAL.

1511 HRS: TEAM 2 HAS VISUAL ON THE ½.

1511 HRS: LOST ALL VISUAL. HEARING FIRE CRACKLE IN THE RESIDENCE ON THE 4SIDE.

1513 HRS: TEAM 2 ADVISED TWO THUMPS INSIDE UNK IF THEY WERE FIRE RELATED.

1513 HRS: MP VISIBILITY ON THE # 3 SIDE.

1513 HRS: GARCIA ADVISES THE ½ IS STILL CLEAR.

1514 HRS: STILL NO SMOKE OUT OF THE SIDE 2 WINDOW.

1515 HRS: CDC ADVISE FLAMES ON THE 4 A AND B WINDOW.

1515 HRS: CDC ADVISE FLAMES ON SIDE 3.

1516 HRS: SMOKE IS PURGING WINDOW 2 ON THE 2 SIDE.

1516 HRS: LOST VISIBILITY IN ROOM, POSS IN ATTICK ROLLING DOWN.

1517 HRS: CDC ADVISED SIDE 4 IN KITCHEN IS FULLY INVOLVED-WHOLE TRAILER.

1521 HRS: THERE IS A VEHICLE PARKED IN DRIVEWAY 10 YDS FROM THE TRAILER.

1522 HRS: FULLY INVOLVED TRAILER FIRE.

1524 HRS: WALKING THE FIRE TRUCKS IN AND MOVING THE OTHER VEHICLES OUT OF THE WAY.

1524 HRS: GARCIA ADVISES SMOKE EXCITING THE FRONT DOOR.

1527 HRS: X1 REQUESTING A CAN OF PAINT TO MARK VEHICLE PLACEMENT.

1530 HRS: TEAM 2 ADVISES STILL NO SMOKE ON THE 1 OR 2 SIDE.

1531 HRS.A9 WANTS TO CHECK WITH 25A1 ON THE LOCATION OF PROPANE TANKS IF ANY.

1532 HRS: THERE IS A PROPANE TANK ON THE NORTH # 3 SIDE.THERE IS ALSO A SMALL 5 GALLON BY THE STAIR #1 SIDE.

1532 HRS: ALL UNITS ON SIDE 3 PULL BACK TO A SAFE LOCATION WHERE YOU CAN STILL MAINTAIN VISUAL.

1534 HRS: CODE 33 CANCELLED.

1536 HRS: HCSO CLEARING ROADWAY SO FIRE CAN GET TO STRUCTURE.

1540 HRS: SHOTS STILL COOKING OFF. NO SMOKE STILL ON WINDOW 1 AND WINDOW 2. FLAMES SEEN ON THE ¼ FLAMES SEEN.

1541 HRS: TEAM 2 MINOR SMOOKE ON SIDE 2 MORE ROUNDS.

1543 HRS: GOOD IDEA TO BRING FIRE IN ON THE 2 SIDE.

1543 HRS: OBSCURED ½ NOT SMOKE.

1546 HRS:CDC ADVISED THE CORNER 3 COLLAPSED ON THE ¾.

1548 HRS: FIRE ARRIVING AT STRUCTURE.

1548 HRS: TEAM 2 MOVING TO PROVIDE SECURITY FOR FIRE ON THE #1 SIDE.

1603 HRS: ALL EPD UNITS BACK AT THE CP STANDING BY FOR RELEASE ORDER.

1630HRS: EPD RELEASED FROM SCENE. CDC LEAVING SCENE.

1700 HRS: FIRE STILL ON SCENE BATTLING FIRE.

1730 HRS: MOST HCSO SET MEMBERS BACK AT CP.

1730 HRS: CHAPLAIN IS ON SCENE AND TALKING WITH FAMILY MEMBERS.

1745 HRS: US DOWNEY ON SCENE.

1800 HRS: ALL HCSO SET MEMBERS CLEAR FROM THE INCIDENT LOCATION AND BACK AT THE C.P.

1815-1830 HRS: HCSO UNITS BACK EN ROUTE TO EUREKA .

Names and Badge numbers of Pelican bay State Prison, CRT Operators that assisted Humboldt Co. Sheriff and Eureka Police department on June 4, 2007.

Commander, J. Ricker; 44913
Tactical Leader, R. Swift;
Negotiations Leader, D. Higgerson; 54841

Negotiators

A. Dornback; 42709
R. Mazyck; 62094
D. Barneburg; 56876
F. Vanderhoofven; 11860
A. Harrison; 66537
R. Berry; 60073

Tactical Operators

A. Navarro; 54929
J. Tygart; 52360
P. Martinez; 43591
J. McMillan; 63571
M. Winningham; 57974
J. Espitia; 37284
B. Patton; 38344
J. Lawrence; 59458
K. Charlton; 43894

IPS:

Disp. [REDACTED]

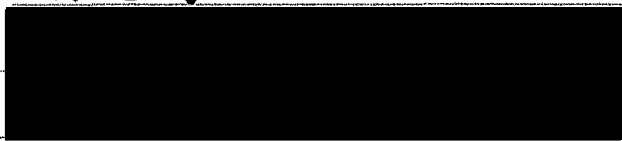

IIC Cavintu
Knight

SET:

HNT:

Miller TL
Queneu TL
Garcia TL
Lundie
J. Taylor
B. Taylor
Ireland
Barney
Gomes
Fulton
Bishop
Massaro

Dunleis
Fridley

Med/Fire
Staged behind CP

3 side

Ireland
Bishop

Tact. Free

① Garcia TL	② J. Taylor
Lundie	Gomes
Brian T	Massaro
Miller	Barney
Fulton	Queneu TL

Secondary
SO Main

1 1/2 side

4-side

**HUMBOLDT COUNTY SHERIFF'S OFFICE
SPECIAL ENFORCEMENT TEAM**

SECTION 1 – INCIDENT PROFILE

Date of Incident: 01/4/07 Time of Incident: _____

Location of Incident: _____

Officers Involved:		
Last Name, First Name	Assignment	Notes
1. Miller ATL	1/2 side	T2
2. Guria TL		
3. Barney	1/2 side	T2
4. Gomez		
5. Fulton	1/2 side	T2
6. Bishop		
7. Queneu TL	3/4 side	T1 unaid 213
8. unaid		
9. Jesse Taylor ATL	3/4 side	T1
10. Brian Taylor		
11. Freizna	3/4 side	T1 Freizna 213 side
12. Massard		
13.		
14.		
15.		
16.		
17.		
18.		

Perimeters(s)	Location	Comments
Inner Perimeter		
Outer Perimeter		

Command Post	Location	Comments
S.E.T.		
H.N.T.		
Fire		
Evacuation Site		
Medical Site		

**HUMBOLDT COUNTY SHERIFF'S OFFICE
SPECIAL ENFORCEMENT TEAM**

DR#
200703162

SECTION 1 - INCIDENT PROFILE

Date of Incident: 06/03/07 Time of Incident: 1400

Location of Incident: Dine Creek/Bald Hill Rd

Officers Involved; Last Name, First Name	Assignment	Notes
1. Miller, Kevin	# 1 DOOR	
2. Garcia, Randy	# 1 DOOR	TEAM leader
3. Queneau, Bryan	# 4 A/B Windows	Team Leader
4. Unai, David	# 1 DOOR	
5. Taylor Jesse	# 4 A/B Windows	
6. Taylor, Brian	# 1 DOOR	
7. Ireland, Kemy	# 3 B. DOOR	
8. Barney, Jamie	# 4 A/B Windows	
9. Gomes, Tony	# 4 A/B Windows	
10. Fulton, Todd	# 1 DOOR	
11. Bishop, Pat	# 3 BACK DOOR	
12. Massaro, Blake	# 3 BACK DOOR	# 4 A/B Windows
13.		
14.		
15.		
16.		
17. Frately, Mike	HNT	# 4 side on roadway
18. Daniels, Jason		

Perimeters(s)	Location	Comments
Inner Perimeter	immediat surrounding	
Outer Perimeter	NONE	due to terrain

Command Post	Location	Comments
S.E.T.	on scene	
H.N.T.	on scene	# 4 on roadway.
Fire	staged	Near the "cross"
Evacuation Site	command post	entrance to road.
Medical Site	staged	Near the "cross"

**HUMBOLDT COUNTY SHERIFF'S OFFICE
SPECIAL ENFORCEMENT TEAM**

Notifications	Responding	ETA	Comments
<input checked="" type="checkbox"/> Sgt.	Miller Cavenell	On Scene	
<input checked="" type="checkbox"/> Duty Officer	Knight	On Scene	
<input checked="" type="checkbox"/> SET Cmdr.	Witter/Cavinta	On Scene	
<input checked="" type="checkbox"/> Sheriff	Done via Au 1830		
<input checked="" type="checkbox"/> Fire/EMS	stugged	On Scene	S staged NEAR THE CROSS

Radio Frequency	Frequency #	Established Y/N
Primary	[REDACTED]	Y
Tactical	1 - "	Y

HUMBOLDT COUNTY SHERIFF'S OFFICE
SPECIAL ENFORCEMENT TEAM

SECTION 2 – LOCATION OF INCIDENT

Address/Landmark: Dine Creek Rd / Bull

Location Type (Check all that apply)

<input type="checkbox"/> Building
<input type="checkbox"/> Conveyance
<input type="checkbox"/> Open Air
<input type="checkbox"/> Other

If Building, Select Type (Choose ONE)

<input type="checkbox"/> Commercial Building
<input type="checkbox"/> Government Building
<input checked="" type="checkbox"/> Single Family Residence
<input type="checkbox"/> Town House/Condo/Apartment
<input checked="" type="checkbox"/> Other: <u>Single Trailer</u>

Number of Levels: _____

Number of Rooms: _____

If Building, Select Fortifications (Choose ONE)

<input type="checkbox"/> No Unusual Fortification
<input type="checkbox"/> Light Fortification
<input type="checkbox"/> Heavily Fortified

If Conveyance, Select Type (Choose ONE)

<input type="checkbox"/> Sedan/Passenger Car
<input type="checkbox"/> Van
<input type="checkbox"/> Pick-up/sport Utility Vehicle
<input type="checkbox"/> School Bus
<input type="checkbox"/> Commercial Bus
<input type="checkbox"/> Train
<input type="checkbox"/> Aircraft
<input type="checkbox"/> Other:

HUMBOLDT COUNTY SHERIFF'S OFFICE
SPECIAL ENFORCEMENT TEAM

SECTION 3- INCIDENT TYPE

Type of Incident (Choose ONE)
<input checked="" type="checkbox"/> Barricaded Person
[REDACTED]

If Warrant, Warrant Type (Check All that apply)
<input type="checkbox"/> Felony Arrest
<input type="checkbox"/> Search
<input type="checkbox"/> Other:

If Warrant, Reasons for Warrant (Check all that apply)
<input type="checkbox"/> Explosives
<input type="checkbox"/> Firearms
<input type="checkbox"/> Narcotics
<input type="checkbox"/> Wanted Person
<input type="checkbox"/> Other:

If Barricade, Barricade Type (Check All That Apply)
[REDACTED]
If Barricade, Reasons for Barricade (Check All That Apply)
<input type="checkbox"/> Deliberate Hostage Taker
<input type="checkbox"/> Disgruntled Employee
<input type="checkbox"/> Disgruntled Employer
<input type="checkbox"/> Domestic Dispute
<input type="checkbox"/> Interrupted Crime in Progress
<input type="checkbox"/> Kidnap for Ransom
<input type="checkbox"/> Termination of Pursuit
<input type="checkbox"/> Warrant Turned Barricade
<input type="checkbox"/> Other [REDACTED]

**HUMBOLDT COUNTY SHERIFF'S OFFICE
SPECIAL ENFORCEMENT TEAM**

SECTION 4 - [REDACTED] / [REDACTED]

[REDACTED]

N [REDACTED] [REDACTED]

Gender: M F Age: 24 Race: I Height: 601 Weight: 220

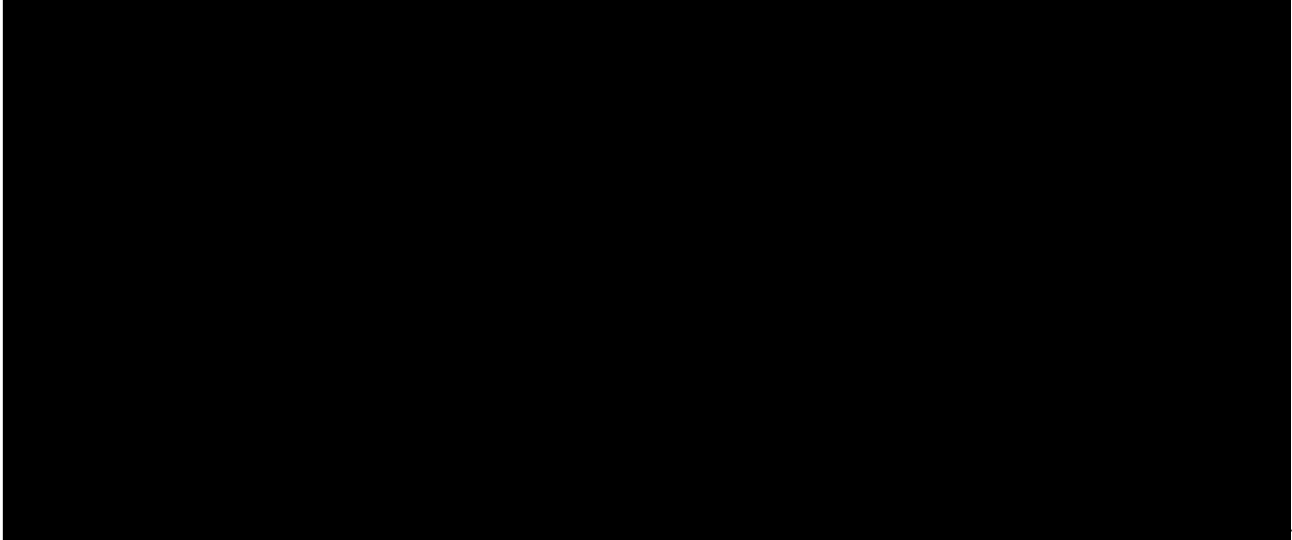

- Gas Mask
- Ballistic Armor
- Military Uniform or Variation
- Police Uniform or Variation

Type	# of Guns
<input type="checkbox"/> Handgun, Revolver	
<input checked="" type="checkbox"/> Handgun, Semi - Auto	<u>unk</u>
<input type="checkbox"/> Rifle, Bolt Action	
<input checked="" type="checkbox"/> Rifle, Semi - Auto	<u>?</u>
<input type="checkbox"/> Rifle, Other	
<input checked="" type="checkbox"/> Shotgun	
<input checked="" type="checkbox"/> Automatic Weapon	<u>unk</u>

- Other Weapons (check all that apply)**
- Edge Weapon
 - Vehicle
 - Blunt Impact
 - Other: (specify)

Explosives (check all that apply)	
Check if Possessed	Check if Used
<input type="checkbox"/> Black Powder	
<input type="checkbox"/> Booby-Trap	
<input type="checkbox"/> Dynamite	
<input type="checkbox"/> Hand Grenade	
<input type="checkbox"/> Hazardous Material	
<input type="checkbox"/> Hoax Device	
<input type="checkbox"/> Incendiary Device	
<input type="checkbox"/> Military Ordinance	
<input type="checkbox"/> Pipe Bomb	
<input type="checkbox"/> Plastic Explosive	
<input type="checkbox"/> Smokeless Powder	
<input type="checkbox"/> Other: (specify)	

HUMBOLDT COUNTY SHERIFF'S OFFICE SPECIAL ENFORCEMENT TEAM

SECTION 4 – [REDACTED] CONTINUED

[REDACTED]

Number of Shots Fired by the [REDACTED] Prior to Deployment of the Tactical Team: 3

Who were the shots directed at: (check all that apply)
<input type="checkbox"/> No one/ Random
<input type="checkbox"/> Civilians
<input checked="" type="checkbox"/> Deputies
<input type="checkbox"/> Structure
[REDACTED]
<input type="checkbox"/> Other:

Firearm offender discharged (check all that apply)
<input type="checkbox"/> Handgun, Revolver
<input type="checkbox"/> Handgun, Semi - Auto
<input type="checkbox"/> Rifle, Bolt Action
<input type="checkbox"/> Rifle, Semi - Auto
<input type="checkbox"/> Rifle, Other
<input type="checkbox"/> Shotgun
<input type="checkbox"/> Full-Auto Weapon

Who was injured/killed by offender's actions (check all that apply)
<input checked="" type="checkbox"/> No one
<input type="checkbox"/> Offender
<input type="checkbox"/> [REDACTED]s)/Hostage(s)
<input type="checkbox"/> Deputy (s)
<input checked="" type="checkbox"/> Other: <i>vehicle damage</i>

[REDACTED]

Demand made	[REDACTED]		
<input type="checkbox"/> None	<input type="checkbox"/> Yes <input type="checkbox"/> No	<input type="checkbox"/> Yes <input type="checkbox"/> No	
<input type="checkbox"/> Cigarettes	<input type="checkbox"/> Yes <input type="checkbox"/> No	<input type="checkbox"/> Yes <input type="checkbox"/> No	
<input type="checkbox"/> Food	<input type="checkbox"/> Yes <input type="checkbox"/> No	<input type="checkbox"/> Yes <input type="checkbox"/> No	
<input type="checkbox"/> Money	<input type="checkbox"/> Yes <input type="checkbox"/> No	<input type="checkbox"/> Yes <input type="checkbox"/> No	
<input type="checkbox"/> Water	<input type="checkbox"/> Yes <input type="checkbox"/> No	<input type="checkbox"/> Yes <input type="checkbox"/> No	
<input type="checkbox"/> Transportation	<input type="checkbox"/> Yes <input type="checkbox"/> No	<input type="checkbox"/> Yes <input type="checkbox"/> No	
<input type="checkbox"/> Other:	<input type="checkbox"/> Yes <input type="checkbox"/> No	<input type="checkbox"/> Yes <input type="checkbox"/> No	

HUMBOLDT COUNTY SHERIFF'S OFFICE
SPECIAL ENFORCEMENT TEAM

SECTION 5 - [REDACTED] / [REDACTED]

Number of [REDACTED] [REDACTED] involved in incident: _____

Enter [REDACTED] [REDACTED] profile information for each [REDACTED]. If more than three, reproduce this section.

#1 [REDACTED]

Name: (optional) _____

Gender: M F Age: _____ Race: _____ Height: _____ Weight: _____

Relationship to offender (Choose one)

<input type="checkbox"/> None/Stranger
<input type="checkbox"/> Family Member (specify)
<input type="checkbox"/> Employer

<input type="checkbox"/> Acquaintance
<input type="checkbox"/> Employee
<input type="checkbox"/> Other (explain)

Photo [] Yes [] No

#2 [REDACTED]

Name: (optional) _____

Gender: M F Age: _____ Race: _____ Height: _____ Weight: _____

Relationship to offender (Choose one)

<input type="checkbox"/> None/Stranger
<input type="checkbox"/> Family Member (specify)
<input type="checkbox"/> Employer

<input type="checkbox"/> Acquaintance
<input type="checkbox"/> Employee
<input type="checkbox"/> Other (explain)

Photo [] Yes [] No

#3 [REDACTED]

Name: (optional) _____

Gender: M F Age: _____ Race: _____ Height: _____ Weight: _____

Relationship to offender (Choose one)

<input type="checkbox"/> None/Stranger
<input type="checkbox"/> Family Member (specify)
<input type="checkbox"/> Employer

<input type="checkbox"/> Acquaintance
<input type="checkbox"/> Employee
<input type="checkbox"/> Other (explain)

Photo [] Yes [] No

Da's Office

HISLOP	6/4/07
Dunn	6/4/07
Honsal	6/4/07

Other personnel

chaplain. 

Pelican Bay CNT

Higgenson TIL

Dornbeck ATL

Mazyck

Barnburge - 2nd

Berry

Harrison

Vanderhooft van

P.B. TAC Team

Ricker

Martinez

Milano

Lawrence

Day 2

6/4/07

0400

- CDC w/ MOREY
DA system time??

- Set options
- Surrender - resolve
- CIA

- Volly Announcements
- Introduce CIA

- wait/-

- Port shields



HUMBOLDT COUNTY DISTRICT ATTORNEY'S OFFICE
INVESTIGATION REPORT
CASE: HCSO #200703162

TABLE OF CONTENTS

Date: July 20, 2007

Investigator: William Honsal

- I. EPD Negotiator **Kay Howden**
- II. EPD Dispatcher [REDACTED]
- III. EPD Negotiator **Edward Wilson**
- IV. EPD SWAT Officer **Todd Wilcox**
- V. CDC SWAT Team Leader **Jeff Ricker**
- VI. CDC Negotiators
 - a. Sergeant **D. Higgerson**
 - b. Sergeant **A. Dornback**
 - c. Sergeant **D. Barneburg**
- VII. EPD SWAT Officer **Rodrigo Reyna-Sanchez**
- VIII. EPD SWAT Officer **Ron Harpham**
- IX. Hoopa Valley Tribal Police Officer **Mike Roberts**
- X. CDC Assistant Team Leader **Rawland Swift**
- XI. EPD Officer **Gary Cooper**
- XII. EPD **Weapons Log**



HUMBOLDT COUNTY DISTRICT ATTORNEY'S OFFICE INVESTIGATION REPORT

DATE: July 2, 2007
CASE: HCSO #200703162

WITNESS: Kay Howden, Eureka Police Department

DA Investigator: William Honsal

On June 7th, 2007 at 2045 hours, I interviewed Officer Kay Howden, Eureka Police department, regarding HCSO case # 200703162. I was assisted in the interview by Detective Kevin Lawson. The interview was recorded on cassette and the following is a summary of her statement. For a detailed statement refer to attached transcript of the interview.

Kay Howden is currently a Sergeant with the Eureka Police Department. She has been employed as an officer with the city of Eureka for 19 years. She is currently assigned as a hostage negotiator for the Eureka Police Department. She received specialized training as a hostage negotiator from the POST school in Monterrey. Howden has been deployed as a hostage negotiator three times.

On June 3rd, 2007, Sergeant Howden received a page notifying her of the SWAT callout. Sergeant Nova advised Howden regarding the incident. Sgt. Nova requested EPD Negotiators Howden and Eddie Wilson respond to the scene to relieve the HCSO Negotiators.

At 0130 hours, Howden arrived at the scene, Bloody Camp Road and [REDACTED] road. Howden and Wilson contacted the HCSO negotiator, Deputy Daniels, at the Command Post. Daniels briefed them on the situation. The briefing included that fact that the [REDACTED] had fired a rifle at officers on two different occasions. The last time the [REDACTED] fired his rifle was when HCSO was attempting to negotiate with [REDACTED]

At approximately 0200 hours, Howden and Wilson Responded to the Southeast side of the residence. Howden and Wilson stood by the two tribal police SUV's. Their orders were to remain quiet at that location unless the [REDACTED] presented himself. At that time they would have actively negotiated a surrender. Howden and Wilson stood by out of sight of the residence behind the far east Police SUV, for their safety.

From their position, approximately 40 yards away, of cover they only took short "peeks" at the residence. Howden observed a light on through the #4, B window. And one time during the night she also observed "Movement" through that window. At no time during the night did Howden see or hear the [REDACTED]. At no time did another officer notify her that the [REDACTED] was in a position to surrender or talk with the police. Based on the fact that it was a quiet night and there were no other sounds

around in this area, Sergeant Howden believed if the [REDACTED] wanted to give up and call out for help, she would have heard it.

At 0500 hours, Sergeant Howden observed that they were closer to the house that she realized. At that time she felt it was necessary to move further east and out of sight of the [REDACTED] residence.

At 0700 hours, Officer Nova, advised the SWAT team to stand down. Sergeant Higginson, California Department of Corrections (CDC), relieved Sergeant Howden, as lead negotiator. Higginson and CDC were briefed on the situation at the Command Post. Sergeant Howden and Wilson gathered their equipment and subsequently left the scene at approximately 0800 hours.

Sergeant Howden advised that during the time she was on scene, 0200-0700, there were no shots fired and contact was never made with the [REDACTED] [REDACTED]

Disposition: Supplemental report referred to HCSO.

1
2
3
4
5
6
7
8
9
10
11
12
13
14
15
16
17
18
19
20
21
22
23
24
25
26
27
28
29
30
31
32
33
34
35
36
37
38
39
40
41
42
43
44
45

INTERVIEW WITH KAY HOWDEN

Q=Inv. B. Honsal

A=Kay Howden

Q: ...Investigator, ah, Bill Honsal, ah, Humboldt County District Attorney's Office, ah, with (Kevin Lawson), EPD, ah, here to interview Kay Howden, ah, regarding the, ah, incident that occurred off of [REDACTED] Road in Hoopa. Um, Kay, can you spell your last name for the recording here?

A: H-O-W-D-E-N.

Q: Okay. So, um, basically we're here to talk to you. You're a witness, um, ah, regarding the incident the SO had a shooting up at Hoopa at the – at the residence that you were called to over the weekend. So, ah, first thing's first. Um, I like to, ah, ask about your current assignment and then, ah, your training and experience. How long you been in law enforcement, any specialized training you've had, and so forth and so on, if you can just start on that?

A: My current assignment is – well for the City of Eureka is as a full sergeant. That was effective basically just a couple days before this started.

Q: Mm-hm.

A: But as it pertains to this incident, I'm a member of the hostage negotiation team along with Ed Wilson and ([REDACTED]). And on Sunday evening of this past weekend I received a call at home from Sergeant (Nova) advising that there was a barricaded [REDACTED] in the Hoopa area that the SO, Humboldt County Sheriff's Department, had been out with for the past several hours. And they anticipated that this event would go on for a number of hours and that they would need relief. So, um, he was mobilizing both the SWAT team to relieve their SET team and also the crisis negotiation team or whatever members we could come up with from our department to send to relieve their negotiators.

Q: Okay. Um, so getting back, you are on the hostage negotiation team.

A: Yes.

46
47 Q: Um, have you had any special training on that?
48
49 A: Yes, I have.
50
51 Q: Okay. What was that training?
52
53 A: The POST school in Monterey in October I think of last year.
54
55 Q: Okay. And, ah, since that incident, have you had a chance to, ah, deploy on a
56 hostage negotiation, ah, experience or SWAT call out?
57
58 A: Yes, three times.
59
60 Q: Three times – and you used your hostage negotiation skills on those – um, on
61 those calls?
62
63 A: Yes.
64
65 Q: Okay. So this is, um, the fourth call, ah, that you've had to deploy on as a
66 hostage invest...
67
68 A: Yes, specialized event, yeah.
69
70 Q: As a specialized hostage negotiator?
71
72 A: Correct.
73
74 Q: Okay. So you responded up to, um, the residence where, ah, the Sheriff's
75 Office had a, ah, barricaded [REDACTED]
76
77 A: That's correct. We – we responded to the command post there initially and
78 briefing.
79
80 Q: Okay. So what time do you – did you make it up to the command post with
81 the team?
82
83 A: I think it was about 130 in the morning of Monday morning, Sunday night.
84
85 Q: Oh one other question – how long you been a police officer?
86
87 A: Ah, since January of 1988.
88
89 Q: Okay. Okay. And, ah, so you responded to the command post. Ah, as a
90 hostage negotiator when you got to the command post, um, were you the

91 person that was in charge, ah, necessarily from the Eureka PD hostage
92 negotiation team?
93
94 A: From the Eureka side, yes, but...
95
96 Q: Yes.
97
98 A: ...but not at the incident, no.
99
100 Q: Okay. So, ah, and who else was with you that night?
101
102 A: Ed Wilson.
103
104 Q: Ed Wilson.
105
106 A: He's a police officer here also.
107
108 Q: Okay. So you and Ed, ah, came up to support the SWAT team, hostage
109 negotiations. Um, and so were you given any direct orders or commands once
110 you, ah – once you went up to the site at 2 am?
111
112 A: We were. We were briefed by their, um, negotiators or their two Sheriff's
113 Department deputies, um, one of whom's last name was (Daniels), and I'm
114 not sure who the other one is to tell you the truth.
115
116 Q: And he is a party of their hostage negotiation team?
117
118 A: I believe he is now.
119
120 Q: Okay. And, ah, any new information that they gave you regarding the
121 incident that you were not already made aware of?
122
123 A: Yeah.
124
125 Q: Okay.
126
127 A: Um, we were at the command post that they had set up there. And (JR
128 Covinsa) was there and was speaking with (Nova) and a couple of the SWAT
129 team members. And he advised us – and I happened to be in the room as a
130 negotiation team member – that the [REDACTED] had fired what they believed was
131 a total of four rounds at two patrol cars, which were positioned and – and still
132 at that time positioned, um, not directly in front of the [REDACTED] house but, ah,
133 within sight and not fire away. Um, those cars were still there, the rear most
134 of which was where they had kind of based their negotiators. Um, the forward
135 car they had SET team members positioned on the far side of it.

136
137 Q: Okay.
138
139 A: And on at least one occasion after beginning negotiations the [REDACTED] fired a
140 final round at – striking the hood and front windshield of the rear most car,
141 which is where they were gonna put us.
142
143 Q: Okay. And that's where they were already performing, um, the hostage
144 negotiations from that point or...
145
146 A: They had attempted hostage negotiations 'til the final round was fired, and
147 then they decided, um – and – and Ed Wilson and I talked about this also and
148 kind of at a roundtable discussion we all concurred – that rather than draw our
149 more, um, gunfire or volatile behavior, since there was no other place to put
150 anyone from the negotiation team or anyone from the SET team so that they
151 could actually see what was going on there, um, it was decided that we would
152 take up that position that – that, ah, Daniels had left with his partner and stay
153 quiet un – unless the [REDACTED] showed himself or indicated by some means that
154 he wanted to surrender, and then we would negotiate actively a surrender
155 phase.
156
157 Q: Okay.
158
159 A: But short of that, um, we would just take up a position there and – and keep an
160 eye out when we could, um, and otherwise be told by our SWAT team
161 members who were gonna take up the position at the forward-most vehicle –
162 and I believe that's actually north – oh, okay anyway, the SWAT team
163 members were at the forward-most vehicle. And th – they obviously had a
164 better line of sight. They were – could easily tell us if they saw him, in which
165 case we would go to the for – the front seat of the patrol car, activate the PA,
166 and begin a negotiation process.
167
168 Q: Gotcha. And – and was that something that, um – that, ah, you came up with
169 on your own, you and – you and Eddie, or was it, ah, an order given to you
170 or...?
171
172 A: No, that was a directive given to us by their negotiation team.
173
174 Q: Okay.
175
176 A: And the main reason that was for our safety 'cuz, if we had been sitting in the
177 front seat watching and waiting there, then we had no protection...
178
179 Q: Gotcha.
180

181 A: ...since it'd already been shot at once.
182
183 Q: Good deal. So if you can, mark with a pen where you were deployed and, ah,
184 where you ended up, um, going on the, ah, map that I gave you there.
185
186 A: We were deployed to this area right here.
187
188 Q: Okay. Can you mark that with number one?
189
190 A: Mm-hm.
191
192 Q: Okay. When you were in that position, ah, what – what time'd you finally get
193 to that position?
194
195 A: At about 0200.
196
197 Q: Okay. So at that time, 0200, ah, did you see anything at the house?
198
199 A: Um, there was a light on at – at this window, as near as we could tell.
200
201 Q: And that's labeled number, on the four side, B window.
02
203 A: B, mm-hm.
204
205 Q: Okay.
206
207 A: Um, but for safety reasons we took quick peeks and that's it because SWAT
208 team members were up here at the forward-most patrol car. And then I think
209 another team went down the hillside and made its way around. I don't know
210 where they were positioned.
211
212 Q: Ah, during the course, ah, that you were there watching that side, um, did you
213 have a chance to see the [REDACTED]
214
215 A: I saw movement in the number four side B window, but that's all, because our
216 job wasn't to actively watch the residence.
217
218 Q: Mm-hm.
219
220 A: It was to stay behind cover and be available for the negotiations, if the SWAT
221 team personnel told us we observed movement, he wants to come out.
222
223 Q: Gotcha.
24
225 A: So...

226
227 Q: So, ah, he never stuck his head out the window and said...
228
229 A: Not that I saw.
230
231 Q: ...he wanted to surrender.
232
233 A: No, not that I heard or saw, nor did – was I ever conveyed that message.
234
235 Q: Okay. And then the [REDACTED] that you saw on the inside, were you close
236 enough to make an identification of who that [REDACTED] was?
237
238 A: Oh absolutely not.
239
240 Q: Okay.
241
242 A: I couldn't have told you if man, woman, race.
243
244 Q: Okay.
245
246 A: Just movement in the – in the window.
247
248 Q: Move – like a – like a – like a, ah, shadow so to speak or just a figure?
249
250 A: Just a dark...
251
252 Q: Darkened...
253
254 A: ...figure moving.
255
256 Q: Is that because lights were on on the inside like you said, or was it...?
257
258 A: There were lights on, and – and our position was such that for me to – to have
259 gotten a good look, I would have needed binoculars, and night vision goggles,
260 and to move my position, which...
261
262 Q: What would you estimate as far as the – the yardage?
263
264 A: Ah, you know, it looked farther during the nighttime hours than it did during
265 the daytime hours...
266
267 Q: Mm-hm.
268
269 A: ...or when it started to get light. I'm gonna say maybe 40 yards.
270

271 Q: Okay. And then, um – so during, ah – was it a quiet night? Would you
272 classify it as a quiet night? It's the middle of a country.
273

274 A: Yeah.
275

276 Q: So did you ever hear anything coming from the inside?
277

278 A: I did not.
279

280 Q: Okay. Ah, based on your experience, you've worked nights for how many
281 years?
282

283 A: A number.
284

285 Q: Okay.
286

287 A: Probably 14 out of...
288

289 Q: And you've – you've responded to numerous burglary calls, so forth and so
290 on, domestic call, if someone was yelling for help inside or wanted to give up,
291 could you have heard them from your position?
292

293 A: I think we would easily have heard them because no one else on the perimeter
294 was making any noise. And – and certainly the people, the SWAT team
295 members at the forward vehicle, which was the plan, if they had heard
296 anything, they were to call for us, begin the negotiation process.
297

298 Q: So at...
299

300 A: And then...
301

302 Q: ...at any time you feel that, if the [REDACTED] wanted to give up, um, and he was
303 trying to make that vocal, that you – you could have heard it, your team could
304 have heard it?
305

306 A: Yes.
307

308 Q: Okay. Did anything – did anything change through the night? During the
309 dark time hours did you see anything, did you hear anything that, um – that
310 you recall that's pertinent to this?
311

312 A: No.
313

314 Q: Stand out?
315

316 A: There were, um, a couple of different points in the night where the SWAT
317 team members who were positioned at this vehicle...
318
319 Q: Mm-hm.
320
321 A: ...the forward-most vehicle, um, would say periodically we can see movement
322 in the window, ah, but that was all.
323
324 Q: But that was it. Okay. So kind of like the guy was walking around – you took
325 that as being the guy was walking around inside...
326
327 A: Yes.
328
329 Q: ...and, um, just goin' about his business. Did anyone say what time the
330 movement stopped or the last time anyone remembers, if you can recall that?
331
332 A: I think the – the last – well and this is – this is only what I heard – um, the last
333 identifiable movement that the forward-most SWAT team members said they
334 had seen was at about 4 or 430.
335
336 Q: Okay. At any time did you smell any smoke?
37
338 A: I did not.
339
340 Q: Okay. Um, to your knowledge were there...
341
342 A: I smelled breakfast...
343
344 Q: You smelled breakfast...
345
346 A: ...cooking.
347
348 Q: ...cooking.
349
350 A: But – but the wind was moving actually up the hill at that point, and there was
351 a trailer down here.
352
353 Q: Oh okay.
354
355 A: But that was at like 5 o'clock, 5, 520.
356
357 Q: Five o'clock in the morning, okay. So you imagine since the wind was going
358 up the hill...
59
360 A: Mm-hm.

361
362 Q: ...towards the house, it probably wasn't breakfast being cooked by the
363 [REDACTED]
364
365 A: I figured probably not.
366
367 Q: Did it smell good?
368
369 A: It did smell good.
370
371 Q: Yeah. Okay. Makin' me hungry. Um, okay, so nothing 'til daylight, then
372 daylight occurred. And did anything change at that point?
373
374 A: Not from the house – if – if anything, um, movement seemed to stop or at
375 least identifiable movement from – from the vantage point that the SWAT
376 team had. Um, and I think there was some conversation about maybe he's
377 gone to the back part of the house. But I don't know.
378
379 Q: Okay. Did you get a chance once daylight hit to look at the number four side?
380
381 A: Ah, no, o – other than – no more than I had seen before. What happened, as
382 daylight hit at about – well it started at about 5.
383
384 Q: Right.
385
386 A: It got much lighter. It then became very apparent that we were much closer
387 than we thought. And Sergeant (Nova) came up and said we're pullin' back
388 because his visibility is too good.
389
390 Q: Mm-hm.
391
392 A: From any one of the windows, um, it was pretty clear that he had the prime
393 spot for visibility...
394
395 Q: Mm-hm.
396
397 A: ...and protection.
398
399 Q: Mm-hm.
400
401 A: So we moved. There actually were two more patrol vehicles – these were
402 both SUVs...
403
404 Q: Yes.
405

406 A: ...unless – if that’s what these (unintelligible)...

407

408 Q: That’s – that’s what those are.

409

410 A: And then there was, ah, a Hoopa Valley Tribal Crown Vic...

411

412 Q: Okay.

413

414 A: ...back a little ways on this road and a Humboldt County Sheriff’s

415 Department – and there’s actually a bend – a big bend in this road. Yeah, I

416 never saw this driveway ‘cuz I never got close enough, if that’s the side of it

417 back there.

418

419 Q: Mm-hm.

420

421 A: Um, that – so there were two more Crown Vics here, an SO unit and a Hoopa

422 Valley Tribal. And we moved to the back of those because they were well out

423 of sight. And then I had no visual on that. Um, and I think the SWAT team

424 guys that had been here moved here because that offered the best concealment

425 (unintelligible)...

426

427 Q: Gotcha. So you – so you didn’t – pulled back...

428

429 A: Yeah.

430

431 Q: ...ah, to a much safer position...

432

433 A: Yeah.

434

435 Q: ...um, and kind of out of sight, ah, of the [REDACTED] who could have, ah – could

436 have engaged you without you seein’ him.

437

438 A: Right.

439

440 Q: Um, at any point, um, when you pulled back, ah, did you hear anything? Did

441 anyone signal to you, ah, that the [REDACTED] was giving up? Were there (sic)

442 hearing any sounds...

443

444 A: No.

445

446 Q: ...inside? Um...

447

448 A: And that’s based on the proximity of the SWAT team members who pulled

449 back to here because we were pretty much...

450

451 Q: Mm-hm.
452
453 A: ...constant verbal communication with them, but also the radio traffic
454 between other, ah...
455
456 Q: Okay.
457
458 A: ...SWAT team members positioned around.
459
460 Q: Ah, was there any significant information that was gathered, or obtained, or
461 anything like that by you, ah, or, um, anything like that during the daytime
462 hours about this incident?
463
464 A: No. And we were relieved at about 0700 hours.
465
466 Q: At zero seven – who relieved you at that time?
467
468 A: CDC.
469
470 Q: Do you remember any of the names of the people that relieved you?
471
472 A: (Higgerson) – Sergeant (Higgerson) was there.
473
474 Q: And who was gonna be tak...
475
476 A: And actually technically the person who relieved both Ed Wilson and myself
477 was Sergeant (Millner).
478
479 Q: Okay.
480
481 A: Um, but I have...
482
483 Q: Do you know S...
484
485 A: ...talked with Sergeant (Higgerson) before he was there, and so we...
486
487 Q: Okay. And then you don't know who – he – he's the – Sergeant
488 (Higgerson)'s the person in charge of Pelican Bay's, ah, negotiation team?
489
490 A: Negotiation, yeah.
491
492 Q: Do you know who was gonna be doing the negotiations actually?
493
494 A: I don't. And I don't know – to tell you the truth, I don't even know that they
495 had decided to begin active negotiations again or not.

496
497 Q: Okay.
498
499 A: That wasn't discussed, um, in my presence.
500
501 Q: Ah...
502
503 A: To my knowledge they were beginning to set up, um, and I assumed due to
504 the daylight, and proximity, and the visibility, and the [REDACTED] upper hand
505 and position, that they were gonna move all the entire negotiation center back
506 to a supply trailer that was, um, 30 feet from the command center.
507
508 Q: Okay. All right. Ah, anything else that you would like to add about this
509 incident, um, that you witnessed?
510
511 A: Nothing that I can think of.
512
513 Q: Okay.
514
515 A: I did see the damage to the patrol car, the SUV.
516
517 Q: You could see the...?
518
519 A: Yeah.
520
521 Q: Ah, what kind of damage did – did you see?
522
523 A: Ah, the one that we were positioned at – and I never went forward to this one,
524 the forward-most one – ah, had a spider webbed windshield. Um, and I was
525 told by (Daniels) from the SO that that was from, um, one of the rounds that
526 the [REDACTED] had fired at that vehicle.
527
528 Q: Did they tell you what – where the [REDACTED] fired from?
529
530 A: Ah, one of the windows of the house, and I didn't get which window. Ah, I...
531
532 Q: Gotcha.
533
534 A: ...I think there was some confusion because there were two different bouts of
535 gunfire.
536
537 Q: Mm-hm.
538
539 A: Um, and at the time that we talked to (Daniels) up at this point when he
540 walked us up to the point we were gonna take over, um, he was still a little,

541 um, unnerved I think by the event because he was there with his partner at – at
542 the point that the final round was fired. And...
543
544 Q: Mm-hm.
545
546 A: ...he said that – that was a lot closer than I've ever been to gunfire.
547
548 Q: Mm-hm.
549
550 A: That's not a good feeling. So I think he was a little, ah, unnerved by that.
551
552 Q: Right. Um, you were relieved about 0700.
553
554 A: Yes.
555
556 Q: Did you participate in anything after that? Ah, when – once you were relieved
557 did you leave, or did you stick around?
558
559 A: I – both Ed Wilson and I stayed around for about half hour or so. Um, but
560 there was no more – there was no debrief there. There was no, ah, real
561 transfer of information.
562
563 Q: So you...
564
565 A: It seemed that they had – there had been some kind of a plan, ah, which had,
566 um, been discussed and kind of round housed I think at the command trailer
567 prior to us being pulled out of where we were.
568
569 Q: Mm-hm.
570
571 A: Um, and that was – so it seemed pretty apparent that they had something in
572 mind, that they were gonna do some sort of plan. And that was already well
573 underway by the time they pulled us out.
574
575 Q: So at the – the time that the smoke was reported and the fire started you were
576 long gone.
577
578 A: We were long gone.
579
580 Q: Okay.
581
582 A: Long, long gone, yeah.
583
584 Q: Okay. So you never...
585

586 A: We headed down off the hill at, ah, right about 0800 I think.

587
588 Q: So you never, ah, heard the negotiations, you never heard – saw interaction
589 with the [REDACTED]

590
591 A: No, that is correct, I did not.

592
593 Q: Okay. I think that's it. Anything else, ([REDACTED])? Okay. It's, ah, 920, and, ah,
594 we'll conclude the interview. Thank you.

595
596
597 This transcript has been reviewed with the audio recording submitted and it is an accurate
598 transcription.

599 Signed _____

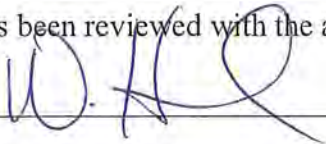
A handwritten signature in blue ink, appearing to be 'W. H. Q.', is written over a horizontal line that serves as a signature line.



HUMBOLDT COUNTY DISTRICT ATTORNEY'S OFFICE INVESTIGATION REPORT

DATE: July 2, 2007
CASE: HCSO #200703162

Witness: [REDACTED] Dispatcher, Eureka Police Department

DA Investigator: William Honsal

On June 7th, 2007 at 1620 hours, I interviewed dispatcher [REDACTED] [REDACTED] Eureka Police department, regarding HCSO case # 200703162. The interview was recorded on cassette and the following is a summary of her statement. For a detailed statement refer to attached transcript of the interview.

[REDACTED] is currently a Senior Dispatcher for the Eureka Police Department. She has been employed as a dispatcher with the city of Eureka for 5 years. Over the past 5 years she has taken numerous classes regarding dispatching and tactical dispatch. She is currently assigned as a tactical dispatcher for the Eureka Police Department SWAT team. She has attended 2 – 40 hour tactical dispatch schools and also attended a 24-hour tactical dispatch update class. She has also attended at 24-hour tactical dispatch conference. In all of these specialized training, she has learned how to properly dispatch and document a tactical callout. [REDACTED] has been called out on three prior tactical incidents, where her skills as a tactical dispatcher have been utilized.

On June 3rd, 2007, at 2019 hours, [REDACTED] received a page notifying her of a SWAT callout. Sgt. Bill Nova, Eureka PD SWAT Commander, advised that the Sheriff's office requested mutual aid regarding a barricaded [REDACTED] [REDACTED] notified the Team Leader, Officer Reyna-Sanchez and advised regarding her availability for the callout. Sgt. Nova advised EPD SWAT, Hostage negotiators and tactical dispatchers to be ready to deploy from EPD at 0030 hours.

[REDACTED] responded to EPD and the team deployed at 0030 hours. At 0300 hours the team arrived at the scene, Bloody Camp Road and [REDACTED] road. Upon arrival, [REDACTED] received orders from the SWAT commander, Bill Nova, to start a communications check on the [REDACTED] frequency and to check in at the Sheriff's command post. [REDACTED] responded to the command post and checked in with their tactical dispatch center. The sheriff's dispatcher was [REDACTED]. [REDACTED] was assigned to the radio and [REDACTED] was assigned to keep a incident log on the incident and to update officer positions on a plot map.

[REDACTED] started the log on 6/04/2007, at 0302 hours. Each line on the log documents the time, information source, the Action/Information/Occurrences, and who recorded that information. The log runs 14 pages and concludes on 6/05/2007 at 1603 hours. [REDACTED] documented every incident except on page 7 lines 7,8. At that time [REDACTED] was on a break and Lt. Cavinta entered the information.

([REDACTED] also documented the [REDACTED] actions/behavior on a log. The log started at 0304 hours and concluded at 1324 hours. The log documents every time officers broadcast over the radio regarding [REDACTED] movements and any action taken.

Refer to the attached dispatch log for specific details.

Disposition: Supplemental report referred to HCSO.

**EUREKA POLICE DEPARTMENT
WATCH COMMANDER'S DAILY REPORT**

ate: 060407

Day of Week: Monday

Watch Commander: NOVA

WATCH	OFFICER	I D	B E A T	V E H	R A D I O	C O D E	T A S E R	C H E C K	RECRUITS	REMARKS
									RIDE-ALONGS	(Court, flex, special assignments, etc.)
	NOVA	24	SWC							
	Wilcox	64	SW							
	Sanchez	83	SW							
	Johnson	43	SW							
	Jones	67	SW							- GA. Grenadier
	Harpham	49	SW							
	Hill	95	PR							
	Cooper	52	PR							
	AHC	89	PR							- C.A. Grenadier
		205	TD							
	Howden	40	CNT							
	Wilson	16	CNT							

Training

Absence

Comments
Loop Rd / Pine Creek rd 6.2 miles - Bloody camp rd.

Operational Issues

Administrative Issues

Commendations

SECTION 1 - INCIDENT PROFILE

Date of Incident: 060407 Time of Incident: 06307/1700

Location of Incident: [REDACTED] Hoop 9

Officers Involved, Last Name, First Name)	Assignment	Notes
1. NOVA, Bill	SWAT CDR	
2. Wilcox, Todd	Team Ldr	
3. Sanchez, Rigo	ATL	
4. Johnson, Mike	SWAT	
5. Jones, Tim	SWAT / C.A. Grenadier	
6. Harpham, Ron	SWAT	
7. Hill, Greg	Patrol Rifle	
8. Cooper, Gary	Patrol Rifle	
9. Altic, Louis	Patrol Rifle - C.A. Grenadier	
10. [REDACTED]	Tact. Disp.	
11. Howden, Kay	CNT	700 @ 0900 060407
12. Wilson, Eddie	CNT	
13.		
14.		
15.		
16.		
17.		
18.		

Perimeter(s)	Location	Comments
Inner Perimeter	Bloody Camp Rd.	Rd.
Outer Perimeter	"	"

Command Post	Location	Comments
S.W.A.T.	CP	- Bloodycamp Rd
C.N.T.	CP	- Bloodycamp Rd.
Fire		
Evacuation Site		
Medical Site		

Notifications	Responding	ETA	Comments
<input type="checkbox"/> W/C			
<input checked="" type="checkbox"/> S.W.A.T. Commander	On Scene		Bloodycamp Rd. CP
<input type="checkbox"/> CRU Cmdr.			
<input type="checkbox"/> Chief of Police			
<input checked="" type="checkbox"/> Fire/EMS	staged near the cross		Bloodycamp Rd. -CP

Radio Frequency	Frequency #	Established Y/N
Primary	[REDACTED]	Y
Tactical	HCSO main	

SECTION 2 – LOCATION OF INCIDENT

Address/Landmark: Bloody camp Rd.

Location Type (Check All That Apply)

<input checked="" type="checkbox"/> Building
<input type="checkbox"/> Conveyance
<input type="checkbox"/> Open Air
<input type="checkbox"/> Other

If Building, Select Type (Choose ONE)

<input type="checkbox"/> Commercial Building
<input type="checkbox"/> Government Building
<input checked="" type="checkbox"/> Single Family Residence <i>trailer</i>
<input type="checkbox"/> Town House/Condo/Apartment
<input type="checkbox"/> Other:

Number of Levels: 1

Number of Rooms: ~~4~~ 5

*3 bedrooms
1 bath
1 kitchen/living room*

If Building, Select Fortifications (Choose ONE)

<input type="checkbox"/> No Unusual Fortification
<input type="checkbox"/> Light Fortifications
<input type="checkbox"/> Heavily Fortified

If Conveyance, Select Type (Choose ONE)

<input type="checkbox"/> Sedan/Passenger Car
<input type="checkbox"/> Van
<input type="checkbox"/> Pick-up/Sport Utility Vehicle
<input type="checkbox"/> School Bus
<input type="checkbox"/> Commercial Bus
<input type="checkbox"/> Train
<input type="checkbox"/> Aircraft
<input type="checkbox"/> Other:

SECTION 3 – INCIDENT TYPE

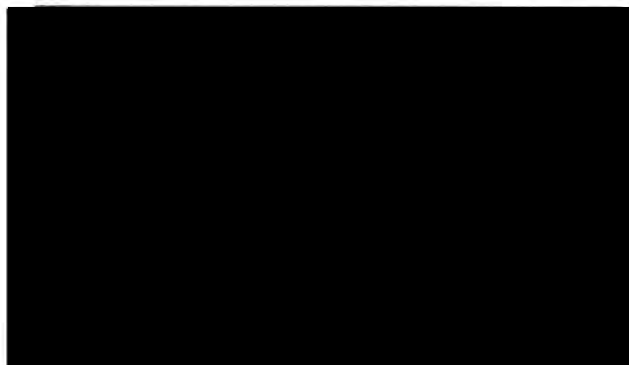
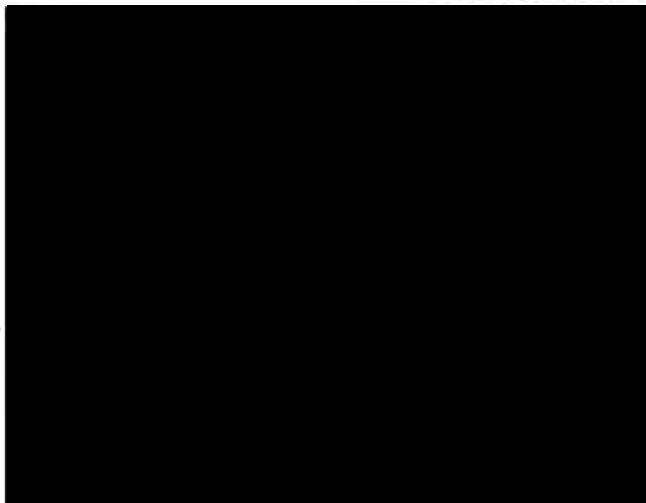

If Warrant, Warrant Type (Check All That Apply)
<input type="checkbox"/> Felony Arrest
<input type="checkbox"/> Search
<input type="checkbox"/> Other:

If Warrant, Reasons for Warrant (Check All That Apply)
<input type="checkbox"/> Explosives
<input type="checkbox"/> Firearms
<input type="checkbox"/> Narcotics
<input type="checkbox"/> Wanted Person
<input type="checkbox"/> Other:

If Barricade, Reasons for Barricade (Check All That Apply)
<input type="checkbox"/> Deliberate Hostage Taker
<input type="checkbox"/> Disgruntled Employee
<input type="checkbox"/> Disgruntled Employer
<input type="checkbox"/> Domestic Dispute
<input type="checkbox"/> Interrupted Crime in Progress
<input type="checkbox"/> Kidnap for Ransom
<input type="checkbox"/> Termination of Pursuit
<input type="checkbox"/> Warrant Turned Barricade
<input type="checkbox"/> Other:

SECTION 4 - [REDACTED] / [REDACTED] CONTINUED

Offender Activity

Number of Shots Fired by the [REDACTED] Prior to Deployment of the Tactical Team: 2 @ HCSD

Who Were the Shots Directed At (Check All That Apply)
<input type="checkbox"/> No One/Random
<input type="checkbox"/> Civilians
<input checked="" type="checkbox"/> Officers <u>HCSD</u>
<input type="checkbox"/> Structure
<input type="checkbox"/> Victim
<input type="checkbox"/> Other:

Firearm Offender Discharged (Check All That Apply)
<input type="checkbox"/> Handgun, Revolver
<input checked="" type="checkbox"/> Handgun, Semi-Auto
<input type="checkbox"/> Rifle, Bolt Action
<input type="checkbox"/> Rifle, Semi-Auto
<input checked="" type="checkbox"/> Rifle, Other
<input type="checkbox"/> Shotgun
<input type="checkbox"/> Full-Auto Weapon

Who was Injured or Killed by Offender's Actions (Check All That Apply)
<input checked="" type="checkbox"/> No One
<input type="checkbox"/> Offender
<input type="checkbox"/> Victim(s)/Hostage(s)
<input type="checkbox"/> Officer(s)
<input checked="" type="checkbox"/> Other: <u>Damage to 2 Tribal Vehs.</u>

[REDACTED] Demands

Demand Made	[REDACTED] Told PD Will Comply	Made Prior to Tactical Team Arrival	Comments
<input type="checkbox"/> None	<input type="checkbox"/> Yes <input type="checkbox"/> No	<input type="checkbox"/> Yes <input type="checkbox"/> No	<u>NO negotiations so far.</u>
<input type="checkbox"/> Cigarettes	<input type="checkbox"/> Yes <input type="checkbox"/> No	<input type="checkbox"/> Yes <input type="checkbox"/> No	
<input type="checkbox"/> Food	<input type="checkbox"/> Yes <input type="checkbox"/> No	<input type="checkbox"/> Yes <input type="checkbox"/> No	
<input type="checkbox"/> Money	<input type="checkbox"/> Yes <input type="checkbox"/> No	<input type="checkbox"/> Yes <input type="checkbox"/> No	
<input type="checkbox"/> Water	<input type="checkbox"/> Yes <input type="checkbox"/> No	<input type="checkbox"/> Yes <input type="checkbox"/> No	
<input type="checkbox"/> Transportation	<input type="checkbox"/> Yes <input type="checkbox"/> No	<input type="checkbox"/> Yes <input type="checkbox"/> No	
<input type="checkbox"/> Other:	<input type="checkbox"/> Yes <input type="checkbox"/> No	<input type="checkbox"/> Yes <input type="checkbox"/> No	

SECTION 5 – VICTIM / HOSTAGE

Number of Victims/Hostages Involved in Incident: _____

Enter Victim/Hostage Profile Information for Each Victim/Hostage. If More Than Three Victims/Hostages, Reproduce This Section.

#1 Victim/Hostage Profile

Name: (optional) _____

Gender: M F Age: _____ Race: _____ Height: _____ Weight: _____

Relationship to Offender (Choose ONE):

<input type="checkbox"/> None/Stranger
<input type="checkbox"/> Family Member (specify):
<input type="checkbox"/> Employer

<input type="checkbox"/> Acquaintance
<input type="checkbox"/> Employee
<input type="checkbox"/> Other (explain):

Photo [] Yes [] No

#2 Victim/Hostage Profile

Name: (optional) _____

Gender: M F Age: _____ Race: _____ Height: _____ Weight: _____

Relationship to Offender (Choose ONE):

<input type="checkbox"/> None/Stranger
<input type="checkbox"/> Family Member (specify):
<input type="checkbox"/> Employer

<input type="checkbox"/> Acquaintance
<input type="checkbox"/> Employee
<input type="checkbox"/> Other (explain):

Photo [] Yes [] No

#3 Victim/Hostage Profile

Name: (optional) _____

Gender: M F Age: _____ Race: _____ Height: _____ Weight: _____

Relationship to Offender (Choose ONE):

<input type="checkbox"/> None/Stranger
<input type="checkbox"/> Family Member (specify):
<input type="checkbox"/> Employer

<input type="checkbox"/> Acquaintance
<input type="checkbox"/> Employee
<input type="checkbox"/> Other (explain):

Photo [] Yes [] No

DEPARTMENT ACTION LOG

Date: 060407

Page: 1

Incident #: _____

Time	Info Source	Chronological - Action/Information/Occurrences	Records
0302	HCSO	CNT moving down	
0311	HCSO	Garcia entrt with 52 + 49.	
0313	HCSO	Queneau moving EPD up.	
0337	49	Cooper I'm gen coming in from behind	
0340	L24	Imm. threat. [REDACTED] wgun approaching. Rules of engagement.	
0346	L24	2 of 3 teams in place.	
0352	L24	we still have one team awaiting a guy in place.	
0400	L24	I am moving up to K64's position.	
0403	L24	L24 64 I'm coming up on your 6.	
0405	HCSO	Team 2 out CP -	
0407	HCSO	Miller entrt Team 3 (Bishop/Ireland) location	
0413	49	L24 we have had extensive movement on what we believe is the 2 side of the house	
0419	K64	L24 we are going to move up. There is another tree in front of this one.	
0419	L24	rgr. take it slow and easy.	
0424	49	L24 we have poor position for day light because there is a tree located in front of the house. neither near or further are any positions that will work.	
0424	49	Fall back to a position to cover poor side.	
0424	L24	I can find a position possibly to provide containment. but I will lose visibility because the tree of window and lose visibility of the door.	
0425	49		

DEPARTMENT ACTION LOG

Date: 060407

Page: 2

Incident #: _____

Time	Info Source	Chronological - Action/Information/Occurrences	Recorder
0425	L24	Get a good cover fallback position Safety is priority.	
0425	49	Put we ^{can} back up the truck 70 yards, but I'm	
0425	49	concerned about the tactical element. Only one person to cover retreat, and it	
0426	49	may cause him to start firing.	
0426	49	We will wait until the last min. when HCSO returns to help cover.	
0426	L24	Copy. Be prepared to do it on your own.	
0437	K64	L24, we have decent visual on window A. L24 copy.	
0442	83	83 pure static. L24 copied.	
0448	L24	64, exit back to our position.	
0448	K64	low volume.. much better place to deploy C.A.	
0448	L24	Copy. you are going to have nautical	
0448	L24	Sunrise back lighting you bad in 20 mins.	
0449	L23	Be advised we have loud.. static low volume -acknowledge by L24.	
0454	L23	L24, moved back to the 1st tree. In position again.	
0454	L24	copy we have movement B-window	
0455	L24	All units we have movement 4 side window B. 4 side window B.	
0457	49	L24 and other units we are going to be starting up a truck and trying to back	
0457	49	it out.	
0457	L24	Rgr. movement 4 side opening B-boy 4 side opening B-boy.	

DEPARTMENT ACTION LOG

Date: 060407

Page: 3

Incident #: _____

Time	Info Source	Chronological - Action/Information/Occurrences	Recorder
0459	unil	static transmissions X 2. unreadable	
0500	L24	copy	
0501	L24	We got light B opening H side U side B opening	
0501	L24	64 L23 exit back to jump point.	
0502	49	83 (pure static) movement complete. lost a little on the alcove. we have windows	
0502	49	on 2 side and 1 side.	
0502	unil	pure static - 83 acknowledging (?)	
0509	L24	Returning to TOC. Appears lights are out in the house at this point.	
0522	K64	out TOC.	
0608	L24	Situation Report request. 52+49 - situation same as before c4	
0608	K64	83+89 - c4	
0618	K64	We have re-established visual on window A side 4.	
0650	L24	64 I'm coming in on you 6.	
0657	L24	83+49 we are going to do an evolutionary changeover starting in 30 or 45.	
0756	HCSO	moving in to release EPD	
1001	R05	Comm. Check complete. units enrt to Staging location	
1010	avinta	REACH Has an eta 115min. contacting CHP. (ALS)	
1110	HCSO	HCSO Team 1 on side 4/3 HCSO Team 2 on side 1/2	
1010	HCSO	Lundie/Ireland on side 2/3 Sniper on side 2/3 + 1/2	

DEPARTMENT ACTION LOG

Date: 060407

Page: 4

Incident #: _____

Time	Info Source	Chronological - Action/Information/Occurrences	Recorder
1010	CDC	CDC Staged IFO TOC. 1 CDC unit in TOC	
1043	HCSO	REACH refered us to CHP, CHP Declined. CDF will roll if needed. Meet at	
1043	HCSO	Valley Floor in Hoopa. (Hoopa Airport) 2nd. [REDACTED]	
1048	L24	They are giving options now.	
1051	XIO	communications began 5 ago.	
1052	XIO	If communications halted, options will begin at 1105	
1102	XIO	communications started	
1107	XIO	communications halted	
1110	CDC	CDC repositioned IFO TOC.	
1111	XIO	communications int.	
1112	XIO	confirmed clear to enter gas.	
1112	HCSO covinta	Affirmative. mass check.	
1114	XIO	Be advised gas is going initiated.	
1119	XIO	5 in to the A/B windows 4 side	
1121	HCSO covinta	XIO in 5 mins. reload 5 in A+B.	
1122	XIO	3883 enrt to Irelands location (2/3 side)	
1124	HCSO	3883 out with Ireland	
1126	XIO	2nd volley started	
1128	HCSO covinta	code 33 / HCSO main	

DEPARTMENT ACTION LOG

Date: 060407

Page: 5

Incident #: _____

Time	Info Source	Chronological - Action/Information/Occurrences	Records
1132	X10	Rounds entered, no movement	
1135	HCSO covinta	Confirm no movement?	
1135	X10	Broken window 1 side.	
1135	HCSO covinta	move to 1/2 side 5 ^{enter} 5 into Masterbedrm	
1136	Bishop	movement into the the 2 side window	
1137	Bishop	bedroom ■■■ crawling on the ground.	
1137	X10	move EPD up for volley on side 2. we are out.	
1139	X10	EPD moving into place will notify when there	
1140	HCSO covinta	Prepare for another Surrender order	
1141	HCSO covinta	immediately after 5 volleys	
1147	CDC	5 additional CDC ofc. and ^{ent.}	
1156	K64	Raise Bishop.	
1156	K64	We need to come up square on 2 side	
1156	K64	We don't know where you are.	
1156	Bishop	I have a visual on the window on the 2 side and front door.	
1157	K64	what is your range?	
1157	Bishop	105 yards	
1200	K64	Bishop. confirm if we stay east of the barbed wire fence we will not be in your	
1200	K64 Bishop	Field of fire? Bishop. Affirmative, K64 moving	

DEPARTMENT ACTION LOG

Date: 06 04 07

Page: 6

Incident #: _____

Time	Info Source	Chronological - Action/Information/Occurrences	Recorder
1203	K64	67 - 84 yards that is it	
1203	67	HCSO gas team. At your distance how high are you aiming?	
1203	HCSO	At the top edge of the window.	
1204	K64	67 I am coming back to you.	
1206	L24	K64, 5 good rounds. 1st volley misses. 2nd volley of [redacted] with imm. fu	
1206	HCSO COVINTA	X10 imm. following EPD 10 volley go with 10 of our own. on our side.	
1206	X-10	X-wind. 12 ga.	
1208	X10	Going w 110.	
1209	L24	K64 once in place advise approx. distance	
1209	HCSO COVINTA	Both warrants signed along with Raimey	
1210	67	81 yards	
1210	L24	67 proceed when ready 67 roger.	
1211	L23	Stand by team is in position	
1213	K64	we are masking. will advise when we begin deploying.	
1218	K64	Proceeding with gas:	
1218	Visual	[redacted] @ TOC.	
1219	K64	we have 3 into the room.	
1220	67	we are pushing limits of the equipment we have 3 more now.	
1221	L24	67. 4 more when the HCSO is done,	

DEPARTMENT ACTION LOG

Date: 060407

Page: 7

Incident #: _____

Time	Info Source	Chronological - Action/Information/Occurrences	Recorder
1222	X10	we are done.	
1222	L24	67 go ahead with 4.	
1222	67	It is in.	
1224	67	we have 4 in	
1224	HCSO Covinta	67 go ahead with surrender order S X10 for 15 mins.	
1224	HCSO Covinta	CODE 33 cancel. HCSO main	
1237	64	POOR RANGE FOR FURTHER ABENT ON #2 SIDE. REQ. TO RETON #3 SIDE DODGES FOR BETTER RANGE -	JR
1239	+10	BROADCASTS CEASING -	
1239	BISHOP	NEW MOVEMENT SIDES TWO	
1240	K64	leaving 52, L23, 49 side 2 K64, 67, 89, T95 recon side 3	
1246	HCSO Covinta	X10 continue commands for 5 minutes. no movement on the 2 or 4 side	
1253	L23	83 confirm you heard that too? static. L23 banging noises heard. no visual on sup	
1254	L23	83 has visual 213 side. I only have 3 side	
1254	Bishop	movement side 2 [redacted] uncovered himself with a large thick blanket.	
1257	L23	per 83 movement pass. coming from 213 corner. Bishop confirmed.	
1255	L24	K64 ETA on deployment on side 3. K64 moving in. L24 4.37 spaced.	
1258	L24	K64 int. deployment. when set advise us.	
1258	K64	We are about 5 out.	

DEPARTMENT ACTION LOG

Date: 060407

Page: 8

Incident #: _____

Time	Info Source	Chronological - Action/Information/Occurrences	Recorder
1304	67	83 we will be at your 5 o'clock just above you. MASKING now.	
1307	X10	We will have to break a pane of windows then attempt w/ 12g. to get 2nd pane to break	
1308	X10	then re evaluate for wants for C.S. grenade (parrots.) Prepare for port-covinta.	
1308	67	Ready to gas	
1309	67	commencing gas	
1311	67	4 in. - 3 side.	
1311	X10	porting window	
1314	X10	able to partially break the window but can't get a grenade through.	
1315	X10	There is a fence between us and the house hard to move up safely. We need 1 sniper	
1315	X10	on the 4 side to cover move.	
1317	67	Do you want us to deploy rounds 2/3 side closest corner?	
1319	L24	67. Hold and cover	
1320	CDC	4 CDC with 1 Squad leader. (2 of 4 are Snipers)	
1320	DA Hislop.	Advises his wife spoke with anonymous rp stating possible C4 inside. Det enrt 2 interview Matt Moore seen with	
1322	HCSO covinta	X10 advised of above information	
1324	X10	Be advised large handgun seen on a shelf on Side 4 Window A.	
1330	X10	CDC in place. 1/4 corner opp. window A 1 canister. Window B 1 canister retreat	
1330	X10	same way. CDC with cover from veh. waiting for your go. (elusive blanket used)	
1331	HCSO covinta	clear and proceed.	

DEPARTMENT ACTION LOG

Date: 060407

Page: 9

Incident #: _____

Time	Info Source	Chronological - Action/Information/Occurrences	Recorder
1338	X1	X10'S team is moving up.	
1339	X1	Team is halfway to the residence.	
1340	X1	Team is at window A gas inserted.	
1340	X1	Gas inserted into window B retreating back	
1340	HCSO Covinta	Fridley advise to start surrender commands.	
1341	X1	Team is back.	
1344	HCSO UNK.	product discharged from canisters. communications (surrender)	
1348	L24	Good deployment. confirm large ca. handgun S-4 W-A	
1350	X10	CDC advises they have more flameless canisters if needed.	
1352	L24	67 do we have any pyro. c. s.	
1352	67	64 can check. we have non-pyro and aerosol. - mike lights	
1353	K64	negative	
1355	X10	CDC enrt w/ blanket & halogens.	
1356	L24	67 confirm you have some mighty/mights with you.	
1356	K64	negative for 67. 67 L24, in the truck	
1357	67	w/ bearing vest + 1 pyro PKT grenade.	
1359	L24	67/64 what hand held do we have with the team down there.	
1359	K64	4 aerosols - CS	
1400	K64	Do approach to 2/3 corner or 2 side has a lot of open ground, not desirable	

DEPARTMENT ACTION LOG

Date: 060407

Page: 10

Incident #: _____

Time	Info Source	Chronological - Action/Information/Occurrences	Recorder
1401	67	64, approach on to 2/3 corner, big ^{large} window we ported on side 2.	
1403	HCSO Cavinta	CDC ent w/ the blanket and vest. for deployment Side 4 Window A & B.	
1406	K64	advised X-10's deploying side 4 A/B.	
1408	CDC	Blanket got to 2 vans getting ready for deployment.	
1411	83	67 rgr. covering.	
1415	HCSO 27 Sles.	no CH. on LSD + meth.	
1417	X1	Team is moving forwarded. masked up.	
1417	X1	Team is halfway to residence.	
1418	X1	Dog on scene. Smoke introduced to window A	
1419	X1	Team at window B smoke intr 2 times Team standing by unit if canister went in	
1419	X1	Team moving back smoke coming from both windows.	
1420	L24	once X10 team is back have them go and staff announcements.	
1420	X1	Team is back. Starting announcements.	
1421	X10	Both canisters successfully deployed (window A) B-window sting ball introduced.	
1422	X10	Smoke coming out of roof vents.	
1428	X1	communications ending.	
1430	L24	To perimeter units to you have any movement	
1431	67	67 nothing on #3 HCSO nothing on #1 L23 nothing on #2	
1432	X10	Any smoke on #2 side? Garcia - none on #2 or #1 side	

DEPARTMENT ACTION LOG

Date: 060407

Page: 11

Incident #: _____

Time	Info Source	Chronological - Action/Information/Occurrences	Recorder
1436	L24	we have fire int. verbal surrender comb's. notify fire. perimeter unit	
1437	L24	maintain maximum surv. 67 side 3 team holding.	
1437	RD5	Fire staging where TOC was. TOC relocated to bloody/camp Rd.	
1440	L24	Code 33 main	
1441	Wayne Hansen	Black smoke coming out	
1444	CDC	Smoke is increasing in volume	
1444	CDC	Black smoke.	
1445	L24	Continuing w/voice order for surrender no compliance.	
1445	HCSO	Window on <u>side 1</u> completely black cannot see in. Appears to be moving back	
1446	HCSO	towards #2 side.	
1447	CDC	Still black smoke getting worse.	
1447	CDC	No flames, smoke <u>side 4</u> window B window A-black	
1449	67	A window <u>3 side</u> completely black	
1449	64	B window <u>4 side</u> something changing. something fell off window and now	
1449	64	it is changing color. NO movement	
1450	L24	Smoke at <u>4A + 4B</u> openings.	
1451	Garcia	Bishop radio is dead moving one to him. Side 2 main door - best view	
1451	Garca	Miller transporting radio	
1452	CDC	Black smoke side 4 windows A + B	

DEPARTMENT ACTION LOG

Date: 06/04/07

Page: 12

Incident #: _____

Time	Info Source	Chronological - Action/Information/Occurrences	Recorder
1455	L24	no change.	
1459	CDC	Smoke is getting darker and more intense.	
1500	CDC	movement side 4. ? - Glass fell out of window B. majority of smoke.	
1501	CDC	Side 3 window A lots of smoke.	
1502	Wayne Hansen	Sheriff notified.	
1503	CDC	<u>Side 3</u> , window B Smoke coming out	
1504	89	<u>Side 3</u> window B - Banging inside / CDC Shots F Poss inside	
1505	L24	<u>susp</u> <u>side 4</u> <u>window B</u>	
1505	L24	Smoke intensifying. rounds cooking off or shots inside	
1506	49	2 attempts at gas I heard bumping inside Side 2 window B.	
1507	T95	Smoke coming out of vent 2/B	
1509	T95	Roof vent 3 A/B vent	
1510	810	1/4 all along roof.	
1510	X10	NO VISUAL	
1511	L24	L24 A7 returning to TOC. no visual	
1511		Team 2 has visual 1/2	
1511	CDC	lost all visual. Hearing fire crackle inside house. <u>Side 4</u>	
1513	Team 2	2 thumps inside unk if fire related.	

DEPARTMENT ACTION LOG

Date: 060407

Page: 13

Incident #: _____

Time	Info Source	Chronological - Action/Information/Occurrences	Recorder
1513	67	no visibility # 3	
1513	Garcia	1/2 still clear	
1514	Garcia	No smoke out of side 2 window	
1515	CDC	Flames on 4 window A/B	
1515	mass.	CDC with us. side 3	
1515	CDC	Flames side 3	
1516	49	Smoke purging window 2 (side 2)	
1516	49	Lost visibility in room. Poss in attic rolling down	
1517	CDC	Side 4 (Kitchen) totally involved	
1521	HCSO	Car parked in driveway 10 yds. from house	
1522	CDC	Fully involved - whole trailer	
1524	comm HCSO	(moving) fire trucks in to get other vehs (walking)	
1524	Garcia	Smoke exiting front door.	
1527	X1	can you have someone run a can of paint down here.	
1527	164	EPD TK poss has paint.	
1530	Tecum 2	Still no smoke # 1 or # 2	
1531	A9	check w/A1 see if there is a propane tank	
1532	unk HCSO	North # 3 side propane tank	
1532	unk HCSO	5 gallon by stair # 1 side	

[REDACTED] ACTIONS/BEHAVIOR LOG

Date: 060407

Page: 1

Incident #: _____

Code Violations	Threat Conditions
	<u>Weapons - Shots Fired - Hostages - Acts of Violence - Potential Acts of Violence</u>
	Threats of Violence - Demand Deadlines- Evacuations
	Animals - Explosives/Toxic Materials - Escape Movement From Scene
	Suicide Potential - [REDACTED] [REDACTED] Other

Time	Info Source	Chronological - Action/Information/Occurrences	Recorder
0304	HCSO	[REDACTED] stated "Bring the flashlight to me!"	[REDACTED]
0318	HCSO Bishop	Shining a flashlight	[REDACTED]
0413	49	L24 we have extensive movement on what we believe is the 2-side of the house	[REDACTED]
0454	L24	movement B window	[REDACTED]
0455	L24	All units we have movement 4-side window B. 4-side window B.	[REDACTED]
0457	L24	movement 4-side opening. B-boy. 4-side opening B-boy	[REDACTED]
0510	unit	pure static. (Due to L24 saying we movement returned opening-B	[REDACTED]
0500	unit	4side) possibly advisement of movement at a different location.	[REDACTED]
0501	L24	We got light B-opening 4-side. 4-side B-opening.	[REDACTED]
0509	L24	Appears lights are out in the house at this point.	[REDACTED]
1135	X10	Broken window 1 side	[REDACTED]
1136	Bishop.	movement in the 2 side window bedroom [REDACTED] crawling on the ground.	[REDACTED]
1238	unit	Broad casts ceased	[REDACTED]
1253	83 L23 Bishop	All heard noise on 2/3 side. Banging. Bishop-movement side 2 [REDACTED] uncovered	[REDACTED]
1253	"	himself with a large blanket	[REDACTED]
1224	X10	Large handgun seen on shelf Side 4 Window A	[REDACTED]

INTERVIEW WITH [REDACTED] [REDACTED]
Q=Bill Honsal
[REDACTED]

1
2
3
4
5
6
7
8
9
10
11
12
13
14
15
16
17
18
19
20
21
22
23
24
25
26
27
28
29
30
31
32
33
34
35
36
37
38
39
40
41
42
43
44
45

Q: Uh, this is Bill Honsal with Humboldt County District Attorney's Office interviewing [REDACTED] [REDACTED] regarding the Hoopa, uh, S.W.A.T call incident that occurred on 6/4/07. Um, [REDACTED] could you spell your last name for the record?

A: [REDACTED]

Q: Okay. And, uh, currently how are you employed [REDACTED]

A: I'm a Senior Communication Dispatcher for Eureka Police Department.

Q: Okay. And, um, what, uh, how long have you been a dispatcher?

A: For five years.

Q: Have you had special training as a dispatcher?

A: I have.

Q: Okay. Can you just summarize your training over the last five years?

A: Um, I attended a 40-hour basic dispatching course. I've attended numerous courses on dispatching. I've attended courses for hostage negotiations as well as tactical dispatching.

Q: Okay. So, uh, hostage negotiations and tactical dispatching. Um, currently are you, um, recognized as a, um, tactical dispatcher that aids your S.W.A.T. team?

A: Yes, I am.

Q: Okay. On the third of June 2007, uh, were you notified about an incident in Hoopa?

46 A: Yes, I was.
47
48 Q: Okay. Could you tell us how you were notified of that?
49
50 A: Via pager:
51
52 Q: Via pager. And, uh, what, uh, what did you do in response to that page?
53
54 A: Um, I contacted the team leader, um, (Rodriguia Raina Sanchez). He was
55 then going to contact the Commander Sergeant (Nova) and then I contacted
56 my tactical dispatch..
57
58 Q: Okay.
59
60 A: ...Supervisor [REDACTED]
61
62 Q: Okay. And at that time...
63
64 A: (Unintelligible).
65
66 Q: We're going to go off tape just for a second. Back on tape. And, okay, so you
67 were talking about how you were notified and then you were notifying your
68 supervisor, uh, that there was this incident?
69
70 A: Right, we have a buddy system and the page said, to all, phone Sergeant
71 (Nova). So I thought that would bog it down if we all did. So, um, I was
72 waiting to hear back from Officer (Sanchez) and then attempting to contact,
73 uh, my Supervisor [REDACTED] with no luck.
74
75 Q: Okay. Um, so at some time, did you, uh, where were you at that time?
76
77 A: I was on Highway 36 driving.
78
79 Q: Okay. So, you were off duty...
80
81 A: Yes.
82
83 Q: ...at that point? Okay. So did you respond anywhere, were there any
84 directions given to you?
85
86 A: Um, Officer (Sanchez) was going to contact Sergeant (Nova) so I was waiting
87 for him. I drove home to get all my equipment. Um, by the time I got to
88 Eureka he had called back and he had given me the information that Sergeant
89 (Nova) had given him.
90

91 Q: Okay. And what was that information?
92
93 A: Um, that we were going to be meeting at 0030 at headquarters to brief on, uh,
94 barricaded [REDACTED] that was in Hoopa and had fired shots at deputies and that's
95 all I had.
96
97 Q: Okay. And so at 0030 hours, um, did you leave then, uh, EPD with the
98 S.W.A.T. Team and travel up to Hoopa?
99
100 A: Yes, I did.
101
102 Q: Okay. Once you made it up to Hoopa - do you remember approximately a
103 time that you made it up there?
104
105 A: It was about 0300 give or take five minutes.
106
107 Q: Okay, you got there. Did you receive any orders once you were there?
108
109 A: I did from Sergeant (Nova).
110
111 Q: Okay. What were those orders?
112
113 A: Um, to start a communications check on ([REDACTED]) and enter the clock and
114 contact their tact - their sheriff's department tactical dispatcher to see where
115 they were at.
116
117 Q: Okay. So at that time you talked to the sheriff's dispatcher - and who was
118 that?
119
120 A: [REDACTED]).
121
122 Q: Okay. And you were updated on the current status?
123
124 A: I was.
125
126 Q: Okay. At that point, um, were you given any tasks by...
127
128 A: By [REDACTED]
129
130 Q: ... [REDACTED]
131
132 A: No, she had told me where her officers were at. I copied down a deployment
133 of her officers. And I think we waited until - I think it was - I want to say 13
134 (Whirl Quarnell) took our guys in and it just kind of floats.
135

- 136 Q: Okay. So, what were your responsibilities then, uh, when you initially, uh,
137 responded to dispatch after you talked to, uh, [REDACTED] and, uh, what were your
138 responsibilities at that point and then just tell us how they changed, uh,
139 throughout these - this operation?
140
- 141 A: Okay. My responsibilities were to keep a running log of all the radio
142 transmissions to - we have a plot map as to where the incident is at, so to
143 update that plot map when the teams were moving - when the officers were
144 moving to a different location. Any notifications that Sergeant (Nova) needed
145 to be made, I made and pretty much just assist him in any way that I could.
146
- 147 Q: Okay. So you - you - you, um, you brought up a - an incident log?
148
- 149 A: Yes.
150
- 151 Q: Okay. And, um, what I'm going to do is give you this. This is the incident log
152 that the - these officers received from, um, from the team leader (Bill Nova)
153 and it's several pages. Um, this - the first entry, um, 0302 hours, um, is that -
154 is that the first entry that you put down on the log?
155
- 156 A: Yes, it is.
157
- 158 Q: Okay. And, um, and this is - these are your initials to the far right when it
159 says recorder [REDACTED]?
160
- 161 A: Yes, that is.
162
- 163 Q: Okay. So, can you just take a moment and flip through this log and verify that
164 you made every entry, uh, on this log?
165
- 166 A: Um, I know I didn't make every entry. On Page 7...
167
- 168 Q: Okay.
169
- 170 A: ...at 1237, I exited the command post to go to the restroom...
171
- 172 Q: Okay.
173
- 174 A: ...so I believe that Sergeant (Conventa) or Lieutenant (Conventa) entered.
175 There appears to be two entries and the rest are all mine.
176
- 177 Q: Can you - um, maybe ones out of order there.
178
- 179 A: Oh, that's the [REDACTED] action.
180

181 Q: Oh, [REDACTED] action.
182
183 A: Yeah.
184
185 Q: Okay. So on the log, uh, can you just tell us the last time you ended the log
186 and then - then what that was?
187
188 A: It was at 1603 by Sergeant (Nova) for - we were standing by for our release
189 order.
190
191 Q: Great, okay. And so there's something else attached to that, uh, the last page
192 you said the [REDACTED] actions?
193
194 A: Correct.
195
196 Q: Okay. Can you tell us what that form is - is about and - and, uh, for?
197
198 A: This form is like the department actions, any time the [REDACTED] does anything,
199 whether it's movement inside or says anything or anything that a [REDACTED] does
200 that's broadcasted across the radio is written down of their action or behavior
201 log.
202
203 Q: Okay. And, um, again on the far right - this starts at 0304 hours and, um, and
204 the far right it says recorder and then it's your MO and there's a list all the way
205 down except it looks like one entry three quarters of the way down. All those
206 MO's, those are - those are your entries?
207
208 A: That's correct.
209
210 Q: Okay. Can you tell us the last time an entry was made in that log and what
211 time and what it was?
212
213 A: An entry was made at 1320 by (X-10), who was (Quarnell) with the Sheriff's
214 Department, and he had made a transmission that a large handgun was seen on
215 a shelf on Side-A win - (Cripton) Site 4, Window A, atom.
216
217 Q: Okay. Okay. Thank you. Um, now regarding, um, tactical instance where
218 you have, um, actually done an action log and a [REDACTED] actions log, how
219 many times have you done this in the past?
220
221 A: This is, I believe, the third time.
222
223 Q: The third time, okay. And did you receive any specialized training as oppose
224 - as - as far as log-in times and - and, uh, logging down what - what has been
225 said?

226

227 A: Yes, I did.

228

229 Q: Okay. And what was that training?

230

231 A: Um, two tactical dispatch basic courses - both 40-hour courses. And one
232 tactical dispatch update course, which was 24 hours. And then I attended a
233 tactical dispatch conference, um, which was I - probably about 24 hours all
234 together just on different topics.

235

236 Q: Okay. And, um, eh, let me think what else? Do you have anything else to
237 add, uh, about, um, the incidents, anything else that you were in charge of,
238 um, that would be prevalent in this case?

239

240 A: No, I do not.

241

242 Q: Okay. Uh, oh, one more question. Um, the time that's on the far right, how
243 did you get that time- every time there was s - there was a log-in to be made,
244 you write a time?

245

246 A: The time on the far left?

247

248 Q: Yes, on the far left. How was that - where did you look to get that time?

249

250 A: There is a digital clock that sits above where the dispatcher sits and the
251 sheriff's department command post that I took the time off of every time...

252

253

254 This transcript has been reviewed with the audio recording submitted and it is an accurate
255 transcription.

256 Signed

